

LDX Series

2021 Cameras, Transmission and Accessories Catalog



LDX 86^N Series (Fully Native HD/3G/4K/High-Speed with optional HDR)

The LDX 86^N Series delivers native HD, 3G and 4K images for the highest possible resolution and image clarity. The LDX 86^N Series lets you grow into the formats you need tomorrow while buying only what you need today. With a daily, weekly or perpetual GV-eLicense upgrade path, you can move from any single speed HD/3G format to 4K — from single speed HD/3G to 6X HD/3G speed — and even a camera that can switch between higher resolution and higher frame rate. Optional native high dynamic range (HDR) for single-speed operation is available via a perpetual GV-eLicense.

The key to providing native resolution in the LDX 86^N Series is a new generation of native 4K Xensium^{HAWK} CMOS imagers that support full native 4K resolution as well as native HD resolution. This new 3840x2160p 4K Xensium^{HAWK} CMOS imager offers a unique pixel technology called DPM^{Ultra} (dynamic pixel management) functionality. With DPM^{Ultra}, the camera also provides native 1920x1080 HD acquisition inside the imager (by combining two horizontal and two vertical adjacent pixels) without the intrinsic downsides of 4K acquisition, such as rolling-shutter and decreased sensitivity, while delivering native 4K crispness when needed.

Unlike other “native” 4K acquisition solutions, these new imagers use a true 16:9 aspect ratio with a native 3840x2160p UHD pixel count, so lenses perform as intended for all broadcast applications.

The five models in the LDX 86^N Series follow the same familiar daily, weekly or perpetual GV-eLicense upgrade path as the LDX 86 Series, culminating in the LDX 86^N Universe with all native format acquisition for 1920x1080 and 3840x2160 with a simple menu command allowing you to switch between 4K (1X speed), 3G (1X/3X/6X speeds) and HD (1X/3X/6X speeds), complete with standard 1X HD outputs for simultaneous live use.

Super Slow-Motion

The four LDX 86^N and LDX 86 (see below) high-speed cameras set a new standard in image acquisition for slow-motion instant replay. They capture fast-paced sports action and emotion with unrivaled quality levels at high frame rates and with instant time-to-air. All captured frames can be permanently recorded, so not a single moment will be missed or lost.

LDX 86 Series (High Sensitive HD/3G/4K/High-Speed with optional HDR)

The LDX 86 Series of cameras offer the perfect solution for all format requirements, especially when light sensitivity is of prime importance. Acquiring in native 1920x1080, the LDX 86 4K and LDX 86 Universe cameras use a unique closed-system process for 3840x2160 UHD where all of the processing takes place within the camera system. This delivers a 4K image with the highest light sensitivity available in any system camera, with images almost indistinguishable from native 4K acquisition in most applications.

The single speed and high-speed cameras in the LDX 86 Series are upgradeable with a daily, weekly or perpetual GV-eLicense to the flagship of the LDX 86 Series — the LDX 86 Universe. A single camera that meets all your operational needs. From single-speed cutting-edge HD to ultra-clean XtremeSpeed and crisp 4K.

With the LDX 86 Series, you can purchase an HD/3G camera today and upgrade that camera to 4K when you need to, and upgrade further to include 6X HD/3G. Or you can start with a single speed HD/3G camera and upgrade your way to 6X HD/3G and upgrade further to a switchable 6X HD/3G/1X 4K camera. All with standard 1X HD outputs for simultaneous live use. Optional native HDR for single-speed operation is available via a perpetual GV-eLicense.

LDX C86^N Compact Series (Fully Native HD/3G/4K, High-Speed with optional HDR)

An extension to the LDX 86^N Series of native HD/3G/4K high-speed cameras with an identical image performance and a comparable feature set but in a smaller mechanical package. As fully self-contained cameras they offer all signal connectivity directly at the back of the camera, and does not require any additional hardware for full performance operation. They are the perfect companions to the LDX 86^N Series cameras and bring a new level of image performance and business flexibility for all applications where fully self-contained cameras with a compact form factor are required.

LDX C86 Compact Series (High Sensitive HD/3G, High-Speed with optional HDR)

The world's first self-contained high-speed cameras in a small form factor for space-constrained applications. As an extension to the LDX range of cameras, they produce the same level of quality from angles and in areas where high-speed cameras with the highest sensitivity and a compact form factor are required.

LDX 82 Series and LDX C82 Compact Series (HD/3G with optional HDR)

A unique line of advanced imaging cameras built around Xensium-FT CMOS imagers. These cameras have the highest sensitivity and image performance across different video formats, while offering a new level of business flexibility by using one hardware platform with a flexible GV-eLicense software upgrade implementation.

With the addition of BT.2020 wide color gamut support and optional native HDR support, these cameras provide an outstanding solution for all HD/3G applications.

LDX Series Advanced Imaging Camera Systems

A revolutionary series of cameras built for business flexibility and operational excellence, with superior imaging, processing and performance.

LDX 86^N/LDX 86 Series

LDX Image Acquisition Solutions: The Power of Choice

Pages 3-8

LDX 86^N Series Camera Heads

Pages 9-12

LDX 86 Series Camera Heads

Pages 13-16

XF Transmission

Pages 17-19

Camera Adapters

Page 20

LDX C86^N Compact Series Cameras

Pages 21-22

LDX C86 Compact Series Cameras

Pages 24-25

LDX 82 Series

LDX 82 Series Camera Heads

Pages 26-29

3G Transmission

Pages 30-31

Camera Adapters

Pages 32-33

LDX C82 Compact Series Cameras

Pages 34-36

Common Accessories

Camera Control Systems

Page 37

RefleX SuperXpander

Page 38

Viewfinders

Pages 39-42

LDX 82 Cameras and Accessories

Page 43

LDX 86^N/LDX 86 Cameras and Accessories

Page 44

Other

LDX Series Cameras Upgrade Paths

Page 45

Ordering Information

Page 46

Global Services

Page 47

LDX Image Acquisition Solutions: *The Power of Choice*

LDX 86^N / Native 4K Pixels When Resolution Counts

LDX 86 / Better Pixels When You Need Them

With the two complementary LDX Series of cameras (the LDX 86 Series and the LDX 86^N Series), deciding which you should purchase comes down to the old adage “the right tool for the right job.”

The LDX 86 Series is a family of five cameras with a unique upgrade path allowing daily, weekly or perpetual upgrades to higher resolution, higher frame rate or both.

The LDX 86^N Series is similar to the LDX 86 Series in camera models (World-Cam, 4K, HiSpeed, XtremeSpeed and Universe), upgradeability, features and accessories. The difference becomes apparent when you consider how 4K UHD will impact your future (if it hasn't already) and how you acquire those images.

Both the LDX 86 Series and the LDX 86^N Series acquire and output HD, 3G and high-speed images. The difference is in 4K acquisition and processing.

Two cameras in each series deliver a 4K UHD signal: the 4K and the Universe.

The LDX 86 Series of 4K cameras uses a unique closed-system process for 3840x2160 UHD where all of the processing takes place within the camera system. The benefits of acquiring 4K in this way mean high sensitivity (especially significant in low lighting situations), a global shutter similar to CCDs and the highest dynamic range available.

However, Grass Valley recognizes that native 4K has its place in the market as well, to deliver the sharpest images available. The LDX 86^N Series of five cameras is based on a new imager — a native 4K Xensium^{HAWK} CMOS imager that support full native 4K resolution as well as native HD resolution. This new 3840x2160p 4K Xensium^{HAWK} CMOS imager offers a unique pixel technology called DPM^{Ultra} (dynamic pixel management) functionality. With DPM^{Ultra}, the camera provides native 1920x1080 HD acquisition (by combining two horizontal and two vertical adjacent pixels) without the intrinsic downsides of 4K acquisition and downconversion, such as rolling shutter and decreased sensitivity, while delivering the resolution of native 4K when needed — and without having to zoom in on the image like other 4K “native” cameras are required to do to output UHD.

The LDX 86^N Series gives you the best of both HD/3G and 4K UHD worlds, along with the ability to purchase a native HD or high-speed camera today and upgrade it (on a daily, weekly or perpetual basis) to a native 4K camera.

Both the LDX 86^N Series and the LDX 86 Series offer optional HDR for single-speed operation via weekly and perpetual GV-eLicenses.

The choice is yours — you know your business best, and with either the LDX 86^N Series or the LDX 86 Series, you can be assured of getting the best images possible.

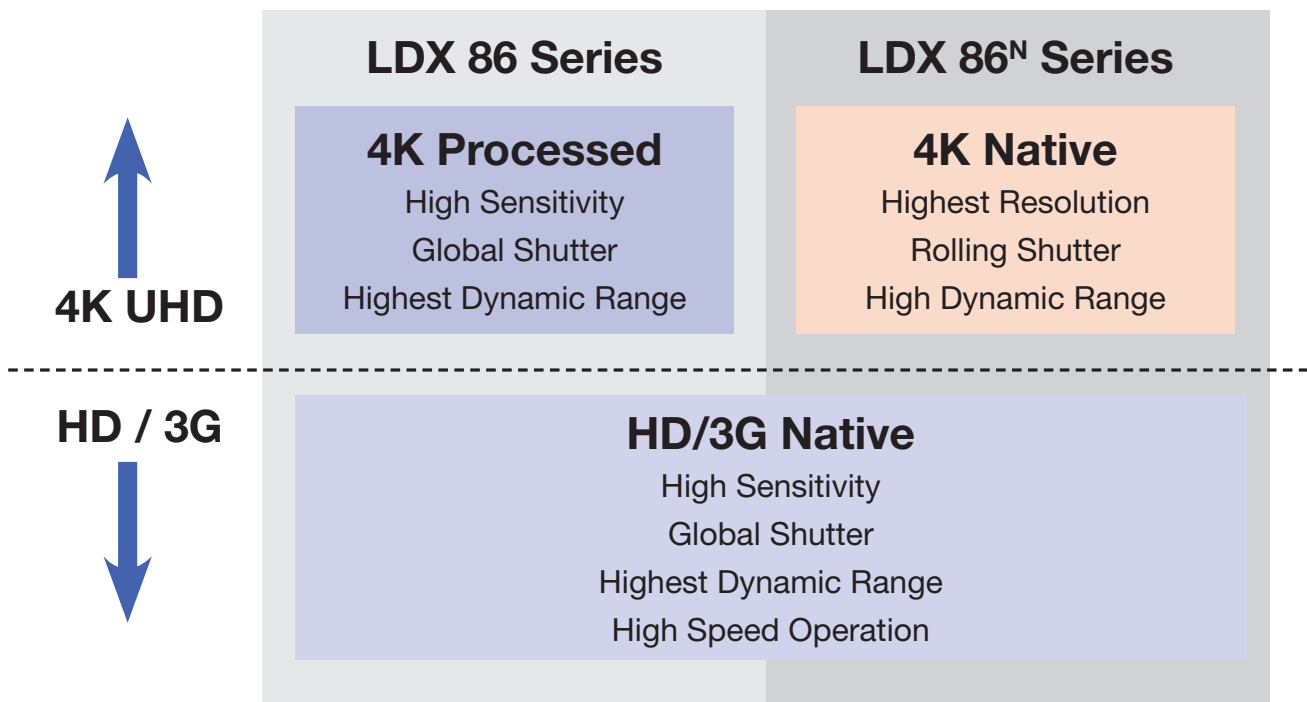

For Single-Speed Drama & Live Broadcast

Both the LDX 86^N Series and the LDX 86 Series are designed for flexibility, with the ability to be used for both dramatic productions and live broadcasts, especially sports. This is in stark contrast to other 4K camera solutions designed for dramatic productions and requiring the use of cinema-type PL mount lenses.

Only the use of compact 2/3-inch lenses with a B4 mount gives you the large zoom range, speed and depth of field which is required for demanding live and many dramatic productions. With both the LDX 86^N Series and LDX 86 Series, you can shoot HD, 3G or 4K — the same way you shoot today — without advanced technology getting in the way of storytelling.

LDX 86^N Series cameras are based on a new generation of native 3840x2160p 4K Xensium^{HAWK} CMOS imagers that support full native 4K resolution as well as native HD resolution. Each of the three 4K Xensium-HAWK CMOS imagers in the LDX 86^N Series offers a unique pixel technology called DPM^{Ultra} (dynamic pixel management) functionality. With DPM^{Ultra}, the camera provides native 1920x1080 HD acquisition (by combining two horizontal and two vertical adjacent pixels) without the intrinsic downsides of 4K acquisition, such as rolling-shutter and heavily decreased sensitivity, while delivering native 4K crispness when needed.

LDX 86 Series cameras are all built around three extremely powerful and Grass Valley-designed Xensium-FT imagers, which are the latest generation of native HD camera imagers offering all the advantages of CMOS imaging technology — high sensitivity in all video modes, high dynamic range, low power consumption and fast readout possibilities. They also include global shutter behavior which was previously only possible with CCD imagers. Xensium-FT imagers deliver unmatched sensitivity and picture quality — even in the most demanding of applications.

LDX 86^N Series and the LDX 86 Series, up to 15 F-stops of dynamic range is available from the Xensium-FT imagers in all 50/59.94 Hz formats with weekly and perpetual GV-eLicenses. This makes the LDX 86^N Series and the LDX 86 Series the first native HDR acquisition solutions available for even the most challenging live applications.

Unlike other 4K cameras, what looks like “in focus” in the viewfinder actually is “in focus” in all Grass Valley 4K cameras. As was learned in the transition from SD to HD, keeping focus in higher resolutions on a small viewfinder can be challenging for operators. Grass Valley has put significant effort to make sure that operators can focus in 4K quickly and accurately.

Your Challenges — Your Solution

Requirement	Importance			Solution				
	HD/3G	4K Close-up	4K Wide	LDX 82 Series in HD/3G	LDX 86 Series in HD/3G	LDX 86 Series in 4K	LDX 86 ^N Series in HD/3G	LDX 86 ^N Series in 4K
CMOS Imaging Technology				YES	YES	YES	YES	YES
Full Digital Imagers				YES	YES	YES	YES	YES
High Dynamic Range				YES	YES	YES	YES	YES
Global Shutter				YES	YES	YES	YES	NO
Highest Sensitivity in All Formats				YES	YES	YES	YES	NO
Native Acquisition				YES	YES	NO	YES	YES
Highest Resolution Possible				YES	YES	NO	YES	YES
				LDX 82 Series the ultimate HD/3G camera system				
				LDX 86 Series for highest sensitivity and flexibility				
				LDX 86 ^N Series when resolution counts most				

BUSINESS CASE

- The LDX 86^N Series and LDX 86 Series allows you the flexibility of purchasing the camera you need today (as CAPEX), secure in the knowledge that you can upgrade the camera (as OPEX) at any time to the formats you might need tomorrow
- LDX 86^N Series and LDX 86 Series cameras give you the flexibility to start with either a standard single-speed HD/3G camera or a 3X high-speed camera and combine their functionality in a single camera capable of switchable 1X/3X/6X HD, 1X/3X/6X 3G and 1X 4K operation with either a 1-day, 7-day term or perpetual GV-eLicense
- LDX 86^N Universe and LDX 86 Universe cameras can operate as either an HD, 3G, 4K or high-speed camera for the ultimate in camera operation
- LDX 86^N Series and LDX 86 Series cameras offer optional HDR for single-speed operation via weekly and perpetual GV-eLicenses
- LDX 86^N Universe and LDX 86 Universe cameras allow directors and producers to make any single-speed camera position a high-speed camera position with a simple menu selection (appropriate slow-motion replay control system required)
- LDX 86^N Universe and the LDX 86 Universe integrates with the K2 Dyno or LiveTouch Replay Systems, optimized for 6X super slow-motion or 4K to dramatically expand the ability to tell a compelling story during replays
- The LDX 82 Series is identical to the LDX 86 Series when used for HD/3G (but it does not support, nor is it upgrade-able to 4K UHD operation)

For High-Speed Slow-Motion Sports & Entertainment

To capture fast-paced action and emotion at unrivaled quality levels, high frame rates and with instant time-to-air, the LDX 86^N HiSpeed/LDX 86 HiSpeed (1X/3X) and the LDX 86^N XtremeSpeed/LDX 86 XtremeSpeed (1X/3X/6X) cameras give you the tools you need for engaging content that keeps viewers glued to the screen.

With LDX 86^N/LDX 86 high-speed cameras, all captured frames are output to the XCU base station instantaneously, offering an instant time-to-air replay without a cumbersome double-action memory buffer in the camera. This makes the difference between being able to bring a shot to air, or missing the moment. Since all the images can be permanently recorded, they can be used at any time and not a single moment will be missed or lost.

The LDX 86^N HiSpeed/LDX 86 HiSpeed cameras are designed for all 3X speed applications in 1.5G HD acquisition formats. However, they are the first super slow-motion camera system available which offers a double upgrade path: First to a fully featured super slow-motion camera system with up to 6X speed 3G operation. And second, to a 1X speed 4K acquisition system, with the LDX 86^N Series providing native 4K acquisition. This increase

in flexibility offers a much more future-ready solution than any other 3X or 6X speed camera system previously available.

The LDX 86^N XtremeSpeed/LDX 86 XtremeSpeed provides up to 6X speed operation, permitting the user to choose the speed which offers the best compromise between sensitivity, noise performance, additional motion resolution and the replay time needed for a wide variety of applications in live broadcast.

As the LDX 86^N and LDX 86 high-speed cameras are part of the LDX range, they integrate seamlessly and offer easy matching with all the other camera positions of the same series.

To make images look their best, LDX incorporates TrueTexture — a unique feature to preserve texture throughout all processing parameters. Another imaging innovation is ArtTouch, an intuitive interface between the operator and hardwired controls, which significantly enhances artistic possibilities within a live broadcast. Looking back at the last few years in broadcasting, a lot has changed with respect to the way productions are being managed

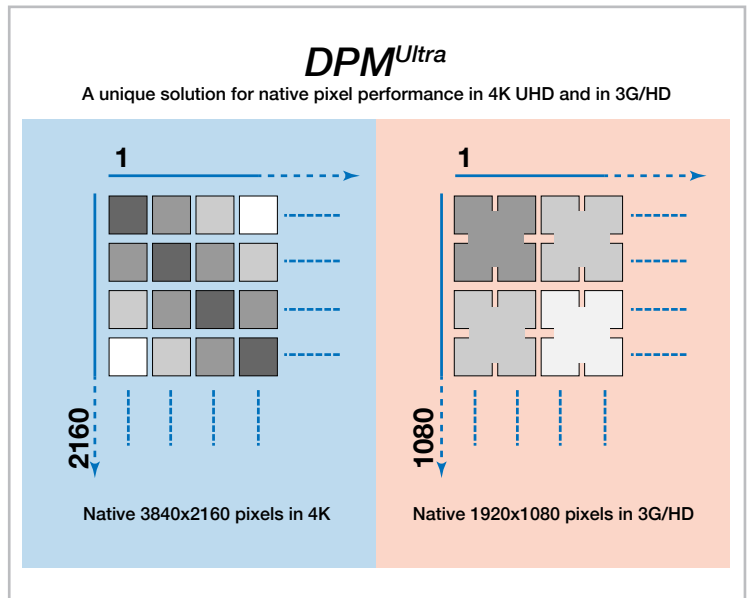
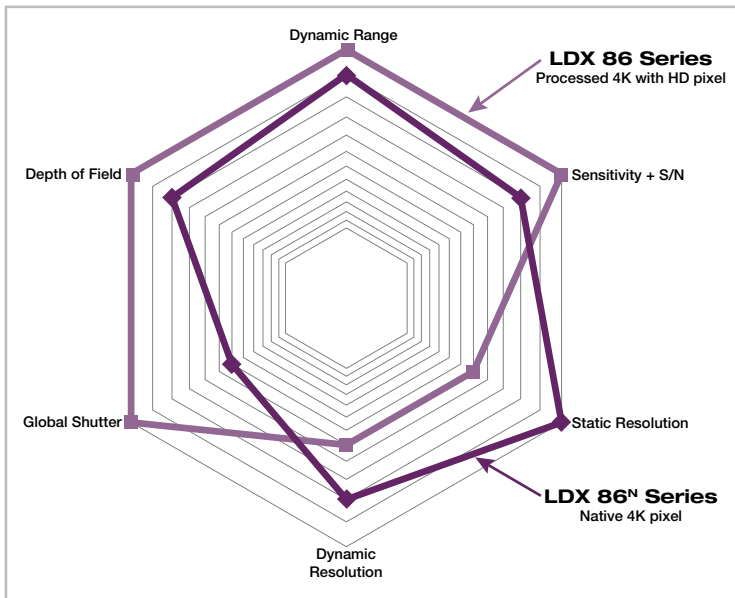

LDX 86^N UNIVERSE/LDX 86 AND LIVETOUCH & K2 DYNO UNIVERSE INTEGRATED REPLAY SYSTEM

The LDX 86^N Universe or LDX 86 Universe combined with the K2 Dyno or LiveTouch Replay System provide an integrated capture and replay system that's switchable between spatial resolution (4K) or temporal resolution (6X), while also supporting both SDI and IP connectivity.

For the ultimate in super slow-motion replay control, K2 Dyno and LiveTouch Replay Systems are available in multiple different configurations optimized for all kinds of replay applications.

With this wide range of replay systems, all 4K and all 6X workflows are now possible, with no reduction in the number of cameras and no requirement for more operators (in comparison to HD).



from an artistic point of view. To an increasing extent, there is a close collaboration between creative directors and the camera shaders, who adjust each camera feed to perfection. With all LDX cameras, a completely new level of artistic camera control is included, to support today's and tomorrow's requirements for live shading flexibility. By using the full latitude of both types of Xensium CMOS imagers, control of every aspect of the image is available, so any degree of creative touch can be applied.

All high-speed camera operations face a unique challenge caused by most artificial light sources. In stadiums, sports arenas and the like, lighting conditions are often not ideal for high-speed acquisition. A visual flicker is perceived as changes in light levels due to the mismatch between the camera scanning frequency and the power frequency of artificial lights. With the unique AnyLightXtreme feature for LDX 86^N/LDX 86 high-speed camera systems, there is compensation for this mismatch that helps to automatically reduce flicker, with several presets for different lighting conditions available in the cameras. These presets can be accessed from the operational control panel (OCP) or Creative Grading panel and app. The various presets permit the camera to reduce the flickering in the most effective way based on the lighting situation and scanning frequency.

Productions need freedom, flexibility and adaptability. Grass Valley understands the value of being able to choose the right solution to fit specific requirements. Since LDX 86^N/LDX 86 high-speed camera systems enable operation in a variety of different modes — which includes single speed (1X) operation with full performance — they can be used without any compromise in nearly all applications.

With the unique GV-eLicense program, where users have the choice of upgrading their cameras with a 1-day, 7-day or perpetual term, the LDX 86^N/LDX 86 HiSpeed can be upgraded to the LDX 86^N XtremeSpeed/LDX 86 XtremeSpeed, which offers additional flexibility. The LDX 86^N XtremeSpeed/LDX 86 XtremeSpeed can be further upgraded to the LDX 86^N Universe/LDX 86 Universe, offering “universal format” support with switchable 1X/3X/6X HD, 1X/3X/6X 3G and 1X 4K from a single camera for ultimate flexibility and equipment utilization, with native 4K acquisition in the LDX 86^N Universe.

An enhancement to the 7-day term licenses is the B.O.W.L. (bunch of weekly/daily licenses) licensing option, where users can preorder any number of 1-day or 7-day licenses and activate them whenever needed — without the need to go through an order process.

Dynamic Range

Poor lighting conditions are very likely the largest challenge to a broadcast camera in all outdoor applications because the lighting conditions are not under control.

To minimize lighting issues, we need an imager with a high dynamic range, and we also need signal processing which uses the additional dynamic range in the best way possible.

The charts below refer to the superior standard dynamic range of the Grass Valley Xensium FT CMOS imagers used in the LDX 82 and LDX 86 cameras. Additional XDR — Extended Dynamic Range — operation providing up to 15 F-stops of light exposure is available as an optional upgrade to all LDX 82, 86 and 86^N Series cameras for 50/59.94 Hz operation.

High scene contrast between sunlit and shadowy areas

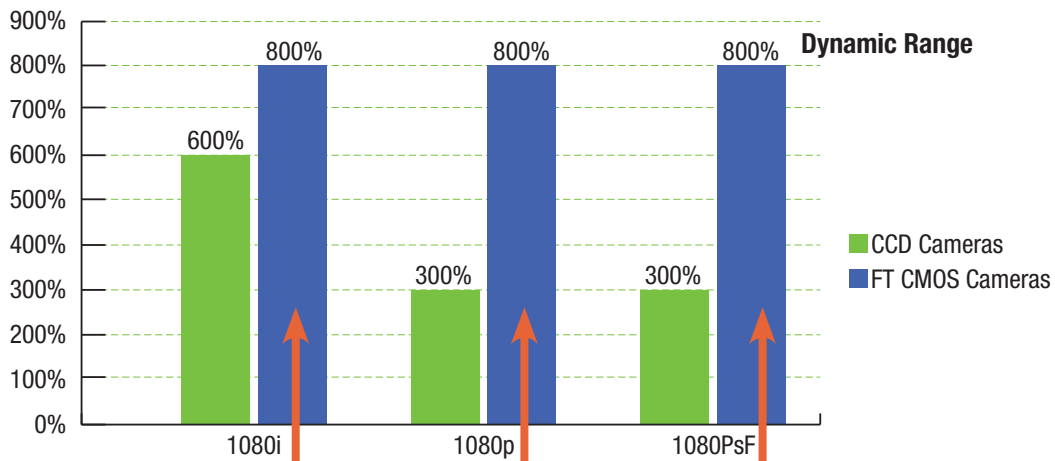

In interlace formats, CMOS imagers deliver 200% more dynamic range

In progressive formats, CMOS imagers deliver nearly 3 times the performance of CCDs

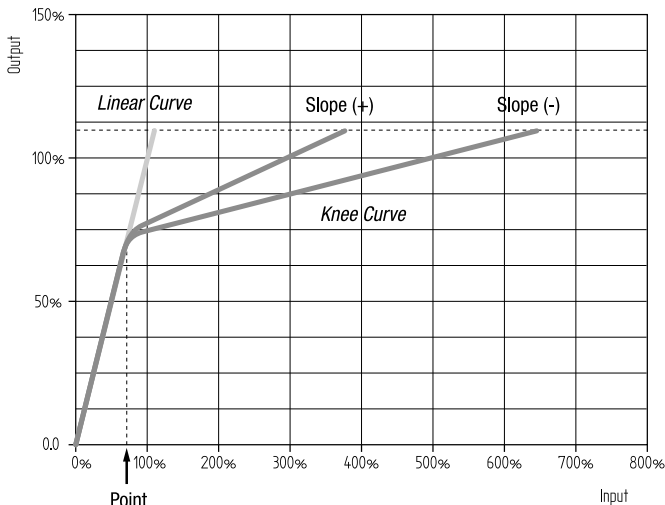

Traditional knee curve

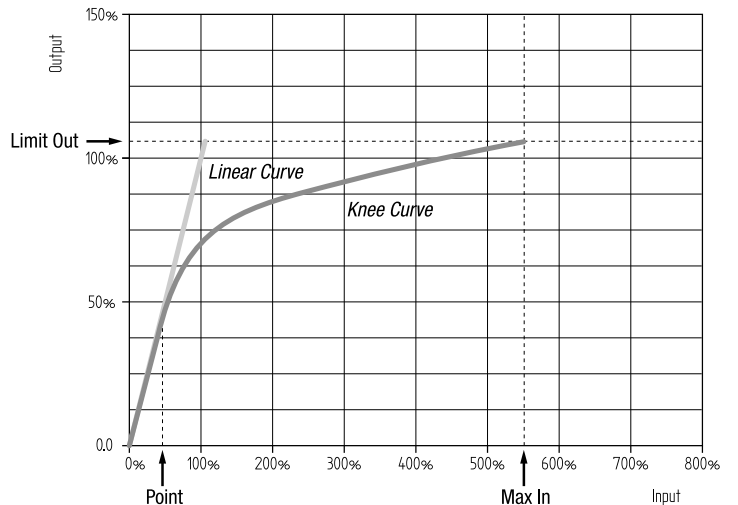

Knee power curve

The knee power curve above is for illustration purposes only. The maximum dynamic range is up to 800% for the LDX 82 Series and LDX 86 Series cameras in regular SDR (non-HDR) operation.

AnyLightXtreme

Artificial light flickering during replay is one of the largest limitations for Super Slow-Motion applications.

Most artificial light sources are “flashing” with the AC frequency

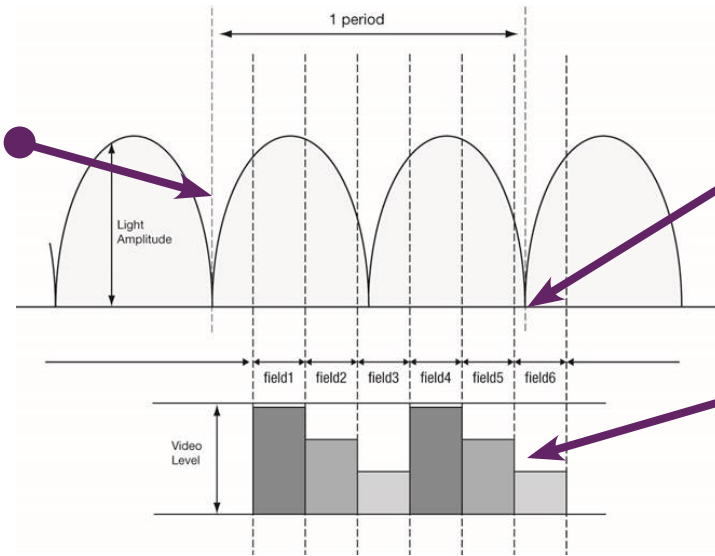

The exposure time of each high-speed frame is shorter than a light “flash”

From frame to frame the output signal varies depending on the light level

Flicker caused by artificial AC light sources.

1. AnyLightXtreme flicker reduction measures each pixel’s output signal over several frames

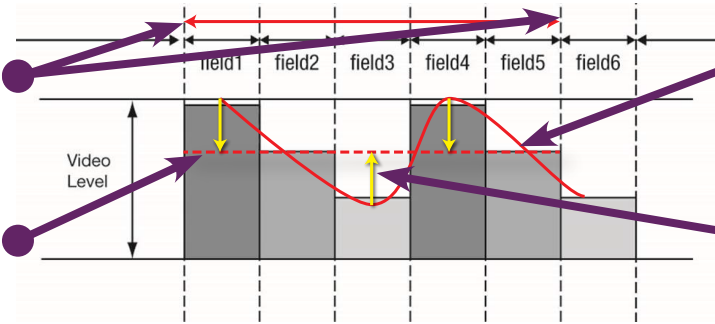

2. Any variation of the output signal will be analyzed

3. A correction signal is applied to each pixel

4. Almost any flicker can be removed from the output



All indoor sports arenas use artificial lighting. The same is true for evening events at outdoor stadiums, studio and show productions, etc.

LDX 86^N Series

Native HD/3G/4K/High-Speed HDR System Camera Solutions

Native 4K Pixels When Resolution Counts



The LDX 86^N Series cameras takes the LDX 86 Series to a new level with native 4K (3840x2160) and native HD (1920x1080) image capture, using three unique 3840x2160p 4K Xensium^{HAWK} CMOS imagers with DPM^{Ultra} (dynamic pixel management) functionality. In addition, the LDX 86^N gives you the same familiar GV-eLicense upgrade path so that you can always have the camera that you need, with the ability to use standard B4 2/3-inch HD lenses or the new B4 2/3-inch 4K lenses. So whether it's HD or 3X super slow-motion today, 3G or 6X super slow-motion tomorrow, or 4K UHD down the road, you'll be ready for whatever your productions demand.

The LDX 86^N Series of cameras from Grass Valley provides for native 4K, 3G and HD acquisition when you want the sharpest and clearest images possible, with any native single speed HD, 3G and native 4K (3840x2160p) format — as well as 3X or 6X native HD/3G speed — with the LDX 86^N Universe, a single camera that can easily switch between all these spatial and temporal formats. Plus the ability for any of the lower camera models to be upgraded in the field with GV-eLicenses — on a 1-day, 7-day or perpetual basis — to any of the higher models of the range. Optional HDR for single-speed operation is available via a weekly or perpetual GV-eLicense.

The LDX 86^N Series delivers a combination of unique multiformat native acquisition benefits not found in any other camera system:

- Parallel spatial and temporal upgrade paths:
 - LDX 86^N native HD/3G cameras are upgradable to native 4K, and/or upgradeable to high-speed native HD/3G
 - LDX 86^N high-speed cameras are upgradable from 3X native HD to 6X native HD/6X 3G, and further upgradable to 1X native 4K
- Standard B4 2/3-inch lens mounts on all LDX 86^N cameras — including 4K cameras — to accommodate HD lenses already purchased and on-hand, or 2/3-inch 4K lenses
- Three 3840x2160p4K Xensium^{HAWK} CMOS imagers with DPM^{Ultra}:
 - Native 4K UHD 3840x2160 acquisition
 - Native HD/3G 1920x1080 acquisition
 - Extended color gamut supporting the ITU-R BT.2020 standard
 - No sensitivity to fast camera movements with short exposure time in all HD/3G modes including high-speed operation modes with global shutter (similar to CCDs)
 - No sensitivity to short light flashes
 - Optional native HDR for single-speed operation

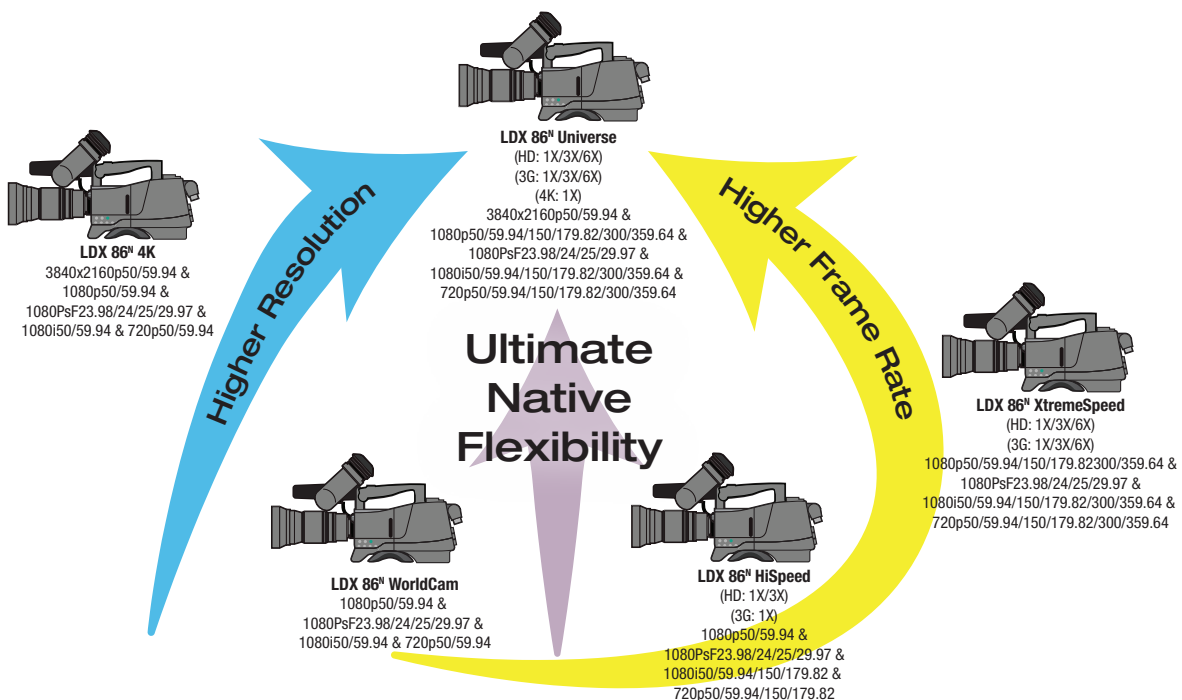

For increased flexibility, all the LDX 86^N Series camera systems use the same high performance XF Fiber transmission solutions. This allows you to mix and match all the different LDX 86^N cameras inside one production environment, including LDX 86 Series cameras. The unique and patented cradle concept of the XF Fiber XCU lets you relocate camera base stations quickly and safely, while built-in memory inside the cradle ensures that all camera/XCU settings and configurations will be automatically updated for the correct production environment.

Special processing is implemented in the LDX 86^N 4K and LDX 86^N Universe camera heads for judging the focus in 4K, which means that all current viewfinders can be used for 4K production. CLASS (chromatic lens aberration and sharpness solution) is implemented in all LDX 86^N Series cameras, and the use of CLASS/ALAC (automatic lens chromatic aberration) compatible lenses is highly recommended for 4K productions.

In addition, most of the LDX 86 Series camera accessories are identical to those used by the LDX 80 Series and the latest LDX 82 Series cameras so that a high level of interchangeability between these different product lines can be achieved.

The LDX 86^N Series

The LDX 86^N Series provide you with two parallel upgrade paths: One based on higher resolution (HD/3G/4K) and one based on higher frame rates (3X/6X). Both paths start with the LDX 86^N WorldCam as their base.

LDX 86^N Native Higher Resolution Upgrade Path

LDX 86^N WorldCam — Offers all the production formats of the LDX 82 WorldCam and LDX 86 WorldCam (HD/PsF/3G) plus an upgrade path via GV-eLicenses directly to native 4K (LDX 86^N 4K) as well as directly to 3X HD (LDX 86^N HiSpeed) or 6X HD/6X 3G (LDX 86^N XtremeSpeed), and then to all LDX 86^N formats (LDX 86^N Universe).

LDX 86^N 4K — Adds native 4K (3840x2160p) acquisition to the LDX 86^N WorldCam, and can be upgraded to 6X HD and 6X 3G high-speed (LDX 86^N Universe).

LDX 86^N Universe — Offers “universal format” support with switchable 1X/3X/6X native HD, 1X/3X/6X native 3G and 1X native 4K from a single camera for ultimate flexibility and equipment utilization.

LDX 86^N Native Higher Frame Rate Upgrade Path

LDX 86^N WorldCam — Offers all the production formats of the LDX 82 WorldCam and LDX 86 WorldCam (HD/PsF/3G) plus an upgrade path via GV-eLicenses directly to native 4K (LDX 86^N 4K) as well as directly to 3X HD (LDX 86^N HiSpeed) or 6X HD/6X 3G (LDX 86^N XtremeSpeed), and then to all LDX 86^N formats (LDX 86^N Universe).

LDX 86^N HiSpeed (HS) — Offers 1X/3X native HD acquisition for super slow-motion acquisition, as well as all the production formats of the LDX 86^N WorldCam. It can be upgraded to 1X/3X/6X HD and 1X/3X/6X 3G (LDX 86^N XtremeSpeed) as well as adding 1X native 4K (LDX 86^N Universe).

LDX 86^N XtremeSpeed (XS) — Adds 6X HD and 6X 3G acquisition to the LDX 86^N HiSpeed for super slow-motion acquisition, and can be upgraded to include 1X native 4K (LDX 86^N Universe).

LDX 86^N Universe — Offers “universal format” support with switchable 1X/3X/6X native HD, 1X/3X/6X native 3G and 1X native 4K from a single camera for ultimate flexibility and equipment utilization.

GV-eLicense PROGRAM

Perpetual license: Perpetual upgrade to the next camera in the range

7-day term license: 7-day (weekly) term upgrade to the next camera in the range

1-day term license: 1-day (24 hours) term upgrade to the next camera in the range. They are available in packs of 10 1-day licenses.

HDR weekly or perpetual license: 7-day or perpetual licenses for the addition of HDR operation in all single speed formats for all LDX 86^N Series camera heads is available. (1-day HDR licenses are not available.)

Multiple licenses may be purchased to upgrade cameras by more than one level (e.g., LDX 86^N XtremeSpeed or LDX 86^N 4K to LDX 86^N Universe). Multiple 1-day and 7-day term licenses may be purchased for extended term upgrades. The B.O.W.L. licensing system provides a way to preorder any number of 1-day or 7-day licenses and activate them whenever needed without having to place individual orders. No credit is given for the purchase of 1-day or 7-day term licenses towards the purchase of a perpetual license.

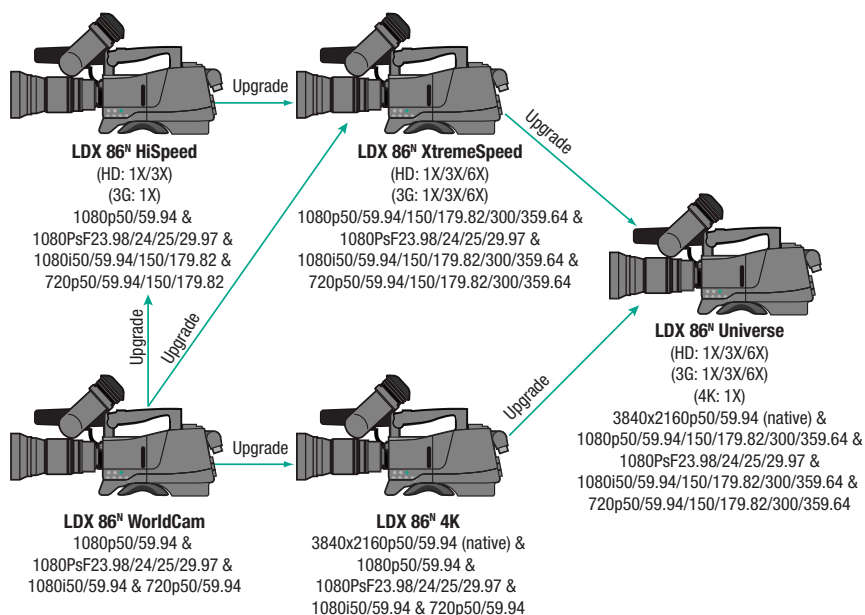

LDX 86^N SERIES KEY FEATURES (NATIVE HD/3G/4K)

- The LDX 86^N Series has the same spatial and temporal upgrade path as the LDX 86 Series, culminating in the LDX 86^N Universe for switchable 1X/3X/6X native HD, 1X/3X/6X native 3G and 1X native 4K
- The LDX 86^N WorldCam lets you buy native HD/3G acquisition today, and upgrade to native 4K and high-speed acquisition when you need to, either for 1-day (sold in packs of 10), 7-days or with a perpetual license
- The LDX 86^N 4K and LDX 86^N Universe are specifically designed for live broadcast 4K UHD in controlled lighting situations and/or wide angle camera positions, especially sports productions, where the use of traditional B4 mount HD/4K lenses instead of PL lenses enhances the producer's and director's ability to tell compelling and engaging stories, without any loss of sensitivity
- Optional HDR operation in all single speed formats
- The LDX 86^N Series now delivers wide color gamut
- LDX 86^N 4K and LDX 86^N Universe cameras are fully integrated with all the LDX 80 Series, LDX 82 Series and LDX 86 Series of cameras, so they share the same camera accessories and use the same camera control system, including full support with the C2IP for the best possible integration into external control systems
- Unique cradle connectivity to support dockable XCU (eXchangeable control unit)
- Built-in memory in XCU cradle stores settings
- Standard HD outputs for monitoring or any full performance live usage
- Extensive (analog/digital) audio connectivity
- Embedded audio
- Compact (2 RU), robust base station

LDX 86^N SERIES KEY FEATURES (HIGH-SPEED/HD/3G/4K)

- The LDX 86^N HiSpeed is the newest generation camera for 3X speed applications with improved performance. It is also the first 3X speed camera system to offer an upgrade path to a 6X super slow-motion and 4K camera system via GV-eLicenses
- The LDX 86^N XtremeSpeed 6X camera system sets a new standard for super slow-motion image acquisition by introducing a workflow with instant time-to-air without a cumbersome double-action memory buffer in the camera — so that not a single moment of the action will be missed or lost
- All high-speed cameras offer a live 1X standard-speed output in addition to the high-speed output
- All high-speed cameras offer the highest sensitivity and image performance across all of the different acquisition speeds, and the unique AnyLightXtreme flicker reduction system assure that no more irritating light flickering occurs in the replays
- The LDX 86 Series now delivers wide color gamut
- Grass Valley high-speed cameras are fully integrated with all the LDX 80 Series, LDX 82 Series and LDX 86 Series of cameras, so they share the same camera accessories and use the same camera control system, including full support with the C2IP for the best possible integration into external control systems
- Unique cradle connectivity to support dockable XCU (eXchangeable control unit)
- Built-in memory in XCU cradle stores settings
- Standard HD outputs for monitoring or any full performance live usage
- Extensive (analog/digital) audio connectivity
- Embedded audio
- Compact (2 RU) robust base station

LDX 86^N CAMERA SERIES VIDEO FORMATS

		Upgrade Path			Upgrade Path	
		LDX 86 ^N HiSpeed	LDX 86 ^N XtremeSpeed	LDX 86 ^N Universe	LDX 86 ^N 4K	LDX 86 ^N WorldCam
1X Speed HD/3G	720p50/59.94	X	X	X	X	X
	1080i50/59.94	X	X	X	X	X
	1080PsF23.98/24/25/29.97	X	X	X	X	X
	1080p50/59.94	X	X	X	X	X
High-Speed	720p150/179.82	X	X	X	—	—
	1080i150/179.82	X	X	X	—	—
	1080p150/179.82	—	X	X	—	—
	720p300/359.64	—	X	X	—	—
	1080i300/359.64	—	X	X	—	—
	1080p300/369.64	—	X	X	—	—
4K	3840x2180p50/59.94	—	—	X	X	—

LDX 86^N CAMERA SERIES COMMON SPECIFICATIONS

(Common to all LDX 86^N cameras — see below for Video Modes specifications for individual LDX 86^N camera series models)

General

Temperature range: -20° to +45°C (-4° to 113°F) (operating)
Weight: 2.1 kg (4.6 lbs.) (including handgrip and shoulder pad)
Dimensions: Width: 170 mm, depth: 200 mm, height: 180 mm (6.7 x 7.9 x 7.1 in.)
Power: Supplied through the transmission adapter

Camera

Pick-up device: 3x 2/3" 4K Xensium^{HAWK} CMOS imagers with DPM^{Ultra}
Smear: no vertical smear
Shutter: no mechanical shutter
Optical system: F1.4 prism
Lens mount: 2/3" Bayonet type
Optical filter wheels: 2x motorized wheels
Optical filters on first wheel: clear, 1/4 ND, 1/16 ND, 1/64 ND
Optical filters on second wheel: clear, 4P-star, 5µ OLPF, cap-filter
Electronic color correction: 3200°K, 5600°K, 7500°K, FL, 2 AWB presets, Var, continuous auto white

Video Modes (switchable)

S/N ratio: 60 dB typical (HD)
Aspect ratio: 16:9
Modulation depth: 60% (typical) at 800 TV lines (27 MHz) in 1080i50/59.94 & 720p50/59.94 modes
Digital resolution: Floating point A/D-conversion with 16-bit performance and with 34-bit processing in RGB
Horizontal resolution: >1,000 TV lines (HD), >2,000 TV lines (4K UHD)
Gain selection: -6 dB to +12 dB in 3 dB steps (user-definable presets) or continuous master gain
Connectivity
 Front microphone input: XLR-3 female, balanced, phantom +48V selectable
 USB
 Ethernet RJ-45
 Lens connector: Hirose 12-pin
 Viewfinder connector: 20-pin and HDMI
Control Buttons
 PickMe
 Info

Menu control
 Intercom production/engineering
 Return A / Return B
 Filter wheel selection
 Standard file recall
 4x user assignable

Control Switches

On/off
 Color bar
 Gain selection
 Color temperature
 Exposure time
 White balance

Accessories

2" LCD viewfinder
 7" LCD viewfinder (economic)
 7" LCD viewfinder (native HD)
 7.4" OLED viewfinder

LDX 86^N CAMERA SERIES VIDEO MODES SPECIFICATIONS

LDX 86^N WorldCam

1080p50/59.94, 1080PsF23.98/24/25/29.97, 1080i50/59.94 & 720p50/59.94
 Sensitivity at 2000 lux:
 – F10.0 (1080i50, 720p50 & 1080p50)
 – F9.0 (1080i59.94, 720p59.94 & 1080p59.94)
 – F14.0 (1080PsF23.98/24/25)
 – F13.0 (1080PsF29.97)

LDX 86^N 4K

3840x2160p50/59.94

Sensitivity at 2000 lux:
 – F10.0 to F5.0 (50 Hz)*
 – F9.0 to F4.5 (59.94 Hz)*

1080p50/59.94, 1080PsF23.98/24/25/29.97, 1080i50/59.94 & 720p50/59.94

Sensitivity at 2000 lux:
 – F10.0 (1080i50, 720p50 & 1080p50)
 – F9.0 (1080i59.94, 720p59.94 & 1080p59.94)
 – F14.0 (1080PsF23.98/24/25)
 – F13.0 (1080PsF29.97)

LDX 86^N HiSpeed

1080p50/59.94, 1080PsF 23.98/24/25/29.97, 1080i50/59.94/150/179.82 & 720p50/59.94/150/179.82
 Sensitivity at 2000 lux:
 – F10.0 (1080i50, 720p50 & 1080p50)
 – F9.0 (1080i59.94, 720p59.94 & 1080p59.94)
 – F6.0 (1080i150 & 720p150)
 – F5.2 (1080i179.82 & 720p179.82)
 – F14.0 (1080PsF23.98/24/25)
 – F13.0 (1080PsF29.97)

LDX 86^N XtremeSpeed

1080p50/59.94/150/179.82/300/359.64, 1080PsF 23.98/24/ 25/29.97, 1080i50/59.94/150/179.82/300/359.64 & 720p50/59.94/150/179.82/300/359.64
 Sensitivity at 2000 lux:
 – F10.0 (1080i50, 720p50 & 1080p50)
 – F9.0 (1080i59.94, 720p59.94 & 1080p59.94)
 – F6.0 (1080i150, 720p150 & 1080p150)
 – F5.2 (1080i179.82, 720p179.82 & 1080p179.82)
 – F4.3 (1080i300, 1080p300 & 720p300)
 – F3.7 (1080i359.64, 1080p359.64 & 720p359.64)
 – F14.0 (1080PsF 23.98/24/25)
 – F13.0 (1080PsF29.97)

LDX 86^N Universe

3840x2160p50/59.94

Sensitivity at 2000 lux:
 – F10.0 to F5.0 (50 Hz)*
 – F9.0 to F4.5 (59.94 Hz)*

1080p50/59.94/150/179.82/300/359.64, 1080PsF23.98/24/25/29.97, 1080i50/59.94/150/179.82/300/359.64 & 720p50/59.94/150/179.82/300/359.64

Sensitivity at 2000 lux:
 – F10.0 (1080i50, 720p50 & 1080p50)
 – F9.0 (1080i59.94, 720p59.94 & 1080p59.94)
 – F6.0 (1080i150, 720p150 & 1080p150)
 – F5.2 (1080i179.82, 720p179.82 & 1080p179.82)
 – F4.3 (1080i300, 1080p300 & 720p300)
 – F3.7 (1080i359.64, 1080p359.64 & 720p359.64)
 – F14.0 (1080PsF23.98/24/25)
 – F13.0 (1080PsF29.97)

* Specifications depend on the selected sensitivity mode.
 Notes: All figures are valid for operation in native acquisition modes.

LDX 86 Series

HD/3G/4K/High-Speed/HDR System Camera Solutions

Better Pixels When You Need Them for the Highest Light Sensitivity

With the LDX 86 Series cameras, you no longer need to choose between a higher frame rate like 6X, or higher resolution for 4K — you can have both in a single camera: the LDX 86 Universe. You can even upgrade to LDX 86 Universe features from other LDX 86 Series cameras when you need to. This advanced multiformat (HD/3G/4K) and multispeed (1X/3X/6X) content acquisition system is combined with outstanding image performance, excellent light sensitivity and the ability to use standard HD lenses. This allows broadcasters and content creators to use the same workflows they use for HD, while delivering the best HD/3G high-speed slow-motion or 4K viewing experience possible. XDR — Extended Dynamic Range — operation (native HDR with full 15 F-stops or >800% of regular cameras) is available for all 50/59.94 Hz formats offering a new level of viewer experience.

Broadcast production is constantly changing: HD, 3G and 4K, with or without HDR, are all variations in today's world of production. One of the main challenges in broadcast production is to be flexible enough to handle whatever formats might be required. And knowing that these requirements might change over time, as well.

The LDX 86 Series of cameras from Grass Valley offer the perfect solution for all these requirements, with any single speed HD, 3G and 4K (3840x2160p) format with or without HDR — as well as 3x and 6x HD/3G speed — and even a single camera that can easily switch between all these spatial and temporal formats. Plus the ability for any of the lower camera models to be upgraded in the field with GV-eLicenses — on a 1-day, 7-day or perpetual basis — to any of the higher models of the range.



The LDX 86 Series delivers a combination of unique benefits:

- Parallel spatial and temporal upgrade paths:
 - LDX 86 HD/3G cameras are upgradable to 4K, and/or upgradeable to high-speed HD/3G
 - LDX 86 high-speed cameras are upgradable from 3X HD to 6X HD/6X 3G, and further upgradable to 1X 4K
- Standard B4 2/3-inch lens mounts on all LDX 86 cameras — including 4K cameras — to accommodate HD lenses already purchased and on-hand
- High sensitivity in all formats and speeds:
 - Provides for a larger f-stop (smaller iris)
 - Less lighting required for high-speed and 4K acquisition than other camera systems
 - Increased depth of field aiding in ability to hold tight focus
- Upgrade path for true 15 F-stop native HDR operation in all 50/59.94 Hz formats (HD/3G/4K)
- Three Xensium-FT CMOS imagers with global shutter — similar to CCD sensors:
 - Now with extended color gamut supporting the ITU-R BT.2020 standard
 - No sensitivity to fast camera movements with short exposure time
 - No sensitivity to short light flashes

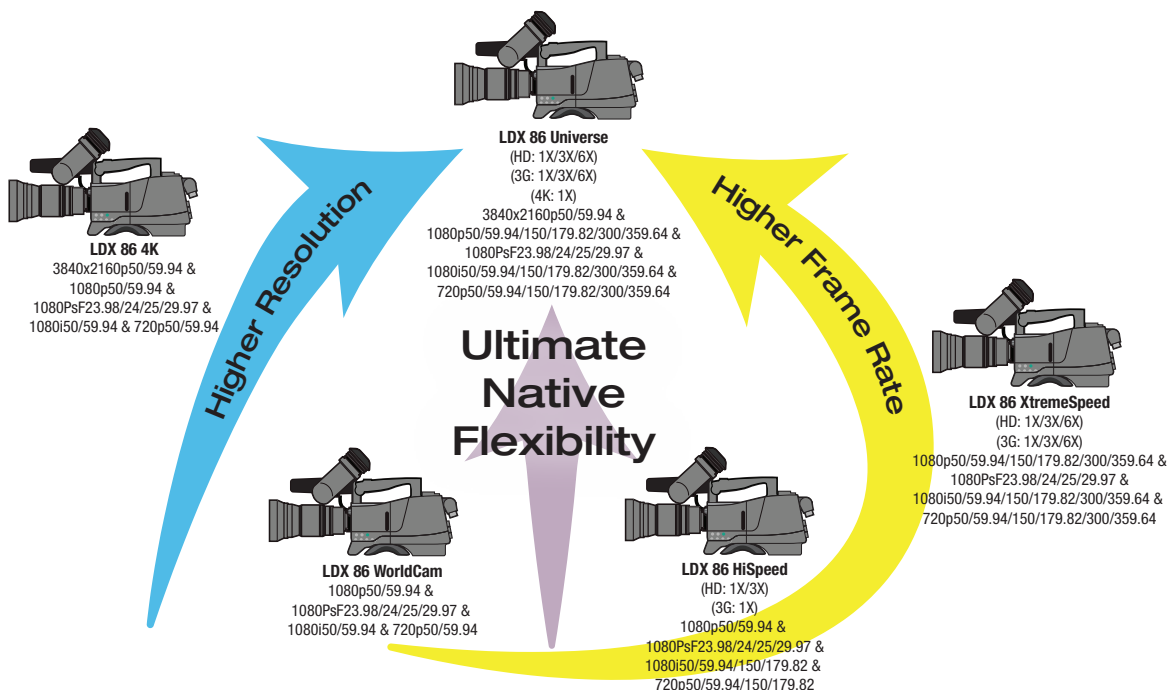

For increased flexibility, all LDX 86 Series as well as LDX 86^N Series camera systems use the same high performance XF Fiber transmission solutions. This allows you to mix and match all the different LDX 86 cameras inside one production environment. The unique and patented cradle concept of the XF Fiber XCU lets you relocate camera base stations quickly and safely, while built-in memory inside the cradle ensures that all camera/XCU settings and configurations will be automatically updated for the correct production environment.

Special processing is implemented in the LDX 86 4K and LDX 86 Universe camera heads for judging the focus in 4K, which means that all current viewfinders can be used for 4K production. CLASS (chromatic lens aberration and sharpness solution) is implemented in all LDX 86 Series cameras, and the use of CLASS/ALAC (automatic lens chromatic aberration) compatible lenses is highly recommended for 4K productions.

In addition, most of the LDX 86 Series camera accessories are identical to those used by the latest LDX 82 Series cameras so that a high level of interchangeability between these different product lines can be achieved.

The LDX 86 Series

The LDX 86 Series provide you with two parallel upgrade paths: One based on higher resolution (HD/3G/4K) and one based on higher frame rates (3X/6X).

LDX 86 Higher Resolution Upgrade Path

LDX 86 WorldCam — Offers all the production formats of the LDX 82 WorldCam (HD/PsF/3G) plus an upgrade path via GV-eLicenses directly to 4K (LDX 86 4K) as well as directly to 3X HD (LDX 86 HiSpeed) or 6X HD/6X 3G (LDX 86 XtremeSpeed), and then to all LDX 86 formats (LDX 86 Universe).

LDX 86 4K — Adds 4K (3840x2160p) acquisition to the LDX 86 WorldCam, and can be upgraded to 1X/3X/6X HD and 1X/3X/6X 3G high-speed (LDX 86 Universe).

LDX 86 Universe — Offers “universal format” support with switchable 1X/3X/6X HD, 1X/3X/6X 3G and 1X 4K from a single camera for ultimate flexibility and equipment utilization.

LDX 86 Higher Frame Rate Upgrade Path

LDX 86 WorldCam — Offers all the production formats of the LDX 82 WorldCam (HD/PsF/3G) plus an upgrade path via GV-eLicenses directly to 4K (LDX 86 4K) as well as directly to 3X HD (LDX 86 HiSpeed) or 6X HD/6X 3G (LDX 86 XtremeSpeed), and then to all LDX 86 formats (LDX 86 Universe).

LDX 86 HiSpeed (HS) — Offers 1X/3X HD acquisition for super slow-motion acquisition, as well as all the production formats of the LDX 86 WorldCam. It can be upgraded to 1X/3X/6X HD and 1X/3X/6X 3G (LDX 86 XtremeSpeed) as well as adding 1X 4K (LDX 86 Universe).

LDX 86 XtremeSpeed (XS) — Adds 6X HD and 6X 3G acquisition to the LDX 86 HiSpeed for super slow-motion acquisition, and can be upgraded to include 1X 4K (LDX 86 Universe).

LDX 86 Universe — Offers “universal format” support with switchable 1X/3X/6X HD, 1X/3X/6X 3G and 1X 4K from a single camera for ultimate flexibility and equipment utilization.

The LDX 86 Series of cameras offer the perfect solution for all format requirements, especially when light sensitivity is of prime importance. Acquiring in native 1920x1080, the LDX 86 4K and LDX 86 Universe cameras use a unique closed-system process for 3840x2160 UHD where all of the processing takes place within the camera system. This delivers a 4K image with the highest light sensitivity available in any system camera, with images in many applications almost indistinguishable from native 4K acquisition.

GV-eLicense PROGRAM

Perpetual license: Perpetual upgrade to the next camera in the range

7-day term license: 7-day (weekly) term upgrade to the next camera in the range

1-day term license: 1-day (24 hours) term upgrade to the next camera in the range. They are available in packs of 10 1-day licenses.

HDR weekly or perpetual license: 7-day or perpetual licenses for the addition of true 15 F-stop HDR operation in all single speed formats for all LDX 86 Series camera heads is available. (1-day HDR licenses are not available.)

Multiple licenses may be purchased to upgrade cameras by more than one level (e.g., LDX 86 XtremeSpeed or LDX 86 4K to LDX 86 Universe). Multiple 1-day and 7-day term licenses may be purchased for extended term upgrades. The B.O.W.L. licensing system provides a way to preorder any number of 1-day or 7-day licenses and activate them whenever needed without having to place individual orders. No credit is given for the purchase of 1-day or 7-day term licenses towards the purchase of a perpetual license.

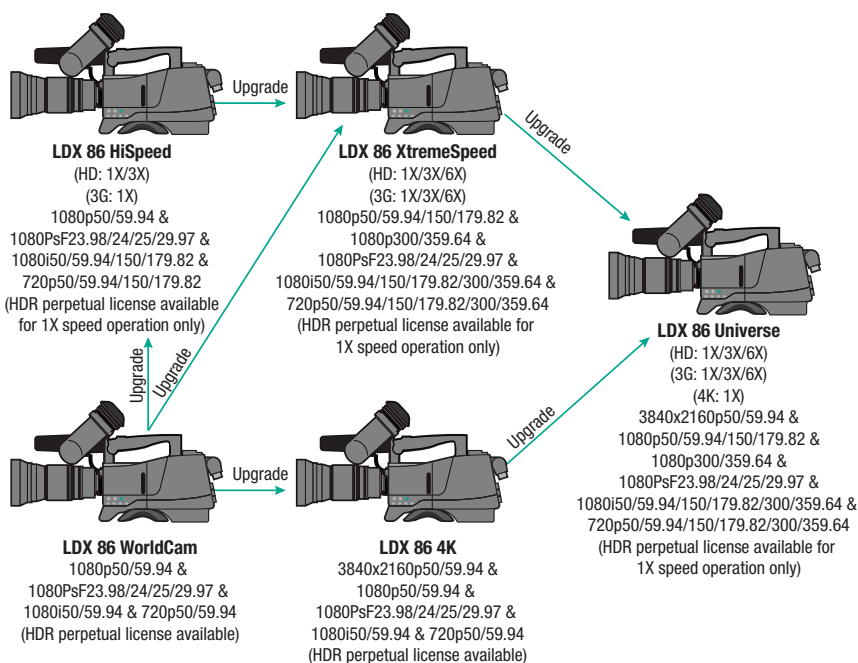

LDX 86 SERIES KEY FEATURES (HD/3G/4K)

- The LDX 86 Series is the first camera family to have both a spatial and temporal upgrade path, culminating in the LDX 86 Universe for switchable 1X/3X/6X HD, 1X/3X/6X 3G and 1X 4K
- The LDX 86 WorldCam lets you buy HD/3G acquisition today, and upgrade to 4K and high-speed acquisition when you need to, either for 1-day (sold in packs of 10), 7-days or with a perpetual license
- The LDX 86 4K and LDX 86 Universe are specifically designed for live broadcast UHD/4K, especially sports productions, where the use of traditional B4 mount HD lenses instead of PL lenses enhances the producer’s and director’s ability to tell compelling and engaging stories, without any loss of sensitivity
- The LDX 86 4K and LDX 86 Universe camera systems offers the highest sensitivity and dynamic range performance of all currently available 4K cameras
- The LDX 86 Series cameras are the first cameras offering an upgrade to true 15 F-stop HDR operation for live applications
- The LDX 86 Series now delivers wide color gamut supporting the ITU-R BT.2020 standard
- The full power of 15 F-stops of dynamic range is available from the Xensium-FT imagers in all single speed formats with a 7-days or with a perpetual HDR GV-eLicense. This makes the LDX 86 Series the first HDR acquisition solution available for even the most challenging live applications
- LDX 86 4K and LDX 86 Universe cameras are fully integrated with all the LDX 80 Series, LDX 82 Series and LDX 86 Series of cameras, so they share the same camera accessories and use the same camera control system, including full support with the C2IP for the best possible integration into external control systems
- Unique cradle connectivity to support dockable XCU (eXchangeable control unit)
- Built-in memory in XCU cradle stores settings
- Standard HD outputs for monitoring or any full performance live usage
- Extensive (analog/digital) audio connectivity
- Embedded audio
- Compact (2 RU), robust base station

LDX 86 SERIES KEY FEATURES (HIGH-SPEED/HD/3G/4K)

- The LDX 86 HiSpeed delivers 3X speed applications. It is also the first 3X speed camera system to offer an upgrade path to a 6X super slow-motion and 4K camera system via GV-eLicenses
- The LDX 86 XtremeSpeed 6X camera system sets a new standard for super slow-motion image acquisition by introducing a workflow with instant time-to-air without a cumbersome double-action memory buffer in the camera — so that not a single moment of the action will be missed or lost
- All high-speed cameras offer a live 1X standard-speed output in addition to the high-speed output
- All high-speed cameras offer the highest sensitivity and image performance across all of the different acquisition speeds, and the unique AnyLightXtreme flicker reduction system assure that no more irritating light flickering occurs in the replays
- The LDX 86 Series now delivers an extended color gamut supporting the ITU-R BT.2020 standard
- Grass Valley high-speed cameras are fully integrated with all the LDX 80 Series, LDX 82 Series and LDX 86 Series of cameras, so they share the same camera accessories and use the same camera control system, including full support with the C2IP for the best possible integration into external control systems
- Unique cradle connectivity to support dockable XCU (eXchangeable control unit)
- Built-in memory in XCU cradle stores settings
- Standard HD outputs for monitoring or any full performance live usage
- Extensive (analog/digital) audio connectivity
- Embedded audio
- Compact (2 RU) robust base station

LDX 86 CAMERA SERIES VIDEO FORMATS

		Upgrade Path			Upgrade Path	
		LDX 86 HiSpeed	LDX 86 XtremeSpeed	LDX 86 Universe	LDX 86 4K	LDX 86 WorldCam
1X Speed HD/3G	720p50/59.94	X	X	X	X	X
	1080i50/59.94	X	X	X	X	X
	1080PsF23.98/24/25/29.97	X	X	X	X	X
	1080p50/59.94	X	X	X	X	X
High-Speed	720p150/179.82	X	X	X	—	—
	1080i150/179.82	X	X	X	—	—
	1080p150/179.82	—	X	X	—	—
	720p300/359.64	—	X	X	—	—
	1080i300/359.64	—	X	X	—	—
	1080p300/369.64	—	X	X	—	—
4K	3840x2180p50/59.94	—	—	X	X	—

LDX 86 CAMERA SERIES COMMON SPECIFICATIONS

(Common to all LDX 86 cameras — see below for Video Modes specifications for individual LDX 86 camera series models)

General

Temperature range: -20° to +45°C (-4° to 113°F) (operating)
Weight: 2.1 kg (4.6 lbs.) (including handgrip and shoulder pad)
Dimensions: width: 170 mm, depth: 200 mm, height: 180 mm (6.7 x 7.9 x 7.1 in.)
Power: Supplied through the transmission adapter

Camera

Pick-up device: 3x 2/3" Xensium-FT CMOS
Smear: no vertical smear
Shutter: no mechanical shutter
Optical system: F1.4 prism
Lens mount: 2/3" Bayonet type
Optical filter wheels: 2x motorized wheels
Optical filters on first wheel: clear, 1/4 ND, 1/16 ND, 1/64 ND
Optical filters on second wheel: clear, 4P-star, soft focus
Electronic color correction: 3200°K, 5600°K, 7500°K, FL, 2 AWB presets, Var, continuous auto white
Exposure: electronic exposure down to 1/1000 sec (depending on video mode)

Video Modes (switchable)

S/N ratio: 62 dB typical
Aspect ratio: 16:9
Modulation depth: 60% (typical) at 800 TV lines (27 MHz) in 1080i50/59.94 & 720p50/59.94 modes
Digital resolution: Floating point A/D-conversion with 16-bit performance and with 34-bit processing in RGB
Horizontal resolution: >1,000 TV lines
Gain selection: -6 dB to +18 dB in 3 dB steps (user-definable presets) or continuous master gain

Connectivity

Front microphone input: XLR-3 female, balanced, phantom +48V selectable
 USB
 Ethernet RJ-45
 Lens connector: Hirose 12-pin
 Viewfinder connector: 20-pin and HDMI

Control Buttons

PickMe
 Info
 Menu control
 Return A / Return B
 Intercom production/engineering
 Filter wheel selection
 Standard file recall
 4x user assignable

Control Switches

On/off
 Color bar
 Gain selection
 Color temperature
 Exposure time
 White balance

Accessories

2" LCD viewfinder
 7" LCD viewfinder (economic)
 7" LCD viewfinder (native HD)
 7.4" OLED viewfinder

LDX 86 CAMERA SERIES VIDEO MODES SPECIFICATIONS

LDX 86 WorldCam

1080p50/59.94, 1080PsF23.98/24/25/29.97, 1080i50/59.94 & 720p50/59.94

Sensitivity at 2000 lux:
 - F12.0 (1080i50, 720p50 & 1080p50)
 - F11.0 (1080i59.94, 720p59.94 & 1080p59.94)
 - F18.0 (1080PsF23.98/24/25)
 - F16.0 (1080PsF29.97)

LDX 86 4K

3840x2160p50/59.94

Sensitivity at 2000 lux:
 - F12.0 (50 Hz)
 - F11.0 (59.94 Hz)

1080p50/59.94, 1080PsF23.98/24/25/29.97, 1080i50/59.94, 720p50/59.94

Sensitivity at 2000 lux:
 - F12.0 (1080i50, 720p50 & 1080p50)
 - F11.0 (1080i59.94, 720p59.94 & 1080p59.94)
 - F18.0 (1080PsF23.98/24/25)
 - F16.0 (1080PsF29.97)

LDX 86 HiSpeed

1080p50/59.94, 1080PsF25/29.97, 1080i50/59.94/150/179.82 & 720p50/59.94/150/179.82

Sensitivity at 2000 lux:
 - F12.0 (1080i50, 720p50 & 1080p50)
 - F11.0 (1080i59.94, 720p59.94 & 1080p59.94)
 - F6.9 (1080i150 & 720p150)
 - F6.3 (1080i179.82 & 720p179.82)

LDX 86 XtremeSpeed

1080p50/59.94/150/179.82/300/359.64, 1080PsF25/29.97, 1080i50/59.94/150/179.82/300/359.64 & 720p50/59.94/150/179.82/300/359.64

Sensitivity at 2000 lux:
 - F12.0 (1080i50, 720p50 & 1080p50)
 - F11.0 (1080i59.94, 720p59.94 & 1080p59.94)
 - F6.9 (1080i150, 720p150 & 1080p150)
 - F6.3 (1080i179.82, 720p179.82 & 1080p179.82)
 - F4.9 (1080i300, 1080p300 & 720p300)
 - F4.5 (1080i359.64, 1080p359.64 & 720p359.64)
 - F18.0 (1080PsF25)
 - F16.0 (1080PsF29.97)

LDX 86 Universe

3840x2160p50/59.94

Sensitivity at 2000 lux:
 - F12.0 (50 Hz)
 - F11.0 (59.94 Hz)

1080p50/59.94/150/179.82/300/359.64, 1080PsF23.98/24/25/29.97, 1080i50/59.94/150/179.82/300/359.64 & 720p50/59.94/150/179.82/300/359.64

Sensitivity at 2000 lux:
 - F12.0 (1080i50, 720p50 & 1080p50)
 - F11.0 (1080i59.94, 720p59.94 & 1080p59.94)
 - F6.9 (1080i150, 720p150 & 1080p150)
 - F6.3 (1080i179.82, 720p179.82 & 1080p179.82)
 - F4.9 (1080i300, 1080p300 & 720p300)
 - F4.5 (1080i359.64, 1080p359.64 & 720p359.64)
 - F18.0 (1080PsF23.98/24/25)
 - F16.0 (1080PsF29.97)

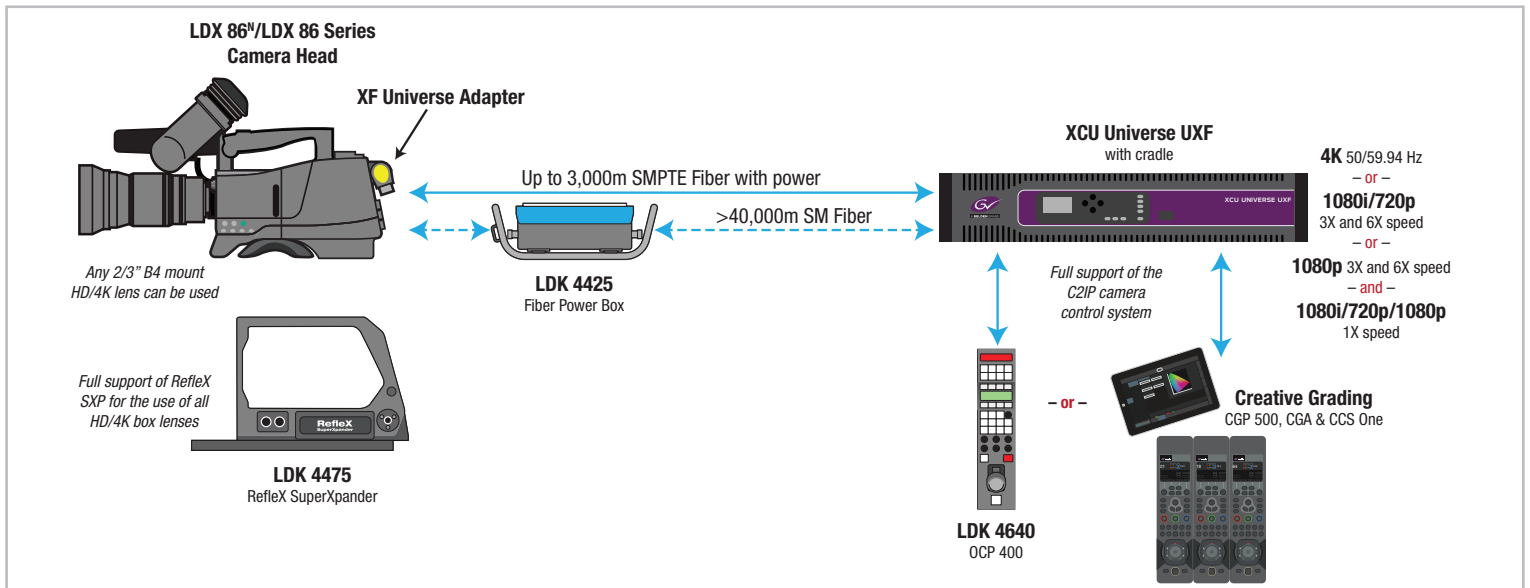

XF Transmission

XF Transmission consists of the XCU UXF/XF Fiber base stations and the LDX XF Universe camera adapter, offering a future-ready transmission system which supports the large bandwidth required by LDX 86 and LDX 86^N high-speed and 4K-capable cameras without any compromises, with full SDI and IP connectivity using BNC and SFP+ compatible modules. The rack-mounted UXF cradle is fully compatible with the 3G transmission XCUs, which makes all UXF, XF and 3G XCU chassis easily removable, and permits converting any normal speed camera position into a high-speed camera position in just minutes.

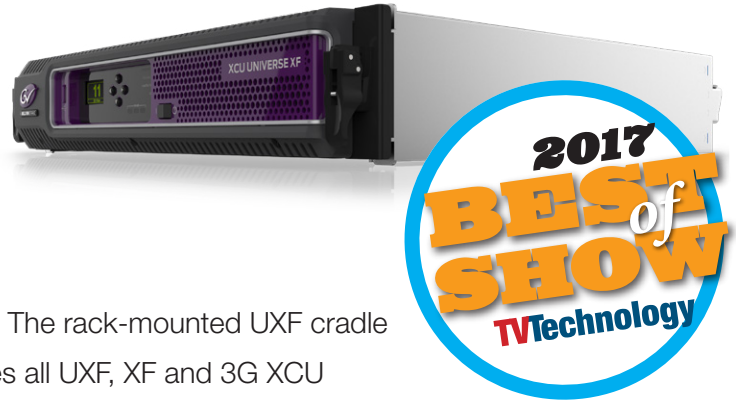

Grass Valley XCU XF Fiber base stations have been developed to support the extended bandwidth requirements of LDX 86 and LDX 86^N high-speed cameras with up to 6X speed operation, and 4K-capable cameras. They are the latest members of the XCU range of camera base stations and share the same unique cradle concept with the other XCUs that are available for the LDX 82 Series and LDX 80 Series of cameras. The future-ready UXF cradle offer a further improved IP connectivity and supports the broadcast requirements of today and tomorrow.

The XF transmission systems are heavy-duty, high-quality, multistandard systems with specially developed advanced technologies. XF transmission systems are fully 3G, 3D and 4K ready, and supports current 1080i50/59.94 and 720p50/59.94 formats in up to 6X speeds, 1080p50/59.94 transmission in up to 6X speeds, as well as single-speed 1080PsF23.98/24/25/29.97, with 3840x2160p50/59.94 for 4K UHD applications.

In addition to the full baseband connectivity supported by the XCU Universe XF, both versions of the XCU UXF support 4x SFP+ connections. These can be equipped with 10 GbE SFPs for redundant IP connections or with dedicated SFPs offering 12G SDI outputs. The IP connections are selectable, supporting SMPTE ST 2022-6 as well as SMPTE ST 2110.

The XF transmission systems works perfectly with SMPTE hybrid fiber cables, offers an increased maximum cable length, and has the capability to support even the extended bandwidth requirements of high-speed camera systems. The maximum cable length (including power) can be up to 3,000m (9,842 feet), and when powering the camera locally, a maximum cable length of more than 40,000m (24.85 miles) can be achieved.

The unique patented UXF cradle implementation of the XCU base stations takes flexibility to a new level in connectivity. The UXF cradle (XCUs each come with one cradle — additional cradles are available separately) can be pre-mounted and pre-wired in the rack so that the XCU base stations can easily slide in and out whenever needed, making a secure mechanical and electrical connection.

Unique benefits are:

- Significant time saving while reconfiguring OB trucks
- Preventing cabling or configuration mistakes
- Reducing vehicle or facility costs
- Takes minimal rack space: a compact design of only 2 RU

The combination of all of these features delivers flexibility between OB trucks, and cuts the shipping/transport costs of moving XCUs between locations. XCU base stations offer extended connectivity. The XCU XF Fiber base stations are equipped with two 4K UHD outputs or six 3G/HD outputs (depending on camera output), and two additional HD outputs. These standard HD outputs automatically convert the signal to 1080i or 720p when the camera head is delivering 1080p, 1080PsF or 4K. In addition, three HD return connections are provided, two of which can be selected as a viewfinder return signal by the camera operator and one is available as a permanent video output on the camera adapter. Audio connectivity offers great versatility with two analog outputs and two AES/EBU pair outputs (2x2 channels) which are also embedded in the HD-SDI outputs.

XF Transmission Direct IP Interface eLicense

With high bandwidth IP networks becoming more and more available for live productions, this new eLicense enables a direct IP interface of the complete transmission protocol between the cameras and XCUs over IP networks. The Grass Valley LDX series of cameras are the only cameras available with a direct IP interface from the camera itself.

As the direct IP interface is fully transparent, there are no limitations in the performance or features supported by the camera systems, making this an ideal solution for the most demanding remote camera applications.

With the introduction of this new feature for LDX cameras using the XF Fiber transmission systems, you can now have full live IP remote productions. By connecting the cameras and the XCUs through COTS switches with 10 GbE ports to a high bandwidth IP network, any camera can be assigned to any XCU via the GV Connect Gateway.

In this way, one central command/control center can be used to manage several different production facilities. When a production is finished, the cameras and the XCUs can easily be re-routed for the next production.

This can result in a savings in production costs (with control room staff not having to be on location) while maintaining high quality production.

SMPT E hybrid fiber connection for cameras 4x SFP+ connections (optional 12G SDI SFPs can be used in addition to the IP SFPs) All the traditional baseband connectivity from regular XCUs while transitioning to IP



	XCU Universe XF	XCU Enterprise UXF	XCU Universe UXF
Full baseband connectivity	✓	✓	✓
Full IP connectivity	✗	✓	✓
12G SDI support (optional)	✗	✓	✓
HD/3G/4K UHD support in single speed	✓	✓	✓
High-speed support	3x HD, 6x HD, 3x 3G	✗	✓
	6x 3G	✗	✓
Direct IP support	✓	✓	✓
HDR support	In single speed	✓	✓
	In high speed	✗	✓
Simultaneous outputs in: 4K HDR, 3G/HD HDR, 3G/HD SDR	✗	✓	✓
LDX 100 support	✗	✗	✓
Delivered with cradle	✓	✗	✗
Delivered with UXF cradle with 4x SFP+ slots	✗	✓	✓

XF TRANSMISSION KEY FEATURES

- Unique UXF cradle connectivity to support dockable XCUs
- Built-in memory in XCU cradle for production-set storage
- Universe XF transmission supports the high bandwidth required by high-speed and 4K cameras
- Full support for all speeds and HD formats:
 - 1X to 6X speed (dependent on camera and format)
 - 720p/1080i/1080p/1080PsF/3840x2160p (4K)
- Video outputs:
 - 2x 4K* and 2x 1.5G or 3G video outputs (in 4K mode)
 - 6x 3G* and 2x 1.5G or 8x 1.5G* video outputs (in 1X speed)
 - 2x three phases on 6x 1.5G and 2x 1.5G live (in 3X speed 720p, 1080i)
 - 2x three phases on 6x 3G and 2x 3G live (in 6X speed 1080p)
 - 2x six phases on 6x 3G (dual-link) and 2x 1.5G live (in 6X speed 720p, 1080i, 1080p)

- Extensive (analog/digital) audio connectivity
- Embedded audio
- 3x selectable return inputs:
 - 3G, HD, or SD
- 1 Gbit IP trunk
- Universal 3G power supply
- Compact (2 RU), robust base station

XCUs with 4x SFP+ connections

- Optional SFPs available for:
 - Redundant 10 GbE IP connections
 - 12G SDI outputs
- IP connections:
 - SMPTE ST 2022-6 compliant
 - SMPTE ST 2110 compliant
 - Support high speed operation

* During HDR operation, some of the signals will be with SDR mapping and some of the signals will be with HDR mapping

XF TRANSMISSION SPECIFICATIONS

Video (specific format support depends on the camera model)

720p: 50/59.94/150/179.82/300/359.64 Hz

1080i: 50/59.94/150/179.82/300/359.64 Hz

1080p: 50/59.94/150/179.82 Hz

4K UHD: 3840x2160p50/59.94

Compatible Cameras

LDX 80 Series, LDX 82 Series, LDX 86 Series and LDX 86th Series

General (incl. cradle)

Dimensions XCU + cradle (HxWxL, approx.): 448 x 86.5 x 533 mm (19" rack, 2 RU) (17.6 x 3.4 x 21.0 in.)

Operating temperature: 0 to +45°C (+32 to +113°F)

Storage temperature: -20 to +70°C (-4 to +158°F)

Operation humidity: Max. 90% (noncondensing)

Shock resistance: Max. 10G (transport), max. 2G (operating)

Altitude: Max. 15,420m (50,000 ft.)

Weight XCU + cradle: 12.5 kg (27.6 lbs.)

Weight XCU: 7.8 kg (17.2 lbs.)

Power requirement: AC 100V/240V, 47 to 63 Hz

Power connector: IEC type, 3-pin male

Power consumption: Total power (Camera + XCU) 450W max.

Baseband Connectivity

Connectors (4K mode)

Teleprompter in: BNC 1x (loop-through output), (C)VBS, 1.0 Vp-p, 75Ω

Reference in: 1x (loop-through output), 1.0 Vp-p, 75Ω HD tri-level sync or SD blackburst

4K UHD: 2x / 3G HD-SDI: 4x, BNC 0.8 Vp-p, 75Ω Quad or 2SI, Level-A

HD-SDI out: BNC 1x 0.8 Vp-p, 75Ω, SMPTE ST 292, 1080i/720p at 50/59.94 Hz or SMPTE ST 425A, 425B, 1080p at 50/59.94 Hz

Signaling in/out: D-sub 15-pin – male, preview, green tally (call – dry contact), yellow tally (iso – dry contact), red tally (on air – dry contact), remote audio level control (22-64 dB), DC

Auxiliary in/out: D-sub 9-pin – female, private data in/out – 100 kb TTL (RS-232)

Control data: RJ-45 connector for C2IP (camera control)

Control data: RJ-45 connector for IP trunk up to 1 GbE

Hybrid fiber connector: LEMO hybrid acc. SMPTE ST 304 (other fiber connectors on request)

External video in: 3x HD-SDI (1.5 Gb/3.0 Gb) or SD-SDI 0.8 Vp-p, 75Ω

Input 1 (loop-through output) / Inputs 2 and 3 (no loop-through output)

Connectors (HD/3G 1X/3X/6X modes)

Teleprompter in: BNC 1x (loop-through output), (C)VBS, 1.0 Vp-p, 75Ω

Reference in: 1x (loop-through output), 1.0 Vp-p, 75Ω HD tri-level sync or SD blackburst

HD-SDI out*: BNC 6x 0.8 Vp-p, 75Ω, SMPTE ST 292, 1080i/720p at 50/59.94 Hz

HD-SDI out (live/effect)*: BNC 2x 0.8 Vp-p, 75Ω, SMPTE ST 292, 1080i/720p at 50/59.94 Hz

HD-SDI monitoring out: BNC 1x 0.8 Vp-p, 75Ω, SMPTE ST 292, 1080i/720p at 50/59.94 Hz

SD-SDI out: BNC 2x 0.8 Vp-p, 75Ω, SMPTE ST 259 ITU-R, BT.601

SD-SDI monitoring out: BNC 1x 0.8 Vp-p, 75Ω, SMPTE ST 259 ITU-R, BT.601

Composite video monitoring output: BNC 1x 1.0 Vp-p, 75Ω (CVBS text with video, for viewing purposes)

Signaling in/out: D-sub 15-pin – male, preview, green tally (call – dry contact), yellow tally (iso – dry contact), red tally (on air – dry contact), remote audio level control (22-64 dB), DC

Auxiliary in/out: D-sub 9-pin – female, private data in/out – 100 kb TTL (RS-232)

Control data: RJ-45 connector for C2IP (camera control)

Control data: RJ-45 connector for IP trunk up to 1 GbE

Hybrid fiber connector: LEMO hybrid acc. SMPTE ST 304 (other fiber connectors on request)

External video in: 3x HD-SDI (1.5 Gb/3.0 Gb) or SD-SDI 0.8 Vp-p, 75Ω

Input 1 (loop-through output) / Inputs 2 and 3 (no loop-through output)

2-ch. audio: Audio out, 2x XLR-3 – 0/+6 dBu (±1.5 dB, max. 18 dBu, 600Ω, gain max. 70 dB)

Frequency response: 40 Hz to 15 Hz, (+1/-3 dB, 1 kHz, -10 dBu output level)

Distortion: Less than 0.5% (100 Hz/1 kHz, +6 dBu out, 600Ω)

S/N ratio: 58 dB (unweighted RMS)

AES-EBU 1+2: BNC 75Ω, digital audio output Audio 1 and 2

AES-EBU 3+4: BNC 75Ω, digital audio output Audio 3 and 4

Intercom in/out (2/4-wire intercom): D-sub 15-pin, female – program in, production in/out, engineering in/out – in: 0 or 6 dBu, out: 0 or 6 dBu (±2 dB, max. 12 dBu)

Frequency response: 150 Hz to 6 kHz (1 kHz, -10 dBu output level)

Distortion: Less than 2% (1 kHz, +12 dBu level)

* Notes:

- 8x 1.5G video outputs (in 1X speed 720p, 1080i)
- 6x 3G and 2x 1.5G video outputs (in 1X speed 1080p)
- 2x three phases on 6x 1.5G and 2x 1.5G live (in 3X speed 720p, 1080i)
- 2x three phases on 6x 3G and 2x 6G live (in 3X speed 1080p)
- 2x six phases on 6x 3G (dual-link) and 2x 1.5G live (in 6X speed 720p, 1080i, 1080p)
- During single-speed HDR operation, some of the signals will be with SDR mapping and some of the signals will be with HDR mapping

Camera Adapters

The dockable implementation of LDX cameras provides fast and easy configuration of the camera transmission system. For the XF transmission systems, a compatible transmission adapter — the LDX XF Universe — has been developed.

The feature set of the XF Universe camera adapter is in line with the latest generation of 3G Triax and 3G Fiber transmission adapters and offers several improvements for users in different areas such as:

- Improved operation with crane/robotic heads
- Improved maximum power from the DC output to directly power various teleprompters
- Improved user interface area with illuminated buttons and indicator LEDs for easy control during installation and operation
- Approximately 1 kg (2.2 lbs.) lower weight, making the total camera system weight to be one of the lowest available
- More than 25% reduction in power consumption, which translates into a much lower operating temperature as well
- 1 Gbit IP trunk in all single speed modes

The combination of dockable high-speed/4K camera heads, LDX XF Universe camera adapters and any of the XCU XF or XCU UXF dockable base stations, provides the means for LDX high-speed/4K camera systems to deliver the ultimate flexibility for even the most demanding of applications.



SPECIFICATIONS

LDX XF Universe Camera Adapter

Power requirements: Hybrid fiber powered or 12 VDC (local)

Operating temperatures: -20 to +45°C (-4 to +113°F)

Storage temperatures: -25 to +70°C (-13 to +158°F)

Weight (approx.): 2.1 kg (4.6 lbs.)

Dimensions (L x W x H): 222.1 x 132.7 x 212.1 mm (8.7 x 5.2 x 8.4 in.) without handgrip

Fiber connector: Swivel hybrid fiber connector SMPTE ST 304 Lemo (other connectors available on request)

Cable length: 3,000 m (10,000 ft.) max. using SMPTE ST 311 hybrid fiber cable

Analog VF output or AES/EBU audio input: BNC connector 1.0 Vp-p; 75Ω

VF output or main output: BNC connector 1.0 Vp-p; 75Ω

Reference input: BNC connector 0.6 Vp-p; 75Ω HD tri-level reference signal

EXT video output connector: BNC connector 1.0 Vp-p; 75Ω

Teleprompter output or analog ref input: BNC connector 1.0 Vp-p; 75Ω

Auxiliary: 20-pin data connector with Tracker intercom, remote control lines and studio signaling

Rear microphone inputs: 2x XLR-3, balanced, +48V phantom power

Intercom: XLR-5 with 3 channels (engineering, production and program)

DC power input: 12V/7A max. (11 to 17V), XLR-4 male

Script light power output: 12V (100 mA), 4-pin Hirose

DC power output: 12V/4A, XLR-4 female



LDX C86^N Compact Series Cameras



The **LDX C86^N Compact Series** are self-contained native 4K UHD cameras in a small form factor. They are an extension to the revolutionary LDX 86^N range of cameras. They take compact cameras to a new performance level with native 4K UHD (3840x2160) and native HD (1920x1080) image capture, using three unique 3840x2160p 4K Xensium^{HAWK} CMOS imagers with DPM^{Ultra} (dynamic pixel management) functionality. In addition, the LDX C86^N range gives you the same familiar GV-eLicense upgrade path as the other LDX 86 Series and LDX 86^N Series cameras, so that you always have the camera that you need.

LDX C86^N Compact Series cameras provide the same image performance and all of the control features of the LDX 86^N Series system cameras in a smaller mechanical package. This produces the same level of quality from angles and in areas that can be very space constrained. This delivers a new level of image performance and business flexibility for all applications where native 4K UHD cameras with a compact form factor are required. Five models are available: LDX C86^N WorldCam, LDX C86^N 4K, LDX C86^N Universe, LDX C86^N HiSpeed and LDX C86^N XtremeSpeed. Users can upgrade through the LDX C86^N range for increased resolution, higher speed or both with the GV-eLicense program (see below).

LDX C86^N WorldCam — Offers all the production formats of the LDX 86^N WorldCam (HD/PsF/3G) plus an upgrade path via GV-eLicense directly to native 4K (LDX C86^N 4K) as well as directly to 3X HD (LDX C86^N HiSpeed) or 6X HD/6X 3G (LDX C86^N XtremeSpeed), and then to all LDX 86^N Series formats (LDX C86^N Universe).

LDX C86^N 4K — Adds native 4K UHD (3840x2160p) acquisition to the LDX C86^N WorldCam.

LDX C86^N Universe — Offers “universal format” support with switchable 1X/3X/6X native HD, 1X/3X/6X native 3G and 1X native 4K from a single camera for ultimate flexibility and equipment utilization.

LDX C86^N HiSpeed (HS) — Offers 1X/3X native HD acquisition for super slow-motion acquisition, as well as all the production formats of the LDX C86^N WorldCam. It can be upgraded to 1X/3X/6X HD and 1X/3X 3G (LDX C86^N XtremeSpeed) as well as adding 1X native 4K (LDX C86^N Universe).

LDX C86^N XtremeSpeed (XS) — Adds 6X HD and 1X/3X/6X 3G acquisition to the LDX C86^N HiSpeed for super slow-motion acquisition, and can be upgraded to include 1X native 4K (LDX C86^N Universe).

There are many applications for a compact and cost-effective addition or alternative to system cameras. However, up to now for 4K UHD applications, cameras with a small form factor did not offer the flexibility or performance level of comparable system cameras with a larger form factor. In these applications — that include cameras mounted on a remote pan/tilt-head, sliding rail system, as Spidercams or in combination with gyroscopic stabilizing systems — some of the typical features of a system camera (such as the intercom connection, the hand grip, the shoulder pad and the viewfinder mount) are not needed. On the other hand, a more compact and lightweight camera body, which is also easier to mount, provides better integration for robotic heads in studios, for fixed-mounted camera positions, on Steadicam systems, on camera cranes or on 3D rigs. In addition, cameras with a smaller form factor can be used in shooting positions where larger cameras have not previously been usable. These include dangerous camera positions, such as a motor racetrack or any other camera position very close to the action.

The LDX C86^N Compact Series of cameras from Grass Valley, a Belden Brand, provides for native 4K UHD, 3G and HD acquisition when you want the sharpest and clearest images possible. In addition, the ability for the lower feature-set camera models to be upgraded in the field with GV-eLicenses — on a 1-day, 7-day or perpetual basis — to the higher feature-set models of the range. Optional HDR for LDX C86^N Compact Series is available using a weekly or perpetual GV-eLicense.

The LDX C86^N Compact Series delivers a combination of unique multiformat native acquisition benefits not found in any other compact camera system:

- Three Xensium^{HAWK} CMOS imagers with DPM^{Ultra}:
 - Native 4K UHD 3840x2160 acquisition
 - Native HD/3G 1920x1080 acquisition
 - Extended color gamut supporting ITU-R BT.2020
 - No sensitivity to fast camera movements with short exposure time in HD/3G modes with global shutter
 - No sensitivity to short light flashes
 - Optional native HDR operation in all single speed formats

Designed for Specific Applications

In addition to establishing a new standard for compact native 4K UHD image acquisition, the design of the LDX C86^N Compact Series cameras focuses strongly on the specific requirements for cameras with a smaller form factor. All of the typically required interfaces are available directly on the camera head. Additionally, several new interfaces are available, including a USB connection for the management of GV-eLicenses, firmware upgrades and scene file storage. The cameras also offers an HDMI interface for connecting to any HD display with an HDMI or DVI interface — to be used as a camera viewfinder or monitoring display. The user-friendliness of LDX Compact cameras has been further improved by using a streamlined menu structure that allows operators to quickly access commonly used functions.

Engineered for the Bottom Line

With LDX C86^N Compact Series 4K UHD cameras, Grass Valley has paid particular attention to the ongoing costs of operation. As with the HD only LDX C82 Compact Series, they are fully integrated with the Ethernet-based

C2IP camera control system as a powerful link to remote production capabilities. This smart capability provides full remote control over all camera controls via any IP-link and includes DigiTally — an all-digital remote tally protocol over IP.

The unique GV-eLicense program offers the ultimate flexibility in format support and feature-set availability. With GV-eLicense, LDX C86^N Compact Series camera users have the choice of upgrading their cameras in two different ways: A perpetual upgrade license provides an upgrade to the next camera in the range. Multiple licenses may be purchased to upgrade cameras by more than one level (e.g., LDX C86^N XtremeSpeed or LDX C86^N 4K to LDX C86^N Universe). With a 1-day term or 7-day term upgrade license, the same flexibility is available, but for a limited timeframe and for a lower cost. Multiple licenses may be purchased to extend 1-day or 7-day term upgrade licenses. To enhance convenience and user flexibility, the B.O.W.L. (bunch of weekly/dailylicenses) licensing system offers users a way to preorder any number of 1-day or 7-day licenses and activate them for any camera whenever needed.

GV-eLicense PROGRAM

Perpetual license: Perpetual upgrade to the next camera in the range

7-day term license: 7-day (weekly) term upgrade to the next camera in the range

1-day term license: 1-day (24 hours) term upgrade to the next camera in the range. They are available in packs of 10 1-day licenses.

HDR weekly or perpetual license: 7-day or perpetual licenses for the addition of HDR operation in all single speed formats for all LDX C86^N Series camera heads is available. (1-day HDR licenses are not available.)

Multiple licenses may be purchased to upgrade cameras by more than one level (e.g., LDX C86^N XtremeSpeed or LDX C86^N 4K to LDX C86^N Universe). Multiple 1-day and 7-day term licenses may be purchased for extended term upgrades. The B.O.W.L. licensing system provides a way to preorder any number of 1-day or 7-day licenses and activate them whenever needed without having to place individual orders. No credit is given for the purchase of 1-day or 7-day term licenses towards the purchase of a perpetual license.

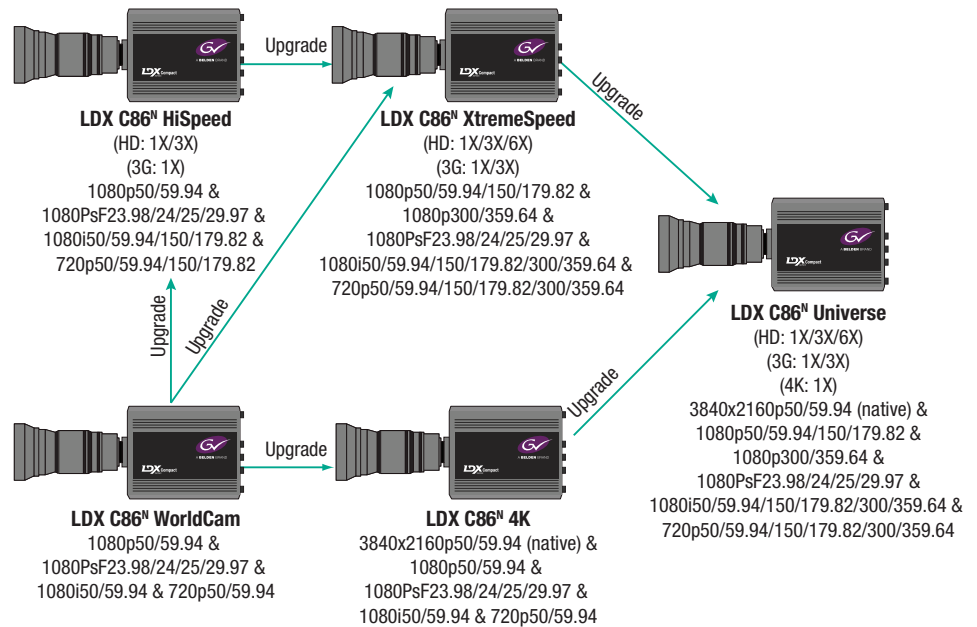

SPECIFICATIONS

General

Power: Approx. 45W (typical, depends on operational mode)
Temperature range: -20° to +45° C (-4° to 113° F) (operating)
Water protection: Compliant to IPX0
Weight: approx. 2.5 kg (5.1 lbs.)
Dimensions (approx.):
 Width: 113 mm (4.45 in.)
 Depth: 156 mm (6.14 in.)
 Height: 140 mm (5.51 in.)

Camera

Pick-up device: 3x 2/3" 4K Xensium^{hawk} CMOS imagers with DPM^{ultra}
Picture elements: 3840x2160
Smear: no vertical smear
Shutter: no mechanical shutter
Optical system: F1.4 prism
Lens mount: 2/3" Bayonet type
Optical filter wheels: 2x motorized wheels
Optical filters on first wheel: clear, 1/4 ND, 1/16 ND, 1/64 ND
Optical filters on second wheel: clear, 4P-star, 5µ OLPF, cap-filter
Electronic color correction: 3200°K, 5600°K, 7500°K, FL, 2 AWB presets, Var, continuous auto white

Video Modes

LDX C86^o Compact WorldCam switchable: 1080p50/59.94, 1080PsF23.98/24/25/29.97, 1080i50/59.94 & 720p50/59.94
LDX C86^o Compact 4K switchable: 3840x2160p50/59.94, 1080p50/59.94, 1080PsF23.98/24/25/29.97, 1080i50/59.94 & 720p50/59.94
LDX C86^o Compact HiSpeed switchable: 1080p50/59.94, 1080PsF23.98/24/25/29.97, 1080i50/59.94/150/179.82 & 720p50/59.94/150/179.82
LDX C86^o Compact XtremeSpeed switchable: 1080p50/59.94/150/179.82, 1080PsF23.98/24/25/29.97, 1080i50/59.94/150/179.82/300/359.64 & 720p50/59.94/150/179.82/300/359.64
LDX C86^o Compact Universe switchable: 1080p50/59.94/150/179.82, 1080PsF23.98/24/25/29.97, 1080i50/59.94/150/179.82/300/359.64 & 720p50/59.94/150/179.82/300/359.64

Sensitivity

3840x2160p50/59.94:
 Sensitivity at 2000 lux:
 F10.0 to 5.0 (50 Hz)*
 F9.0 to 4.5 (59.94)*
1080p50/59.94/150/179.82, 1080PsF23.98/24/25/29.97, 1080i50/59.94/150/179.82/300/359.64 & 720p50/59.94/150/179.82/300/359.64:
 Sensitivity at 2000 lux:
 F10.0 (1080i50, 720p50 & 1080p50)
 F9.0 (1080i59.94, 720p59.94 & 1080p59.94)
 F6.0 (1080i150, 720p150 & 1080p150)
 F5.2 (1080i179.82, 720p179.82 & 1080p179.82)
 F4.3 (1080i300 & 720p300)
 F3.7 (1080i359.64 & 720p359.64)
 F14.0 (1080PsF23.98/24/25)
 F13.0 (1080PsF29.97)

Notes: All figures are valid for operation in native acquisition modes.

S/N ratio: 60 dB typical
Aspect ratio: 16:9
Modulation depth: 60% (typical) at 800 TV lines (27 MHz) in 1080i50/59.94 & 720p50/59.94 modes
Digital resolution: Floating point A/D conversion with 16-bit performance and with 34-bit processing in RGB
Horizontal resolution: >1,000 TV lines (HD), >2,000 TV lines (4K UHD)
Gain selection: -6 dB to +12 dB in 3 db steps (user-definable presets) or continuous master gain

Connectivity

Lens iris connector: 12-pin female Hirose (front)
Lens zoom/focus connector: 12-pin male Hirose (front)
USB: GV-eLicense, scene files, service
HDMI: viewing
Ethernet RJ-45: C2IP camera control
Tally control/RS-232/RS-422/Private data: D-connector– 15 pin
4x HD/3G SDI outputs: BNC 0.8 Vp-p, 75Ω, SMPTE ST 292, 424/425
 @ 4K operation they carry 4x 2SI 3G HD-SDI
 @ High-speed operation they carry 3x phases of HD/3G SDI and 1x HD/3G SDI for combined live output
HD-SDI monitoring video output: BNC 0.8 Vp-p, 75Ω, SMPTE ST 292, 424/425
Genlock input: BNC CVBS/BB/tri-level
Power input: XLR-4 male (10.5-17 VDC)

Control Buttons and LED Indications

PickMe
 Menu control: menu select, rotary control
 Color bar button
 Info button
 Filter wheel selection
 Standard file recall
 2 user-assignable buttons
 2-digit display: power on, camera number
 Tally LEDs: on-air, ISO, call

* Specifications depend on the selected sensitivity mode.



LDX C86 Compact Series Cameras



The **LDX C86 Compact WorldCam** is a very powerful self-contained HD/3G camera with an upgrade option for native HDR operation. The **LDX C86 Compact HiSpeed** (LDX Compact HS) and **LDX C86 Compact XtremeSpeed** (LDX Compact XS) are the world's first self-contained high-speed cameras in a small form factor. They are an extension to the revolutionary LDX range of cameras — built for business flexibility and operational excellence — with superior imaging, processing and performance.

There are many applications for a compact and cost-effective addition or alternative to system cameras. However, up to now for many applications, cameras with a small form factor did not offer the flexibility or performance level of comparable system cameras with a larger form factor.

The LDX C86 Compact high-speed cameras provide the same image performance and all of the control features of the LDX 86 HiSpeed and LDX 86 XtremeSpeed system cameras (with the exception of the AnyLightXtreme feature) in a smaller mechanical package. This produces the same level of quality from angles and in areas that can be very space constrained, bringing a new level of image performance and business flexibility for all applications where high-speed cameras with a compact form factor are required. This can be for various production requirements, such as high-speed compact cameras mounted on compact remote heads, on rail systems, as Spidercams, or in combination with gyroscopic stabilizing systems. The requirements can also be for cost/efficiency reasons where smaller cameras might be used instead of larger and more expensive system cameras. These applications include high-speed compact cameras mounted on robotic heads in studios, for fixed-mounted camera positions, on Steadicam systems, on camera cranes, or on 3D rigs.

In these applications, some of the typical features of a system camera — such as the intercom connection, the hand grip and shoulder pad, or the viewfinder mount — are not needed. On the other hand, a more compact and lightweight camera body, which is also easier to mount, provides better integration for these applications. In addition, cameras with a smaller form factor can be used at shooting positions where larger cameras have not previously been usable. These include dangerous camera positions at a motor race track or any other camera position very close to the action. Since capturing emotion is one of the main reasons for the use of high-speed imaging, it is often necessary to get close to where the action is to be able to get the best viewing positions.

All these different applications can be found in use at production companies, broadcasters and more.

Designed for Specific Applications

In addition to establishing a new standard for compact high-speed image acquisition, the design of the LDX C86 Compact cameras focuses strongly on the specific requirements for cameras with a smaller form factor. All of the typical interfaces which are required are available directly on the camera head. Additionally, several new interfaces are available which include a USB connection for the management of GV-eLicenses, firmware upgrades and scene file storage. The cameras also offers an HDMI interface for connecting to any HD display with an HDMI or DVI interface to be used as a camera viewfinder or monitoring display. The user-friendliness of LDX Compact high-speed cameras has been further improved by using a streamlined menu structure that allows operators to access commonly used functions more quickly.

LDX C86 Compact high frame rate cameras fully integrate with the Grass Valley K2 Dyno and LiveTouch Replay Systems.

Engineered for the Bottom Line

LDX Compact HS provides multiformat single speed 1080p, 1080i and 720p acquisition as well as 3X speed in 1080i or 720p as standard functionality.

LDX Compact XS incorporates all of the features of the LDX Compact HS and adds 6X speed in 1080p, and 6X speed in 1080i or 720p as well.

With LDX C86 Compact high-speed cameras, Grass Valley has paid particular attention to the ongoing costs of operation. As with the standard speed cameras in the LDX C82 Compact series, they are fully integrated with the Ethernet-based C2IP camera control system as a powerful link to remote production capabilities. This smart capability provides full remote control over all camera controls via any IP-link and includes DigiTally — an all-digital remote tally protocol over IP.

LDX Compact high-speed cameras offer the flexibility to adjust capital expenses and operating expenses to match a variety of business goals and factors. The LDX cameras are about more than just pretty pictures: LDX cameras are built to face the realities of live production and broadcast — today and tomorrow.

The unique GV-eLicense program offers users the ultimate flexibility in format support and feature set availability. With GV-eLicense, LDX Compact WorldCam or HS camera users have the choice of upgrading their cameras in two different ways: A perpetual upgrade license provides an upgrade from a LDX Compact WorldCam to a LDX Compact HS or from a LDX Compact HS camera to a LDX Compact XS camera. With a 1-day or 7-day term upgrade license, the same flexibility is available, but for a limited timeframe and for a lower cost. Multiple licenses may be purchased to extend 1-day or 7-day term upgrade licenses. To enhance convenience and user flexibility, the B.O.W.L. (bunch of weekly/daily licenses) licensing system offers users a way to preorder any number of 1-day or 7-day licenses and activate them for any camera whenever needed with a secured web-based activation tool. The ability to upgrade to the next level camera, on a perpetual, 1-day or 7-day term basis, provides the ultimate in production flexibility.



LDX C86 COMPACT SERIES SPECIFICATIONS

General

Power: Approx. 45W (typical, depends on operational mode)
Temperature range: -20° to +45°C (-4° to 113°F) (operating)
Water protection: Compliant to IPX0
Weight: approx. 2.5 kg (5.1 lbs.)
Dimensions (approx.):
 Width: 113 mm (4.45 in.)
 Depth: 156 mm (6.14 in.)
 Height: 140 mm (5.51 in.)

Camera

Pick-up device: 3 x 2/3" Xensium-FT CMOS
Picture elements: 1920x1080
Smear: no vertical smear
Shutter: no mechanical shutter
Optical system: F1.4 prism
Lens mount: 2/3" Bayonet type
Optical filter wheels: 2x motorized wheels
Optical filters on first wheel: clear, 1/4 ND, 1/16 ND, 1/64 ND
Optical filters on second wheel: clear, 4P-star, soft focus
Electronic color correction: 3200°K, 5600°K, 7500°K, FL, 2 AWB presets, Var, continuous auto white
Exposure: Electronic exposure down to 1/1000 sec

Video Modes

LDX C86 WorldCam switchable: 1080p50/59.94, 1080PsF23.98/24/25/29.97, 1080i50/59.94, 720p50/59.94
LDX C86 Compact HiSpeed switchable: 1080p50/59.94, 1080PsF23.98/24/25/29.97, 1080i50/59.94/150/179.82, 720p50/59.94/150/179.82
LDX C86 Compact XtremeSpeed switchable: 1080p50/59.94, 1080PsF23.98/24/25/29.97, 1080i50/59.94/150/179.82/300/359.64, 720p50/59.94/150/179.82/300/359.64

Sensitivity at 2000 lux:

F12.0 (1080i50, 720p50, 1080p50)*
 F11.0 (1080i59.94, 720p59.94, 1080p59.94)*
 F6.9 (1080i150, 720p150, 1080p150)*
 F6.3 (1080i179.82, 720p179.82, 1080p179.82)*
 F4.9 (1080i300, 720p300)*
 F4.5 (1080i359.64, 720p359.64)*
 F18.0 (1080PsF23.98/24/25)
 F16.0 (1080PsF29.97)

S/N ratio: 62 dB typical

Aspect ratio: 16:9

Modulation depth: 60% (typical) at 800 TV lines (27 MHz) in 1080i50/59.94 & 720p50/59.94 modes

Digital resolution: Floating point A/D conversion with 16-bit performance and with 34-bit processing in RGB

Horizontal resolution: >1,000 TV lines

Gain selection: -6 dB to +18 dB in 3 dB steps (user-definable presets) or continuous master gain

Connectivity

Lens iris connector: 12-pin female Hirose (front)
Lens zoom/focus connector: 12-pin male Hirose (front)
USB: GV-eLicense, scene files, service
HDMI: viewing
Ethernet RJ-45: C2IP camera control
Tally control/RS-232/RS-422/Private data: D-connector– 15 pin
4x HD/3G SDI outputs: BNC 0.8 Vp-p, 75Ω, SMPTE ST 292, 424/425
 @ High-speed operation they carry 3x phases of HD/3G SDI and 1x HD/3G SDI for combined live output
HD-SDI monitoring video output: BNC 0.8 Vp-p, 75Ω, SMPTE ST 292, 424/425
Genlock input: BNC CVBS/BB/tri-level
Power input: XLR-4 male (10.5-17 VDC)

Control Buttons and LED Indications

PickMe
 Menu control: menu select, rotary control
 Color bar button
 Info button
 Filter wheel selection
 Standard file recall
 2 user-assignable buttons
 2-digit display: power on, camera number
 Tally LEDs: on-air, ISO, call

* Format support depends on model

GV-eLicense PROGRAM

Perpetual license: Perpetual upgrade from LDX Compact WorldCam to LDX Compact HiSpeed or LDX Compact HiSpeed to LDX Compact XtremeSpeed

7-day term license: 7-day (weekly) term upgrade from LDX Compact WorldCam to LDX Compact HiSpeed, and then to LDX Compact XtremeSpeed

1-day term license: 1-day (24 hours) term upgrade from LDX Compact WorldCam to LDX Compact HiSpeed, and then to LDX Compact XtremeSpeed. They are available in packs of 10 1-day licenses

Multiple 1-day or 7-day term licenses may be purchased for extended 1-day or 7-day term upgrades. The B.O.W.L. licensing system provides a way to preorder any number of 7-day licenses and activate them whenever needed without having to place individual orders. No credit is given for the purchase of 1-day or 7-day term licenses towards the purchase of a perpetual license.

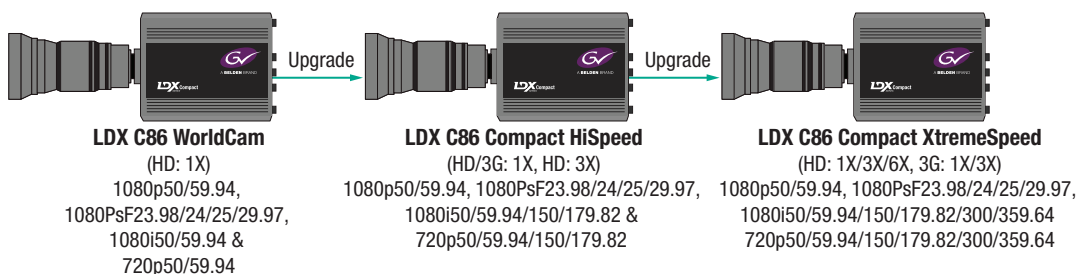

LDX 82 Series

HDR-capable Advanced Imaging Camera System

A revolutionary series of cameras built for business flexibility and operational excellence, with superior imaging, processing and performance, supporting advanced 1080p formats including wide color gamut and optional native HDR operation.

Grass Valley cameras are technology-leading imaging systems with a history of innovative developments and the recipient of seven Emmy® Awards. Grass Valley offers a very comprehensive portfolio of live HD/3G LDX production camera systems that include a complete line of 3G Transmission solutions, an extremely powerful camera control solution and a wide range of dedicated camera accessories such as viewfinders and converters.

High-definition video cameras from Grass Valley — the LDX 82 Series, are a unique line of advanced imaging cameras built around Xensium-FT imagers, a new generation of camera imagers which combine all the advantages from CMOS imaging technology such as high sensitivity in all video modes, high dynamic range and low power consumption. They also include global shutter behavior which was before only possible with CCD imagers. Xensium-FT imagers deliver unmatched sensitivity and picture quality even in the most demanding of applications.

Productions need freedom, flexibility and adaptability. Grass Valley understands the value of being able to choose the right solution to fit specific requirements. The LDX 82 Series includes the unique GV-eLicense program, where users have the choice of upgrading their cameras perpetually or by a 7-day term. An enhancement to the 7-day term license is the B.O.W.L. licensing option (simply, a bunch of weekly licenses) where users can pre-order any number of 7-day licenses and activate them whenever needed — without the need to go through an order process.

A complete line of 3G transmission solutions are available to fulfill all the requirements which might be found with many different kinds of productions. With the XCU dockable base station, Grass Valley offers a revolutionary concept in camera transmission. XCU is a real game-changer for video production companies such as OB truck operators as it helps to minimize operational costs and streamlines reconfiguration for each production. XCU is made out of two distinct units: the base station and a fixed cradle. The cradle can be mounted and wired into equipment racks, and the base station can be docked into different cradles as needed. All specific settings needed for the production environment are memorized in memory inside the cradle and will automatically configure the base station when it's powered on.



The LDX 82 Series camera heads are fully compatible to the XF Fiber transmission system, which offers a seamless path from baseband only to full IP connectivity.

To control all the cameras in a production environment, a powerful and flexible camera control solution has been developed. C2IP was the first camera control system on the market using Ethernet and TCP/IP open IT standards. Even the largest multicamera systems can be fully controlled over an Ethernet-based networked. With C2IP camera control system, basic camera settings can be controlled from select Grass Valley video production switchers. Now cameras can be an integral part of the total facility control system.

From the RefleX SuperXpander kits for large lenses, high-resolution viewfinders, to lighted script boards, Grass Valley camera accessories are specifically designed to enhance camera operation and make users more efficient and creative.

More than 50 years of imaging innovation has led to a new standard in live broadcast acquisition: LDX 82 Première provides standard multiformat 1080i & 720p acquisition, LDX 82 Elite adds 1080PsF, while LDX 82 WorldCam (available as a software upgrade license only) rounds out the series with 1080p production (the LDX 86 WorldCam provides these same features, but is upgradable to 4K operation, and further upgradable to HD 1X/3X/6X and 3G 1X/3X as well). Upgrading to the next level camera can be perpetual or on a 7-day term basis for the ultimate in production flexibility.

The LDX 82 Series cameras are the ultimate achievement based on a proud legacy capturing the world's historic moments. In live television, there are no second chances to make up missing details at the crucial moment of acquisition, and HD broadcasting is all about telling the story through those details.

The introduction of the next-generation Grass Valley LDX 82 Series provides a multitude of capabilities and benefits to users. The camera's reliability has been strenuously tested for the harsh demands of live production; its imaging is beyond imagination; a huge advance has been made in ease of use and special attention paid to the ergonomic design of the camera head.

Stunning Images

LDX camera models provide stunning images, based upon new, custom-designed Xensium-FT 2/3-inch CMOS imagers. The renowned Grass Valley imaging design team engineered the new Xensium-FT CMOS imagers to make artifact-free capture possible along with a significant improvement in sensitivity.

By supporting the BT.2020 wide color gamut, the LDX 82 Series offer outstanding color reproduction addressing the requirements for future-proofed advanced HD formats.

Via the XDR GV-eLicense, HDR operation with a dynamic range of at least 15 F-stops can be provided. Both HDR OETFs with SMPTE ST 2084, as well as HLG, are natively produced inside the camera head avoiding any lossy conversion between different non-standardized transfer functions.

To make images look their best, LDX incorporates TrueTexture — a unique feature to preserve texture throughout all processing parameters.

Another imaging innovation is ArtTouch, an intuitive interface between the operator and hardwired controls, which significantly enhances artistic possibilities within a live broadcast. Looking back at the last few years in broadcasting, a lot has changed with respect to the way productions are being managed from an artistic point of view. To an increasing extent, there is a close collaboration between creative directors and the camera shaders, who adjust each camera feed to perfection.

With the LDX 82 Series, a completely new level of artistic camera control is included, to support today's and tomorrow's requirements for live shading flexibility. By using the full latitude of the custom-designed Xensium-FT CMOS imager, control of every aspect of the image is available, so any degree of creative touch can be applied.

The LDX 82 Series provides enhanced colorimetry, color-matching and picture performance. Color temperature and tint are just two of the parameters that can be simultaneously adjusted across multiple cameras. Knee saturation control maintains a correct hue by using secondary compression. An advanced chromatic lens aberration correction and sharpness solution (CLASS) is applied, and offers impressive sharpness improvements mainly on the left and right regions of the image. Other features assist in aperture correction, detail preservation and more.

Designed for the Operator

In addition to establishing a new standard for image acquisition, the design of the LDX 82 Series focuses strongly on operator comfort and usability. In addition to the unique zoom control demand build into the camera hand grip, Grass Valley proudly introduces the world's first side grip (standard with LDX 82 Elite).

The LDX 82 Series offers even more operational excellence. Button layouts and control knobs are ergonomically designed to allow the operator to find the right adjustments easily. Full control flexibility is possible thanks to well-dimensioned control knobs. With the easily accessible separated "info" knob, all important information is displayed in the viewfinder instantaneously. The user-friendliness of LDX cameras has been further improved by using a streamlined menu structure that allows operators to access commonly used functions more quickly.

Engineered for the Bottom Line

The problem with buying a camera today is that it is not always clear what will be needed tomorrow. This leads to one of three possibilities: upgrade to new cameras in a few years, pay today for features that hopefully will be used in a few years, or market forces aligned perfectly so that the cameras provide exactly what is needed today and tomorrow.

The LDX 82 Series changes all that. Buy what is needed today, and upgrade to the next level camera or higher as needed later.

With the unique LDX 82 Series GV-eLicense program, users now have the ultimate flexibility in format support and feature set availability. With GV-eLicense, LDX 82 Series users have the choice of upgrading their cameras in two different ways. A perpetual upgrade license provides an upgrade from any lower model of the range to the next higher model of the range. With a 7-day term upgrade license, the same flexibility is available, but for a lower cost. Licenses may be purchased to upgrade cameras or to extend 7-day term upgrade licenses. For even greater flexibility, the ordering procedure can be simplified with the B.O.W.L. licensing system. With B.O.W.L., customers can preorder any number of 7-day licenses and activate them whenever needed.

SPECIFICATIONS

LDX 82 Première (Common to all LDX 82 Series Cameras unless otherwise stated)

Camera Head

General:
 Temperature range: -20° to +45°C (-4° to 113°F) (operating)
 Weight:
 2.1 kg (4.6 lbs.) (including handgrip and shoulder pad)
 Dimensions: width: 170 mm, depth: 200 mm, height: 180 mm (6.7 x 7.9 x 7.1 in.)
 Power: Supplied through the transmission adapter

Camera:
 Pick-up device: 3x2/3" Xensium-FT CMOS
 Picture elements: 1920x1080
 Smear: no vertical smear
 Shutter: no mechanical shutter
 Optical system: F1.4 prism
 Lens mount: 2/3" Bayonet type
 Optical filter wheels: 2x motorized wheels
 Optical filters on first wheel: clear, 1/4 ND, 1/16 ND, 1/64 ND
 Optical filters on second wheel: clear, 4P-star, soft focus
 Electronic color correction: 3200°K, 5600°K, 7500°K, FL, 2 AWB presets, Var, continuous auto white
 Exposure: electronic exposure down to 1/1000 sec

Video modes:
 Switchable: 1080i50/59.94 & 720p50/59.94
 Sensitivity at 2000 lux:
 – F12.0 (1080i50, 720p50 and 1080p50)
 – F11.0 (1080i59.94, 720p59.94 and 1080p59.94)
 – F18.0 (1080PsF23.98/24/25)
 – F16.0 (1080PsF29.97)
 S/N ratio: 62 dB typical
 Aspect ratio: 16:9
 Modulation depth: 60% (typical) at 800 TV lines (27 MHz) in 1080i50/59.94 & 720p50/59.94 modes
 Digital resolution: Floating point A/D-conversion with 16-bit performance and with 34-bit processing in RGB
 Horizontal resolution: >1,000 TV lines
 Gain selection: -6 dB to +18 dB in 3 dB steps (user-definable presets) or continuous master gain

Connectivity:
 Front microphone input: XLR-3 female, balanced, phantom +48V selectable
 USB
 Ethernet RJ-45
 Lens connector: Hirose 12-pin
 Viewfinder connector: 20-pin and HDMI
 Control buttons:
 PickMe
 Info
 Menu control
 Return A / Return B
 Intercom production/engineering
 Filter wheel selection
 Standard file recall
 4 user assignable
 Control switches:
 On/off
 Color bar
 Gain selection
 Color temperature
 Exposure time
 White balance

Accessories

- 2" LCD viewfinder
- 7" LCD viewfinder (economic)
- 7" LCD viewfinder (native HD)
- 7.4" OLED viewfinder

Note: LDX 82 Première can be upgraded to LDX 82 Elite. Upgrades of more than one level may be achieved with multiple licenses.

LDX 82 Elite

Video Modes

Switchable: 1080PsF23.98/24/25/29.97, 1080i50/59.94 & 720p50/59.94

Note: LDX 82 Elite can be upgraded to LDX 82 WorldCam. Available as a software upgrade license only.

LDX 82 WorldCam

Video Modes

Switchable: 1080p50/59.94, 1080PsF23.98/24/25/29.97, 1080i50/59.94 & 720p50/59.94

GV-eLicense PROGRAM

Perpetual license: Perpetual upgrade to the next camera in the range

7-day term license: 7-day (weekly) term upgrade to the next camera in the range

HDR weekly or perpetual license: 7-day or perpetual licenses for the addition of true 15 F-stop HDR operation in all single speed formats for all LDX 82 Series camera heads is available.

Multiple licenses may be purchased to upgrade cameras. Multiple 7-day term licenses may be purchased for extended 7-day term upgrades. The B.O.W.L. licensing system provides a way to preorder any number of 7-day licenses and activate them whenever needed without having to place individual orders. No credit is given for the purchase of 7-day term licenses towards the purchase of a perpetual license.

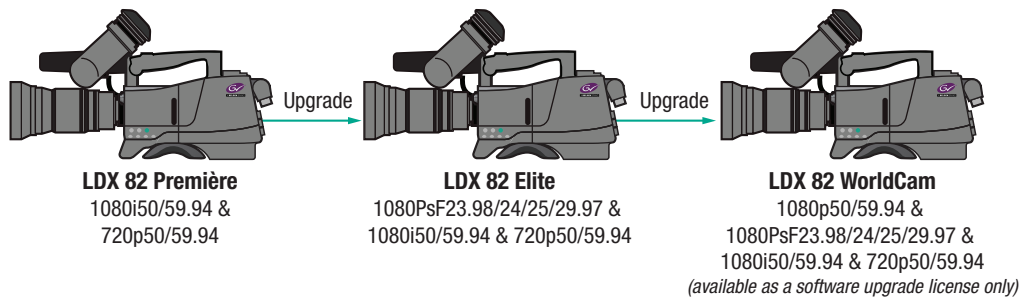

Note: Multiple licenses may be purchased to upgrade a camera more than one level, on a perpetual or 7-day term basis.

	LDX PREMIÈRE SERIES can be upgraded to LDX 82 Elite*	LDX ELITE SERIES can be upgraded to LDX 82 WorldCam	LDX WorldCam SERIES (available as a software upgrade license only)
Imager	Next-generation Xensium-FT		
Sensitivity @ 2000 lux	F12 typical (all 50 Hz modes) / F11 typical (all 59.94 Hz modes)		
S/N ratio	62 dB (typical)		
Increased sensitivity	✓	✓	✓
Improved digital noise reduction	✓	✓	✓
TrueTexture: texture is preserved throughout all processing parameters	✓	✓	✓
Switchable video formats: 1080i50/59.94 and 720p50/59.94	✓		
Switchable video formats: 1080PsF23.98/24/25/29.97 (artistic), 1080i50/59.94, 720p50/59.94		✓	
Switchable video formats: 1080p50/59.94 (3G), 1080PsF23.98/24/25/29.97 (artistic), 1080i50/59.94, 720p50/59.94			✓
Effortless 1080p50/59.94 acquisition with no increased lighting requirement			✓
Support of BT.2020 wide color gamut	✓	✓	✓
Native HDR support in SMPTE ST 2084, HLG and S-Log3	Optional	Optional	Optional
Suitability for 3D productions		✓	✓
ArtTouch: smart coupling of video control functions	✓	✓	✓
Perfect picture matching across the complete LDX Series as well as the LDK installed base	✓	✓	✓
Ergonomically designed camera head with easy access to control buttons, including the new PickMe button	✓	✓	✓
CLASS: basic electronic lens error correction	✓		
CLASS: advanced electronic lens error correction		✓	✓
Standard secondary color corrector (two-color)	✓		
Advanced secondary color corrector (up to six sets for color hue, saturation and luminance adjustment)		✓	✓
Fully compatible with 3G fiber/triax transmission systems	✓	✓	✓
Fully compatible with XF fiber transmission systems	✓	✓	✓
Compatible with C2IP control systems and Reflex SuperXpander	✓	✓	✓
Second motorized optical filter wheel with 4P-star and soft focus		✓	✓
Dynamic aperture correction	✓	✓	✓
Dynamic contour equalizer		✓	✓
Power curve gamma control		✓	✓
Depth of field indicator		✓	✓
Side grip		✓	✓

* Licenses may be purchased to upgrade more than one level (e.g., LDX 82 Première to LDX 82 WorldCam), on a perpetual or 7-day term basis.

The B.O.W.L. (bunch of weekly licenses) licensing option allows users to preorder any number of 7-day licenses and activate them as needed.

The license for HDR providing true 15 F-stop operation in all formats for all LDX 82 Series camera heads is available on a 7-day or perpetual term basis.

3G Transmission

The **XCU WorldCam** for all LDX Series cameras and many LDK Series camera heads is part of Grass Valley's 3G Transmission series. XCU is a follow up to the world's first transmission system that supports all HD video formats (720p, 1080i and 1080p) with full performance over triax and fiber cables between the camera heads

and the base station. The rack-mounted XCU cradle makes the XCU chassis easily removable.



Patented

The Grass Valley XCU WorldCam base stations are members of the 3G Transmission series and work with all 3G transmission adapters to form a 3G-capable camera transmission solution for all LDX Series cameras and many LDK Series camera heads (see specifications). These third-generation transmission solutions from Grass Valley are no-compromise, fully featured solutions that can cope with the broadcast requirements of today and tomorrow.

The 3G transmission systems are heavy-duty, high-quality, multi-standard transmission systems with new and specially developed advanced technologies. The XCU WorldCam is fully 3G and 3D ready, and support current 1080i50/59.94, 720p50/59.94 and 1080PsF23.98/24/25/29.97 formats as well as 1080p50/59.94 transmission from the LDX WorldCam.

The Grass Valley 3G Triax system works perfectly with triax cables that are pre-wired in venues as well as users' current cable stock, eliminating the need for expensive new cabling. Compared to conventional HD triax, the maximum cable length has increased by 25% to 1,500m (4,921 feet) while still offering the same robustness and reliability that triax is known for.

The Grass Valley 3G Fiber system works perfectly with SMPTE hybrid fiber cables and offers an increased maximum cable length and the capability to support even the extended bandwidth requirements of a SuperSloMotion camera system with up to 3X HD operation. The maximum cable length including power can be up to 3,000m (9,842 feet) and, when powering the camera locally, a maximum cable length of more than 40,000m (24.85 miles) can be achieved.

Just as the dockable concept of the LDX camera system permits easy exchange of the transmission adapters with the camera heads, a range of wireless adapter kits have been developed and introduced by several dedicated RF technology providers. By supporting a wide range of highly integrated wireless transmission solutions with different feature sets and functionality, LDX camera systems can satisfy diverse user requirements.

Unique Cradle Concept

XCU base stations take flexibility even further with their unique cradle connectivity. The XCU cradle (XCUs each come with one cradle — additional cradles are available separately) can be pre-mounted and pre-wired in the rack while the XCU base stations can easily slide in and out whenever needed, making a secure mechanical and electrical connection.

Unique benefits are:

- Significant time saving while reconfiguring OB trucks
- Preventing cabling mistakes
- Reducing vehicle or facility costs
- Takes minimal rack space: a compact design of only 2 RU

All of these features combined deliver flexibility between OB trucks and cut the shipping/transport costs of moving XCUs between locations.

XCU base stations offer extended connectivity. The XCU WorldCam is equipped with eight HD outputs, six of which are single-link HD-SDI outputs (1.5 Gb/3 Gb switchable) with the remaining two being 1.5 Gb HD-SDI outputs — which automatically converts the signal to 1080i or 720p when the camera head is delivering 1080p.

Audio connectivity offers great versatility with two analog outputs and two AES/EBU pair outputs (2x2 channels) which are also embedded in the HD-SDI outputs.

XCU CAMERA TRANSMISSION KEY FEATURES

- Full support for all HD formats: 720p/1080i/1080p/1080PsF
- Two versions available:
 - Triax only
 - Hybrid fiber only
- Unique cradle connectivity to support dockable XCU (eXchangeable control unit)
- Built-in memory in XCU Cradle for production-set storage
- Video outputs: 6x 3G and 2x 1.5G or 8x 1.5G video outputs
- Extensive (analog/digital) audio connectivity
- Embedded audio
- 3x selectable return inputs: 3G, HD, or SD
- Universal 3G power supply
- Compact (2 RU), robust base station

XCU CAMERA TRANSMISSION SPECIFICATIONS

Video

720p: 50/59.94 Hz
 1080i: 50/59.94 Hz
 1080PsF (LDX Elite or WorldCam required): 23.98/24/25/29.97 Hz
 1080p (LDX WorldCam required): 50/59.94 Hz

Compatible Cameras

All LDX Series cameras running HD formats

General (incl. cradle)

Dimensions XCU + cradle (HxWxL, approx.): 438 x 88 x 510 mm (19" rack, 2 RU) (17.2 x 3.5 x 20.1 in.)
 Operating temperature: 0 to +45° C (+32 to +113° F)
 Storage temperature: -20 to +70° C (-4 to +158° F)
 Operation humidity: Max. 90% (non-condensing)
 Shock resistance: Max. 10G (transport, Max. 2G (operating)
 Altitude: Max. 15,420m (50,000 ft.)
 Weight XCU + cradle: 11.8-12.2 kg (26.0-26.9 lbs.) (depending on version) full-option equipped
 Weight XCU: 7.3-7.7 kg (16.1-16.9 lbs.) (depending on version) full-option equipped
 Power requirement: AC 100V/240V, 47 to 63 Hz
 Power connector: IEC type, 3-pin male
 Power consumption: Total power (Cam + XCU) 450W max.

Connectors

Teleprompter in: BNC 1x (loop-through output), (C)VBS, 1.0 Vp-p, 75Ω
 Reference in: 1x (loop-through output), 1.0 Vp-p, 75Ω HD tri-level sync or SD black-burst
 HD-SDI out: BNC 6x 0.8 Vp-p, 75Ω, SMPTE ST 292, 1080i/720p at 50/59.94 Hz or BNC 6x 0.8 Vp-p, 75Ω, SMPTE ST 425A, 425B, 1080p at 50/59.94 Hz
 HD-SDI out (live/effect): BNC 2x 0.8 Vp-p, 75Ω, SMPTE ST 292, 1080i/720p at 50/59.94 Hz
 HD-SDI monitoring out: BNC 1x 0.8 Vp-p, 75Ω, SMPTE ST 292, 1080i/720p at 50/59.94 Hz
 SD-SDI out: BNC 2x 0.8 Vp-p, 75Ω, SMPTE ST 259 ITU-R, BT.601
 SD-SDI monitoring out: BNC 1x 0.8 Vp-p, 75Ω, SMPTE ST 259 ITU-R, BT.601
 Composite Video monitoring output: BNC 1x 1.0 Vp-p, 75Ω (CVBS text with video, for viewing purposes)
 Signaling in/out: D-sub 15-pin, male; preview, green tally (call), dry contact; yellow tally (iso), dry contact; red tally (on air), dry contact; remote audio level control (22-64 dB), DC
 Auxiliary in/out: D-sub 9-pin, female; private data in/out; 100 kb TTL (RS-232)
 Control data: RJ-45 connector for C2IP (camera control)
 Control data: RJ-45 connector for Ethernet (future use)
 Fiber (Hybrid) executions: Lemo Hybrid fiber connector acc. SMPTE ST 304 (other fiber connectors on request)
 Triax executions: Fischer, other Triax connectors on request

External video in: HD-SDI (1.5 Gb/3.0 Gb) or SD-SDI in 1, (loop-through output), 0.8 Vp-p, 75Ω/HD-SDI (1.5 Gb/3.0 Gb) or SD-SDI in 2, 0.8 Vp-p, 75Ω/HD-SDI (1.5 Gb/3.0 Gb) or SD-SDI in 3, 0.8 Vp-p, 75Ω
 2-ch. audio: Audio out, XLR-3 2x ; 0/+6 dBu (±1.5 dB, max. 18 dBu, 600Ω, gain max. 70 dB)
 Frequency response: 40 Hz to 15 Hz, (+1/-3 dB, 1 kHz, -10 dBu output level)
 Distortion: Less than 0.5% (100 Hz/1 kHz, +6 dBu out, 600Ω)
 S/N ratio: 58 dB (unweighted RMS)
 AES-EBU 1+2: BNC 75Ω, Dig audio output Audio 1 and 2
 AES-EBU 3+4: BNC 75Ω, Dig audio output Audio 3 and 4
 Intercom in/out (2/4-wire intercom): D-sub 15-pin, female (program in, production in/out, engineering in/out), in: 0 or 6 dBu; out: 0 or 6 dBu (±2 dB, max. 12 dBu)
 Frequency response: 150 Hz to 6 kHz (1 kHz, -10 dBu output level)
 Distortion: Less than 2% (1 kHz, +12 dBu level)



Camera Adapters

The dockable implementation of all LDX Series cameras provides fast and easy configuration of the camera transmission system. Depending on the type of camera transmission system to be used, there is a choice of two different transmission adapters. For wireless applications, there are several different highly integrated transmission solutions available from third-party suppliers.

The latest generation of 3G Triax and 3G Fiber transmission adapters offers several improvements for users in different areas such as:

- Improved operation with crane/robotic heads
- Improved maximum power from the DC output to directly power various teleprompters
- Improved user interface area with illuminated buttons and indicator LEDs for easy control during installation and operation
- Approximately 1 kg (2.2 lbs.) lower weight, making the total camera system weight to be one of the lowest available
- More than 25% reduction in power consumption, which translates into a much lower operating temperature as well

Combining a dockable camera head, different transmission adapters, XCU dockable base stations and a wide variety of different 3G field converters, provides the means for all LDX Series cameras to deliver the ultimate flexibility for even the most demanding of applications.



SPECIFICATIONS

LDX 3G Triax Adapter (LDX 5640)

Power requirements: Triax powered or 12 VDC (local)

Operating temperatures: -20 to +45°C (-4 to +113°F)

Storage temperatures: -25 to +70°C (-13 to +158°F)

Weight (approx.): 2.1 kg (4.6 lbs.)

Dimensions (L x W x H): 222.1 x 132.7 x 212.1 mm (8.7 x 5.2 x 8.4 in.) without handgrip

Triax connection: Swivel Triax connector (Fischer, other connectors available on request)

Triax cable length: 1,500m (5,000 ft.) max. with 14 mm (0.55") cable (specified for Draka Triax cable)

Analog VF output or AES/EBU audio input: BNC connector 1.0 Vp-p; 75Ω

VF output or main output: BNC connector 1.0 Vp-p; 75Ω

Reference input: BNC connector 0.6 Vp-p; 75Ω HD tri-level reference signal

EXT video output connector: BNC connector 1.0 Vp-p; 75Ω

Teleprompter output or analog ref input: BNC connector 1.0 Vp-p; 75Ω

Auxiliary: 20-pin data connector with Tracker intercom, remote control lines and studio signaling

Rear microphone inputs: 2x XLR-3, balanced, +48V phantom power

Intercom: XLR-5 with 3 channels (engineering, production and program)

DC power input: 12V/7A max. (11 to 17V), XLR-4 male

Script light power output: 12V (100 mA), 4-pin Hirose

DC power output: 12V/4A, XLR-4 female

LDX 3G Fiber Adapter (LDX 5650)

Power requirements: Hybrid fiber powered or 12 VDC (local)

Operating temperatures: -20 to +45°C (-4 to +113°F)

Storage temperatures: -25 to +70°C (-13 to +158°F)

Weight (approx.): 2.1 kg (4.6 lbs.)

Dimensions (L x W x H): 222.1 x 132.7 x 212.1 mm (8.7 x 5.2 x 8.4 in.) without handgrip

Fiber connector: Swivel hybrid fiber connector SMPTE ST 304 Lemo (other connectors available on request)

Cable length: 3,000 m (10,000 ft.) max. using SMPTE ST 311 hybrid fiber cable

Analog VF output or AES/EBU audio input: BNC connector 1.0 Vp-p; 75Ω

VF output or main output: BNC connector 1.0 Vp-p; 75Ω

Reference input: BNC connector 0.6 Vp-p; 75Ω HD tri-level reference signal

EXT video output connector: BNC connector 1.0 Vp-p; 75Ω

Teleprompter output or analog ref input: BNC connector 1.0 Vp-p; 75Ω

Auxiliary: 20-pin data connector with Tracker intercom, remote control lines and studio signaling

Rear microphone inputs: 2x XLR-3, balanced, +48V phantom power

Intercom: XLR-5 with 3 channels (engineering, production and program)

DC power input: 12V/7A max. (11 to 17V), XLR-4 male

Script light power output: 12V (100 mA), 4-pin Hirose

DC power output: 12V/4A, XLR-4 female



3G Fiber-Based Systems (LDX 80/82/86/86^N Series camera heads are fully compatible with 3G transmission systems.)

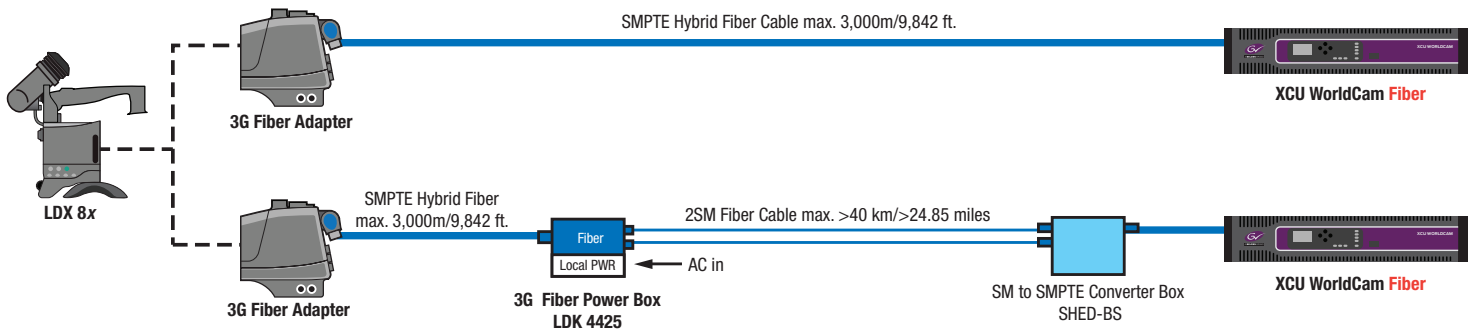

3G Triax-Based Systems (LDX 80/82/86/86^N Series camera heads are fully compatible with 3G transmission systems.)

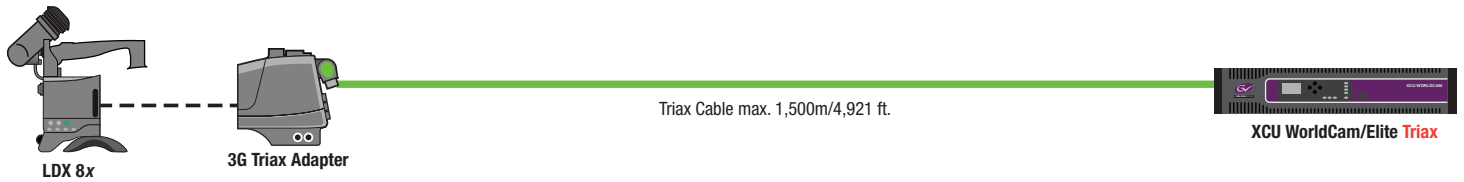

LDX C82 Compact Series



An extension to the revolutionary LDX 82 Series of cameras — built for business flexibility and operational excellence — with superior imaging, processing and performance. The

LDX C82 Compact Series supports advanced 1080p formats including wide color gamut and optional HDR operation.

There are many applications for a compact and cost-efficient addition, or alternative, to system cameras. However, the expectation is that small form-factor cameras must perform just as well as the larger form factor cameras.

The Grass Valley LDX C82 Compact Series provides the same image performance and all of the control features of the LDX 82 Series of high-quality broadcast system camera in a smaller mechanical package. This produces the same level of quality in areas and from angles that can be very space constrained.

The LDX C82 Compact Series cameras are the perfect companions to the LDX 82 Series cameras that are used extensively for live production in OB vans and studios. They also bring a new level of image performance and business flexibility for all applications where cameras with a compact form factor are required. This can be for various production requirements, such as compact cameras mounted on compact remote heads, on rail systems, as Spidercams, or in combination with gyroscopic stabilizing systems. The requirements can also be for cost/efficiency reasons where smaller cameras might be used instead of larger and more expensive system cameras. These applications include compact cameras mounted on robotic heads in studios, for fixed-mounted camera positions, on Steadicam systems, on camera cranes, or on 3D rigs.

In these applications, some of the typical features of a system camera — such as the intercom connection, the hand grip and shoulder pad, or the viewfinder mount — are not needed. On the other hand, a more compact and lightweight camera body which is also easier to mount provides for a better integration for these applications.

All these different applications can be found at production companies, broadcasters, houses of worship, education and many more.

Designed for the Application

In addition to establishing a new standard for compact image acquisition, the design of the LDX C82 Compact Series focuses strongly on the specific requirements for cameras with a smaller form factor. All of the typical interfaces which are required are available directly on the camera head. Additionally, LDX C82 Compact Series offers several new interfaces which include a USB connection for the management of GV-eLicenses, firmware upgrades and scene file storage. The camera also offers an HDMI interface for connecting any HD display with an HDMI or DVI interface to be used as

a camera viewfinder or monitoring display. The user-friendliness of LDX C82 Compact Series cameras has been further improved by using a streamlined menu structure that allows operators to access commonly used functions more quickly.

Engineered for the Bottom Line

LDX C82 Compact WorldCam provides 1080i and 720p as well as 1080p production — with the same sensitivity as shooting 1080i.

By supporting BT.2020 wide color gamut, the LDX C82 Compact Series offers outstanding color reproduction, addressing the requirements for future-proofed advanced HD formats.

Via the XDR GV-eLicense, HDR operation with a dynamic range of at least 15 F-stops can be provided. Both HDR OETFs with SMPTE ST 2084, as well as HLG, are natively produced inside the camera head avoiding any lossy conversion between different non-standardized transfer functions.

With the LDX C82 Compact Series, Grass Valley has paid particular attention to the ongoing costs of operation. LDX C82 Compact Series cameras are fully integrated with our Ethernet-based C2IP camera control system, which provides a powerful link to remote production capabilities. This smart feature provides full remote control over all camera controls via any IP-link and includes DigiTally — an all-digital remote tally protocol over IP.

The LDX C82 Compact Series offers the flexibility to adjust capital expenses and operating expenses to match a variety of business goals and factors. LDX C82 Compact Series is about more than just pretty pictures: LDX C82 Compact Series is built to face the realities of live production and broadcast — today and tomorrow.

With the unique LDX GV-eLicense program, users now have the ultimate flexibility in format support and feature set availability. With GV-eLicense, LDX users have the choice of upgrading their cameras in two different ways. A perpetual upgrade license provides an upgrade from any lower model of the range to the next higher model of the range. With a 7-day term upgrade license, the same flexibility is available, but for a lower cost. Licenses may be purchased to upgrade cameras or to extend 7-day term upgrade licenses. To enhance convenience and user flexibility, the B.O.W.L licensing system offers users a way to preorder any number of 7-day licenses and activate them for any camera whenever needed with a secured web-based activation tool. The ability to upgrade to the next level camera, on a perpetual or 7-day term basis, provides the ultimate in production flexibility.

	LDX Elite <small>COMPACT</small> can be upgraded to LDX C82 Compact WorldCam	LDX WorldCam <small>COMPACT</small> (available as a software upgrade license only)
Imager	Next-generation Xensium-FT	
Sensitivity @ 2000 lux	F12 typical (all 50 Hz modes) / F11 typical (all 59.94 Hz modes)	
S/N ratio	62 dB (typical)	62 dB (typical)
Increased sensitivity	✓	✓
Improved digital noise reduction	✓	✓
TrueTexture: texture is preserved throughout all processing parameters	✓	✓
Switchable video formats: 1080i50/59.94 and 720p50/59.94		
Switchable video formats: 1080PsF23.98/24/25/29.97 (artistic), 1080i50/59.94, 720p50/59.94	✓	
Switchable video formats: 1080p50/59.94 (3G), 1080PsF23.98/24/25/29.97 (artistic), 1080i50/59.94, 720p50/59.94		✓
Optional RGB 4:4:4 1080i outputs	✓	✓
Effortless 1080p50/59.94 acquisition with no increased lighting requirement		✓
Suitability for 3D productions	✓	✓
Support of BT.2020 wide color gamut	✓	✓
Native HDR support using SMPTE ST 2084, HLG and S-Log3	Optional	Optional
ArtTouch: smart coupling of video control functions	✓	✓
Perfect picture matching across the complete LDX Series as well as the LDK installed base	✓	✓
Camera head with easy access to control buttons, including the new PickMe button	✓	✓
CLASS: advanced electronic lens error correction	✓	✓
Standard secondary color corrector (two-color)		
Advanced secondary color corrector (up to six sets for color hue, saturation and luminance adjustment)	✓	✓
Compatible with C2IP control systems	✓	✓
Second motorized optical filter wheel with 4P-star and soft focus	✓	✓
Dynamic aperture correction	✓	✓
Dynamic contour equalizer	✓	✓
Power curve gamma control	✓	✓
Depth of field indicator	✓	✓

*Multiple licenses may be purchased to upgrade on a perpetual or 7-day term basis.

The B.O.W.L. (bunch of weekly licenses) licensing option allows users to preorder any number of 7-day licenses and activate them as needed.

LDX C82 COMPACT SERIES SPECIFICATIONS

General

Power: Approx. 30W (typical, depends on operational mode)
Temperature range: -20° to +45°C (-4° to 113°F) (operating)
Water protection: Compliant to IPX0
Weight: approx. 2.5 kg (5.1 lbs.)
Dimensions (approx.):
 Width: 113 mm (4.45 in.)
 Depth: 156 mm (6.14 in.)
 Height: 140 mm (5.51 in.)

Camera

Pick-up device: 3 x 2/3" Xensium-FT CMOS
Picture elements: 1920x1080
Smear: no vertical smear
Shutter: no mechanical shutter
Optical system: F1.4 prism
Lens mount: 2/3" Bayonet type
Optical filter wheels: 2x motorized wheels
Optical filters on first wheel: clear, 1/4 ND, 1/16 ND, 1/64 ND
Optical filters on second wheel: clear, 4P-star, soft focus
Electronic color correction: 3200°K, 5600°K, 7500°K, FL, 2 AWB presets, Var, continuous auto white
Exposure: electronic exposure down to 1/1000 sec

Video Modes

LDX C82 Compact WorldCam switchable formats:
 1080p50/59.94, 1080PsF23.98/24/25/29.97, 1080i50/59.94 & 720p50/59.94

Sensitivity at 2000 lux:

F12.0 (1080i50, 720p50 and 1080p50)
 F11.0 (1080i59.94, 720p59.94 and 1080p59.94)
 F18.0 (1080PsF23.98/24/25)
 F16.0 (1080PsF29.97)

S/N ratio: 62 dB typical

Aspect ratio: 16:9

Modulation depth: 60% (typical) at 800 TV lines (27 MHz) in 1080i50/59.94 & 720p50/59.94 modes

Digital resolution: Floating point A/D conversion with 16-bit performance and with 34-bit processing in RGB

Horizontal resolution: >1,000 TV lines

Gain selection: -6 dB to +18 dB in 3 dB steps (user-definable presets) or continuous master gain

Connectivity

Lens iris connector: 12-pin female Hirose (front)
Lens zoom/focus connector: 12-pin male Hirose (front)
USB: GV-eLicense, scene files, service
HDMI: viewing
Ethernet RJ-45: C2IP camera control
Tally control/RS-232/RS-422/Private data: D-connector – 15-pin
4x HD/3G SDI outputs: BNC 0.8 Vp-p, 75Ω, SMPTE ST 292, 424/425
HD-SDI monitoring video output: BNC 0.8 Vp-p, 75Ω, SMPTE ST 292, 424/425
Genlock input: BNC CVBS/BB/tri-level
Power input: XLR-4 male (10.5-17 VDC)

Control Buttons and LED Indications

PickMe
 Menu control: menu select, rotary control
 Color bar button
 Info button
 Filter wheel selection
 Standard file recall
 2 user assignable buttons
 2 digit display: Power on, camera number
 Tally LEDs: On Air; ISO; Call

Notes:

For the LDX Compact C82 WorldCam, a perpetual GV-eLicense for 10-bit RGB 4:4:4 outputs in 1080i is available.



GV-eLicense PROGRAM

Perpetual license: Perpetual upgrade to the next camera in the range

7-day term license: 7-day (weekly) term upgrade to the next camera in the range

The unique GV-eLicense program from Grass Valley offers users the ultimate flexibility to initially invest in a camera that offers a minimum feature set and upgrade to a more advanced feature set when needed. It is a future-proof concept which helps to secure the investment in new technology and shifts CAPEX to OPEX.

HDR weekly or perpetual license: 7-day or perpetual licenses for the addition of true 15 F-stop HDR operation in all single speed formats for all LDX C82 Compact Series camera heads is available.

Multiple licenses may be purchased to upgrade cameras by more than one level (e.g., LDX C82 Compact Première to LDX C82 Compact WorldCam). Multiple 7-day term licenses may be purchased for extended 7-day term upgrades. The B.O.W.L. licensing system provides a way to preorder any number of 7-day licenses and activate them whenever needed without having to place individual orders. No credit is given for the purchase of 7-day term licenses towards the purchase of a perpetual license.

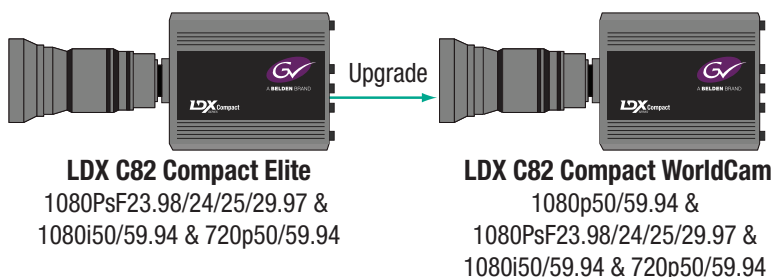

Camera Control Systems

Creative Grading

While Grass Valley continues to support the OCP 400, with Grass Valley's new Creative Grading the Focus and LDX camera series just unleashed their full potential. Creative Grading is a new camera shading control panel and tablet application that redefines the human interface and puts the user in full control of the creative power that lives inside Grass Valley cameras.

Using either or both a tablet and an intensively-tested new control panel, Creative Grading transforms camera shading from what was numeric on/off thinking to a holistic view of organic curves and color shaping. For ease in visualization, the larger UI of the tablet application provides a graphical representation of the impact of parameter changes. Artistic decision making is much simpler and faster as shaders can see how a single change affects related sets of parameters in a system-wide view of how the on-screen image will be modified. This keeps shaders in full control, regardless of the situation and provides the camera operator with the most optimal working conditions for the task.

For additional information on Creative Grading, please see the [Creative Grading Technical Brief](#).

Software Development Kit (SDK)

For integration of applications developed by a third-party, a dedicated Software Development Kit is available upon request at www.grassvalley.com/ad/connect_gateway_sdk.



KEY FEATURES

- Ethernet-based camera control system
 - Supports 10/100Base-T networks
 - Uses C2IP, a TCP/IP-based protocol
 - Uses off-the-shelf standard network infrastructure
- Supports all Grass Valley digital LDX cameras
- Camera control:
 - Multicamera control supports up to 99 cameras
 - Multipoint control supports multiple control points per camera
- OCP 400 operational control panel:
 - Features capabilities found in conventional master control panels
 - Comfortable, very compact (82 mm wide) design
 - Intuitive interface
 - Hard-style buttons
- CGP 500 – Creative Grading Panel:
 - Can be a direct replacement for OCP 400
 - When paired with CCS-ONE and CGA provides many more assignable options for direct control
 - Joystick simultaneously enables full control of four controls of choice, such as Iris, Master Black, Variable Gain and Variable Color Temperature
 - Assignable knobs provide direct access for Gamma Level, ND Filter, Detail Level and Saturation or any other set of controls that are required for the task at hand
- CCS-ONE – Cameras Control Server:
 - Creative Grading replacement for the Master Control functionality of the MCP 450
 - Hosts up to 99 cameras
 - Supports networking and security tools for distributed production
- Creative Grading App:
 - Intuitive, graphic representation of parameter controls
 - Tablet-driven interface can be used without CGP 500 for lightweight distributed shading
- Creative Grading:
 - Control with panel and (optional) tablet
 - Adjust camera parameters as logical groupings
 - Seamlessly shift a camera from one look to the next with a single hand — even when on-air
 - Easily experiment with different shading looks
 - Share the same look across multiple cameras
 - Control multiple cameras from the same panel
 - Enable shading at any skill level

RefleX SuperXpander

The **RefleX SuperXpander** is the perfect match for LDX cameras using the unique 3G Transmission system or XF Fiber Transmission system and turns a comfortable shoulder camera quickly and easily into a full-featured studio camera.

Grass Valley broadcast products offer production professionals the most comprehensive multiformat solutions for acquisition, production, storage and playback, as well as a strong foundation for centralized, proactive status and activity monitoring. The Grass Valley RefleX SuperXpander is such a solution. Compatible with the latest 3G Transmission family and the XF Fiber Transmission system, it supports box-type lenses, teleprompters and high-resolution viewfinders.

For sports and events coverage, the use of large zoom lenses is a common requirement. The RefleX SuperXpander acts as a large lens adapter, rapidly converting a portable camera into a full-featured studio camera.

The lightweight RefleX SuperXpander provides secure mounting and balancing for the largest prompter monitors. For increased simplicity, the camera can remain mounted inside the RefleX SuperXpander housing for transport, saving rigging time and precious space, while ensuring that the camera is aligned and ready to go immediately. Alternatively, the camera can be mounted or released from the housing quickly so it can be switched between pedestal, box lens and handheld applications working with an ENG style lens — even during a live program.

The RefleX SuperXpander can be used with all Grass Valley viewfinders, providing an unprecedented degree of freedom. The unique design of the RefleX SuperXpander system puts even a large viewfinder close to the optical axis



of the camera, making camera movements and positioning more intuitive for the operator to ensure that the shot is right every time.

The new hot shoe connector between the camera and the RefleX SuperXpander provides all power and signal connectivity — making it quick, convenient and reliable, with no need for extra cabling. The hot shoe connector also makes the RefleX SuperXpander transmission system-agnostic — 3G Fiber, 3G Triax and XF Fiber camera systems can be used with the same SuperXpander without the need of switching modules.

For operator convenience, the RefleX SuperXpander is equipped with a functional control panel placed at the rear of the camera. All camera functions can be selected through this panel with its intuitive button layout, with three of the buttons assignable by the operator. These buttons have a sophisticated backlight to improve readability in all lighting conditions and to indicate the status of the buttons.

Two utility power connectors are provided to drive external equipment. Each connector (XLR-4 female) is rated at 13.8V/8 amps. or 120W maximum (combined).

KEY FEATURES

- Supports LDX cameras
- Transmission system-agnostic
- Supports 3G Transmission and XF Fiber Transmission products
- Improved rapid mounting of camera and box lens
- Direct connection of viewfinder to the camera
- Rock-solid configuration for all sizes of large lenses
- Convenient camera control panel at the rear
- Three assignable control buttons
- Mounting and balancing available for all prompter monitors
- Two fixed utility output connectors: 13.8V@8A each or 120W max. (combined)

SPECIFICATIONS

Dimensions (L x W x H): 526 x 287 x 347 mm (20.7 x 11.3 x 13.7 in.)

Weight (approx.): 8.5 kg (18.7 lbs.)

Operating temperatures: -20°C to +45°C (-4°F to +113°F)

Storage temperatures: -20°C to +60°C (-4°F to +140°F)

Power supply: supplied by the base station

Power consumption: 250 VA max. fully equipped (supplied by the base station)

Utility power outputs: 2x 13.8 VDC XLR-4 female connector, 120 W max. (combined)

Lens interface: 36-pin Centronics female connector



RefleX SuperXpander – Fast and Easy Docking

EyeCatcher EC 200 Viewfinder



The eyes are the most important tools used during a production. Every detail of a shot is important—and the operator must be able to rely on what they are seeing. The **EyeCatcher EC 200** color ocular viewfinder provides users with the confidence to know what they see is what is also being seen in the control room and by viewers.

The Grass Valley EyeCatcher EC 200 is a high performance color LCD ocular viewfinder for the LDX 8x Series camera heads. It is part of a full line of state-of-the-art color viewfinders and is very feature-rich with an intuitive user interface. The EyeCatcher viewfinder also has a stylish look and compact design.

EyeCatcher EC 200 offers the best possible image performance, high-speed response time, QHD resolution of 960x540 pixels and a diagonal size of 5.1 cm (2.0 in.). The controls are easy and flexible, similar to the Grass Valley 7-inch and 7.4-inch color LCD viewfinders. It comes with two (task) assignable user buttons and a -3 to +1 diopter compensation range.

KEY FEATURES

- Stylish look and compact design
- Fully compatible with all LDX cameras
- Offers the best possible image performance:
 - High resolution
 - Fast response
- High brightness and contrast ratio
- Easy and flexible to use
- Brightness, contrast and peaking adjustment with rotary controls
- Color/monochrome picture switchable
- Tally on-low-off switch
- Operator-only tally indicator
- Underscan mode for full picture visibility off shoulder
- 2 (task) assignable buttons
- Diopter compensation range

SPECIFICATIONS

Connectors

Camera connector: 20-pin Hirose

Controls

2 assignable user buttons
Brightness rotary control
Contrast rotary control
Combined menu/Peaking rotary control

Indicators

LED indicators inside:

ISO (yellow)
On-air (red)
Call (green)
LED indicators front:
1x on-air (red) adjustable

General

Power consumption: 3.9W (supplied by camera head)
Operating temperature: -20°C to +45°C (-4°F to 113°F)
Storage temperature: -25°C to +70°C (-13°F to 158°F)
Weight: 900 grams (2.0 lbs.)

LCD

Diagonal size: 51 mm (2.0")
Resolution: 960x540 pixels (QHD)
Response rate: 16 ms

Performance

Color depth: 16.7 million colors
8-bit color
Brightness: 250 Cd/m²
Contrast ratio: 200:1
Color temperature: 6500K (adjustable)
Pixel pitch: 0.047 mm x 0.047 mm
Supported formats: All current HD formats
Input signals: Y,Pr,Pb

The viewfinder's LCD panel is manufactured using high-precision technology that yields a pixel response of 99.99% or higher.

VF 700-H Viewfinder

The **VF 700-H** viewfinder for the Grass Valley LDX cameras has native HD resolution in addition to high brightness and contrast as well as fast refresh rate, making it ideal for both indoor and outdoor use.

The VF 700-H is a compact, high-quality, flat panel color viewfinder designed to work with Grass Valley LDX system cameras. The stylish design allows for direct mounting to the mini wedge plate of the camera head in both EFP and SuperXpander configurations.

With native HD 1920x1080 pixels, panel focusing becomes easy. In combination with high brightness and contrast, and a fast display refresh rate, the VF 700-H is the perfect color viewfinder for both indoor and outdoor applications.

The VF 700-H color viewfinder has an intuitive menu structure which not only allows for settings of the viewfinder, but can also be used to call up the camera system menu via the viewfinder controls.

Three rotary controls, for contrast, brightness and peaking settings, are easily accessible at the front panel. In addition, three user assignable push buttons are located at the front bezel of the viewfinder.



The color temperature of the display can be adjusted to match the operator's personal preference without any affect on the main video signal, allowing the operator to match the display color temperature with the color temperature of the scene.

KEY FEATURES

- 7-inch IPS LCD panel with LED backlight
- Bonded LCD screen for reduced reflections
- High brightness and contrast
- Full HD resolution with 1920x1080 pixels
- Adjustable box and markers
- Camera menu access
- Supports all current HD formats
- Supports 4K/UHD operation
- Fast response time
- EFP and SuperXpander use
- Easy accessible front controls
- Robust magnesium housing
- Compatible with LDX 8x Series camera systems

SPECIFICATIONS

Connectors

Camera connector: 20-pin Hirose

Controls

Menu button
3 assignable user buttons
Brightness rotary control
Contrast rotary control
Peaking rotary control

Indicators

LED indicators front:

ISO (yellow)
On-air (red)
Call (green)

LED indicators back:

2x on-air (left/right) adjustable

General

Power consumption: 12W (supplied by camera head)
Operating temperature: -20°C to +45°C (-4°F to 113°F)
Storage temperature: -25°C to +70°C (-13°F to 158°F)
Weight: 1.8 kg (3.97 lbs.)

LCD*

Diagonal size: 177.8 mm (7 in.)
Active video: 16:9 1920 (H) x 1080 (V) pixel
Viewing angle: 170° horizontal, 170° vertical
Response rate: 23 ms typical

Performance

Color depth: 16.7 million colors
8-bit color
Brightness: 700 Cd/m²
Contrast ratio: 800:1
Color temperature: 6500K (adjustable)
Pixel pitch: 0.081 x 0.081 mm
Supported formats: All current HD formats
Input signals: Y,Pr,Pb

Supplied Accessories

Complete mounting kit
Short sunhood
Cabling
User's guide

* The viewfinder's LCD panel is manufactured using high-precision technology that yields a pixel response of 99.99% or higher.

VFR 600-H Viewfinder



The **VFR 600-H** viewfinder for the Grass Valley LDX cameras is a very economic solution for HD focusing, mainly targeted for less demanding studio applications.

The VFR 600-H is a compact, lightweight and economic, flat panel color viewfinder designed to work with Grass Valley LDX system cameras. The stylish design allows for direct mounting to the mini wedge plate of the camera head in both EFP and SuperXpander configurations.

With 1280x800 pixels panel resolution, focusing becomes easy in all HD applications. In combination with high brightness and contrast, the VFR 600-H is a good color viewfinder for both indoor and outdoor applications.

The VFR 600-H color viewfinder has a menu structure which allows for settings of the viewfinder.

Four rotary controls, for contrast, brightness, saturation and peaking settings, are easily accessible at the front panel. In addition, five user assignable push buttons are located at the front bezel of the viewfinder.

The color temperature of the display can be adjusted to match the operator's personal preference without any affect on the main video signal, allowing the operator to match the display color temperature with the color temperature of the scene.

KEY FEATURES

- 7-inch IPS LCD panel
- Good brightness and contrast
- HD resolution with 1280x800 pixels
- Adjustable box
- Supports all current HD formats
- Pixel-to-pixel mode selectable
- Supports 4K/UHD operation
- EFP and SuperXpander use
- Easy accessible front controls
- Compatible with LDX 8x Series camera heads

SPECIFICATIONS

Connectors

Camera connector: 20-pin Hirose

Controls

Menu button
5 assignable user buttons
Brightness rotary control
Contrast rotary control
Peaking rotary control
Saturation rotary control

Indicators

LED indicators front:

On-air (red)

LED indicators back:

On-air

General

Power consumption: 11W (supplied by camera head)

Operating temperature: -10°C to +40°C (14°F to 104°F)

Weight: 1.5 kg (3.3 lbs.)

LCD*

Diagonal size: 177.8 mm (7 in.)

Active video: 16:9 1280 (H) x 800 (V) pixel

Viewing angle: 178° horizontal, 178° vertical

Performance

Color depth: 16.7 million colors

8-bit color

Brightness: 400 Cd/m²

Contrast ratio: 800:1

Color temperature: 6500K (adjustable)

Pixel pitch: 0.117 x 0.117 mm

Supported formats: All current HD formats

Input signals: Y,Pr,Pb

Supplied Accessories

Complete mounting kit

Short sunhood

Cabling

User's guide

* The viewfinder's LCD panel is manufactured using high-precision technology that yields a pixel response of 99.99% or higher.

EyeCatcher EC 744 Viewfinder

The OLED technology of the **EyeCatcher EC 744/15** combines the benefits of traditional black and white CRT viewfinders with the magnificent color reproduction of today, including support of the extended color gamut as defined by ITU-R BT.2020, to meet the performance needs for the most demanding of live action applications.



The EyeCatcher EC 744/15 7.4-inch HD OLED color viewfinder is the perfect match for the LDX system cameras. Its compact size and robust articulated mounting bracket make it ideal for use with a SuperXpander large lens adapter as well as in EFP configurations. The articulated mounting bracket allows the operator to move the viewfinder in many positions including straight behind the camera, which avoids blocking the view of the audience positioned behind the camera.

The EyeCatcher EC 744/15 is a compact, high-quality, 7.4-inch flat panel color viewfinder designed to work with Grass Valley LDX cameras. The stylish design allows for direct mounting to the mini wedge plate of the camera head in both EFP and SuperXpander configurations.

The OLED panel combines high brightness, high contrast ratio and high resolution with wide horizontal and vertical viewing angles, as well as an extremely fast refresh rate. This makes the EyeCatcher EC 744/15 the

perfect color viewfinder for even the most demanding applications — which include (fast moving) sports acquisition, theatrical and show productions.

The EyeCatcher has an intuitive menu structure which not only allows operators to change the viewfinder settings, but can also be used to call up the camera system menu via the viewfinder controls.

Three rotary controls — for contrast, brightness and peaking settings — are easily accessible at the front panel. In addition, three user assignable push buttons are located at the front bezel of the viewfinder. The color temperature of the display can be adjusted to match the operator's personal preference, without affecting the main video signal, allowing the operator to match the display color temperature with the color temperature of the scene.

KEY FEATURES

- 7.4-inch OLED panel
- 16:9 aspect ratio
- High brightness and extremely high contrast
- Position adjustable 1:1 pixel zoom function
- Adjustable box and markers
- Camera menu access
- Articulated mounting bracket
- Supports all current HD formats
- Supports 4K/UHD operation
- Very fast refresh rate
- SuperXpander and EFP use
- Easy accessible front controls
- Robust magnesium housing
- Supports ITU-R BT.2020 extended color gamut
- Compatible with LDX 8x Series camera heads

SPECIFICATIONS

Connectors

Camera connector: 20-pin Hirose

Controls

Menu button
3 assignable user buttons
Brightness rotary control
Contrast rotary control
Peaking rotary control

Indicators

LED indicators front:

ISO (yellow)
On-air (red)
Call (green)

LED indicators back:

2x on-air (left/right) adjustable

General

Power consumption: 12W (supplied by camera head)
Operating temperature: -20°C to +45°C (-4°F to 113°F)
Storage temperature: -25°C to +70°C (-13°F to 158°F)
Weight: 2.94 kg (6.5 lbs.)

OLED*

Diagonal size: 7.4"
Active video: 16:9 960 (H) x 540 (V) pixels (QHD)
Viewing angle: 170° horizontal, 170° vertical

Performance

Color depth: 1.07 billion colors, 10-bit color
Brightness: 350 Cd/m²
Contrast ratio: 1,000,000:1
Color temperature: 6500K (adjustable)
Pixel pitch: 0.171 x 0.171 mm
Supported formats: All current HD formats
Input signals: Y,Pr,Pb

Supplied Accessories

Extensive pan/tilt mounting bracket
Short sunhood
Cabling
User's guide

* The viewfinder's OLED panel is manufactured using high precision technology that yields a pixel response of 99.99% or higher.

LDX 82 Cameras and Accessories (LDX 82 accessories are suitable for LDX 80 cameras as well)

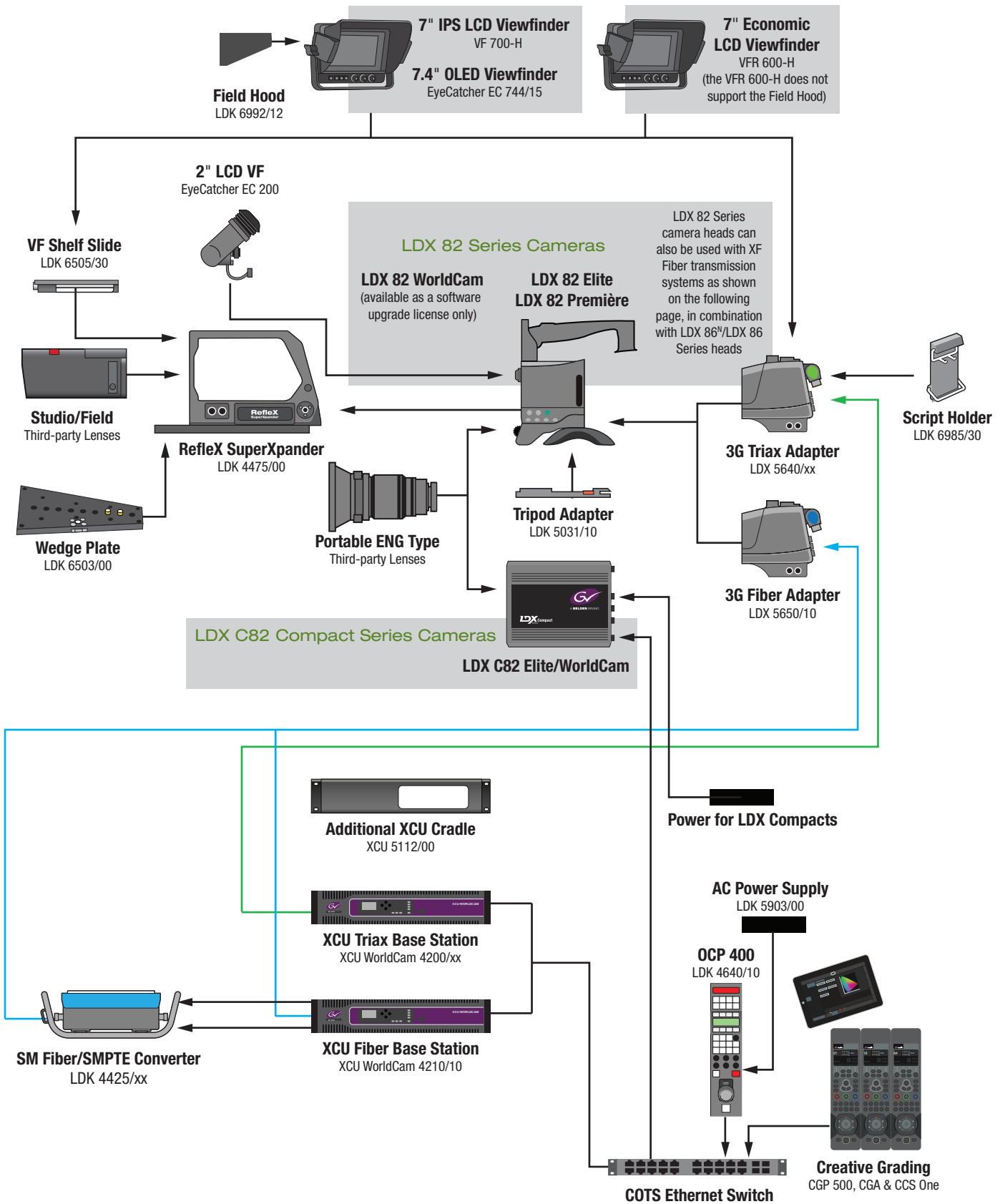

LDX 86^N/LDX 86 Cameras and Accessories

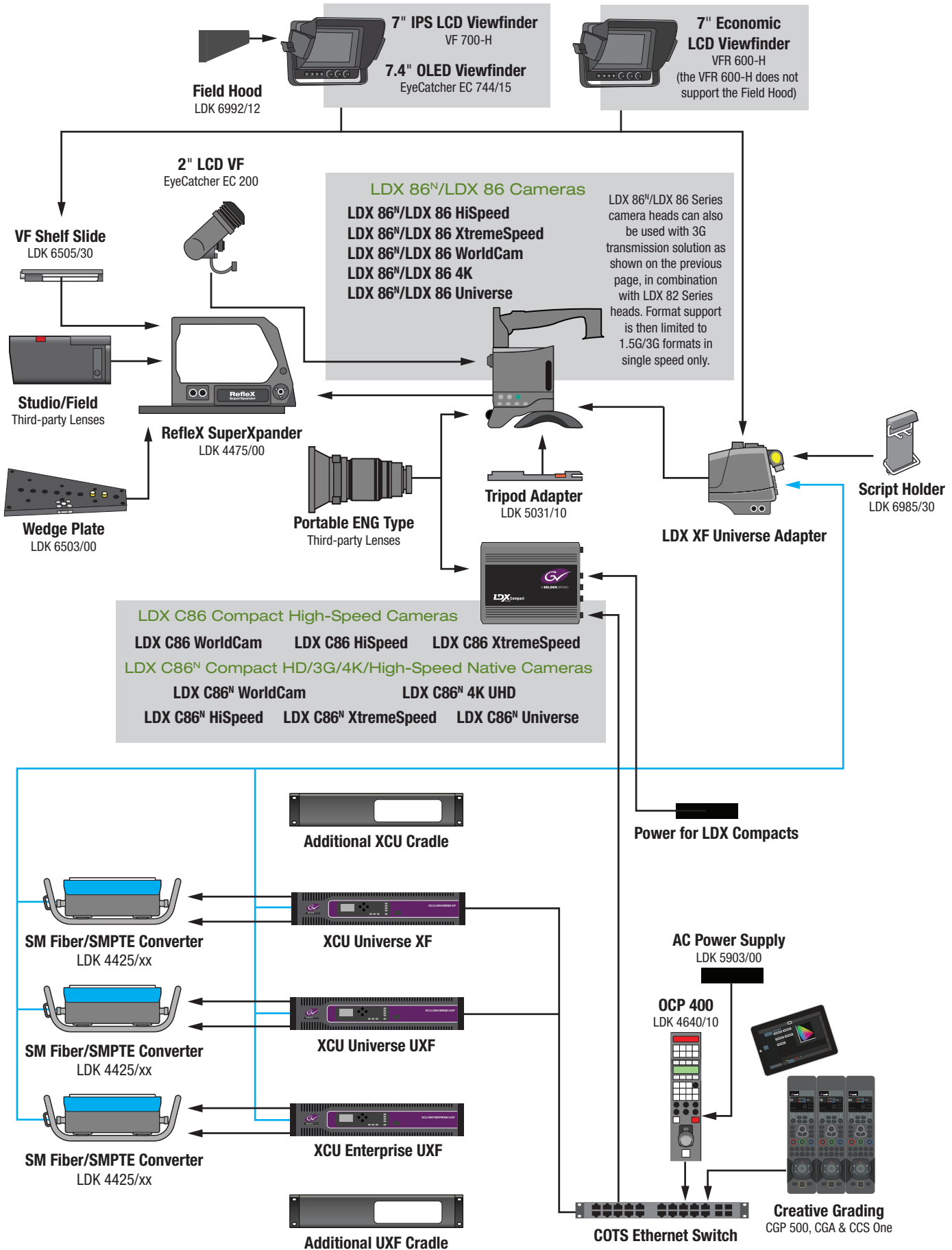

LDX SERIES CAMERAS UPGRADE PATHS

LDX 82 HD/3G

(LDX 82 WorldCam available as a software upgrade license only)

LDX 82 Première
1080i50/59.94 & 720p50/59.94

LDX 82 Elite
1080PsF23.98/24/25/29.97 & 1080i50/59.94 & 720p50/59.94

LDX 82 WorldCam
1080p50/59.94 & 1080PsF23.98/24/25/29.97 & 1080i50/59.94 & 720p50/59.94

LDX C82 HD/3G Compact (RS-LDX HD/3G)

(LDX C82 WorldCam available as a software upgrade license only)

LDX C82 Compact Elite (RS-LDX C82 Compact Elite)
1080PsF23.98/24/25/29.97 & 1080i50/59.94 & 720p50/59.94

LDX C82 Compact WorldCam (RS-LDX C82 Compact WorldCam)
1080p50/59.94 & 1080PsF23.98/24/25/29.97 & 1080i50/59.94 & 720p50/59.94

LDX C86 (Compact) High-Speed/HD/3G

LDX C86 WorldCam (HD: 1X)
1080p50/59.94, 1080PsF23.98/24/25/29.97, 1080i50/59.94 & 720p50/59.94

LDX C86 Compact HiSpeed (HD/3G: 1X, HD: 3X)
1080p50/59.94, 1080PsF23.98/24/25/29.97, 1080i50/59.94/150/179.82 & 720p50/59.94/150/179.82

LDX C86 Compact XtremeSpeed (HD: 1X/3X/6X, 3G: 1X/3X)
1080p50/59.94, 1080PsF23.98/24/25/29.97, 1080i50/59.94/150/179.82/300/359.64 & 720p50/59.94/150/179.82/300/359.64

GV-eLicense Program

Perpetual license: Perpetual upgrade to the next camera in the range
7-day term license: 7-day (weekly) term upgrade to the next camera in the range
1-day term license: 1-day (24 hours) term upgrade to the next camera in the range. They are available for the LDX 86 Series and LDX 86^N Series only in packs of 10 1-day licenses.

HDR Licenses

LDX 82 Series: 7-day or perpetual licenses for the addition of true 15 F-stop HDR operation in all single speed formats for all LDX 82 Series camera heads is available.

LDX 86 Series: 7-day or perpetual licenses for the addition of true 15 F-stop HDR operation in all single speed formats for all LDX 86 Series camera heads is available.

LDX 86^N Series: 7-day or perpetual licenses for the addition of HDR operation in all single speed formats for all LDX 86^N Series camera heads is available.

LDX C82 Compact Series: 7-day or perpetual licenses for the addition of true 15 F-stop HDR operation in all single speed formats for all LDX C82 Series camera heads is available.

LDX C86 Compact Series: 7-day or perpetual licenses for the addition of true 15 F-stop HDR operation in all single speed formats for all LDX C86 Series camera heads is available.

LDX C86^N Compact Series: 7-day or perpetual licenses for the addition of HDR operation in all HD/3G formats for both LDX C86^N Series camera heads is available.

Multiple licenses may be purchased to upgrade cameras by more than one level. Multiple 1-day and 7-day term licenses may be purchased for extended term upgrades. The B.O.W.L. licensing system provides a way to preorder any number of 1-day or 7-day licenses and activate them whenever needed without having to place individual orders. No credit is given for the purchase of 1/7-day term licenses towards the purchase of a perpetual license.

LDX 86 High-Speed/HD/3G/4K (High Sensitivity 4K)

LDX 86 HiSpeed (HD: 1X/3X) (3G: 1X)
1080p50/59.94 & 1080PsF23.98/24/25/29.97 & 1080i50/59.94/150/179.82 & 720p50/59.94/150/179.82 (HDR perpetual license available for 1X speed operation only)

LDX 86 XtremeSpeed (HD: 1X/3X/6X) (3G: 1X/3X/6X)
1080p50/59.94/150/179.82 & 1080p300/359.64 & 1080PsF23.98/24/25/29.97 & 1080i50/59.94/150/179.82/300/359.64 & 720p50/59.94/150/179.82/300/359.64 (HDR perpetual license available for 1X speed operation only)

LDX 86 WorldCam
1080p50/59.94 & 1080PsF23.98/24/25/29.97 & 1080i50/59.94 & 720p50/59.94 (HDR perpetual license available)

LDX 86 4K
3840x2160p50/59.94 & 1080p50/59.94 & 1080PsF23.98/24/25/29.97 & 1080i50/59.94 & 720p50/59.94 (HDR perpetual license available)

LDX 86 Universe (HD: 1X/3X/6X) (3G: 1X/3X/6X) (4K: 1X)
3840x2160p50/59.94 & 1080p50/59.94/150/179.82 & 1080p300/359.64 & 1080PsF23.98/24/25/29.97 & 1080i50/59.94/150/179.82/300/359.64 & 720p50/59.94/150/179.82/300/359.64 (HDR perpetual license available for 1X speed operation only)

LDX 86^N High-Speed/HD/3G/4K Native (High Resolution 4K, No Cropping/Zooming)

LDX 86^N HiSpeed (HD: 1X/3X) (3G: 1X)
1080p50/59.94 & 1080PsF23.98/24/25/29.97 & 1080i50/59.94/150/179.82 & 720p50/59.94/150/179.82

LDX 86^N XtremeSpeed (HD: 1X/3X/6X) (3G: 1X/3X/6X)
1080p50/59.94/150/179.82/300/359.64 & 1080PsF23.98/24/25/29.97 & 1080i50/59.94/150/179.82/300/359.64 & 720p50/59.94/150/179.82/300/359.64

LDX 86^N WorldCam
1080p50/59.94 & 1080PsF23.98/24/25/29.97 & 1080i50/59.94 & 720p50/59.94

LDX 86^N 4K
3840x2160p50/59.94 (native) & 1080p50/59.94 & 1080PsF23.98/24/25/29.97 & 1080i50/59.94 & 720p50/59.94

LDX 86^N Universe (HD: 1X/3X/6X) (3G: 1X/3X/6X) (4K: 1X)
3840x2160p50/59.94 (native) & 1080p50/59.94/150/179.82/300/359.64 & 1080PsF23.98/24/25/29.97 & 1080i50/59.94/150/179.82/300/359.64 & 720p50/59.94/150/179.82/300/359.64

LDX C86^N HD/3G/4K Native Compact

LDX C86^N HiSpeed (HD: 1X/3X) (3G: 1X)
1080p50/59.94 & 1080PsF23.98/24/25/29.97 & 1080i50/59.94/150/179.82 & 720p50/59.94/150/179.82

LDX C86^N XtremeSpeed (HD: 1X/3X/6X) (3G: 1X/3X)
1080p50/59.94/150/179.82 & 1080p300/359.64 & 1080PsF23.98/24/25/29.97 & 1080i50/59.94/150/179.82/300/359.64 & 720p50/59.94/150/179.82/300/359.64

LDX C86^N WorldCam
1080p50/59.94 & 1080PsF23.98/24/25/29.97 & 1080i50/59.94 & 720p50/59.94

LDX C86^N 4K
3840x2160p50/59.94 (native) & 1080p50/59.94 & 1080PsF23.98/24/25/29.97 & 1080i50/59.94 & 720p50/59.94

LDX C86^N Universe (HD: 1X/3X/6X) (3G: 1X/3X) (4K: 1X)
3840x2160p50/59.94 (native) & 1080p50/59.94/150/179.82 & 1080p300/359.64 & 1080PsF23.98/24/25/29.97 & 1080i50/59.94/150/179.82/300/359.64 & 720p50/59.94/150/179.82/300/359.64

ORDERING

Camera Heads

LDX 86^N Universe

LDX 86^N native 3840x2160/1920x1080 camera head with DPM^{Ultra}, supporting switchable 1080i, 720p, PsF, 1080p and 4K formats (1X speed), 6X speed (1080p, 1080i, 720p) and 3X speed (1080p, 1080i, 720p)

LDX 86^N 4K

LDX 86^N native 3840x2160/1920x1080 camera head with DPM^{Ultra}, supporting switchable 1080i, 720p, PsF, 1080p and 4K formats (1X speed)

LDX 86^N WorldCam

LDX 86^N native 3840x2160/1920x1080 camera head with DPM^{Ultra}, supporting switchable 1080i, 720p, PsF and 1080p formats

LDX 86^N HiSpeed

LDX 86^N native 3840x2160/1920x1080 camera head with DPM^{Ultra}, supporting switchable 3X speed (1080i, 720p) and all LDX 86^N WorldCam formats

LDX 86^N XtremeSpeed

LDX 86^N native 3840x2160/1920x1080 camera head with DPM^{Ultra}, supporting switchable 6X speed (1080p, 1080i, 720p), 3X speed (1080p, 1080i, 720p) and all the LDX 86^N WorldCam formats

LDX C86^N Universe

LDX C86^N native 3840x2160/1920x1080 camera head with DPM^{Ultra}, supporting switchable 1080i, 720p, PsF, 1080p and 4K formats (1X speed), 6X speed (1080i, 720p) and 3X speed (1080p, 1080i, 720p)

LDX C86^N 4K

LDX C86^N Compact native 3840x2160/1920x1080 camera head with DPM^{Ultra}, supporting switchable 1080i, 720p, PsF, 1080p and 4K formats (1X speed) and 1080p formats

LDX C86^N WorldCam

LDX C86^N Compact native 3840x2160/1920x1080 camera head with DPM^{Ultra}, supporting switchable 1080i, 720p, PsF and 1080p formats

LDX C86^N HiSpeed

LDX C86^N native 3840x2160/1920x1080 camera head with DPM^{Ultra}, supporting switchable 3X speed (1080i, 720p) and all LDX C86^N WorldCam formats

LDX C86^N XtremeSpeed

LDX 86^N native 3840x2160/1920x1080 camera head with DPM^{Ultra}, supporting switchable 6X speed (1080i, 720p), 3X speed (1080p, 1080i, 720p) and all the LDX C86^N WorldCam formats

LDX 86 Universe

LDX 86 camera head, supporting switchable 1080i, 720p, PsF, 1080p and 4K formats (1X speed), 6X speed (1080p, 1080i, 720p) and 3X speed (1080p, 1080i, 720p)

LDX 86 4K

LDX 86 camera head, supporting switchable 1080i, 720p, PsF, 1080p and 4K formats (1X speed)

LDX 86 WorldCam

LDX 86 camera head, supporting switchable 1080i, 720p, PsF and 1080p formats

LDX 86 HiSpeed

LDX 86 camera head, supporting switchable 3X speed (1080i, 720p) and all LDX 86 WorldCam formats

LDX 86 XtremeSpeed

LDX 86 camera head, supporting switchable 6X speed (1080p, 1080i, 720p), 3X speed (1080p, 1080i, 720p) and all the LDX 86 WorldCam formats (except PsF formats)

LDX C86 WorldCam

LDX C86 Compact camera head, supporting switchable 1080i, 720p, PsF and 1080p formats

LDX C86 HiSpeed

LDX C86 Compact camera head, supporting switchable 3X speed (1080i, 720p) and all LDX C86 WorldCam formats

LDX C86 XtremeSpeed

LDX C86 Compact camera head, supporting switchable 6X speed (1080i, 720p), 3X speed (1080p, 1080i, 720p) and all LDX C86 WorldCam formats

LDX 82 Elite

LDX 82 camera head, supporting switchable 1080i, 720p and PsF formats

LDX 82 Première

LDX 82 camera head, supporting switchable 1080i and 720p formats

LDX C82 Elite

LDX Compact camera head, supporting switchable 1080i, 720p and PsF formats

Adapters

LDX 3G Triax Adapter

LDX camera head adapter for triax transmission

LDX 3G Fiber Adapter

LDX camera head adapter for fiber transmission

LDX XF Universe Adapter

LDX camera head adapter for XF fiber transmission

Transmission Systems

XCU WorldCam Triax

XCU 3G dockable base station — triax only

XCU WorldCam Fiber

XCU 3G dockable base station — fiber only

XCU Cradle

Additional XCU cradle for all XCU base stations

XCU Universe XF

XCU with XF Fiber support for all LDX Series cameras with baseband I/Os

XCU Universe UXF XF Fiber

XCU 4K UHD/3G/HD/high-speed dockable base station with baseband and IP I/Os

XCU Enterprise UXF XF Fiber

XCU 4K UHD/3G/HD dockable base station with baseband and IP I/Os

XCU UXF Cradle

Additional XCU UXF cradle for all XCU UXF base stations

Camera Control

CGP 500

Creative Grading Control Panel

CCS One

Camera Control Server

CGA

Creative Grading App

OCP 400

C2IP camera control system control panel with joystick

Accessories

RefleX SuperXpander

Adapter for studio camera use

EyeCatcher EC 200

2-inch LCD color ocular viewfinder

VF 700-H

7-inch IPS LCD color viewfinder

VFR 600-H

7-inch economic LCD color viewfinder

EyeCatcher 744/15

7.4-inch OLED HD color viewfinder

GLOBAL SERVICES

The true benefit of a camera solution is achieved through the design and implementation based on customer requirements. The ability to tailor the solution to meet specific operational needs and configure system components accordingly sets Grass Valley camera solutions apart from its competitors. Grass Valley Global Services provides the expertise and experience to help customers define their requirements and set expectations before deploying successful implementations.

Professional Services

System functionality and performance tuning requires understanding user requirements. The ability to specify technical needs, required interfaces, bandwidth and workflow needs requires an in-depth knowledge of both the technology and the environment. Our Professional Services organization includes systems engineers with the world's highest level of this expertise. However, project success requires more than technical knowledge. To complete the picture, Grass Valley provides the project management expertise to capture specifications and to plan resources, schedule and budget. With this combination, the Grass Valley Professional Services team has the competencies and experience to insure success.

Commissioning

Grass Valley insures the success of camera solutions by personally handling the initial setup for every camera component of the system. Field engineers have the experience, knowledge and skills necessary to bring camera systems to life — both as a product set, and in the broader context of a complete solution.

Training

Grass Valley offers a range of professional training programs to help derive maximum value from Grass Valley cameras. Courses are designed for operators and maintenance engineers, with a combination of theoretical learning and hands-on exercises using Grass Valley cameras. Trainers are experienced in broadcast and in the operational and technical nuances of deploying a wide range of camera configurations.

Support Agreements

Uptime, risk and financial predictability are the hidden variables in total cost of ownership. The ability to manage these is what makes support agreements a cost-effective tool for business optimization. Grass Valley now offers an extended choice of support agreements. CamCare is a preventive maintenance service package based on periodic on-site visits at a pre-agreed schedule. CamCare aims at optimizing the health of camera inventories, minimizing the duration of service interruption and reducing repair time thanks to precise diagnostics. Elite Support Agreements provide 24x7 technical phone support, call center prioritization, service level objectives, advance parts exchange, software updates and upgrades (GV-eLicenses not included). Pick&Ship is a service included in Elite Support Agreements to simplify sending a camera in for repair for European Union customers. With Pick&Ship,

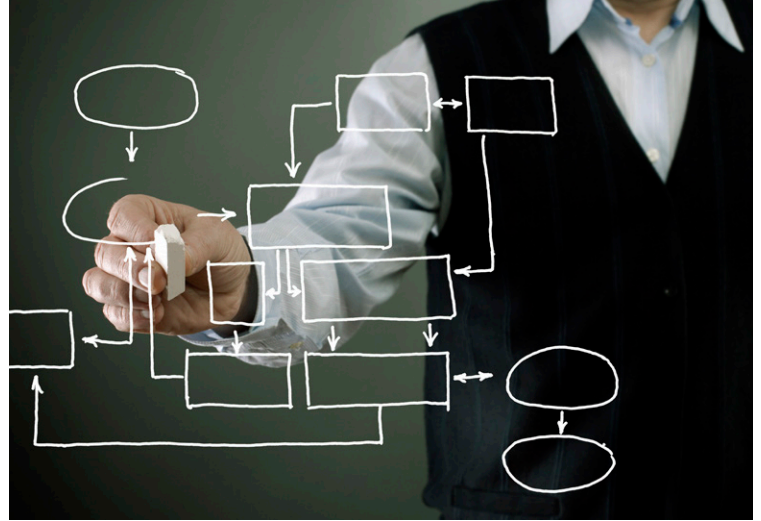

Grass Valley reduces the repair turnaround time by managing the camera shipment logistics end-to-end, from pickup to delivery and back to customer facility. Pick&Ship is currently limited to European Union countries only. Camera support agreements insure that users have both operational efficiency and financial predictability.

GLOBAL SERVICES PROVIDES:

- Unequaled depth of industry knowledge and technical expertise
- Over 50 years of worldwide experience
- Complete set of services:
 - Strategic advice
 - System architecture
 - Workflow analysis and design
 - Project management
 - Integration and implementation
 - Performance optimization
 - Technical and operational training
 - Educational services
- Address today's challenges and prepare for tomorrow's opportunities



DS-PUB-2-0161F-EN



WWW.GRASSVALLEY.COM

Join the Conversation at [GrassValleyLive](#) on Facebook, Twitter, YouTube and [Grass Valley](#) on LinkedIn.



www.grassvalley.com/blog

This product may be protected by one or more patents. For further information, please visit: www.grassvalley.com/patents.

Grass Valley®, GV® and the Grass Valley logo are trademarks or registered trademarks of Grass Valley USA, LLC, or its affiliated companies in the United States and other jurisdictions. Grass Valley products listed above are trademarks or registered trademarks of Grass Valley USA, LLC or its affiliated companies, and other parties may also have trademark rights in other terms used herein.

Copyright © 2015-2021 Grass Valley Canada. All rights reserved. Specifications subject to change without notice.