

Luna — 1RU & 2RU Router Control Panels 6028-RC & 6026-RC Series

Data Sheet

The Luna range of panels has been designed to meet the exacting requirements for hardware control panels used in simple or complex routing systems.

All panels are configured using proprietary 'RC' software launched via an applet addressed from a PC web browser.

The range consists of six 1RU panels (three LED & three LCD) and two 2RU LCD panel. All types can be configured for X-Y or BPX operational modes.

- Lightweight ergonomic design
- Fast Ethernet connection to router
- Opto-isolated GPIO ports
- Independent key allocation
- Programmable key color backlights
- Independent Source & Destination Up/Down paging Keys
- Rotary control paging on LCD types
- LCD text options
- Integral autosensing mains power supply with IEC inlet

'RC' panels are independently configured over an IP network. A configuration file can be stored and copied to other panels (of the same type) or indeed loaded to a new panel when exchanging a faulty unit.

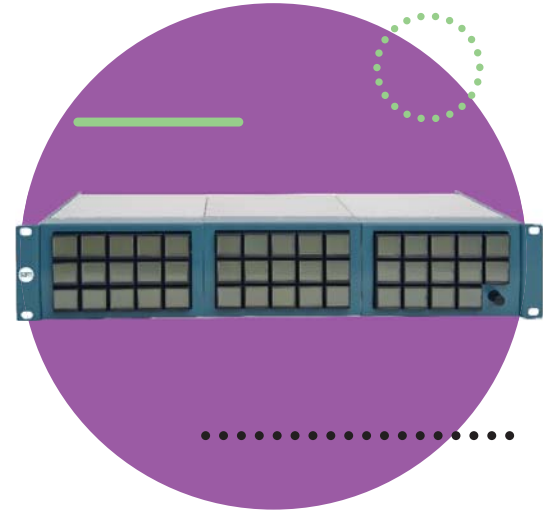

6028xxxRC - 1RU

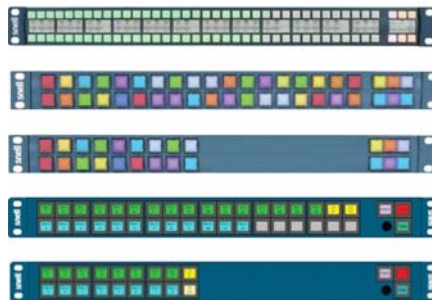

78-Key LED X-Y/BPX - 6028000RC

42-Key LED X-Y/BPX - 6028100RC

24-Key LED X-Y/BPX - 6028201RC

39-Key LCD X-Y/BPX + Rotary Control Knob - 6028251RC

21-Key LCD X-Y/BPX + Rotary Control Knob - 6028351RC



6026783RC - 2RU 71-Key LCD X-Y/BPX + Rotary Control Knob



6026481RC - 2RU 44-Key LCD X-Y/BPX + Rotary Control Knob

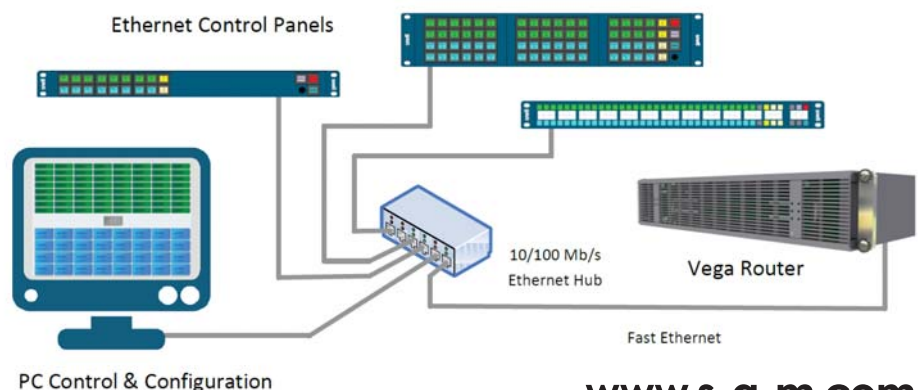

Configuration via Web Browser

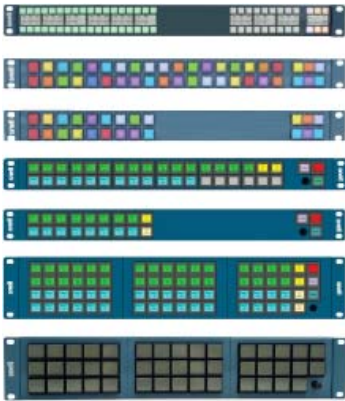

Configuration of 'RC' panels is implemented via a PC web browser. The panel applet will render on entering a default IP address. The panel address can be changed to your system requirements from the main configuration panel and the IP address of the router entered. Facility also exists to upgrade the panel configuration software over the internet should additional features be added. A set of intuitive menus allow you to custom build the panel layout to your specific needs. Once the layout has been determined, source and destination keys can be mapped to the appropriate ports on the router. For LCD panels porting of source and destination names is automatic as soon as connection is established with the router controller. Changes to the panel configuration can be made whilst a system is operational by reactivating the applet.

6028-RC and **6026-RC** control panels are compatible with Nucleus2 (246x) controllers as used in the **Sirius 800** range of routers. They are also the recommended panel types for use with the **Vega** Asymmetric router (see example system on front page). Connection to a router for all 'RC' panel types is IP Ethernet only (either directly or via a hub) over standard CAT5/6 cabling using RJ45 connectors. All the panels feature an integral auto ranging mains power supply with an IEC type inlet.

With the **6028000RC** panel printed legends are fitted between the two key rows under clear covers once the panel configuration has been defined. A legend template for this purpose is available for download from the router control panel section of our website. The **6028100RC** & **6028201RC** LED panels use individual printed legends fitted to each key cap. The LCD panels will port source and destination names once connected to the router and display them according to the text format chosen.

Panel applet in web browser

Main panel

IP address settings

Panel configuration

'Paging' settings

Button/Key configuration

Fully Flexible Source/Destination Key Positioning



'RC' panels provide 'free-form' key function and positioning with the exception of just 3 which are fixed (see next page). All of the remaining keys can be independently configured as source (SRC), destination (DST) or paging keys (optional). Panels not requiring paging can use the additional keys as SRC or DST. Shown on the right is an LCD panel in X-Y mode using a horizontal SRC/DST key layout and another with a vertical layout. In the horizontal layout, for instance, it may be that an operator would prefer the DST keys to be in the top row with the SRC keys below. This is simple to configure in the RC panel range.

Example Schemes:

1RU Horizontal SRC/DST

SRC 'Page Up' & 'Page Down'

1RU Vertical SRC/DST layout

DST 'Page Up' & 'Page Down'

2RU 'Page Up' & 'Page Down'

Source (SRC) Key

Blank Key Destination (DST) Key (No DST paging keys)

Fixed Keys & Rotary Encoder Switch (LCD only)

Positions of the 'Protect', 'Lock' and 'Take' keys (or buttons) are fixed on all panel types. If either or both the Protect and Take keys are disabled during configuration they will not display. Backlight illumination of the 'Lock/Unlocked' key can be configured as Red, Green or Amber for either status.

The LCD panel types include a Rotary Encoder Switch for 'paging' as an alternative to (or in conjunction with) the 'Page Up' and 'Page Down' keys. Pressing the rotary encoder swaps its operating mode between source and destination paging.

Optional keys that can be used with or without the 'Page Up' and 'Page Down' keys are the 'SRC Page' and 'DST Page' keys. On pressing the 'SRC Page' key, for instance, all the displayed SRC keys will change to display an array of dedicated page keys. On selecting a new page the display will revert to the new set of SRC keys associated with that page.

The number of pages (and their names) can be set during configuration. Each page can be compiled from any of the router sources and in any order. Individual sources can appear multiple times on different pages. The equivalent is true for destination pages.

All 'RC' panel types can be configured for X-Y or BPX (Button per Crosspoint) modes of operation. In BPX mode each key can be individually assigned to a destination allowing either full panel schemes or any combination and number of 'Split BPX' configurations. The example Split BPX panel shown to the left has been configured for 3 groups of BPX source keys assigned to destinations A, B and C.

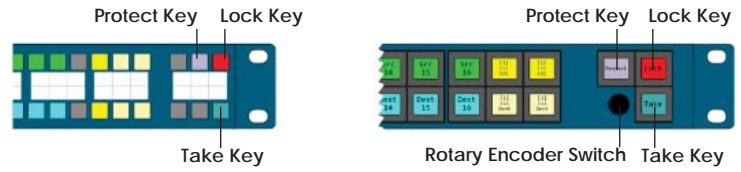

Paging - Optional 'Page Up', 'Page Down' and/or 'Page Mode' keys

Example Paging Scheme:

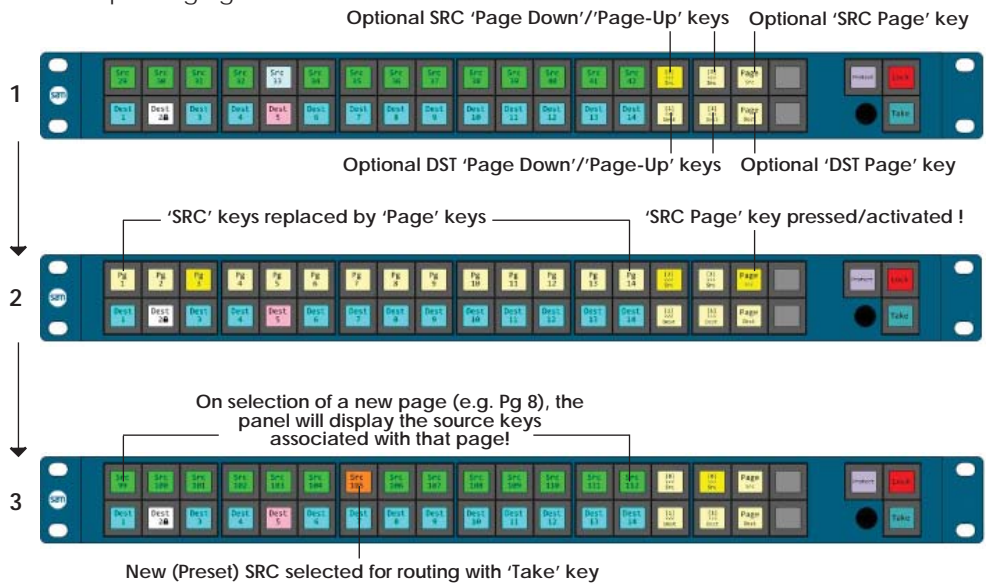

Button per Crosspoint (BPX) operation

Example BPX Schemes:

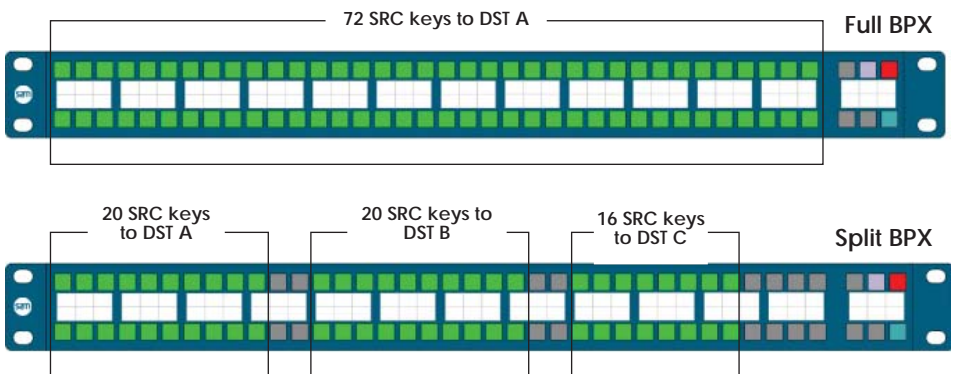

Other 'RC' Series Panel Features

Custom Key Color and Brightness

All keys/buttons are backlit with RGB LEDs (LED & LCD panels). During configuration the color and brightness for each functional key type and state can be customized depending on user preference. Alternatively factory preset value can be selected for each key type.

Illumination of 'Blank' Keys and Text insertion on LCD types

Assigned but unused keys can remain illuminated. Key color and brightness can be customized (as above) and LCD keys may include custom text.

'Joystick' Override via GPI Port

Twelve GPI 'override' inputs are available on all panel types. During panel configuration each GPI is assigned a source for routing (on GPI activation) to the currently selected destination..

Dual Mode

Some of the 1RU **6028xxxRC** panels can be configured to work in either RC (RollCall) or WB (Workbench) operational mode. The required mode can be selected very easily by the method outlined below.

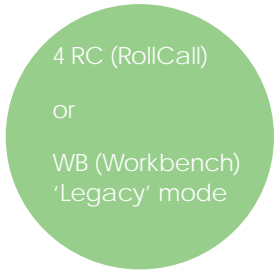

The required mode can be selected very easily by the method outlined below.

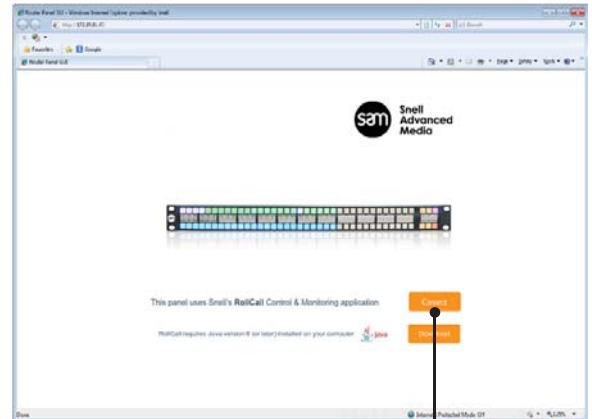

Use your PC network browser to launch panel applet and select 'Connect'!

When existing (default) mode is RC (RollCall), then configuration window below is displayed.

To enable WB (Workbench) mode select the 'Legacy Mode' radio button and select 'Restart !!'.



Access the panel again via the applet and the WB (Workbench) configuration window below will now replace the RC (RollCall) configuration window. To revert back select the 'RC Mode' radio button and then select 'Submit Mode'.

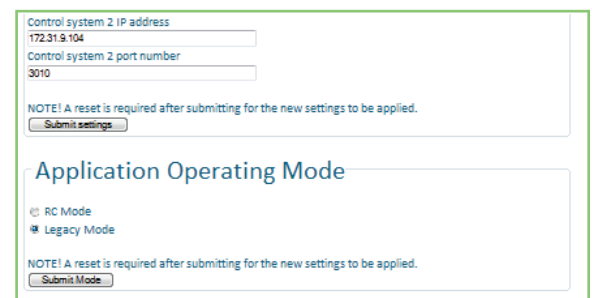

Luna — 1RU Router Control Panels in Workbench 'Legacy' Mode

Data Sheet

The three 6028xxxRC Router Control Panels described in the remainder of this document are 'Dual mode'.

They can operate in RC (Rollcall) or WB (Workbench) 'Legacy' mode.

Selecting between the desired mode is described on the opposite page.

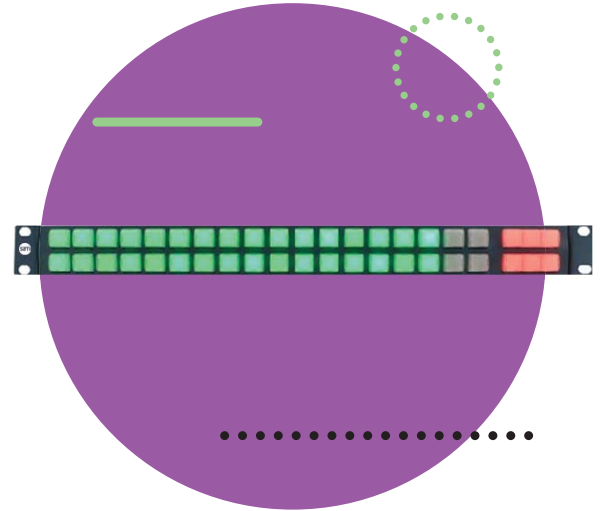

Workbench 'Legacy' Mode

- Lightweight ergonomic design
- Ethernet or multi-drop RS485 serial connection to router
- Opto-isolated GPIO ports
- Multiple configuration modess

When configured for operation in **Workbench 'Legacy'** mode the 1RU 6028xxxRC panels depicted above are compatible with the Nebula, Nucleus (2450), 2330 and Nucleus2 (246x) range of router controllers.

After the panel configuration has been defined printed legends are fitted either below or inside each key cap (dependent on panel type) for all the active keys. Legend Key templates for each panel type are available for download from the router control panel section of our website.

There are 16 alternative operational modes to choose from including X-Y and BPX panel formats. All Key LED illumination colors are as per the table below.

7028xxxRC Series for Workbench

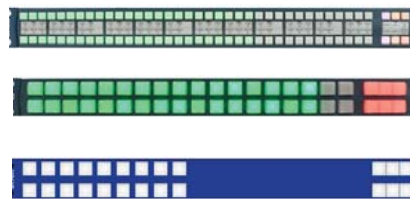

78-Key LED X-Y /BPX - 6028000RC







42-Key LED X-Y /BPX - 6028100RC

24-Key LED X-Y /BPX - 6028201RC

There are 16 alternative operational modes to choose from including X-Y and BPX panel formats.

All Key LED illumination colors are as per the table below.

Panel Key Colors (all panel types)

Key	Inactive	Selected
Source	Green 	White 
Destination	Cyan 	White 
Level	Yellow 	White 
Lock	Orange 	Red 
Protect	Orange 	Red 

Workbench 'Legacy' Mode

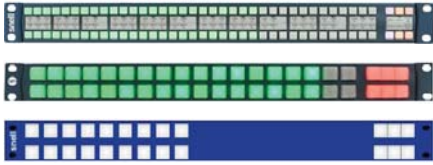

When configured for operation in Workbench 'Legacy' mode the 1RU **6028xxxRC** panels depicted above are compatible with the Nebula, Nucleus (2450), 2330 and Nucleus2 (246x) range of router controllers.

There are 16 optional panel modes available. The desired mode is selected using the configuration switches on the rear of the panel. The outline images and key descriptions for modes 1 to 8 are shown to the right. Note that not all modes are supported for all panel types.

The routers controller's database is configured using Workbench C&M software to map source and destination keys to the appropriate router input and output ports.

Mode 1

16-Way BPX

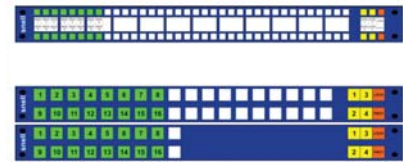
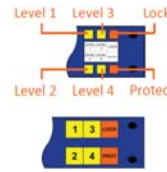

Mode 2

Dual 8 Split BPX

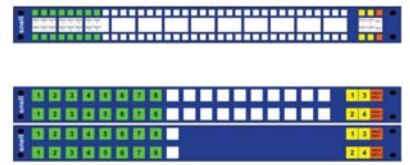
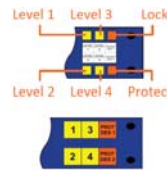

Mode 3

8 x 8 X-Y

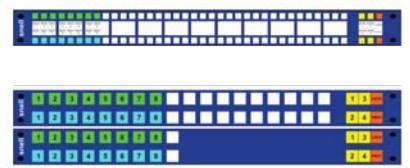
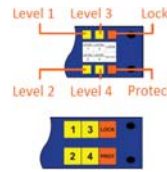

Mode 4

16 x 4 X-Y
(No Level Keys)

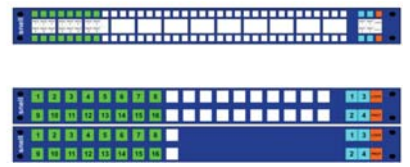
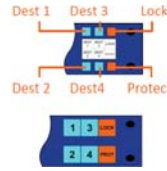

Mode 5

32-Way BPX

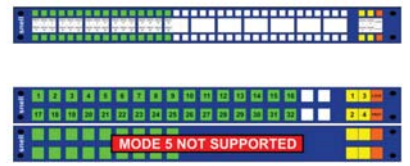
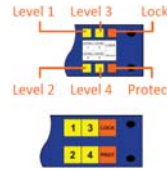

Mode 6

Dual 16 Split BPX

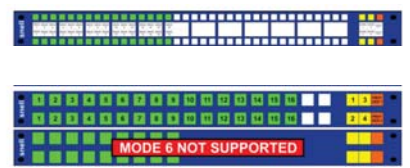
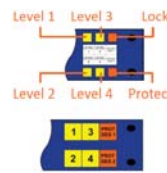

Mode 7

16 x 16 X-Y

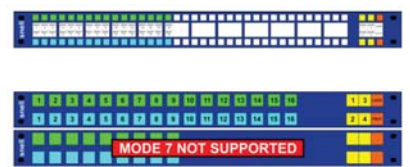
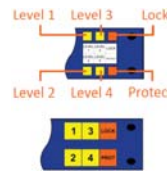

Mode 8

32 x 4 X-Y
(No Level Keys)

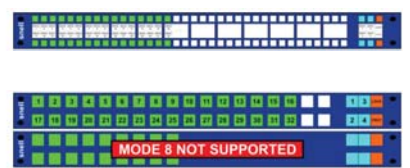
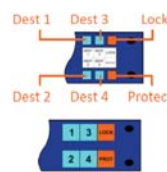

Workbench 'Legacy' Mode

Mode 9

48-Way BPX

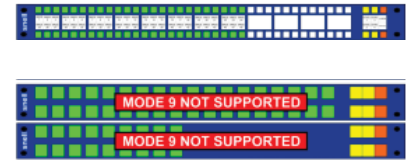
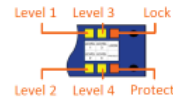

Mode 10

Dual 24
Split BPX

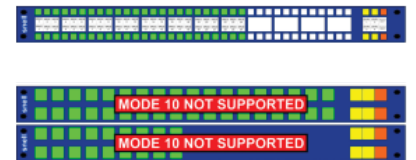
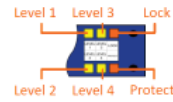

Mode 11

24 x 24 X-Y

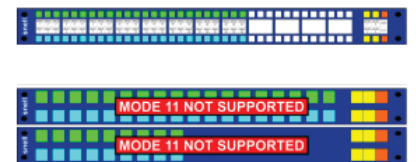
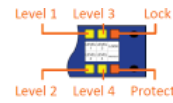

Mode 12

48 x 4 X-Y
(No Level Keys)

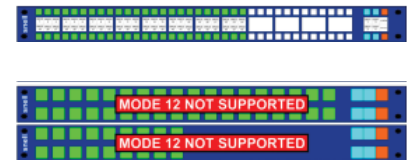
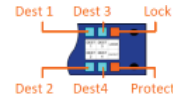

Mode 13

36 x 16 X-Y

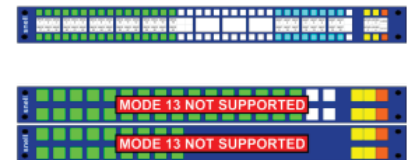
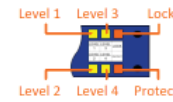

Mode 14

Dual 16 + 16 BPX

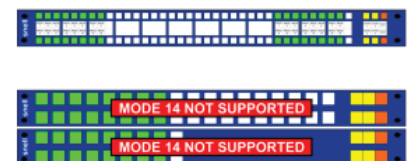

Mode 15

16 x 16 X-Y

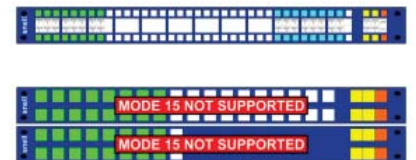
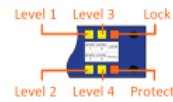

Mode 16

24 x 12 X-Y

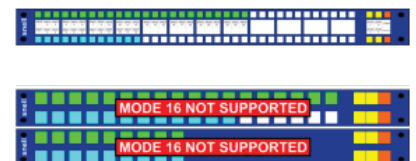

Ordering Information

6028000RCSB
1RU 78-Key LED Control Panel

6028100RCSB
1RU 42-Key LED Control Panel

6028201RCSB
1RU 24-Key LED Control Panel

6028251RCSB
1RU 39-Key LCD Control Panel with
Rotary Encoder Knob

6028351RCSB
1RU 21-Key LCD Control Panel with
Rotary Encoder Knob

6026783RCSB
2RU 71-Key LCD Control Panel with
Rotary Encoder Knob

6026481RCSB
2RU 44-Key LCD Control Panel with
Rotary Encoder Knob

IMPORTANT: The preferred panel color is SAM Blue (SB). White (WH) versions are non stocked items and available on 'Special Order' only.

Technical Specification

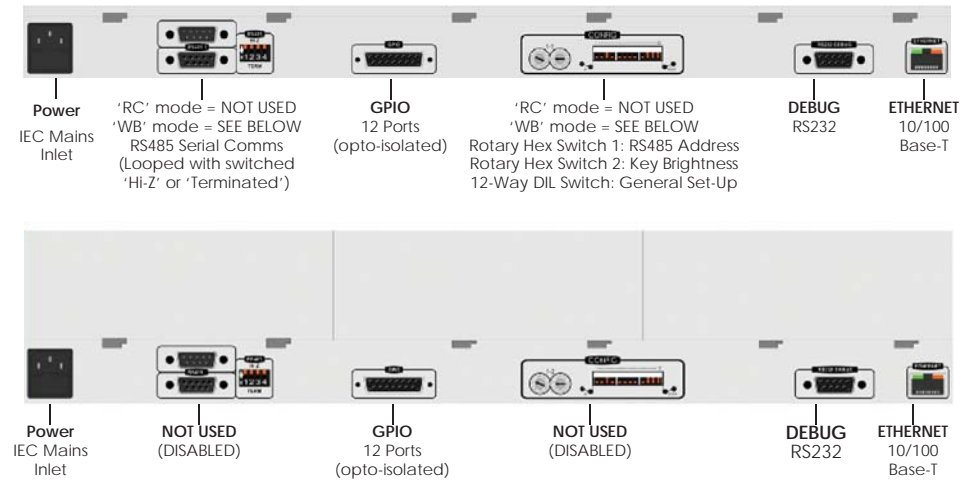

Ethernet Control		GPIO (All types)	
Physical Layer Standards	Ethernet 10/100 Base-T Mb/s	Physical Layer	Opto-coupled I/O, +5V 0.2A output
Protocol	TCP-IP	Connector	15-way D female/screw lock
Connector	RJ45 (x1)		
Serial Port Control (WB Workbench only)		Configuration (WB Workbench only)	
1RU Panel types: 6028000RC, 6028100RC & 6028201RC only			
Physical Layer Connector	RS485 9-way D female/screw lock (x2)	Rotary Hex Switch 1	RS485 Address 1 to 16 (0 - F)
4-Way DIL Switch	Select Hi-Z ('Loop-thro') or Terminate.	Rotary Hex Switch 2	Key Brightness 8 Level 0-7, 8-F unused
		12-Way DIL Switch	General 'Set-Up' & 'Mode' selections
Debug			
Physical Layer Connector	RS232 9-Way D female/screw lock	IP Switch & LED	Restore IP Address
		Reset Switch & LED	Panel Reset