



grass valley

A **BELDEN** BRAND

HCO-1822

HD/SD/ASI Change Over with Clean Switch

Guide to Installation and Operation

M955-9900-102

2017-04-18

www.grassvalley.com

Copyright and Trademark Notice

Copyright © 2011-2017, Grass Valley Canada. All rights reserved.

Belden, Belden Sending All The Right Signals, and the Belden logo are trademarks or registered trademarks of Belden Inc. or its affiliated companies in the United States and other jurisdictions. Grass Valley, Miranda, HCO-1822, iControl, and Densité are trademarks or registered trademarks of Grass Valley Canada. Belden Inc., Grass Valley USA, LLC, and other parties may also have trademark rights in other terms used herein.

Terms and Conditions

Please read the following terms and conditions carefully. By using HCO-1822 documentation, you agree to the following terms and conditions.

Grass Valley hereby grants permission and license to owners of HCO-1822 to use their product manuals for their own internal business use. Manuals for Grass Valley products may not be reproduced or transmitted in any form or by any means, electronic or mechanical, including photocopying and recording, for any purpose unless specifically authorized in writing by Grass Valley.

A Grass Valley manual may have been revised to reflect changes made to the product during its manufacturing life. Thus, different versions of a manual may exist for any given product. Care should be taken to ensure that one obtains the proper manual version for a specific product serial number.

Information in this document is subject to change without notice and does not represent a commitment on the part of Grass Valley.

Warranty information is available in the Support section of the Grass Valley Web site (www.grassvalley.com).

Electromagnetic Compatibility



This equipment has been tested for verification of compliance with FCC Part 15, Subpart B requirements for Class A digital devices.

NOTE: This equipment has been tested and found to comply with the limits for a Class A digital device, pursuant to part 15 of the FCC Rules. These limits are designed to provide reasonable protection against harmful interference when the equipment is operated in a commercial environment. This equipment generates, uses, and can radiate radio frequency energy and, if not installed and used in accordance with the instruction manual, may cause harmful interference to radio communications. Operation of this equipment in a residential area is likely to cause harmful interference in which case the user will be required to correct the interference at his own expense.



This equipment has been tested and found to comply with the requirements of the EMC directive 2004/108/CE:

- EN 55022 Class A radiated and conducted emissions
- ENV 50204 Radiated EMF Immunity – RF 900 MHz Pulsed
- EN 61000-3-2 Harmonic current emission limits
- EN 61000-3-3 Voltage fluctuations and flicker limitations
- EN 61000-4-2 Electrostatic discharge immunity
- EN 61000-4-3 Radiated electromagnetic field immunity – radio frequencies
- EN 61000-4-4 Electrical fast transient immunity
- EN 61000-4-5 Surge transient immunity
- EN 61000-4-6 Conducted disturbances immunity
- EN 61000-4-11 Voltage-dips, short-interruption and voltage variation immunity

Table of Contents

1 HCO-1822 HD/SD/ASI Change Over with Clean Switch..... 1

 1.1 Introduction 1

 1.2 Features..... 1

 1.3 Block Diagram 2

 1.4 Front Card-edge Interface 2

2 Installation..... 3

 2.1 Installation in the Densité frame 3

 2.2 Rear Panel Connector 3

3 Operation..... 5

 3.1 Control options 5

 3.2 Card-Edge Status LED 5

 3.3 Local control using the Densité frame control panel 6

 3.3.1 Overview 6

 3.3.2 Menu for local control 6

 3.4 Remote control using iControl 7

 3.4.1 The iControl graphic interface window 7

 3.4.2 The *Switch* panel 8

 3.4.3 The *Alarms* panel 11

 3.4.4 The *Timing* panel 16

 3.4.5 The *Operation Mode* panel 17

 3.4.6 The *Reference* panel 18

 3.4.7 The *Audio Embed* panel 18

 3.4.8 The *Fingerprint* panel 19

 3.4.9 The *RALM* panel 20

 3.4.10 The *Thumbnail* panel 22

 3.4.11 The *Options* panel 22

 3.4.12 The *Factory* panel 23

 3.4.13 The *Alarm Config* panel 24

 3.4.14 The *Info* panel 26

 3.4.15 User Presets 28

 3.4.16 Profiles 28

4 Specifications 31

5 Contact Us..... 32

 Grass Valley Technical Support 32

 Corporate Head Office..... 32

ANNEX – HCO-1822 User Interface 33

1 HCO-1822 HD/SD/ASI Change Over with Clean Switch

1.1 Introduction

The HCO-1822 is a 2x1 HD/SD/ASI change-over which supports 16 channels of embedded audio and Metadata. Change-overs are performed electronically by the HCO-1822's internal router. The module can perform a video and audio "Clean & Silent Switch" between sources using the CS option. In the event of a power failure, the signal is protected by relays fitted on the rear module, maintaining the integrity of the selected signal at the output. Relays are fully controllable via the GPI interface.

Input selection can be performed automatically or manually. In automatic mode, the card will perform input selection based on internal signal analysis with alarm parameters, and the status of the inputs. In manual mode, channel selection can be undertaken from the Densité Controller, the iControl software, or simply by using a GPI. A GPI can be connected to an automation system or any simple GPI control panel. The GPI outputs give status of the selected source allowing tallies to be triggered.

The preview output is user-selectable to follow the main program output or any of the video inputs.

The HCO-1822 generates audio/video fingerprints for each of the different inputs. In combination with other cards streaming fingerprints for the same signals, an optional module in iControl can measure and report lip-sync errors through the entire chain of a broadcast facility.

The module provides streaming video and audio level metering so an operator can remotely and effectively monitor the signal path using Grass Valley's iControl facility monitoring and control system.

The HCO-1822 is a 2RU card that fits a 2-slot rear module. Up to 10 modules can fit in a 2RU Densité frame.

1.2 Features

- Two source inputs and two outputs: program and preview
- Supports HD (1080i50/59.94, 720p50/59.94), SD (525,625) or ASI input
- Electronic switching with relay back up (on rear module) maintains selected input with power loss
- Automatic mode using internal signal analysis with alarm parameters
- Manual change-over by local frame controller, iControl, iControl Solo or GPI
- Alarm reporting to iControl facility monitoring and control system
- Compatible with iControl end-to-end A/V fingerprint analyzer for lip-sync error detection and measurement
- GPI in & out (IN 1, IN 2, AUTO, BYPASS)
- Optional clean switch function (video and 16 channels of audio)
- Reference input with passive loop-through
- Two line timing window with CS option
- Thumbnail and audio level meter streaming

1.3 Block Diagram

This block diagram shows the functionality of the HCO-1822.

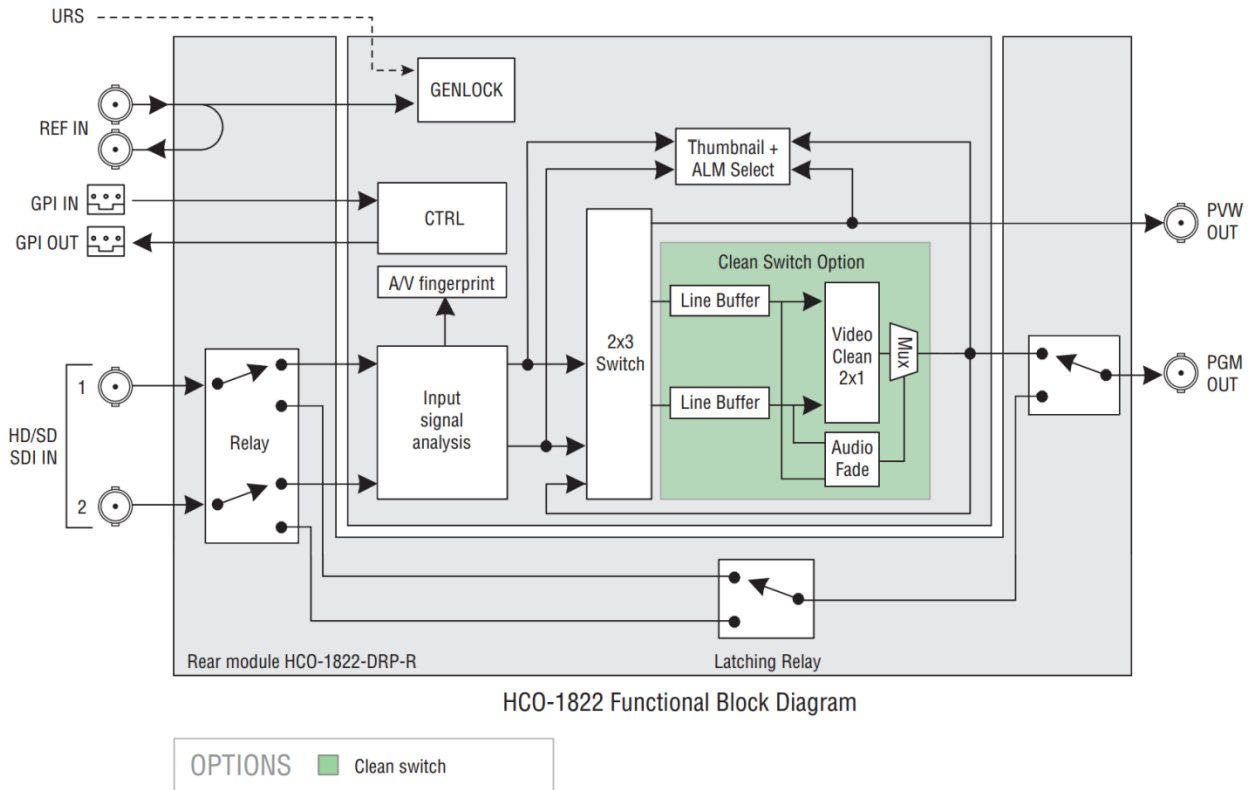

Figure 1.1 Functional block diagram HCO-1822

1.4 Front Card-edge Interface

The front card-edge of the HCO-1822 incorporates two elements:

- Status LED (see section 3.2)
- Select Button (see section 3.3)

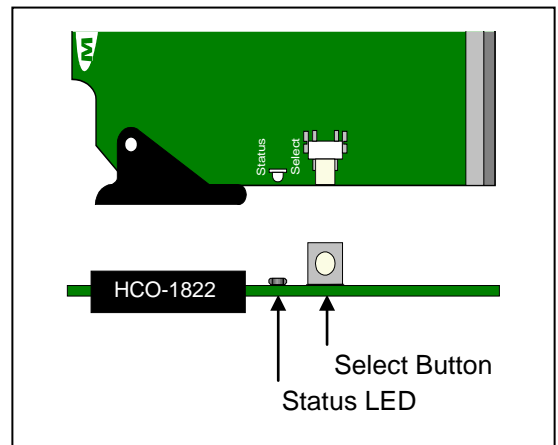

Figure 1.2 Front card-edge layout

2 Installation

2.1 Installation in the Densité frame

The HCO-1822 and its associated rear connector rear panel must be mounted in a Densité 2 frame. It is not necessary to switch off the frame's power when installing or removing the card. See the Densité 2 Frame manual for detailed instructions for installing cards and their associated rear panels.

2.2 Rear Panel Connector

The HCO-1822 has multiple inputs and outputs, and making space for all the necessary connectors at the rear of the frame requires a double-width rear panel.

With the double-width rear panel installed, the HCO-1822 must be installed in the right-most (as seen from the front of the frame) of the two slots covered by the panel in order to mate with the panel's connectors.

If it is placed in the wrong slot, the front panel LED will flash red. Move the card to other slot for correct operation. No damage will result to the card should this occur.

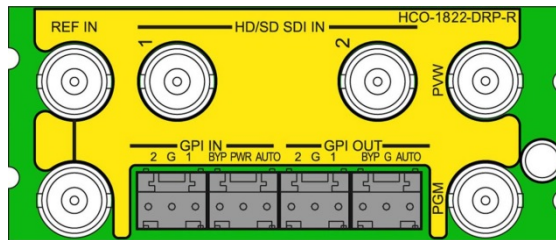

Figure 2.1 HCO-1822-DRP-R Rear Panel

The rear panel connections are as follows:

REF IN – Studio reference input

For external synchronization, connect a black studio reference signal to the BNC labeled **REF IN**. *NB: The loop must be terminated if not used.*

The reference input must conform to SMPTE 170M/SMPTE 318M/ITU 624-4/BUT 470-6 for standard definition signals and SMPTE 274M / SMPTE 296M for high definition signals and is used to phase the HD/SD SDI outputs to the studio. A reference mismatch may occur if there is a difference between the input video format's frame rate and the reference format's frame rate. When a mismatch occurs, an input error will be flagged and the card-edge Status LED will turn red to indicate the mismatch. The table shows the supported reference signals with respect to the input signals.

Supported input signals	Reference
525 (SMPTE-259M-C)	NTSC (SMPTE-170M)
625 (SMPTE-259M-C)	PAL (ITU 624-4)
1080i50 (SMPTE-274M)	1080i50, PAL
1080i59.94 (SMPTE-274M)	1080i59.94, NTSC
720p50 (SMPTE-296M)	720p50, PAL
720p59.94 (SMPTE-296M)	720p59.94, NTSC
ASI (EN50083-9)	-----

HD/SD IN – serial digital HD/SD input

Connect up to two serial digital video signal, conforming to the SMPTE 292M standard for HD input signals and SMPTE 259M standard for SD input signals, to the BNC labeled **HD/SD SDI IN**. DVB-ASI per EN 50083-9 is also supported. The HCO-1822 will automatically switch to the detected line format.

OUT – serial digital video outputs

The HCO-1822 provides two HD/SD SDI video outputs on BNC connectors, labeled **PGM** (program) and **PVW** (preview). The SDI video signals conform to the SMPTE 292M and SMPTE 259M-C standards.

GPI IN and GPI OUT connectors

The rear panel of the HCO-1822 includes a GPI interface that allows control of the switch process.

When constructing and using an external GPI box, be aware of the following:

1. The HCO-1822 card monitors the external power supply voltage on the GPI input. If the voltage is less than 4V (per relay datasheet), an alarm will be raised.
2. When a GPI INPUT is triggered while the card is operating in auto mode, the card changes to manual mode and switches to the input selected by the GPI.
3. **DO NOT TRIGGER BOTH GPI INPUTS AT THE SAME TIME OR ALLOW THE TRIGGER PULSES TO OVERLAP, AS DAMAGE TO THE RELAY MAY RESULT.**
4. A GPI trigger pulse should have a duration of at least 40 ms.

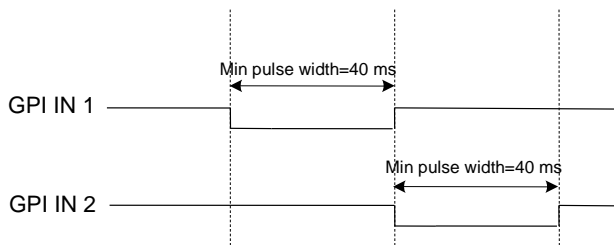

Figure 2.2 GPI trigger pulse timing

Using the GPI interface

- Trigger the GPI-IN-1 or GPI-IN-2 pin to select that input.
- Trigger the AUTO-IN or BYPASS-IN pin to select that mode
- Read the GPI-OUT-1 and GPI-OUT-2 pins to identify which output is selected
- Read the AUTO-OUT and BYPASS-OUT pins to determine whether either of these modes is in operation.

WECO connector	Pin number	GPI direction	GPI name
P1	1	IN	GPI-IN-1
	2	GND	
	3	IN	GPI-IN-2
P3	1	IN	AUTO-IN
	2	External +5V	
	3	IN	BYPASS-IN
P4	1	OUT	GPI-OUT-1
	2	GND	
	3	OUT	GPI-OUT-2
P5	1	OUT	AUTO-OUT
	2	GND	
	3	OUT	BYPASS-OUT

The four GPI connectors are laid out as shown:

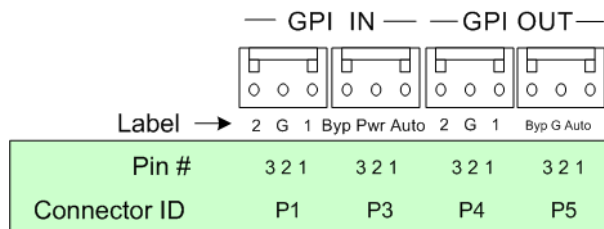

Figure 2.3 GPI Connectors

3 Operation

3.1 Control options

The HCO-1822 can be controlled in different ways:

- The local control panel and its push-buttons can be used to move through a menu of parameters and to adjust parameter values (see section 3.3).
- Grass Valley’s iControl system can be used to access the card’s operating parameters from a remote computer, using a convenient graphical user interface (GUI). (see section 3.4)

3.2 Card-Edge Status LED

The status monitor LED is located on the front card-edge of the HCO-1822, and is visible through the front access door of the DENSITÉ frame. This multi-color LED indicates the status of the HCO-1822 by color, and by flashing/steady illumination.

The chart shows how the various error conditions that can be flagged on the HCO-1822 affect the LED status.

- If a cell is gray, the error condition cannot cause the LED to assume that status
- If more than one LED status is possible for a particular error condition, the status is configurable. See Section 3.4.14 for details.
- The factory default status is shown by a ✱

The LED will always show the most severe detected error status that it is configured to display, and in the chart error severity increases from left to right, with green representing no error/disabled, and flashing red the most severe error.

Error Condition	LED Status			
	Green	Yellow	Red	Flashing Red
No errors	✱			
Backup Input			✱	
Reference Presence			✱	
Bypass Mode			✱	
Video error			✱	
Expected video format error			✱	
Input timing out of range			✱	
Reference mismatch			✱	
Black detection			✱	
Freeze detection			✱	
Audio presence group			✱	
Audio silence channel			✱	
Rear presence error				✱
Card Fan				✱

If the LED is Flashing Yellow, it means that the card is selected for local control using the Densité frame’s control panel. See Section 3.3 for details.

3.3 Local control using the Densité frame control panel

3.3.1 Overview

Push the SELECT button on the HCO-1822 card edge (see Section 1.4) to assign the local control panel to operate the HCO-1822. Use the control panel buttons to navigate through the menu, as described below.

All of the cards installed in a Densité frame are connected to the frame's controller card, which handles all interaction between the cards and the outside world. There are no operating controls located on the cards themselves. The controller supports remote operation via its Ethernet ports, and local operation using its integrated control panel.

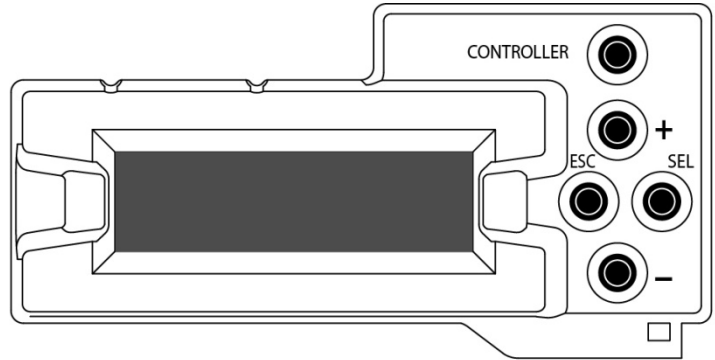

Figure 3-1 Densité Frame local control panel

The local control panel is fastened to the front of the CPU-ETH2 controller card, and when installed is located in the front center of the frame, positioned in front of the power supplies. The panel consists of a display unit capable of displaying two lines of text, each 16 characters in length, and five pushbuttons.

The panel is assigned to operate any card in the frame by pushing the SELECT button on the front edge of that card.

- Pushing the CONTROLLER button on the control panel selects the Controller card itself.
- The STATUS LED on the selected card flashes yellow.

The local control panel displays a menu that can be navigated using the four pushbuttons located beneath the display. The functionality of the pushbuttons is as follows:

[+] [-] Used for menu navigation and value modification

[SELECT] Gives access to the next menu level. When a parameter value is shown, pushing this button once enables modification of the value using the [+] and [-] buttons; a second push confirms the new value

[ESC] Cancels the effect of parameter value changes that have not been confirmed; pushing [ESC] causes the parameter to revert to its former value.

Pushing [ESC] moves the user back up to the previous menu level. At the main menu, [ESC] does *not* exit the menu system. To exit, re-push the [SELECT] button for the card being controlled.

If no controls are operated for 30 seconds, the controller reverts to its normal standby status, and the selected card's STATUS LED reverts to its normal operating mode.

3.3.2 Menu for local control

The HCO-1822 has operating parameters which may be adjusted locally at the controller card interface.

- Press the SELECT button on the HCO-1822 front card edge to assign the Densité frame's local control panel to the HCO-1822
- Use the keys on the local control panel to step through the displayed menu to configure and adjust the HCO-1822.

The complete menu structure is shown in [ANNEX – HCO-1822 User Interface](#), beginning on page 33.

3.4 Remote control using iControl

The operation of the HCO-1822 may be controlled using Grass Valley's iControl system.

- This manual describes the control panels associated with the HCO-1822 and their use.
- Please consult the iControl User's Guide for information about setting up and operating iControl.

In iControl Navigator or iControl Websites, double-click on the HCO-1822 icon to open the control panel.

3.4.1 The iControl graphic interface window

The basic window structure for the HCO-1822 is shown in figure 3.2. The window identification line gives the card type (HCO-1822) and the slot number where the card installed in its Densité frame.

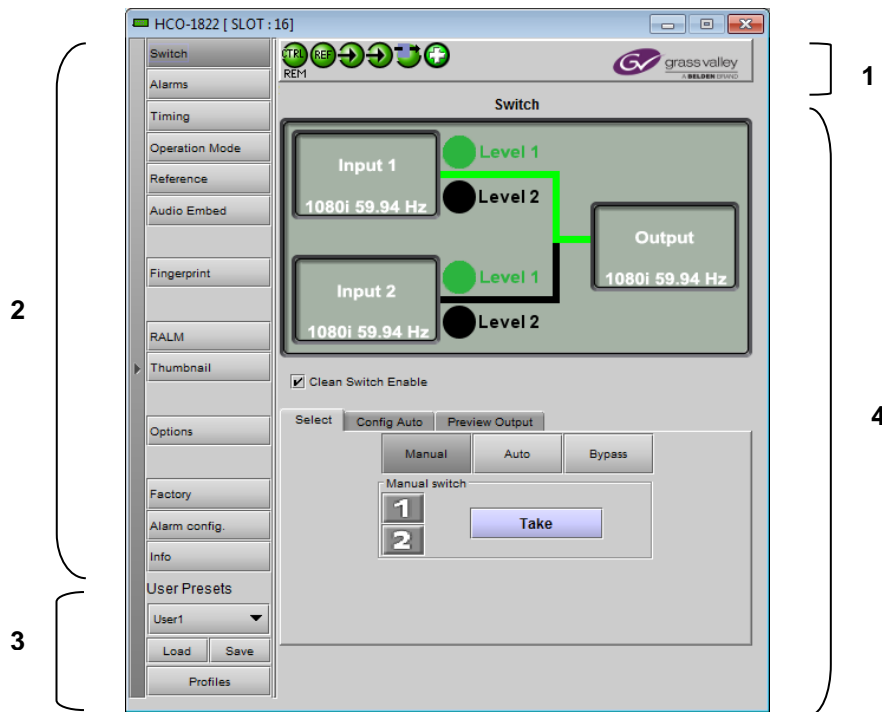

Figure 3.2 HCO-1822 iControl graphic interface window

There are four main sections in the window itself, identified in figure 3.2:

1. The Status Icon area shows a series of six icons that report the status of some card parameters. Figure 3.3 shows the various forms that may appear; their meaning is described below.

Icon 1 – Control status

- A: Green - Remote Control via iControl
- B: Yellow - Local control using the menu

Icon 2 – Reference status

- A: Green - Locked to external reference
- B: Red - Reference is missing
- C: Grey - No reference

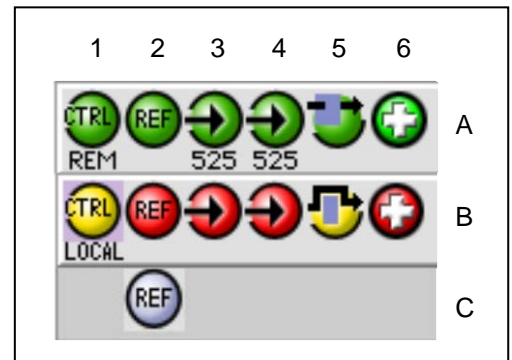

Figure 3.3 Status Icons

Icon 3 – Input 1 status

- A: Green - Status OK; format shown
- B: Red – Error

Icon 4 – Input 2 status

- A: Green - Status OK
- B: Red - Error

Icon 5 – Bypass Status

- A: Bypass not active – switch operational
- B: Bypass activated

Icon 6 – Card Heath status

- A: Green - Fan OK and GPI Power OK
- B: Red - Fan error or GPI Power Error

When an icon shows an error state, a message describing the error in more detail will appear beneath the icons. If there is more than one error, they will cycle through the display.

In all cases, mousing over an icon will cause a more detailed description of its current status to appear in the message area. Error message cycling will resume when the cursor is no longer over an icon.

Move the mouse over an icon and a status message appears below the icon providing additional information. If there is an error, the error status message appears in the message area without mouse-over.

- If there are multiple errors, the error messages cycle so all can be seen
 - The icon whose status or error message is shown is highlighted with a mauve background
2. The left-hand side of the panel contains a series of buttons that control the contents of the main window (section 4). Click on one to access the indicated controls. The selected button is highlighted (darker) and the main panel heading matched the button name.
 3. At the bottom are the controls for the User presets.
 4. This section contains the main operating controls and displays for managing the HCO-1822's feature set. The contents are selected by clicking a button on the left-hand side of the screen.

The left side of the window, containing sections 2 and 3, can be hidden or revealed by clicking the arrow icon at the center of the left side border.

Each of the panels associated with the groups accessed from the buttons in Section 2, and shown in Section 4, is described individually in the following sections.

3.4.2 The *Switch* panel

The HCO-1822 has three modes of switch operation, selected from the Select tab in the Switch control panel.

Clean switching in any of these modes is enabled by selecting the **Clean Switch Enable** checkbox.

- This activates the Timing panel, where the clean switch timing requirements can be set up. See section 3.4.4.

The graphic at the top of the panel identifies the input that is currently selected, and indicates the validity of both inputs by the color of their icons.

1. Manual switch

Manually switches the HCO-1822 output between the two possible sources: input 1 or input 2.

- Click the Manual button. The two possible sources are shown on the left. The icon representing the currently-selected input will show in green.
- Click on a different source. The selection shows blue, and the Take button is activated, appearing yellow.
- A countdown (from 10 seconds) underneath the Take button shows how long the Take button will remain active before it times out.
- Click the Take button while it is active to switch the HCO-1822 output over to the other source.

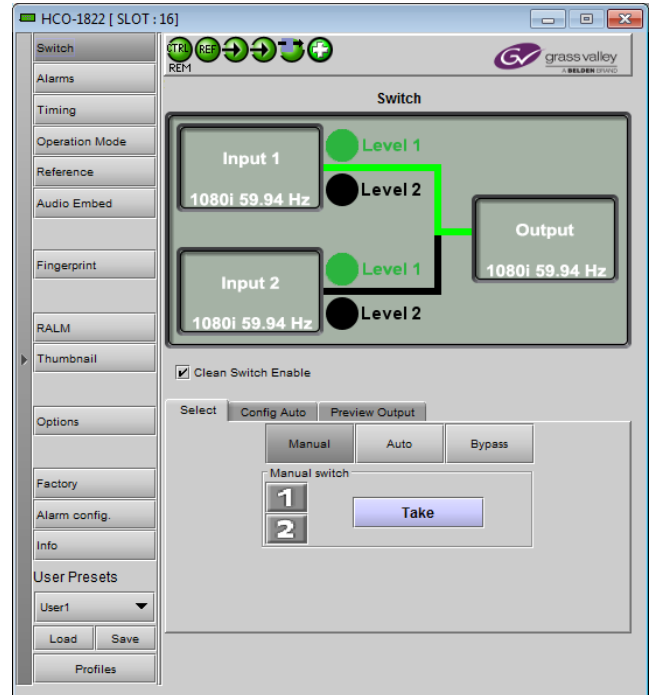

Figure 3.4 Switch panel

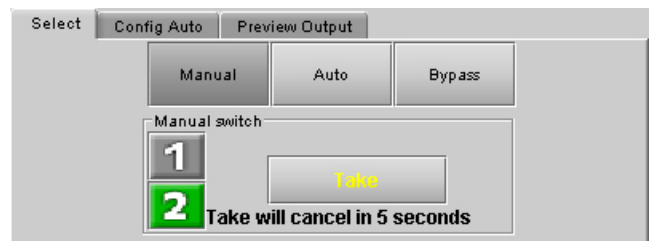

Figure 3.5 Manual Switch controls

2. Auto switch

Auto switch uses Alarms based on the status of the selected input to determine whether the other input should be selected.

- Click the Auto mode button in the *Select* tab to activate the Auto mode.

Auto mode operation:

- If Input 1 fails with an alarm level of higher priority than input 2, the HCO-1822 will automatically switch over to Input 2
- If the Switch Mode has been set to *Switch and Return* (see below), the HCO-1822 can automatically switch back to Input 1 if it has a lower alarm priority than input 2.
- If the Switch Mode has been set to *Switch To* (see below), the HCO-1822 will not switch back to Input 1 even if it has a lower alarm priority.

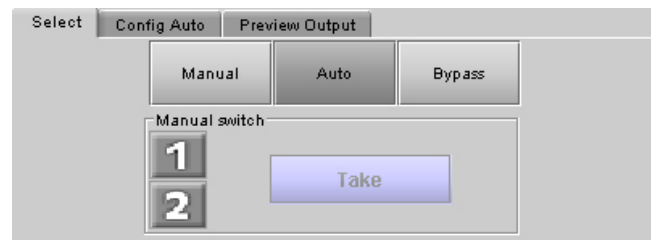

Figure 3.6 Auto Mode

- **NOTE:** for certain errors, the switch-over is delayed by 0.5 second beyond the selected duration because it often happens that the same signal is feeding both inputs, possibly offset by a frame or two. The delay ensures that the alternate feed is indeed error-free before switching to it. The errors affected are:
 - Video error (when detection duration is 1 second or more)
 - Black detect
 - Freeze detect (when detection duration is 1 second or more)
 - Audio silence detect

Select the *Config Auto* tab to select the Auto Mode functionality:

In the *Switch Mode* box, select:

- *Switch To:* switches to the input #2 (if it is valid) when the alarm conditions trigger a switch
- *Switch and Return:* switches to input #2 (if it is valid) when the alarm conditions trigger a switch, and then switches back after a predetermined interval, counted from the time the original input returns to a valid state. Use the slider at the bottom of the tab to set the interval (0 to 59 seconds, 1 to 10 minutes)
- *Toggle:* switches to the other input (if it is valid) when the alarm conditions trigger a switch. It will stay on that input until an alarm condition appears for that input in which case it will switch to the other input again (if it is valid).

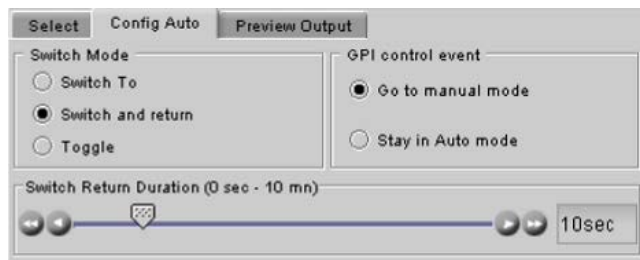

Figure 3.7 Configure the Auto Switch Mode

In the *GPI Control Event* box, select whether the HCO-1822 will change to manual mode, or remain in auto mode, when a switch is triggered from a GPI while the HCO-1822 is in auto mode.

3. Bypass

Bypass triggers relays located on the rear panel to connect the inputs directly to the outputs. The bypassed HCO-1822 card is electrically disconnected from the Densité signal system, and can be removed from the frame with no discontinuity in the signal path.

When the HCO-1822 is in Bypass:

- There is no video / audio / metadata analysis
- The PVW (preview) output is disabled
- No signal is sent to the MSB in the frame

NOTE: Grass Valley recommends that you set the HCO-1822 in BYPASS before removing it from the Densité frame to ensure no disruption in the signal when the card is removed and reinserted.

The Operating Mode can also be selected using the Menu from the local control panel (see Section 3.3), and via the GPI interface on the rear connector panel (see Section 2.2)

Preview Output tab

Use this tab to select the source for the preview output

- Auto Opposite input from that selected for the Program output
- Input 1 Input 1
- Input 2 Input 2
- Program: the same as the Program output

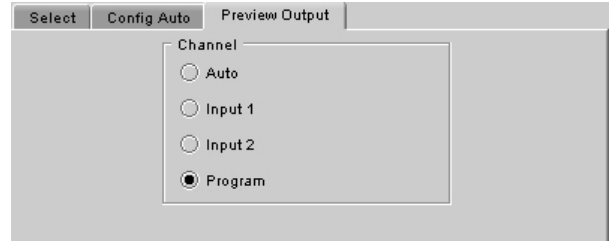

Figure 3.8 Preview output source selection

3.4.3 The Alarms panel

The HCO-1822 continuously monitors the condition and status of the input signals it is processing. The information is used to decide whether the input must be switched in Auto mode. It is also used to flag the status of the card in the iControl system.

In general:

- A number of parameter values are continuously tested against user-defined thresholds or for presence/absence.
- Each parameter test is assigned a Level, to determine the extent to which it contributes to the changeover decision.

Many alarms can be enabled or disabled using the *Enable* checkbox in their control panel (see below).

An alarm that is enabled:

- contributes to the switch decision process based on its LEVEL.
- Is reflected in the device status as reported to iControl (LEVEL has no bearing on this)

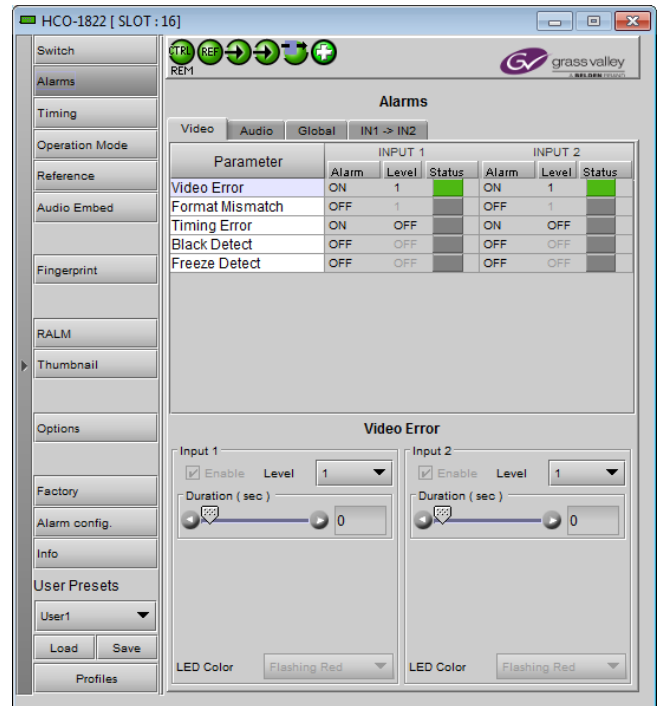

Figure 3.9 Alarms panel

Each alarm is assigned a LEVEL that determines its contribution to the switch decision process. Possible levels are:

- 1 – highest significance
- 2 – lower significance
- OFF – not used in the switch decision process

Some alarms are arbitrarily assigned as Level 1 and cannot be changed by the user (e.g. no signal present is always a Level 1 alarm). Their Enable checkbox is ticked, and greyed-out.

Other alarms have a pulldown in their control panel that allows the user to set the level.

The HCO-1822 uses the most significant alarm detected for an input as the alarm level for that input, and then uses the truth table shown here to decide whether to switch from input 1 to input 2 and back. The Alarms section of the iControl panel gives access to all alarm-

INPUT 1		INPUT 2		OUTPUT: SELECT INPUT #
Alarm level		Alarm level		
1	2	1	2	
○	○	X	X	1
○	●	○	○	2
○	●	○	●	1 or last
○	●	●	X	1
●	X	○	○	2
●	X	○	●	2
●	X	●	X	1 or last

● = Alarm at this level
 ○ = No Alarm at this level
 X = Don't care

related settings.

- The Video and Audio tabs show lists of the parameters for which alarms exist, and show the current settings for each, for both inputs.
- Click on one to select it, and the control panel for adjusting that parameter appears at the bottom of the screen.

Video – Video Error alarm

This error is always ENABLED and the level set to 1, 2 or OFF. The factory default value is level 1.

Use the slider to set the duration for which the error must continuously exist before the alarm is flagged. The nominal range of durations is 0.05 to 90 seconds. When durations ≥ 1 sec are selected, there is an additional 0.5 seconds intrinsic to the error detection algorithm that will prevent switching when there are nearly-coincident errors at the two inputs.

The LED color is not configurable.

NOTE: This is the only error that can be triggered in the ASI operating mode. All other errors will be disabled.

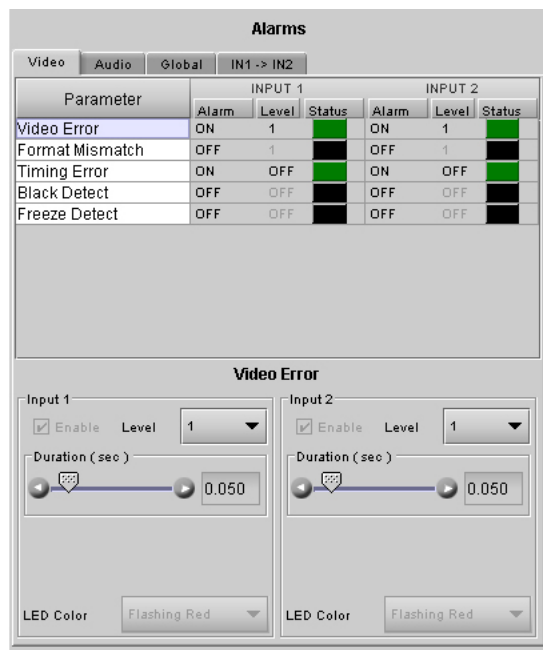

Figure 3.10 Video Error alarm configuration

Video – Format Mismatch

The user sets an expected format for each input using the pulldown in the control panel. The HCO-1822 compares this with the actual format detected at the input, and flags an error if they do not match, after a 0.5 second delay.

Formats listed in the pulldown are:

- 525
- 625
- 1080i 59.94 Hz
- 1080i 50 Hz
- 720p 59.94 Hz
- 720p 50 Hz
- SD
- HD

This error can be Enabled using the checkbox, and the level set to 1, 2 or OFF.

Use the *LED Color* pulldown to choose the color that will be displayed by the status LED on the card edge when a Format Mismatch error is detected. Choices are:

- Green, Yellow, Red, Flashing Red

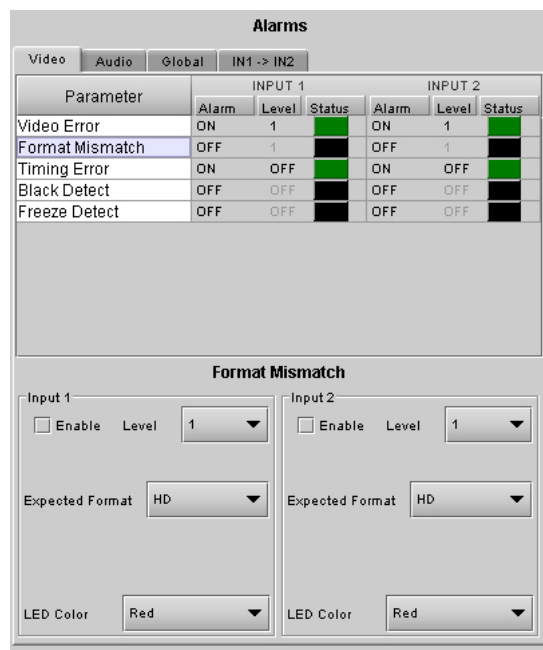

Figure 3.11 Format Mismatch alarm config

Video – Timing Error

This error is generated if the timing offset between the output signal and the video input is greater than 2 lines.

- This alarm is always enabled, but is not a switch condition for either of the inputs.

The LED color is not configurable for this alarm.

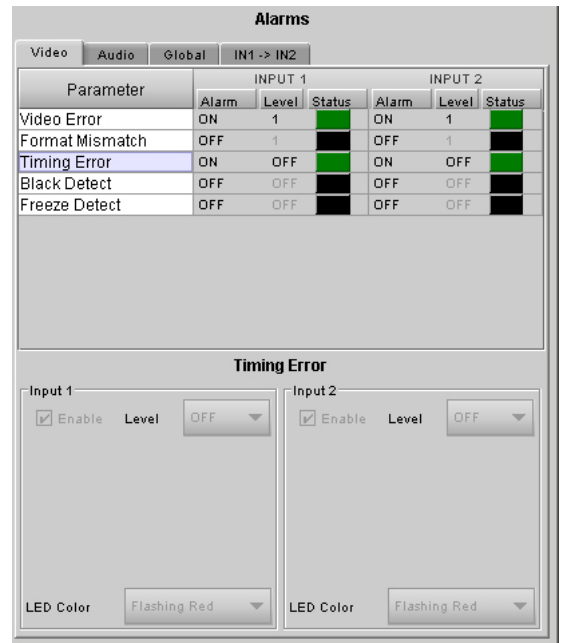

Figure 3.12 Timing Error alarm Config.

Video – Black Detect

This error detects the presence of a continuous black signal for a period of time; the error is flagged only when the time duration criterion has been satisfied.

This error can be Enabled using the checkbox, and the level set to 1, 2 or OFF.

The user sets the detection parameters for this error using two sliders:

- Threshold (mV) – sets the signal level below which Black will be considered to have been detected.
- Set Duration (sec) – sets the time interval over which Black must be continuously detected before the error is flagged. An additional delay of 0.5 sec is included to prevent switching when there are nearly-coincident errors at the two inputs.
- Clear Duration (sec) – sets the time interval during which a non-black signal must be continuously detected before a previously-flagged Black error will be cleared.

Use the LED Color pulldown to choose the color that will be displayed by the status LED on the card edge when a Black Detect error is detected. Choices are:

- Green, Yellow, Red, Flashing Red

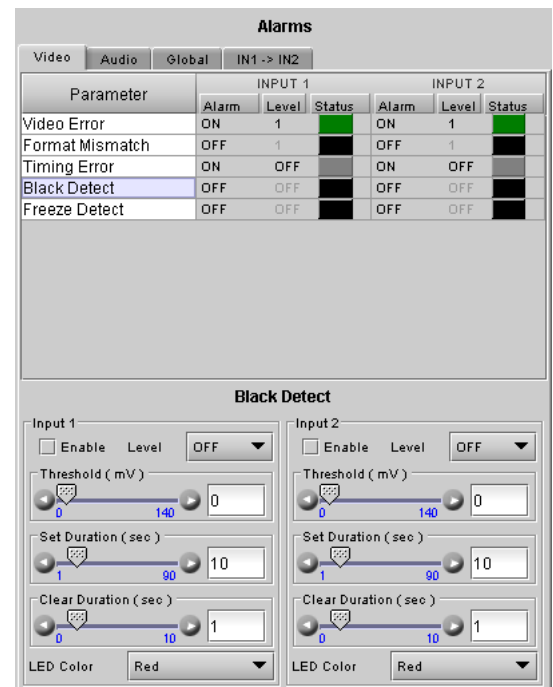

Figure 3.13 Black Detect alarm Config.

Video – Freeze Detect

This error detects the presence of a signal freeze (i.e. no change in content) for a period of time; the error is flagged only when the time duration criterion has been satisfied.

This error can be Enabled using the checkbox, and the level set to 1, 2 or OFF.

The user sets the detection parameters for this error using two sliders:

- **Threshold** – sets a sensitivity level for detection that will allow minor level changes due to noise, but will detect a lack of change in the picture content. The value (in the range 0 to 15) is arbitrary, and may need to be set by trial and error depending on the signal characteristics.

A smaller threshold value will be less tolerant to video noise than a higher value and the card may not be able to detect the freeze in presence of changing pixels. If you want to detect a pure digital video freeze, you can use the value zero. Otherwise, the threshold should be increased until a consistent freeze is detected.

- **Set Duration (sec)** – sets the time interval over which a freeze must be continuously detected before the error is flagged. The nominal range of durations is 0.5 to 90 seconds. When durations ≥ 1 sec are selected, there is an additional 0.5 seconds intrinsic to the error detection algorithm that will prevent switching when there are nearly-coincident errors at the two inputs.
- **Clear Duration (sec)** – sets the time interval during which an active signal must be continuously detected before a previously-flagged Freeze error will be cleared.

Use the *LED Color* pulldown to choose the color that will be displayed by the status LED on the card edge when a Freeze Detect error is detected. Choices are:

- Green, Yellow, Red, Flashing Red

Audio – Audio Grp 1 (same for Grp.2, 3, 4)

This error detects the absence of audio in the named group.

This error can be Enabled using the checkbox, and the level set to 1, 2 or OFF.

The user sets the detection parameter for this error using the slider:

- **Duration (sec)** – sets the time interval over which loss of audio must be continuously detected before the error is flagged

Use the *LED Color* pulldown to choose the color that will be displayed by the status LED on the card edge when an Audio Grp error is detected. Choices are:

- Green, Yellow, Red, Flashing Red

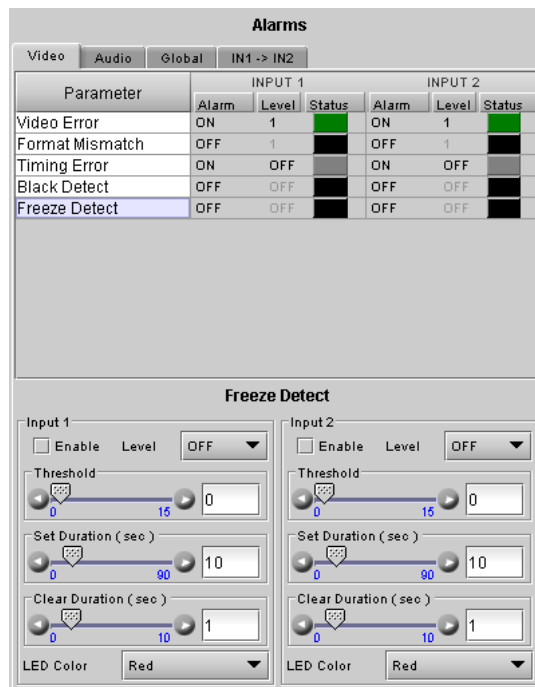

Figure 3.14 Freeze Detect alarm Config.

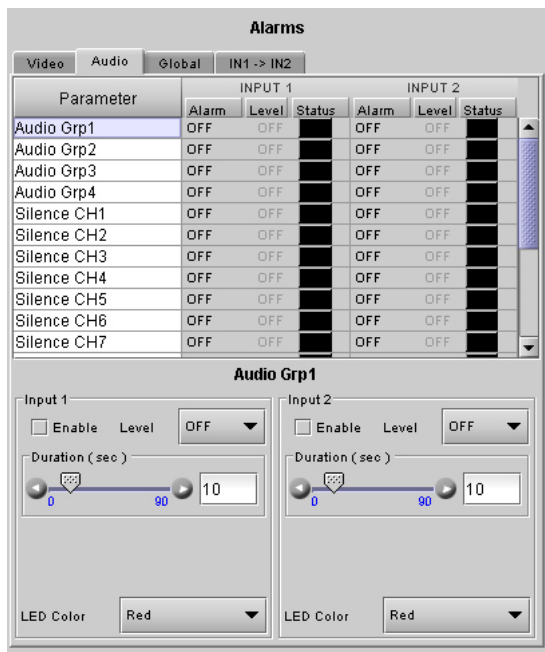

Figure 3.15 Audio Grp alarm config.

.Audio – Silence CH1 (same for CH2-16)

This error flags the continuous absence of sound level in the specified audio channel for a specified duration.

NB – this error applies only to PCM audio

This error can be Enabled using the checkbox, and the level set to 1, 2 or OFF.

The user sets the detection parameters for this error using two sliders:

- Threshold (dB) – sets the signal level below which silence will be considered to have been detected.
- Duration (sec) – sets the time interval over which silence must be continuously detected before the error is flagged. An additional delay of 0.5 sec is included to prevent switching when there are nearly-coincident errors at the two inputs.

Use the *LED Color* pulldown to choose the color that will be displayed by the status LED on the card edge when a Silence CH error is detected. Choices are:

- Green, Yellow, Red, Flashing Red

Global alarms

The parameters found under the Global tab do not have individual control panels.

These alarms DO NOT CONTRIBUTE to the switch decision process, but are included in the card status.

Four parameters are included in the Global Alarms list:

- Ref Presence – checks for the presence of a reference signal on the rear panel connector
- Backup input – LED remains Red as long as the backup input (input 2) is selected – valid in AUTO MODE only
- Bypass Mode – indicates whether the HCO-1822 is in *Bypass* mode
- GPI Power Box – detects whether a GPI box is supplying power to the GPI connector on the rear panel. Displays an error when the alarm is enabled and no power is detected.

Each parameter has two configurable features:

- *Enable* – click in the *Enable* check box to include the alarm in the card status
- *LED Color* - click on the color name in the LED Color column and a pulldown will appear offering the choice of Green, Yellow, Red or Flashing Red. The current status is shown by the colored icon in the right-hand column

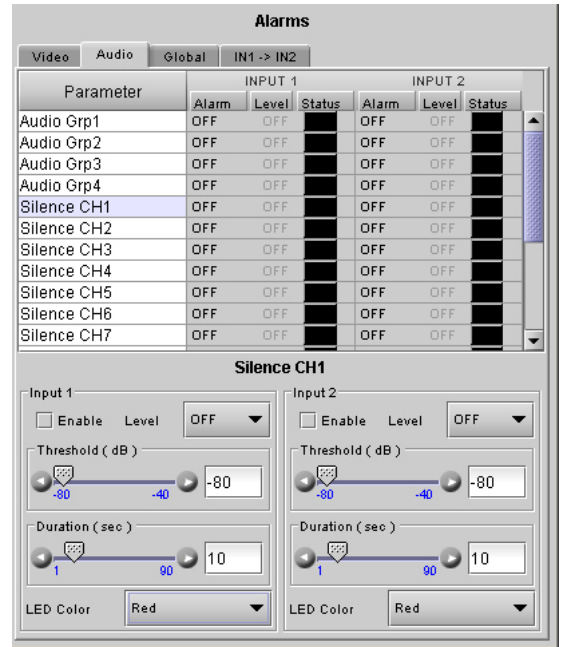

Figure 3.16 Silence CH alarm configuration

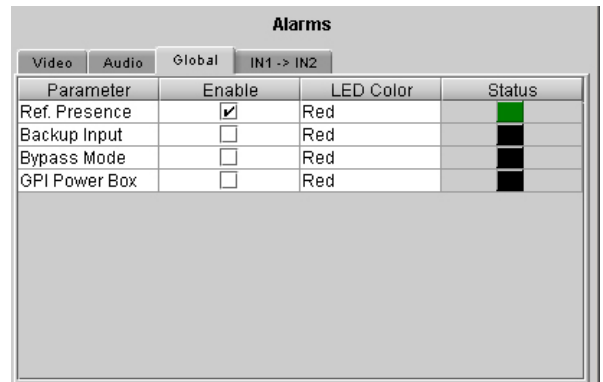

Figure 3.17 Global alarms

In1->In2

Click the checkbox to force all alarm parameters for input 2 to match those set for input 1.

- When this is selected, only one set of alarm parameters is displayed for both inputs.
- When the checkbox is deselected, the alarm parameters for input 2 revert to their previous values, i.e. as they were before the checkbox was selected.

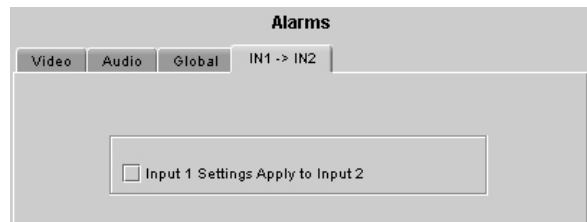

Figure 3.18 IN1 → IN2 alarm configuration

3.4.4 The Timing panel

*NOTE: this panel is only available when the **Clean Switch Enable** checkbox is selected in the Switch panel (see section 3.4.2).*

The PGM output timing, with respect to a detected reference, is programmable from -2 to +2 video lines with programmable increments at -2, -1, -1/2, 0, +1/2, +1, or +2 lines.

In order for no output timing errors to occur, the input source must be synchronized (phased) to within a pre-defined window. The size of this window will always remain the same length for a given format, but the start and end of the window is a function of the user-programmed output timing. The size of the window is [2 lines less 12.3µs] for SD sources and [2 lines less 4.5µs] for HD sources. The following examples illustrate this concept.

- Example (a) shows the supported input timing window for a user-programmed output timing of +1 line. In order for the HCO-1822 to guarantee no output timing errors, the input signal must be phased to within -1 line of the reference signal and +1 line - 12.3µs (SD) of the reference signal.
- Example (b) shows the supported input timing window for a user-programmed output timing of +1/2 line. In order for the HCO-1822 to guarantee no output timing errors, the input signal must be phased to within -1/2 line of the reference signal and +1/2 line - 12.3µs (SD) of the reference signal.

Notice for both examples, that the size of the supported input range is 2 lines - 12.3µs (SD) and 2 lines - 4.5µs (HD).

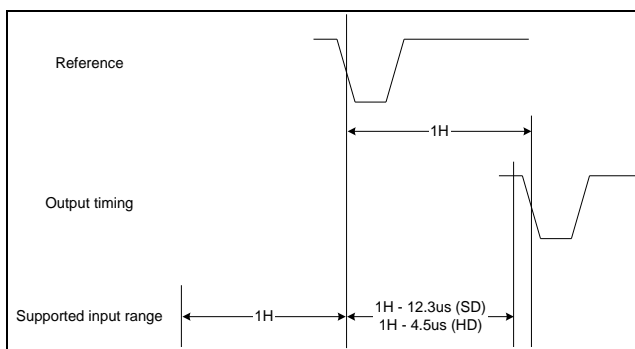

(a) Output timing = +1H

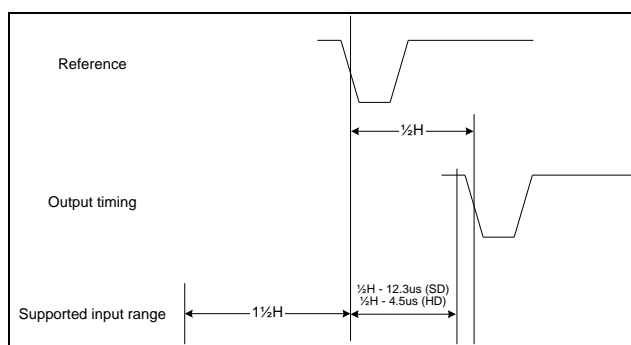

(b) Output timing = +1/2H

Figure 3.19 Output timing examples

The graphic and the text at the top of the panel show the timing of the two inputs with respect to the reference. Input timing measurements are shown above (Input 1) and below (Input 2) the user-programmed output timing (shown in blue). If the measured input timing respects the supported input window, this measurement will remain green. If not, the measurement will turn red.

Output Timing

Use the *Vertical* pulldown to offset the output from the reference by a number of video lines.

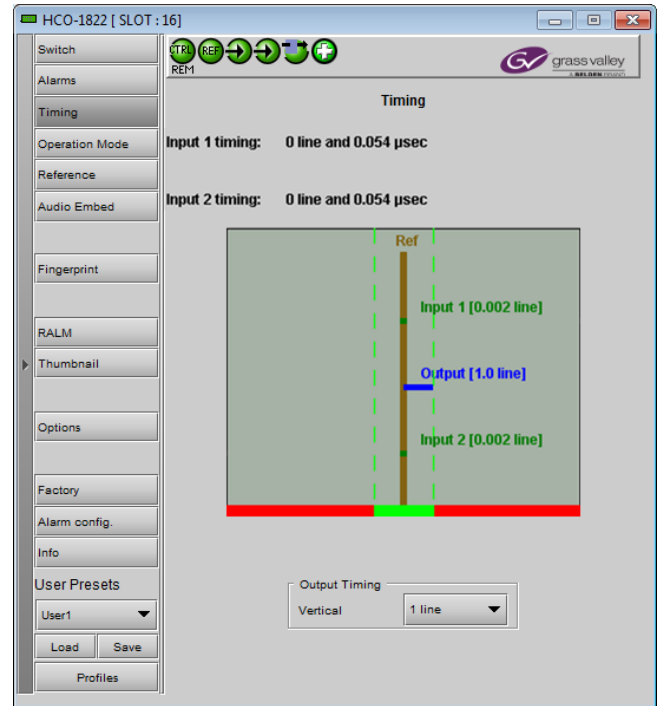

Figure 3.20 Timing panel

3.4.5 The Operation Mode panel

Use the radio buttons in the Operation Format box to choose whether this HCO-1822 will operate using HD/SD, or ASI.



Figure 3.21 Operation Mode Panel

3.4.6 The Reference panel

The HCO-1822 output signals should always be genlocked to some reference source. The genlock source is selected in the Reference control panel. Use the radio buttons in the Reference Source area to select from the following options:

- Auto – this mode selects the first source detected in this order of priority:
 - Reference input
 - URS
 - Selected Input signal
- Reference input – selects the signal connected to the rear-panel REF IN connector
- URS (Universal Reference Signal) – selects the internal reference from the backplane
- Input – uses the currently-selected input signal.

URS Format – use the radio buttons in the URS Format area to select whether the URS is OFF, 29.97 Hz or 25 Hz.

The genlock is used to assure a switch during the vertical interval of the genlock source.

See the Timing panel (section 3.4.4) for a display of the measured timing between the outputs and the reference, and to set the output timing.

3.4.7 The Audio Embed panel

SD Audio Embed Input 1 & SD Audio Embed Input 2

Use the pulldown to select the number of audio bits to be embedded at the output from these inputs.

Audio is processed in the HCO-1822 according to the following rules:

1. Supported serial formats include
 - SMPTE-299,
 - SMPTE-272M-C (Embedded audio)
2. When switching PCM audio, a fade-out / fade-in is performed on a few samples to avoid audio glitches.
3. When switching Dolby-E and AC-3 audio, no fade-out / fade-in is performed. For Dolby-E, the channel switches on the video switching line (i.e. between 2 packets).
4. Audio embedding is 20 or 24 bits (only for SD inputs).
5. 16 channels per input are supported

Note: These controls are disabled when clean switch is disabled. In this case, the HCO-1822 acts as an intelligent 2x1 router.



Figure 3.22 Reference Panel configuration

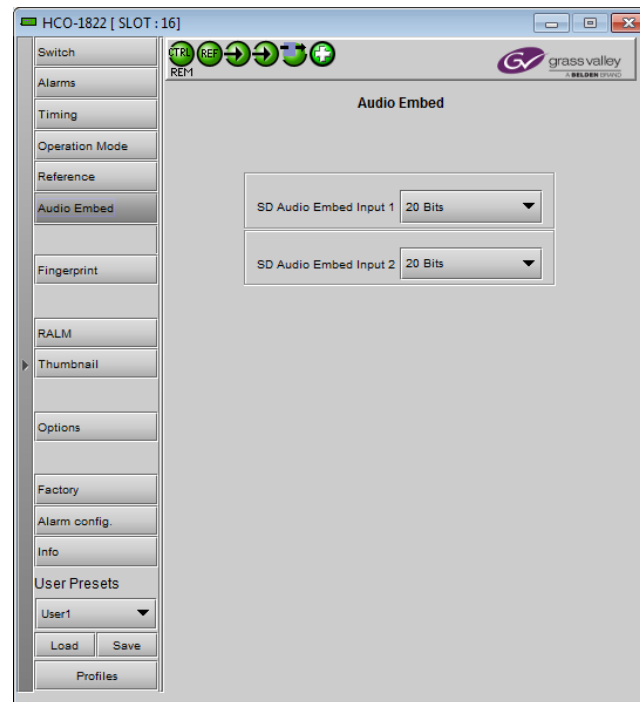

Figure 3.23 Audio Embed panel

3.4.8 The *Fingerprint* panel

Fingerprinting technology on this card functions in conjunction with iControl.

- ***iControl 4.0 and higher is required.***

HCO-1822 streaming is ON by default, but the management of the stream is handled in iControl, and there is no local control of the process at this card control panel, except to select the window, and to turn streaming OFF if there are problems with the stream or the network.

- Use the pulldown at the top of the panel to turn Fingerprint Streaming ON or OFF

See the iControl Version 4.00 User's Guide (Grass Valley document 226-99M00-271) for a description of Fingerprint management in iControl. The relevant text can be found in the section called 'Lip-Sync Detection and Monitoring' which is in the chapter titled 'Working with iControl as an Operator'

Individual fingerprints are generated for Input 1, Input 2 and PGM out. Use the tabs in the panel to select one of these.

Note: The windows for Inputs 1 and 2 can be adjusted independently. The PGM Output window settings follow those of the selected input, and are shown in the tab but cannot be adjusted there.

Zone

Select the area of the image within which fingerprint data will be calculated and streamed.

- The selected area is shown as a blue outline on the control panel window, superimposed over a thumbnail of the video.
- The thumbnail is only available when the Input Control box is selected in the Thumbnail panel.

Default Window – a factory default is specified which is applied consistently to all Grass Valley fingerprinting devices. It places the window in the central “action area” of the image, generally avoiding letterboxes and static graphics that are usually found in the periphery of the image.

Full Screen – opens the window to include the complete video image.

Start/Stop Line & Pixel – allows the user to create a custom window in response to particular or unusual image content.

- The custom window can be placed anywhere within the picture.
- Type the value into the data box and Enter, or use the scroll arrows to change the value



Figure 3.26 Fingerprint panel – Input 1 or Input 2

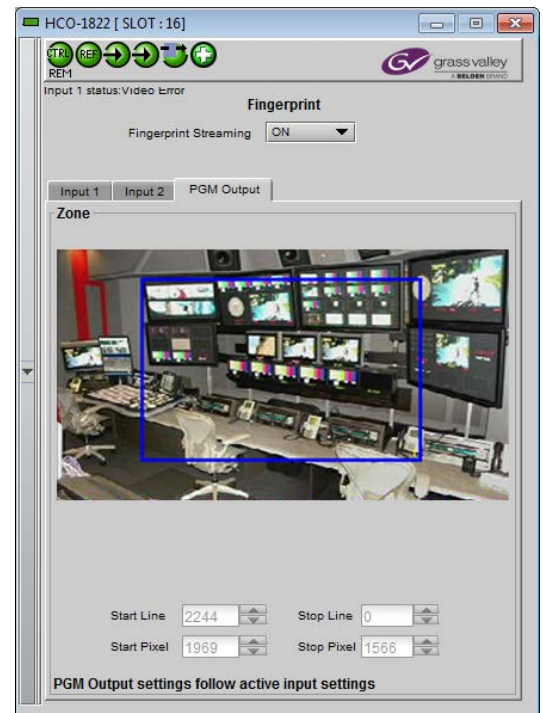
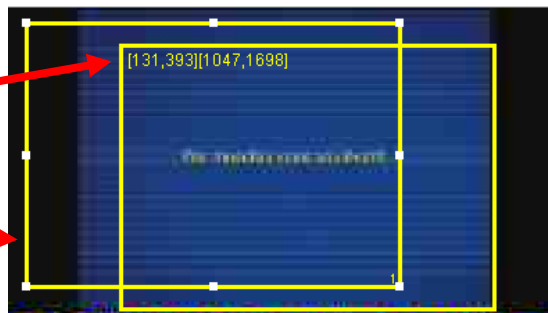

Figure 3.27 Fingerprint panel – PGM output

Use a mouse to resize – you may also use your mouse to move and resize the window. Click within the blue frame and it will turn yellow and display control handles. Mouse over a handle until the cursor switches to an arrow icon, and then drag the handle to resize the window. When you are not over a handle, the 4-arrow cursor allows you to drag the window to a new location

- While you are resizing with the mouse, the start and stop line and pixel are shown in the top left of the frame area, in this format:
[start line, start pixel][stop line, stop pixel]



- The original position of the frame remains visible, so the amount of change can easily be seen

3.4.9 The RALM panel

The Remote Audio Level Meter (RALM) panel displays audio level meters that can be assigned to audio arriving at both inputs of the HCO-1822.

Use the checkboxes in the RALM Remote Control section at the bottom of the panel to select the audio to be displayed on the meters.

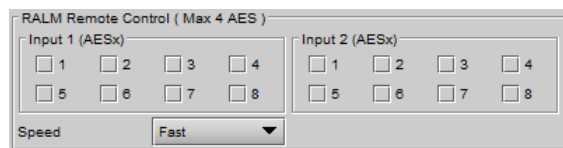

The display window is divided into two sections of two meter-pairs each.

- The left-hand section displays the audio associated with the first group selected using the checkboxes in the RALM Remote Control section of the panel (as indicated in the label above the meters)
- The right-hand section displays the audio associated with the second group selected using the checkboxes in the RALM Remote Control section of the panel (as indicated in the label above the meters)



Figure 3.28 RALM Panel

You may select any of the eight groups available in inputs 1 and 2; there is no need to select one from input 1 and one from input 2.

- A maximum of two groups can be selected at any time
- You must deselect one of the inputs before you can select another one to replace it.

Once the groups are selected, use the controls in the RALM Connections tab to turn individual meter-pairs on and off. **Speed** – select the meter response from the pull-down list, options are [fast, medium, slow]

RALM Connections tab

Use the radio buttons to turn the meter display ON (RALM) or OFF for the indicated channels. The meter appears directly above the controls.

Reset Counter: click this button to reset the overload counter on the ALM display to zero. See the next section for instructions on setting up the overload counter.



Figure 3.29 RALM Connections tab

Meter Ballistics Config tab

Type – select a type of meter from the pull-down list

The meter is divided into three zones, and the dividing points and color of each zone are individually configurable in this tab.

Upper Zone Limits – select the crossover level between the upper and middle zones of the meter (the range of values shown in the pull-down list depends on the type of meter selected)

Lower Zone Limits – select the crossover level between the middle and lower zones of the meter (the range of values shown in the pull-down list depends on the type of meter selected)

Color samples – the three samples show the current selected color for the upper, middle and lower zones of the meter.

- Click on the color sample of a zone to open a color selection panel to choose a different color for that zone

Overload Cursor – The overload cursor appears on the meter as an arrowhead in the meter scale. The two pulldown boxes set the position of the overload cursor on the left and right meters. If the audio level on that channel goes above the cursor, the Overload Counter at the top of the meter is incremented.

The *Overload Counter* shows a running count of the number of overloads detected. The Overload level is shown by a marker beside the meter, and its position can be set under the *Meter Ballistics Config* tab

The *Phasemeter* (located at the bottom of the RALM meter display) is a small meter that represents the phase correlation factor between the two channels of a pair.

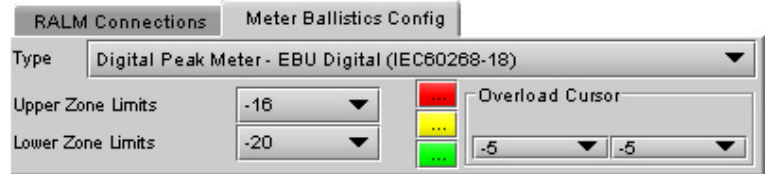

Figure 3.30 Meter Ballistics Config tab

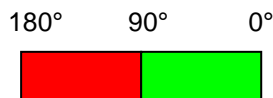
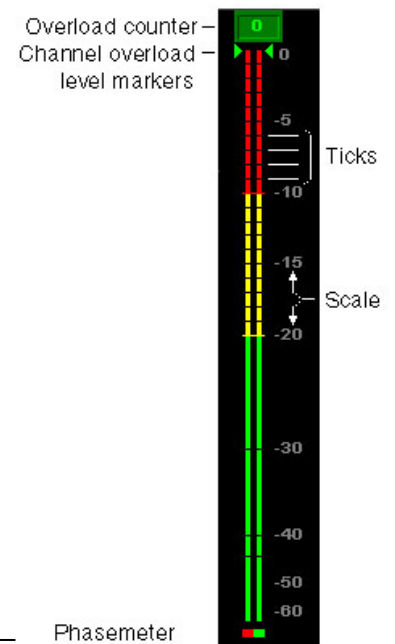

Figure 3.31 RALM meter details

3.4.10 The *Thumbnail* panel

The thumbnail area displays thumbnail images for the inputs and outputs selected in the Player area.

Player – Click the checkboxes to select which thumbnails will be displayed. Only those whose Control checkbox has been selected will be available.

- Input 1
- Input 2
- Program output
- Preview output

If only one is selected it will appear full screen, otherwise those selected will appear in a grid as shown in the figure.

Control – Click the checkboxes to apply the Mode, Format, Quality and Refresh Rate settings to these thumbnails.

Mode – select between Video mode and Test mode. Use Video mode for normal operation.

Format – choose the thumbnail size:

- small, medium, large

Quality – choose the quality of the displayed image

- Poor, Normal, HiQ

Refresh Rate – select the desired refresh rate from the pull-down box. The choices are:

[Fast, 1 sec, 2 sec, ..., 9 sec, 10 sec.]

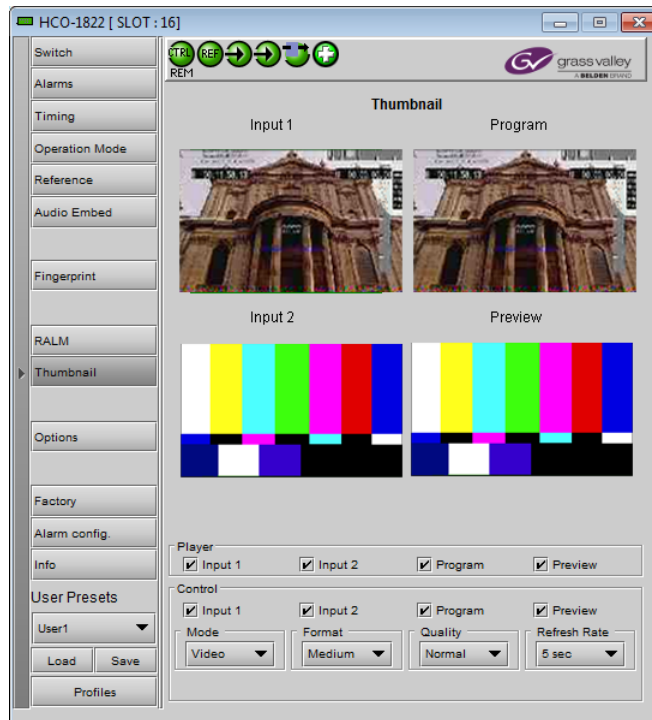

Figure 3.32 *Thumbnail Panel*

3.4.11 The *Options* panel

One option is available for the HCO-1822:

- Clean Switch Option (HCO-1822-OPT-CS)

To activate this option, you must

- Obtain a licence key from Grass Valley Technologies Inc.
- Type the licence key in the *Enter Key* box
- Click on ENABLE OPTION to enable the option's features.

Clean Switch Option – allows the HCO-1822 to make a glitch-free switch between its two inputs under certain circumstances:

1. The two inputs **MUST** have the same format.
2. An external reference or URS is recommended to run the CSO. In this mode, the reference presence is always reported, regardless of the user's setting.
3. The CSO allows us to do a clean video switch between two synchronized sources. For timing requirements between the video sources and the reference source, refer to the Genlock section. Switching is executed on

the proper vertical blanking interval video line according to the format of the reference source. (refer to SMPTE RP 168-2002: Switching point for synchronous video switching) .

4. The switch is free of any glitches, assuming the switch is not due to loss of video or CRC errors and format or reference mismatch are detected.
5. During a switch, the CSO performs a fade out/fade in audio switch on 200 samples to prevent any pops or clicks (only applicable to PCM audio)
6. The following parameters and functions are not supported without the CSO.
 - Timing measurements.
 - Output timing adjustment.
 - Glitch-free switching.
 - Reclocked outputs.
7. If there are no errors on input 1 but a reference mismatch is detected on input 2, the CSO keeps working.

The Options panel gives some information about obtaining the Clean Switch option, and provides a data entry box “Enter Key” where the activation key supplied when the option is purchased can be entered.

- Enter the Key in the data box, and click the *Enable Option* button to activate the Clean Switch feature.

3.4.12 The **Factory** panel

The HCO-1822 maintains a “Factory Default” alignment in its memory, to which it can be restored at any time.

- Click the *Load Factory* button to restore the card to its Factory default alignment.

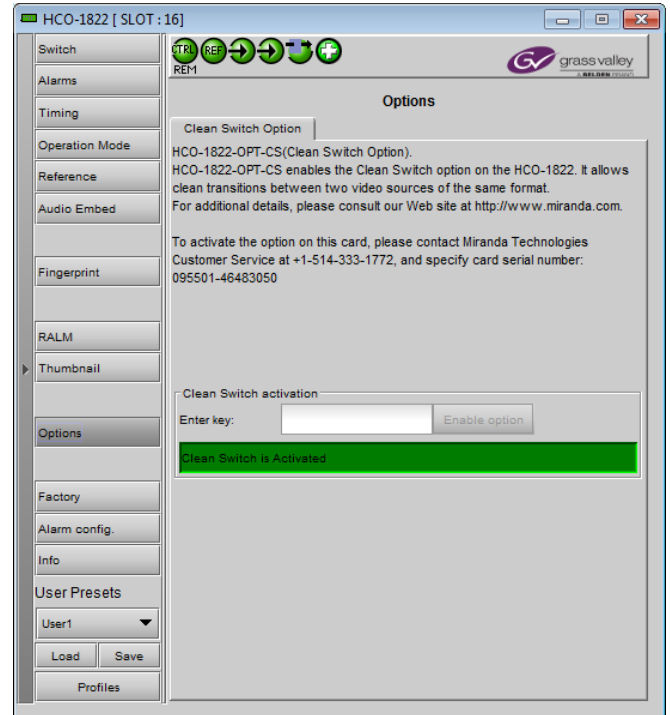

Figure 3.33 Options Panel – Clean Switch Option



Figure 3.35 Factory Panel

3.4.13 The Alarm Config panel

This panel allows the alarm reporting of the HCO-1822 to be configured. The panel opens in a new window when the button is clicked, and can be resized if needed.

The panel is organized in columns.

Status/Name

This contains an expandable tree listing all the alarms reported by this HCO-1822 card.

- Each alarm name includes an icon that shows its current status
- Some alarms may be text-only and the alarm status is shown in the name and not by a status icon, e.g.

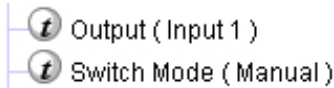

The **Overall alarm** and **GSM contribution** columns contain pulldown lists that allow the level of contribution of each individual alarm to the alarm named in the column heading to be set.

- Click on the alarm icon to see the available levels; then click on one to select it



- **Overall Alarm**

This column allows configuration of the contribution of each individual alarm to the Overall Alarm associated with this card. The Overall Alarm is shown in the upper left corner of the iControl panel, and also appears at the bottom of the Status/Name column.

- **GSM Contribution**

This column allows configuration of the contribution of each individual alarm to the GSM Alarm Status associated with this card. GSM is a dynamic register of all iControl system alarms, and is also an alarm provider for external applications. The possible values for this contribution are related to the Overall alarm contribution:

- If the Overall alarm contribution is selected as Disabled, the GSM alarm contribution can be set to any available value
- If the Overall alarm contribution is selected as any level other than disabled, the GSM contribution is forced to follow the Overall Alarm.

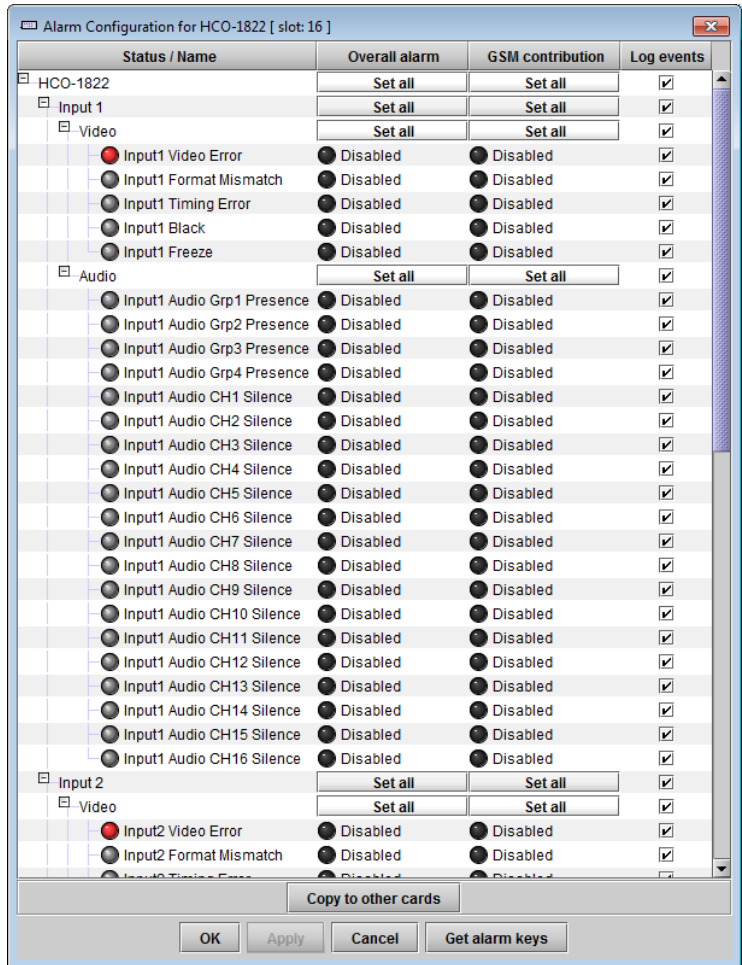







Figure 3.36 Alarm Configuration Panel

Levels associated with these alarms:

The pulldown lists may contain some or all of the following options:

-  Disabled The alarm makes no contribution (black icon)
-  Minor The alarm is of minor importance (yellow icon)
-  Major The alarm is of major importance (orange icon)
-  Critical The alarm is of critical importance (red icon)
-  Passthrough The alarm exists but has no effect (used for text and composite alarms)

Shortcut: if you click in one of the *Set All* boxes beside a section heading, you will open a pulldown that lets you assign a level to all alarms in that section of the column simultaneously.

Log Events

iControl maintains a log of alarm events associated with the card. The log is useful for troubleshooting and identifying event sequences. Click in the checkbox to enable logging of alarm events for each individual alarm.

At the bottom of the window are several other controls

Copy to other cards

Click this button to open a panel that allows the alarm configuration set for this card to be copied into another HCO-1822 card.

- Select one or more destination cards from the list in the window by clicking in the checkboxes, or all of them by clicking in the *All* checkbox
- Note that when you do a Copy Profile for this card (see Sect. 3.4.17), the alarm configuration is copied along with all the other settings.

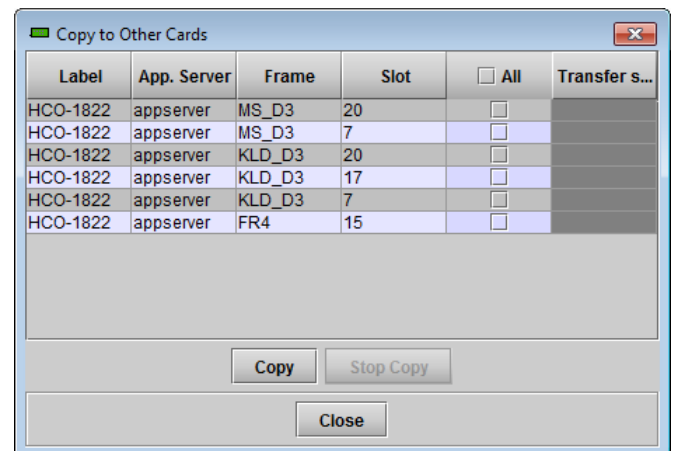

Figure 3.37 Copy to other cards

Get alarm keys

Click this button to open a save dialog where you can save a file containing a list of all alarms on this card and their current values, along with an Alarm Key for each. The alarm keys are useful for system integration and troubleshooting.

- The file is saved in .csv format

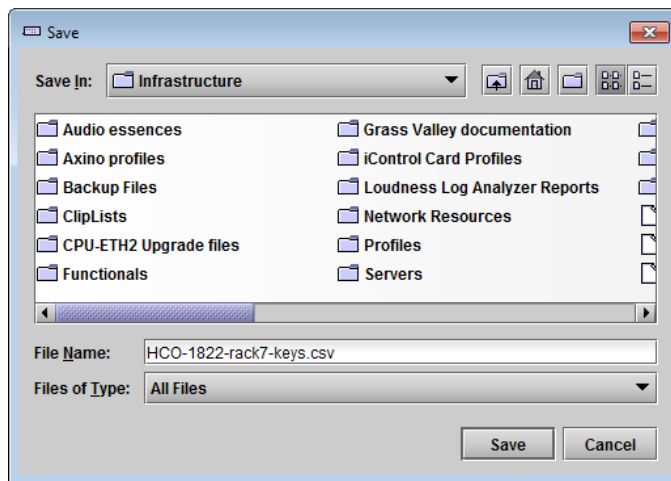

Figure 3.38 Get alarm keys save dialogue

OK, Apply, Cancel

- **OK** accepts the settings and closes the window once the card confirms that there are no errors.
- **Apply** accepts the settings, but leaves the window open
- **Cancel** closes the window without applying any changes, and leaves the previous settings intact.

3.4.14 The Info panel

When the HCO-1822 is included in an iControl environment, certain information about the card should be available to the iControl system. The user can enter labels and comments that will make this card easy to identify in a complex setup. This information is entered via the Info control panel. This panel also shows other information about the card.

Label: type the label that appear for this HCO-1822 when it appears in iControl applications

Short Label type the short-form label that iControl uses in some cases (8 characters)

Source ID type a descriptive name for this HCO-1822

Comments: type any desired text

The remaining data boxes show manufacturing information about this card.



Figure 3.39 Info Panel

- Details...: Reports the Firmware version, service version, and panel version for this card

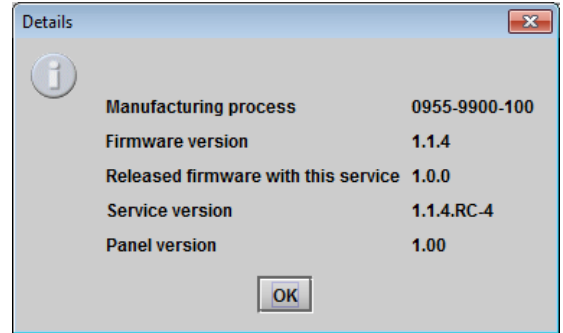

Figure 3.40 Details window

- Advanced...: Shows LongID for this card. The LongID is the address of this HCO-1822 in the iControl network.

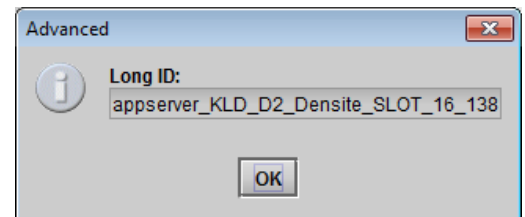

Figure 3.41 Advanced window

- Remote System Administration – opens the Joining Locators data box, which lists remote lookup services to which this HCO-1822 is registered.

Add: Force the iControl service for this HCO-1822 to register itself on a user-specified Jini lookup service, using the following syntax:

`jini://<ip_address>`

where `<ip_address>` is the ip address of the server running the lookup service

Enter the address in the Input data box. e.g.

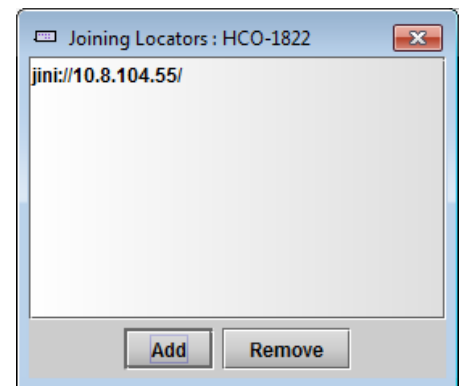
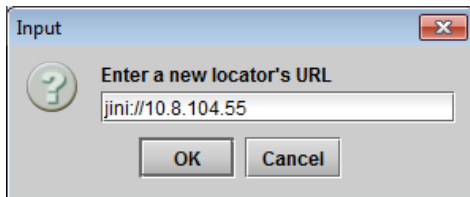
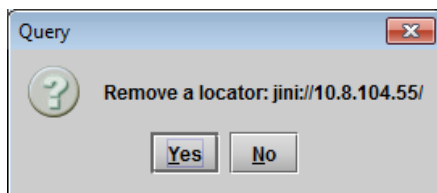

Figure 3.42 Joining Locators window



Remove: select one of the services listed in the window by clicking on it, and click *Remove* to open a query box allowing you to delete it from the window.



3.4.15 User Presets

The User Preset controls allow the user to save and recover all configuration settings on the card.

Select any one of the five presets using the pulldown list. The name of the currently-selected User Preset is shown on the on the pulldown icon (e.g. *User1*, *User2*,... *User5*)

- Click *Load* to load the contents of the selected User Preset into the HCO-1822. All parameter settings and values will be replaced by the contents of the selected User Preset.
- Click *Save* to store the current parameter settings and values from the HCO-1822 into the selected User Preset. The existing contents of the preset will be overwritten.



Figure 3.43 User Presets

3.4.16 Profiles

This section provides the option to save and recover the entire card configuration (including user presets if desired) on an external disk, or to copy it to another HCO-1822 card.

Click on the *Profiles* button at the bottom left corner of the control panel to open the Profile Copy window.

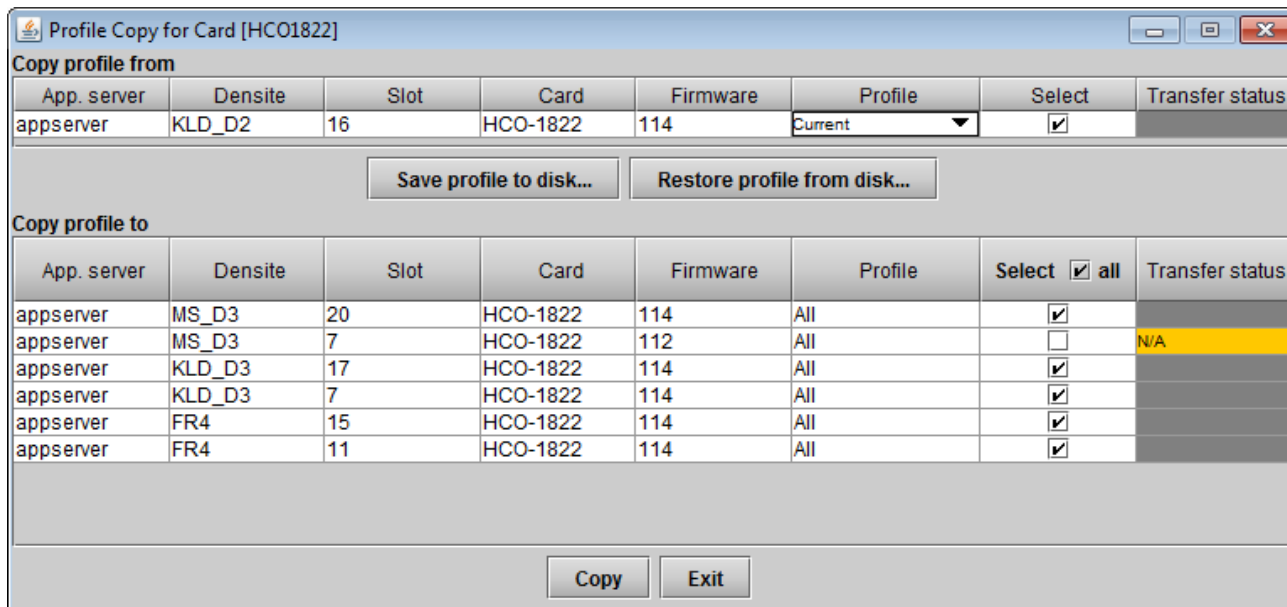

Figure 3.44 Profile copy window

Copy Profile From:

This line shows this HCO-1822 card, and identifies it by App server, Densité frame and slot number, card type and firmware version.

The *Profile* column has a pulldown that allows you to select which profiles you will work with, and gives these choices:

- Current, User1, User2, User3, User4, User5

The *Select* column includes a checkbox, preselected as checked, to confirm that you want to work with the current card.

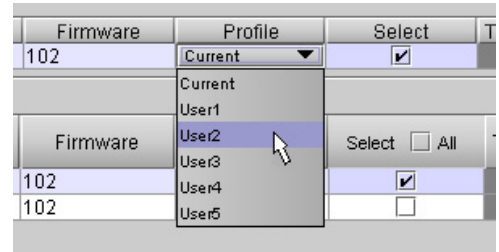

Figure 3.45 Select Profile to copy

Save Profile to Disk...

Click this button to open a Save dialog allowing you to specify a file name and location to which the selected profiles for this card will be saved.

Hint - It is a good idea to create a folder for these files, because they are not explicitly identified as HCO-1822 profiles, and will be difficult to find and identify if not clearly named and conveniently located.

- Click the save button once the name and location have been identified in the Save box
- If the file is saved correctly, the Transfer Status box on the right of the *Copy profile from* line will indicate *Succeeded* against a green background
- If the file was not saved for some reason, the Transfer Status box to the right of the *Copy profile from* line will indicate *Failed* against a red background

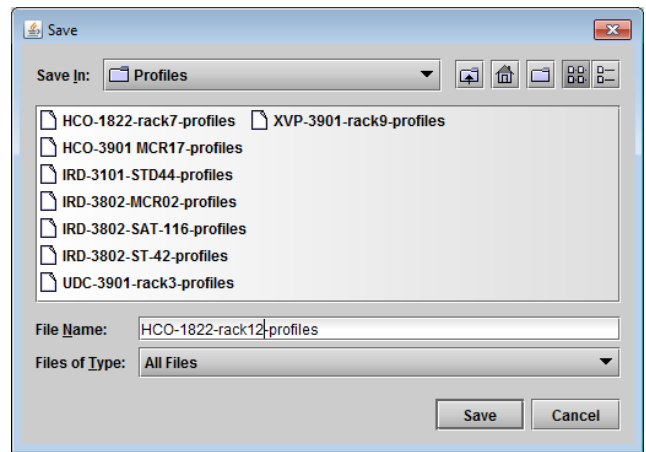

Figure 3.46 Save profile dialog

Restore profile from disk...

Click this button to open an *Open* dialog box within which you can locate and select a valid HCO-1822 profile file.

- Click Open to read the contents of the file and to reconfigure this HCO-1822's profiles according to its contents
- While the reconfiguration is in progress, the Transfer Status box on the right of the *Copy profile from* line will indicate *Working* against a yellow background
- When the reconfiguration is complete, the Transfer Status box on the right of the *Copy profile from* line will indicate *Succeeded* against a green background

Note: There is no need to select a profile using the Profile pulldown (e.g. current, User1, etc.) when restoring a profile from disk. The profile selection is stored within the file.

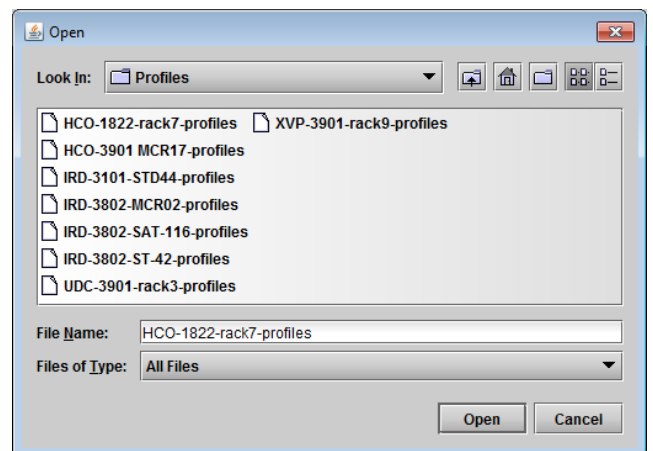

Figure 3.47 Open a profile file to restore profiles

Copy profile to section

This line shows other HCO-1822 cards that are available on the iControl network, each identified by App server, Densité frame and slot number, card type and firmware version.

The *Profile* column shows the same information as is shown for the current card in the Copy profile from line, i.e.

- Current, User1, User2, User3, User4, User5

The *Select* column includes a checkbox to identify which HCO-1822 cards you wish to copy profiles into from the current card.

- For convenience, a *Select all* checkbox is provided in the column header

Click *Copy* to copy the selected profiles from this card into the selected other HCO-1822 cards

- While the profile copy operation is in progress, the Transfer Status box on the right of the *Copy profile to* line will indicate *Working* against a yellow background
- When the profile copy operation is complete, the Transfer Status box on the right of the *Copy profile to* line will indicate *Succeeded* against a green background

4 Specifications

Video inputs (2)

SIGNAL	SD: SMPTE-259M-C (270Mbps), HD: SMPTE-292M (1.485, 1.485/1.001 Gbps), DVB-ASI : EN 50083-9
SUPPORTED FORMATS	SD: SMPTE-125M: 480i59.94 SD: EBU: 576i50 HD: SMPTE-274M: 1080i59.94, 1080i50 HD: SMPTE-296M: 720p59.94, 720p50
CABLE LENGTH	200 m (700') Belden 8281 at 270 Mbps 90 m (300') Belden 1694A at 1.485 Gbps
RETURN LOSS	>15 dB up to 1.5 GHz

Video outputs (PGM and PVW)

SD mode

SIGNAL (2)	SMPTE-259-C (270 Mbps)
SUPPORTED FORMATS	SD: 480i59.94, 576i50
RETURN LOSS	>15 dB up to 270 MHz

HD mode

SIGNAL (2)	SMPTE 292M (1.485, 1.485/1.001 Gbps)
SUPPORTED FORMATS	HD: SMPTE 274M: 1080i59.94, 1080i50 HD: SMPTE 296M: 720p59.94, 720p50
RETURN LOSS	>15 dB up to 1.5 GHz (PGM out) >15 dB up to 1.0 GHz >12 dB up to 1.5 GHz (PVW out)
JITTER	<0.2UI as per SMPTE-292M

Reference input

SIGNAL (1)	SMPTE 170M/SMPTE 318M/ITU 624-4/BUT 470-6 or composite sync SMPTE 274M / SMPTE 296M Tri-level sync
RETURN LOSS	>35 dB up to 5.75 MHz

GPI (8)

Connector:	Weco, opto isolated
GPI IN (4)	Used to select input and card's mode of operation
GPI OUT (4)	Used for tallies to gives status of selected input and card's mode of operation

Video Processing Performance

SIGNAL PATH:	10 bits
LATENCY	0.4 ns without CS option Maximum of 2 lines with CS option

Audio Processing Performance

QUANTIZATION:	20-24 bits
SAMPLING:	48 KHz, synchronous
NUMBER OF CHANNELS:	16, 4 Groups
AUDIO LATENCY	0.4 ns without CS option <ul style="list-style-type: none"> ▪ Add 1 ms if CS option is enabled.

POWER	8 W
--------------	-----

5 Contact Us

Grass Valley Technical Support

For technical assistance, contact our international support center, at 1-800-547-8949 (US and Canada) or +1 530 478 4148.

To obtain a local phone number for the support center nearest you, please consult the *Contact Us* section of Grass Valley's website (www.grassvalley.com).

An online form for e-mail contact is also available from the website.

Corporate Head Office

Grass Valley
3499 Douglas-B.-Floreani
St-Laurent, Quebec H4S 2C6
Canada

Telephone: +1 514 333 1772

Fax: +1 514 333 9828

www.grassvalley.com

ANNEX – HCO-1822 User Interface

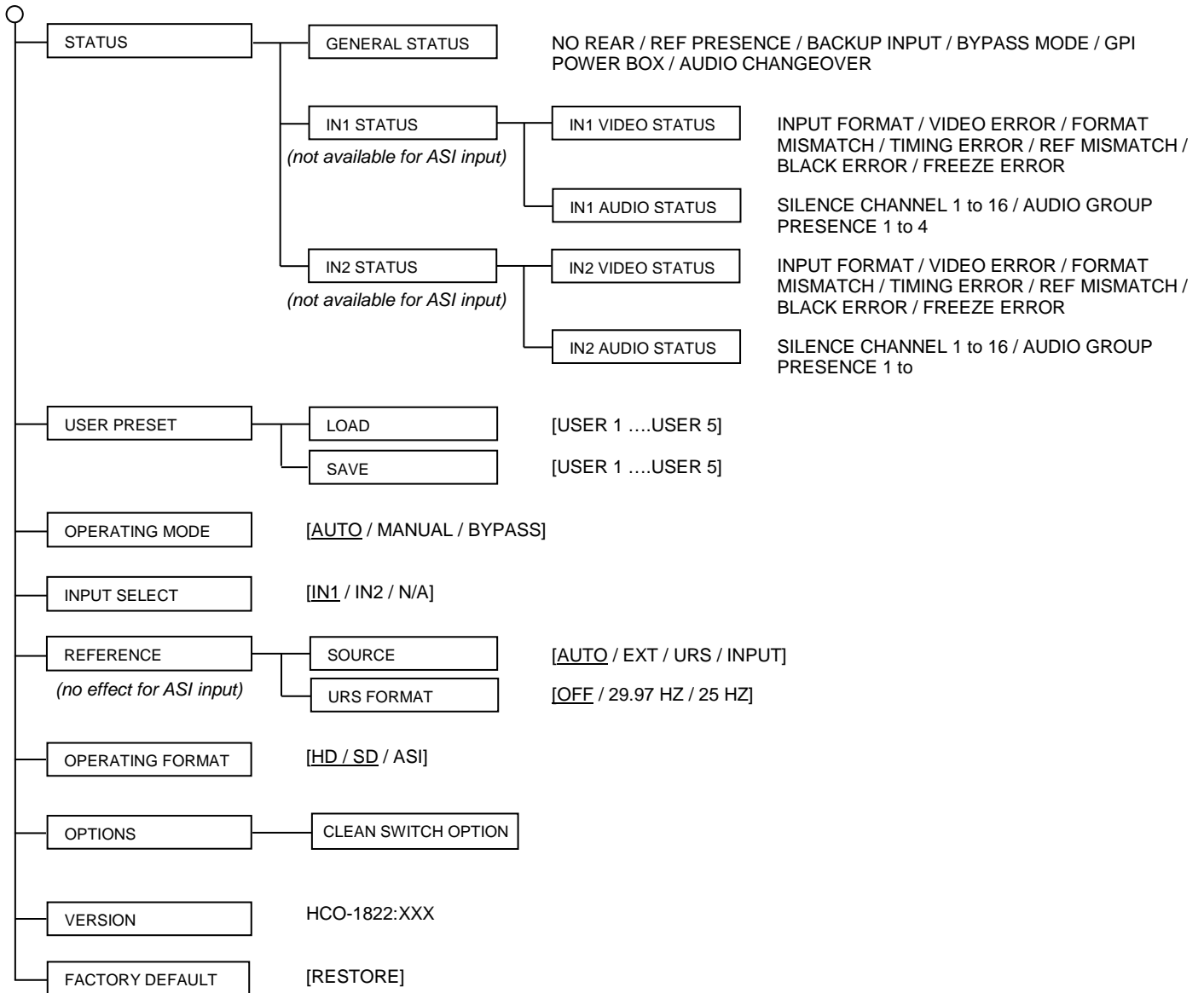

Sets all parameters shown above to their underlined default values.