

HCO-3931

12G/3G/HD Change Over with Clean Switch

User Manual

13-03066-010-AA-M00

2020-08-20

Document History

Document Number	Publication Date	Notes
13-03066-010-AA-M00	2020-08-20	Initial release

FCC Compliance

In order to comply with FCC/CFR47: Part 15 regulations, it is necessary to use high-quality, triple-screened Media or Monitor cable assemblies with integrated ferrite suppression at both ends.

Patent Information

This product may be protected by one or more patents. For further information, please visit:

www.grassvalley.com/patents/

Copyright and Trademark Notice

Grass Valley®, GV® and the Grass Valley logo are trademarks or registered trademarks of Grass Valley USA, LLC, or its affiliated companies in the United States and other jurisdictions. Grass Valley products listed in this document are trademarks or registered trademarks of Grass Valley USA, LLC or its affiliated companies, and other parties may also have trademark rights in other terms used herein.

Registered trademarks (®) are registered in one or more countries worldwide.

Copyright © 2020 Grass Valley Canada. All rights reserved. Specifications subject to change without notice.

Terms and Conditions

Please read the following terms and conditions carefully. By using HCO-3931 documentation, you agree to the following terms and conditions.

Grass Valley hereby grants permission and license to owners of HCO-3931 to use their product manuals for their own internal business use. Manuals for Grass Valley products may not be reproduced or transmitted in any form or by any means, electronic or mechanical, including photocopying and recording, for any purpose unless specifically authorized in writing by Grass Valley.

A Grass Valley manual may have been revised to reflect changes made to the product during its manufacturing life. Thus, different versions of a manual may exist for any given product. Care should be taken to ensure that one obtains the proper manual version for a specific product serial number.

Information in this document is subject to change without notice and does not represent a commitment on the part of Grass Valley.

Warranty information is available from the Legal Terms and Conditions section of Grass Valley's website (www.grassvalley.com).

Electrostatic Discharge (ESD) Protection

Electrostatic discharge occurs when electronic components are improperly handled and can result in intermittent failure or complete damage adversely affecting an electrical circuit. When you remove and replace any card from a frame always follow ESD-prevention procedures:

- Ensure that the frame is electrically connected to earth ground through the power cord or any other means if available.

- Wear an ESD wrist strap ensuring that it makes good skin contact. Connect the grounding clip to an *unpainted surface* of the chassis frame to safely ground unwanted ESD voltages. If no wrist strap is available, ground yourself by touching the *unpainted* metal part of the chassis.
- For safety, periodically check the resistance value of the antistatic strap, which should be between 1 and 10 megohms.
- When temporarily storing a card make sure it is placed in an ESD bag.
- Cards in an earth grounded metal frame or casing do not require any special ESD protection.

Protection contre les décharges électrostatiques (DES)

Une décharge électrostatique peut se produire lorsque des composants électroniques ne sont pas manipulés de manière adéquate, ce qui peut entraîner des défaillances intermittentes ou endommager irrémédiablement un circuit électrique. Au moment de remplacer une carte dans un châssis, prenez toujours les mesures de protection antistatique appropriées :

- Assurez-vous que le châssis est relié électriquement à la terre par le cordon d'alimentation ou tout autre moyen disponible.
- Portez un bracelet antistatique et assurez-vous qu'il est bien en contact avec la peau. Connectez la pince de masse à une *surface non peinte* du châssis pour détourner à la terre toute tension électrostatique indésirable. En l'absence de bracelet antistatique, déchargez l'électricité statique de votre corps en touchant une surface métallique *non peinte* du châssis.
- Pour plus de sécurité, vérifiez périodiquement la valeur de résistance du bracelet antistatique. Elle doit se situer entre 1 et 10 mégohms.
- Si vous devez mettre une carte de côté, assurez-vous de la ranger dans un sac protecteur antistatique.
- Les cartes qui sont reliées à un châssis ou boîtier métallique mis à la terre ne nécessitent pas de protection antistatique spéciale.

Environmental Information

European (CE) WEEE directive.



This symbol on the product(s) means that at the end of life disposal it should not be mixed with general waste.

Visit www.grassvalley.com for recycling information.

Grass Valley believes this environmental information to be correct but cannot guarantee its completeness or accuracy since it is based on data received from sources outside our company. All specifications are subject to change without notice.

If you have questions about Grass Valley environmental and social involvement (WEEE, RoHS, REACH, etc.), please contact us at environment@grassvalley.com.

Safety and EMC Standards

This equipment complies with the following standards:

Safety Standards



Information Technology Equipment - Safety Part 1

EN60950-1: 2006

Safety of Information Technology Equipment Including Electrical Business Equipment.

UL1419 (4th Edition)

Standard for Safety – Professional Video and Audio equipment (UL file number E193966)

EMC Standards

This unit conforms to the following standards:

EN55032:2015 (Class A)

Electromagnetic Compatibility of multimedia equipment - Emission requirements

EN61000-3-2:2014 (Class A)

Electromagnetic Compatibility - Limits for harmonic current emissions

EN61000-3-3:2013

Electromagnetic Compatibility - Limits of voltage changes, voltage fluctuations and flicker

EN55103-2:2009 (Environment E2)

Electromagnetic Compatibility, Product family standard for audio, video, audio-visual and entertainment lighting control apparatus for professional use. Part 2. Immunity

WARNING

This equipment is compliant with Class A of CISPR 32. In a residential environment this equipment may cause radio interference.

FCC / CFR 47:Part 15 (Class A)

Federal Communications Commission Rules Part 15, Subpart B

Caution to the user that changes or modifications not expressly approved by the party responsible for compliance could void the user's authority to operate the equipment.

Note: This equipment has been tested and found to comply with the limits for a Class A digital device, pursuant to part 15 of the FCC Rules. These limits are designed to provide reasonable protection against harmful interference when the equipment is operated in a commercial environment.

This equipment generates, uses, and can radiate radio frequency energy and, if not installed and used in accordance with the instruction manual, may cause harmful interference to radio communications.

Operation of this equipment in a residential area is likely to cause harmful interference in which case the user will be required to correct the interference at his own expense.

EMC Performance of Cables and Connectors

Grass Valley products are designed to meet or exceed the requirements of the appropriate European EMC standards. In order to achieve this performance in real installations it is essential to use cables and connectors with good EMC characteristics.

All signal connections (including remote control connections) shall be made with screened cables terminated in connectors having a metal shell. The cable screen shall have a large-area contact with the metal shell.

SIGNAL/DATA PORTS

For unconnected signal/data ports on the unit, fit shielding covers. For example, fit EMI blanking covers to SFP+ type ports; and fit 75 Ω RF terminators to BNC type ports.

COAXIAL CABLES

Coaxial cables connections (particularly serial digital video connections) shall be made with high-quality double-screened coaxial cables such as Belden 8281 or BBC type PSF1/2M, Belden 1694A (for 3Gbps) and Belden 4794R (for 12Gbps).

D-TYPE CONNECTORS

D-type connectors shall have metal shells making good RF contact with the cable screen. Connectors having “dimples” which improve the contact between the plug and socket shells, are recommended.

Table of Contents

1	HCO-3931 12G/3G/HD Change Over with Clean Switch and ALC	7
1.1	Introduction	7
1.2	Features	8
1.3	Block Diagram	9
1.4	Optional ALC License	10
1.5	Front Card-edge Interface	10
2	Installation	11
2.1	Installing the Rear Connector Panel	11
2.2	Installing the HCO-3931 Card	11
2.3	Rear Connector Panels	12
2.3.1	Image of the Rear Connector Panel	12
2.3.2	Summary of Rear Panel Connections	13
2.3.3	Details of Rear Panel Connections	14
3	Operation	17
3.1	Control options	17
3.2	Card-Edge Status LED	17
3.3	Local control using the Densité frame control panel	18
3.4	Remote control using iControl	19
3.4.1	The iControl graphic interface window	20
3.4.2	The Switch Control panel	22
3.4.3	The Probes Panel	26
3.4.4	The Switch Configuration panel	38
3.4.5	The Preview Configuration panel	41
3.4.6	The Timing panel	42
3.4.7	The Reference panel	43
3.4.8	The ALC panel	45
3.5	Test Panel	50
3.5.1	The Factory panel	52
3.6	Factory/Presets Panel	52
3.6.1	User Presets	53
3.6.2	Load Factory button	54
3.6.3	Profiles	54
3.7	Alarm Config Panel	57
3.8	Information Panel	60
4	Specifications	62
5	Contact Us	64
	Grass Valley Technical Support	64
	Corporate Head Office	64
	ANNEX 1 – HCO-3931 User Interface	65

1 HCO-3931 12G/3G/HD Change Over with Clean Switch and ALC

1.1 Introduction

The HCO-3931 from Grass Valley is a 4x1 12G/3G/HD SDI change-over that supports 16 channels of embedded audio and metadata. The card can perform a video and audio “clean and quiet switch” between sources. In the event of a power failure, the PGM signal is protected by a bypass circuit fitted on the rear panel, maintaining the integrity of the selected MAIN or BACKUP signals at the output, and it is fully controllable via GPI. Two rear panels are available with different bypass circuits, the HCO-3931-3DRP-H offers an active bypass that retains PGM signals for at least 48 hours while the HCO-3931-3TRP-HR uses 12G SDI rated bypass relays for extended protection.

At the core of the HCO-3931 versatility, a powerful automatic mode rules engine takes the guesswork out of establishing which input will be routed to the outputs. By simply selecting which signal analysis probes to enable, configuring the severity of each probe’s impact and optionally removing one or both Emergency inputs from the rules engine’s consideration, you effectively instruct the card how to compute the relative health of each input based on its weight and the probes statuses. This in turn enables you to effortlessly create a wide variety of failover mechanisms.

Change-over between inputs selection can also be performed manually, where any four sources can be selected from the Densité controller, the iControl/GV Orbit software, or simply by using a GPI. A GPI can be connected to an automation system or any simple GPI control panel. The GPI outputs give the status of the selected source, allowing tallies to be triggered.

The HCO-3931 provides two 12G/3G/HD outputs: Program (PGM) and Preview (PVW). Each output is available on two connectors (signal copy). The PVW output is user selectable to follow the main PGM output or any of four video inputs.

Grass Valley’s next generation 16-channel automatic loudness control (ALC) option, HCO-3931-OPT-ALC, can eliminate objectionable loudness variations between programs and commercials even better than with previous ALC versions, thanks to the addition of an independent dynamic stage consisting of a fully configurable input compressor and a new true peak output limiter with 1 ms buffer protection.

This new Densité card fully complements our line-up of 12G SDI products such as the HDA-3961 single/dual 12G DA with optional fiber connectivity, MDX-3901 12G 16 audio channel AES/MADI embedder/de-embedder, XIP- 3901 SDI/IP agile processing platform and our other Grass Valley products.

Based on the proven Densité modular framework of over 100 cards, the flexible, space-efficient HCO-3931 is a 3 RU card and is available with a two or three slots rear panel. With flexibility to configure up to 12 HCO-3931 change-over cards per Densité 3+ FR4 frame with the two-slot rear panel, the Densité platform scales to a density of twelve 12G SDI change-over cards in a 4 RU frame. This means space- and cost-efficient scaling for today and tomorrow.

The HCO-3931 is configured, controlled and monitored by GV Orbit from Grass Valley. It can also be configured and controlled from iControl systems.

The HCO-3931 targets emerging needs to provide changeover with clean switch and optional Automatic Loudness Control for single-stream 4K UHD signals using 12G SDI. The HCO-3931 is designed for a wide range of applications where bullet-proof mission critical signal distribution is required for OB trucks, production studios and playout facilities as shown here:

Configurable Probes

Video	
No Video	4
Video Reference Mismatch	4
Video Format Mismatch	4
Video Error	4
Black Detect	4
Freeze Detect	4
Audio	
Silence Detect (per channel)	4
Audio Presence (per group)	4

Bullet-proof On-air Protection

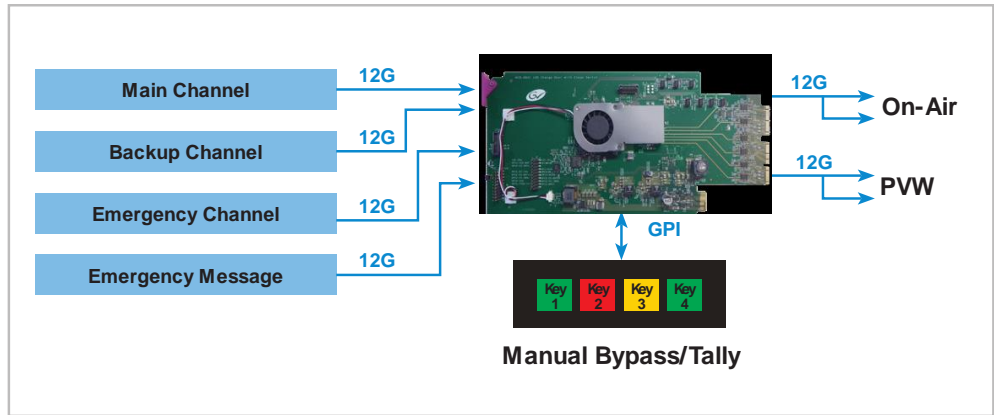

1.2 Features

- 12G/3G/HD SDI input/output
- Main, Backup and two Emergency inputs
- On-Air Program and Preview outputs with two connectors each (signal copy)
- Choice of external or frame URS reference input
- Audio/video de-glitcher to handle video hot switch on every input
- Clean and quiet switch function of video and 16 channels of audio on Program output
- Optional 16-channel Automatic Loudness Control
- GPIO – based inputs selection and tallies
- Electronic switching with two rear panels that maintain selected input upon power loss for Primary Main and Backup inputs:
 - HCO-3931-3TRP-HR triple rear with relay backups
 - HCO-3931-3DRP-H double rear with active bypass for a minimum of 48 hours of protection from a power loss
- Automatic change-over mode using internal signal analysis with configurable probes for all inputs
- Manual change-over by local frame controller, iControl/GV Orbit or GPI
- Alarm reporting to iControl/GV Orbit facility monitoring and control system
- iControl and GV Orbit for configuration, control and monitoring

1.2.1 Supported Video Formats

The HCO-3931 supports the following video formats.

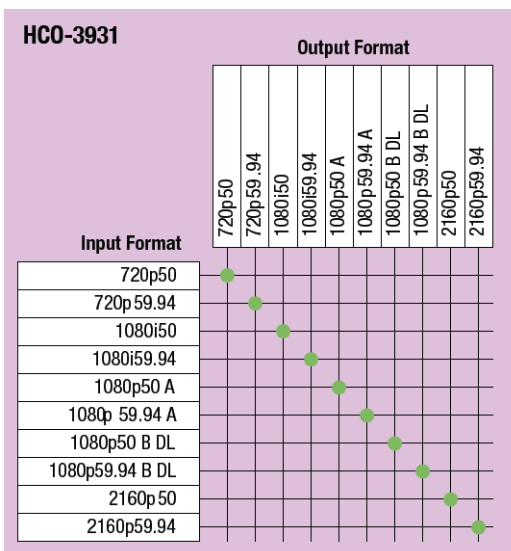

Figure 1 – Supported Video Formats

1.3 Block Diagram

The following block diagrams show the functionality of the HCO-3931.

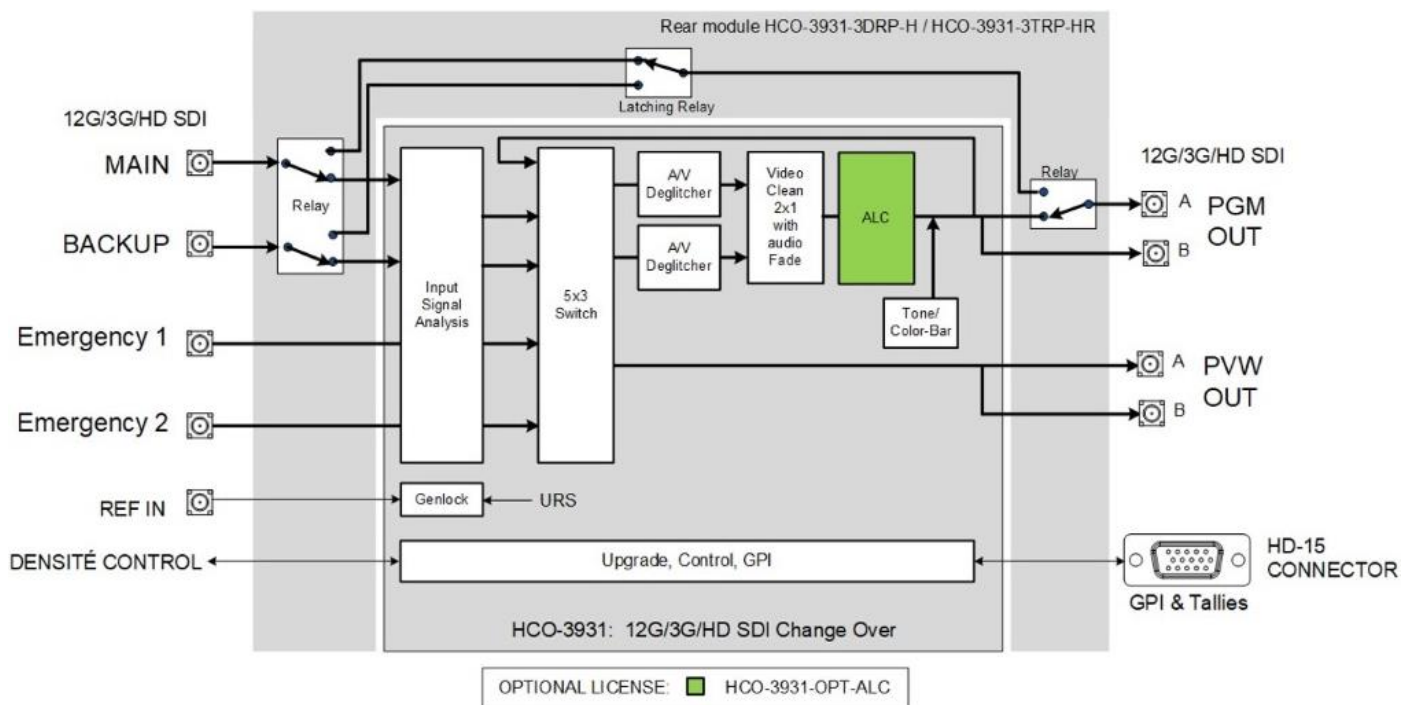

Figure 2 – Functional Block Diagram - HCO-3931

1.4 Optional ALC License

16-channel on-board Audio Loudness Control (ALC) processing can be enabled with the **HCO-3931-OPT-ALC** license.

1.5 Front Card-edge Interface

The front card-edge of the HCO-3931 incorporates two elements:

- Status LED (see section 3.2)
- Select Button (see section 3.3)

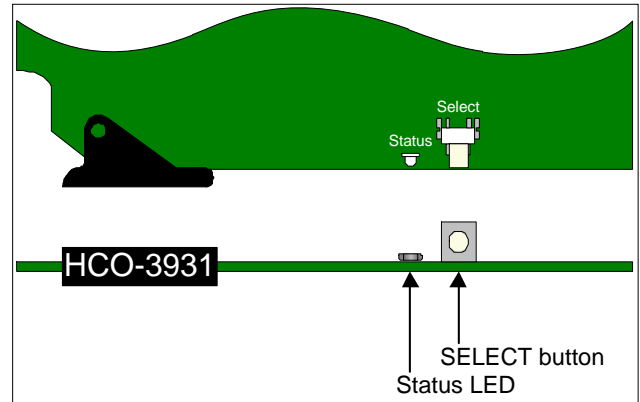

Figure 3 – Front card-edge layout

2 Installation

2.1 Installing the Rear Connector Panel

Each Grass Valley Densité-series card is associated with a rear connector panel, which must be installed in the Densité frame before the card can be inserted.

The HCO-3931 and its associated rear connector rear panel must be mounted in a Densité-3 or Densité-3+ series frame. The following rear connector panels are available:

- HCO-3931-3DRP-H: Double-width Densité-3 rear HD-BNC connectors. This active rear features electronic latching bypass relays.
- HCO-3931-3TRP-HR: Triple-width Densité-3 rear HD-BNC connectors. This passive rear features hardware-based latching bypass relays.

See 2.3 - Rear Connector Panels on page 12 for details about the signal connections available on this panel.

All cards and rear connector panels can be installed with the frame powered on. The card has connectors that plug into a mid-frame motherboard to distribute power and connect to the controller card, as well as a second connector that plugs directly into the rear connector panel for input and output.

To install the connector panel:



The rear connector panel must be installed with the card out of the frame.

1. If a card is installed in the slot for which the rear connector panel is being changed, it must be removed. Tilting the swivel handle on the front of the card to lever the connectors apart, and then use the handle to pull the card straight out of the slot.
2. Remove the existing rear connector panel (either blank or belonging to an existing card that is being changed) by releasing the captive screw(s) at the bottom (Densité3+ or Densité-3+FR4) or on the side (Densité-3+FR1) of the panel.
3. Position the new rear connector panel and secure it in place with the captive screw(s) at the bottom or on the side.

2.2 Installing the HCO-3931 Card

Once a matching rear connector panel is in place, install the HCO-3931 card as follows:

1. Open the front panel of the frame.
2. Slide the HCO-3931 card into the slot and push gently on the handle to seat the connectors.
 - When using a double-slot-width rear panel in a Densité-3+FR1 frame, the card should be inserted into the lower of the two slots.
 - When using a double-slot-width rear panel in a Densité-3+FR4 frame, the card should be inserted into the right-most of the two slots.

Inserting the card into the wrong slot will not damage the card, but the status LED on the card will flash red to indicate that there is no connection to the rear panel.

3. Close the front panel of the frame.

2.3 Rear Connector Panels

2.3.1 Image of the Rear Connector Panel

The rear connector panel is shown below.

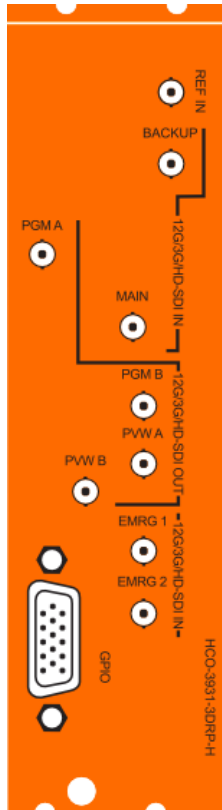

HCO-3931-3DRP-H – Double-width Densité-3 rear HD-DIN connectors. This active rear features an electronic-based latching bypass relay that provides 48 hours minimum retention from a power failure for the **PGM A** output signal with the **MAIN** or **BACKUP** input selection.

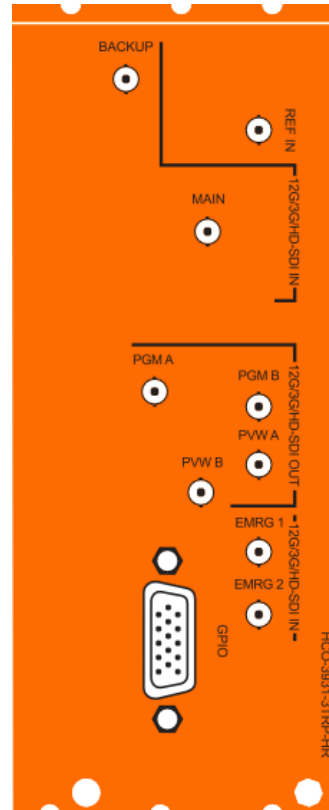

HCO-3931-3TRP-HR – Triple-width Densité-3 rear HD-DIN connectors. This passive rear features a hardware-based latching bypass relay that provides unlimited retention from a power failure for the **PGM A** output signal with the **MAIN** or **BACKUP** input selection.

Figure 4 – HCO-3931 Rear Panels

2.3.2 Summary of Rear Panel Connections

HCO-3931-3DRP-H				
HCO-3931-3TRP-HR				
Double-slot-width panel				◆
Triple-slot-width panel			◆	
Hardware Bypass Latching Relay (unlimited retention)			◆	
Electronic Bypass Latching Relay (minimum 48 hour retention)				◆
CONNECTORS			HD-BNC	HD-BNC
REF IN			◆	◆
12G/3G/HD IN	MAIN, BACKUP, EMERG 1, EMERG 2		◆	◆
12G/3G/HD OUT	PGM A, PGM B, PVW A, PVW B		◆	◆
CONNECTORS			HD15	HD15
GPIO			◆	◆

2.3.3 Details of Rear Panel Connections

12G/3G/HD IN – Serial Digital 12G/3G/HD input

Connect up to four serial digital video signals (**MAIN**, **BACKUP** and two emergency (**EMERG 1** & **EMERG 2**) inputs), conforming to the SMPTE ST 2082-10 standard for 12Gbps signals, SMPTE 292M standard for HD input signals, or SMPTE-425M for 3Gbps signals, to the BNCs labeled **12G/3G/HD SDI IN**. The HCO-3931 will automatically switch to the detected line format.

- **MAIN:** The main channel.
- **BACKUP:** The backup channel.
- **EMERG 1:** The emergency 1 channel.
- **EMERG 2:** The emergency 2 channel.

OUT – Serial Digital Video Outputs

The HCO-3931 provides four 12G/3G/HD SDI video outputs, conforming to the SMPTE ST 2082-10 standard for 12Gbps signals, SMPTE 292M standard for HD input signals, or SMPTE-425M for 3Gbps signals to the BNCs labeled **12G/3G/HD SDI OUT**.

- **PGM A, PGM B:** The main on-air video output. A latching bypass relay maintains the **PGM A** output signal with the **MAIN** or **BACKUP** input selection when there is a power failure.
- **PVW A, PVW B:** The preview output is user selectable to follow:
 - The main PGM output.
 - Any of the four video inputs.
 - Or the current failover input to the main program output

REF IN – Studio Reference Input

For external synchronization, connect a black studio reference signal to the BNC labeled **REF IN**.

Two reference signal formats are supported:

- For 59.94 fps: 525 (SMPTE 170M / 318M NTSC black burst)
- For 50 fps: 625 (ITU 624-4 PAL black burst)

GPIO Connector

The rear panels of the HCO-3931 include a GPIO interface that allows control of the switch process. When connecting the HCO-3931 to an automation system, be aware of the following:

1. The HCO-3931 card senses the presence of an external power supply voltage on the GPIO input. Any voltage greater than 1 V will silence the *GPI Connector Power* alarm, when this alarm is enabled.
2. GPIO inputs trigger on a momentary pulse. To be recognized without ambiguity, a GPIO trigger pulse should have a duration of at least 50 ms.

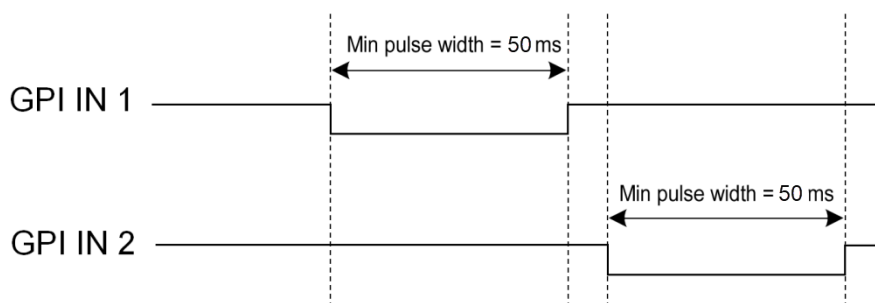

Figure 5 – GPIO input trigger pulse timing

The **GPIO** interface is implemented on an HD-15 connector. The pinout is as follows:



GPIO Label	Pin #
GPI-IN-MAIN	4
GPI-IN-BACKUP	9
GPI-IN-EMERGENCY1	3
GPI-IN-EMERGENCY2	8
GPI-IN-BYPASS	6
GPI-IN-AUTO	10
GPI-OUT-MAIN	1
GPI-OUT-BACKUP	7
GPI-OUT-EMERGENCY1	2
GPI-OUT-EMERGENCY2	12
GPI-OUT-BYPASS	11
GPI-OUT-AUTO	5
GPI-IN-PWR	15
GND	13,14

Note: You may find it convenient to purchase Grass Valley’s **NSH15M** HD15-to-terminal-block adapter, which provides easy access to the GPIO pins.

Using the GPIO interface

- Trigger the GPI-IN-MAIN, GPI-IN-BACKUP, GPI-IN-EMERGENCY1, or GPI-IN-EMERGENCY2 pin to select that input.
- Trigger the GPI-IN-AUTO or GPI-IN-BYPASS pin to select that mode.
- Read the GPI-OUT- MAIN, GPI-OUT- BACKUP, GPI-OUT- EMERGENCY1, GPI-OUT- EMERGENCY2 pins to identify which output is selected (“0” indicates selection).
- Read the GPI-OUT-AUTO and GPI-OUT-BYPASS pins to determine whether either of these modes is in operation (“0” indicates selection).

Note: When a **GPIO** input is triggered, the card switches to the input selected by the **GPIO** input. It may then change operating mode, depending on the **GPIO** input selected, the card’s switch configuration (see 3.4.4 - The Switch Configuration panel on page 38) and the card’s current operating mode (see 3.4.2 - The Switch Control panel on page 22).

Input	Card is in Auto mode	Card is in Bypass mode
GPI-IN-MAIN	Enter Manual Mode if so configured	Enter Manual Mode if so configured
GPI-IN-BACKUP	Enter Manual Mode if so configured	Enter Manual Mode if so configured
GPI-IN-EMERGENCY1	Enter Manual Mode if so configured or if this input is excluded from the automatic rules engine	Enter Manual mode
GPI-IN-EMERGENCY2	Enter Manual Mode if so configured or if this input is excluded from the automatic rules engine	Enter Manual mode

3 Operation

3.1 Control options

The HCO-3931 can be controlled in different ways:

- The local control panel and its push-buttons can be used to move through a menu of parameters and to adjust parameter values (see section 3.3).
- Grass Valley’s iControl system can be used to access the card’s operating parameters from a remote computer, using a convenient graphical user interface (GUI). (see section 3.4)

3.2 Card-Edge Status LED

The status monitor LED is located on the front card-edge of the HCO-3931, and is visible through the front access door of the DENSITÉ-3 frame. This multi-color LED indicates the status of the HCO-3931 by color, and by flashing/steady illumination.

The chart shows how the various error conditions that can be flagged on the HCO-3931 affect the LED status.

- If a cell is gray, the error condition cannot cause the LED to assume that status
- If more than one LED status is possible for a particular error condition, the status is configurable. See Section 3.7 - Alarm Config Panel on page 57for details.
- The factory default status is shown by a ✱

The LED will always show the most severe detected error status that it is configured to display, and in the chart error severity increases from left to right, with green representing no error/disabled, and flashing red the most severe error.

Error Condition	LED Status			
	Green	Yellow	Red	Flashing Red
No errors	✱			
No Video			✱	
Video error			✱	
Format Mismatch			✱	
Reference Mismatch			✱	
Input timing out of range			✱	
Black detection		✱		
Freeze detection		✱		
Audio presence group		✱		
Audio silence channel		✱		
SDI input used as reference			✱	
Ext Reference Presence			✱	
URS 29.97 Hz Presence	✱			
URS 25 Hz Presence	✱			
Reference Unlocked			✱	
MAIN not on Program	✱			
MAIN Impaired	✱			
BACKUP not on Program	✱			

Error Condition	LED Status			
	Green	Yellow	Red	Flashing Red
BACKUP Impaired	✘			
EMERGENCY1 not on Program	✘			
EMERGENCY1 impaired	✘			
EMERGENCY2 not on Program	✘			
EMERGENCY2 impaired	✘			
FPGA Engine Stopped				✘
Hardware Failure				✘
Rear Detection				✘
Card Fan				✘
Card Overheat				✘
GPIO Connector Power				✘

If the LED is Flashing Yellow, it means that the card is selected for local control using the Densité frame’s control panel. See Section 3.3 for details.

3.3 Local control using the Densité frame control panel

There are two types of local control panel:

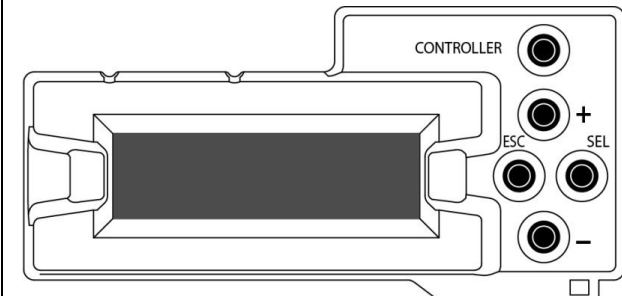
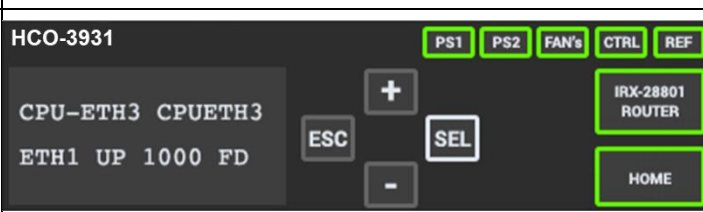
Panel type	Frame models	Appearance
Physical	Densité-2, Densité-3, Densité-3+FR1,	
Touch screen	Densité 3+FR4	

The local control panel is fastened to the front of the controller card.

- The physical panel is accessed by opening the front door of the frame.
- The touch screen panel is accessed through an aperture in the frame door.

The panel consists of a display capable of displaying two lines of text, each 16 characters in length, and four pushbuttons. The functionality of the pushbuttons is as follows:

[+] [-] Used for menu navigation and value modification

- [SEL] Gives access to the next menu level. When a parameter value is shown, pushing this button once enables modification of the value using the [+] and [-] buttons; a second push confirms the new value
- [ESC] Cancels the effect of parameter value changes that have not been confirmed; pushing [ESC] causes the parameter to revert to its former value.

Pushing [ESC] moves the user back up to the previous menu level. At the main menu, [ESC] does *not* exit the menu system. To exit, re-push the [SEL] button for the card being controlled.

If no controls are operated for 30 seconds, the controller reverts to its normal standby status, and the selected card's STATUS reverts to its normal operating mode.

To assign the local control panel to the HCO-3931:

- Physical Panel: Push the SELECT button on the HCO-3931 card edge (see Section 1.5).
- Touch-screen panel: In the home screen, touch the virtual button corresponding to this HCO-3931.

The STATUS LED on the HCO-3931 flashes yellow, and the touch-screen status shows yellow for the HCO-3931.

Use the control panel buttons to navigate through the menu, as described above.

The complete menu structure is shown in [ANNEX – HCO-3931 User Interface](#), beginning on page 65.

3.4 Remote control using iControl

The operation of the HCO-3931 may be controlled using Grass Valley's iControl system.

- This manual describes the control panels associated with the HCO-3931 and their use.
- Please consult the iControl User's Guide for information about setting up and operating iControl.

In iControl Navigator or iControl Websites, double-click on the HCO-3931 icon to open the control panel.

3.4.1 The iControl graphic interface window

The basic window structure for the HCO-3931 is shown in **Figure 6**. The window identification line gives the card type (HCO-3931) and the slot number where the card installed in its Densité frame.



Figure 6 – HCO-3931 iControl graphic interface window

There are four main sections in the window itself, identified in **Figure 6**:

1. The Status Icon area shows a series of seven icons that report the status of some card parameters. **Figure 7** shows the various forms that may appear; their meaning is described below.

Icon 1 – Control status

- A: Green - Remote Control through iControl
- B: Yellow - Local control using the menu

Icon 2 – Reference status

- A: Green - Locked to external reference
- B: Red - Reference is missing
- C: Grey - Using an SDI input as Reference

Icon 3 – Input MAIN status

- A: Green - Status OK
- B: Red – Error
- C: Grey – No analysis performed

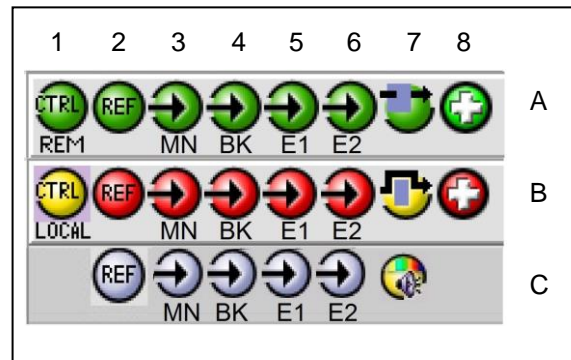

Figure 7 – Status Icons

Icon 4 – Input BACKUP status

- A: Green - Status OK
- B: Red – Error
- C: Grey – No analysis performed

Icon 5 – Input EMERGENCY1 status

- A: Green - Status OK
- B: Red – Error
- C: Grey – No analysis performed

Icon 6 – Input EMERGENCY2 status

- A: Green - Status OK
- B: Red – Error
- C: Grey – No analysis performed

Icon 7 – Operating Mode

- A: Bypass not active – switch operational
- B: Bypass activated
- C: Test Pattern

Icon 8 – Card Heath status

- A: Green - Fan OK and GPIO Power OK
- B: Red - Fan error or GPIO Power Error

When an icon shows an error state, a message describing the error will appear beneath the icons. If there is more than one error, they will cycle through the display.

- The icon whose status or error message is shown is highlighted with a mauve background
 - Move the cursor over an icon to display its status message. Error message cycling will resume when the cursor is no longer over an icon
2. The left-hand side of the panel contains a series of buttons that control the contents of the main window (section 4). Click on one to access the indicated controls. The selected button is highlighted (darker) and the main panel heading matched the button name.
 3. At the bottom are the controls for the User presets.
 4. This section contains the main operating controls and displays for managing the HCO-3931's feature set. The contents are selected by clicking a button on the left-hand side of the screen.

The left side of the window, containing sections 2 and 3, can be hidden or revealed by clicking the arrow icon at the center of the left side border.

Each of the panels associated with the groups accessed from the buttons in Section 2, and shown in Section 4, is described individually in the following sections.

3.4.2 The Switch Control panel

The HCO-3931 has three modes of switch operation, selected from the buttons in the Switch Control panel.

Clean switching is enabled by selecting the **Clean Switch Enabled** checkbox. This activates the Timing panel, where the clean switch timing requirements can be set up. See 3.4.6 - The Timing panel on page 42

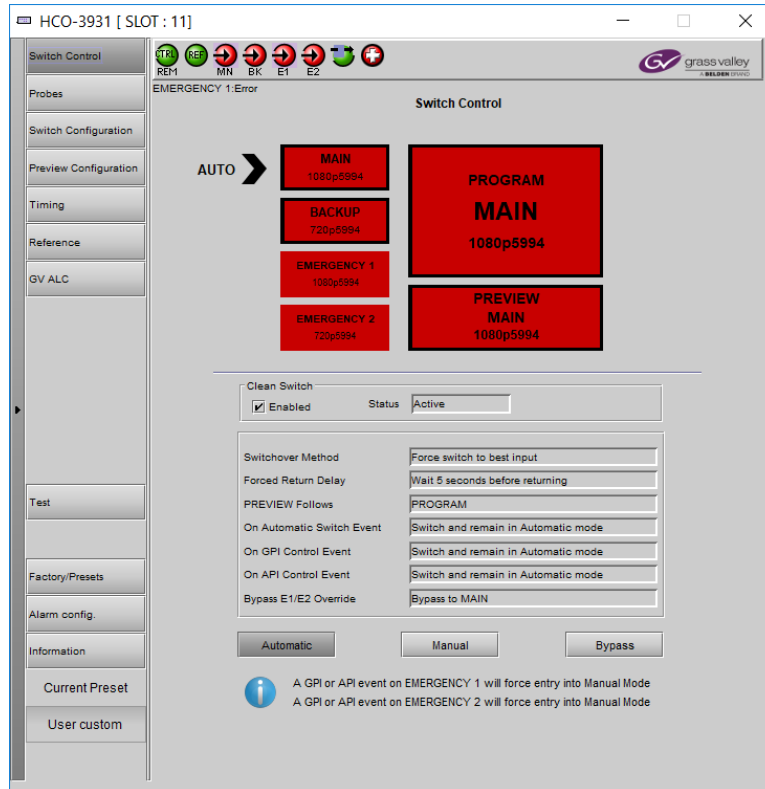

Figure 8 – Switch Control panel

3.4.2.1 Automatic switch

Auto switch uses signal analysis probes to determine whether the best input to be selected.

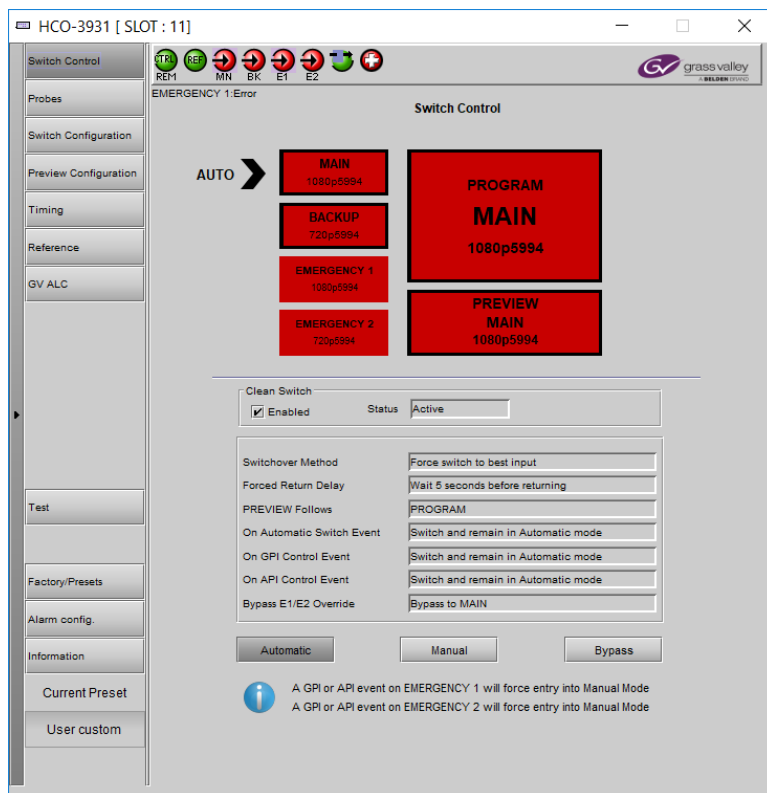

Figure 9 – Automatic Switch Mode

Click the Automatic mode button to set this mode. The automatic operating mode parameters are shown above.

3.4.2.2 Manual switch

Manually switches the HCO-3931 output between the three possible sources: **MAIN**, **BACKUP**, **EMERGENCY 1**, and **EMERGENCY 2**.

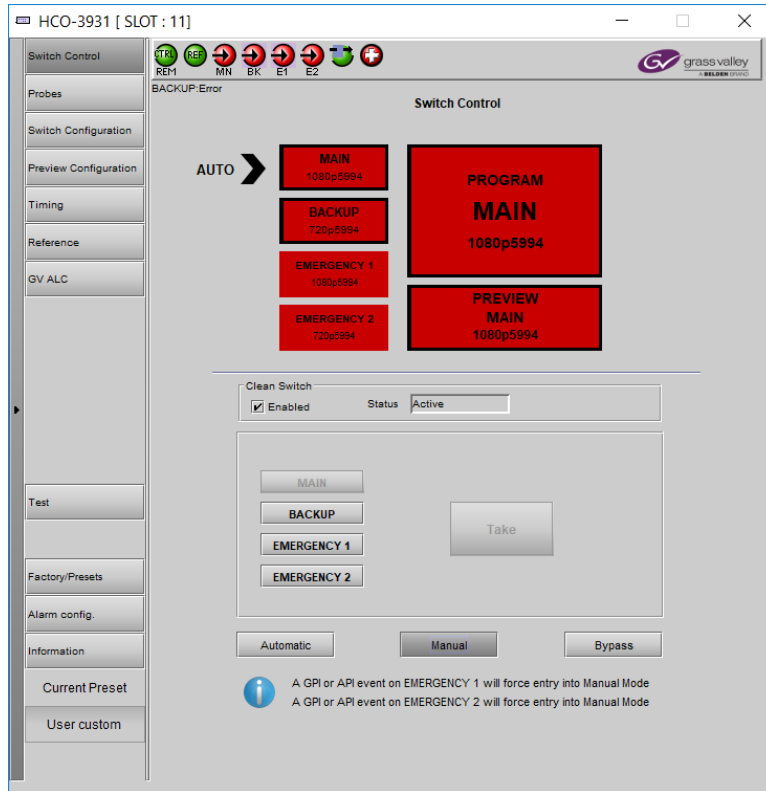

Figure 10 – Manual Switch Mode

Click the **Manual** button. The four possible sources are shown on the left. The graphic on the page shows which input is currently active.

1. Click one of the available sources **MAIN**, **BACKUP**, **EMERGENCY 1**, and **EMERGENCY 2** for a different source. The selection shows green, and the Take button is activated, appearing red.
2. A countdown (from 10 seconds) underneath the Take button shows how long the Take button will remain active before it times out.
3. Click the Take button while it is active to switch the HCO-3931 output over to the other source.

3.4.2.3 Bypass Mode

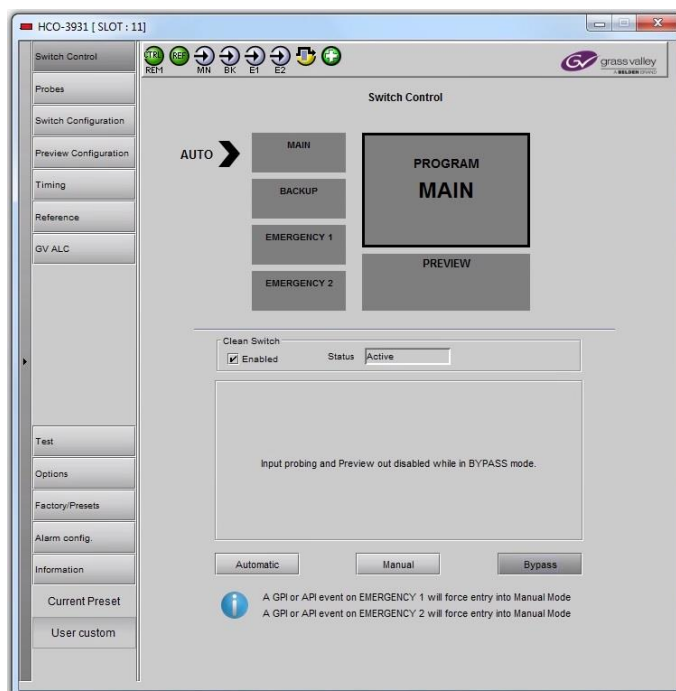

Figure 11 – Bypass Switch Mode

Bypass triggers circuitry on the rear panel to connect the **MAIN** or **BACKUP** input directly to the **PGM A** output. When the HCO-3931 is in Bypass:

- The currently selected input (Input **MAIN** or **BACKUP** only) is connected to **PGM A** output.
- The PVW (preview) outputs are disabled
- There is no video / audio / metadata analysis

The bypassed HCO-3931 card is electrically disconnected from the Densité signal system, and can be removed from the frame with no discontinuity in the signal path.

NOTE: Grass Valley recommends that you set the HCO-3931 in *BYPASS* mode before removing it from the Densité frame to ensure no disruption in the signal when the card is removed and reinserted.

The Operating Mode can also be selected using the Menu from the local control panel (see Section 3.3), and through the GPIO interface on the rear connector panel (see Section 2.3)

3.4.3 The Probes Panel

The HCO-3931 continuously monitors the condition and status of the input signals it is processing. The information is used to decide whether the input must be switched in Auto mode. It is also used to flag the status of the card in the iControl system. A range of parameters are probed and you assign a weight (**High**, **Low**, or **None**) to each parameter, for each input. This weighting informs the card's decision logic to automatically switch an input.

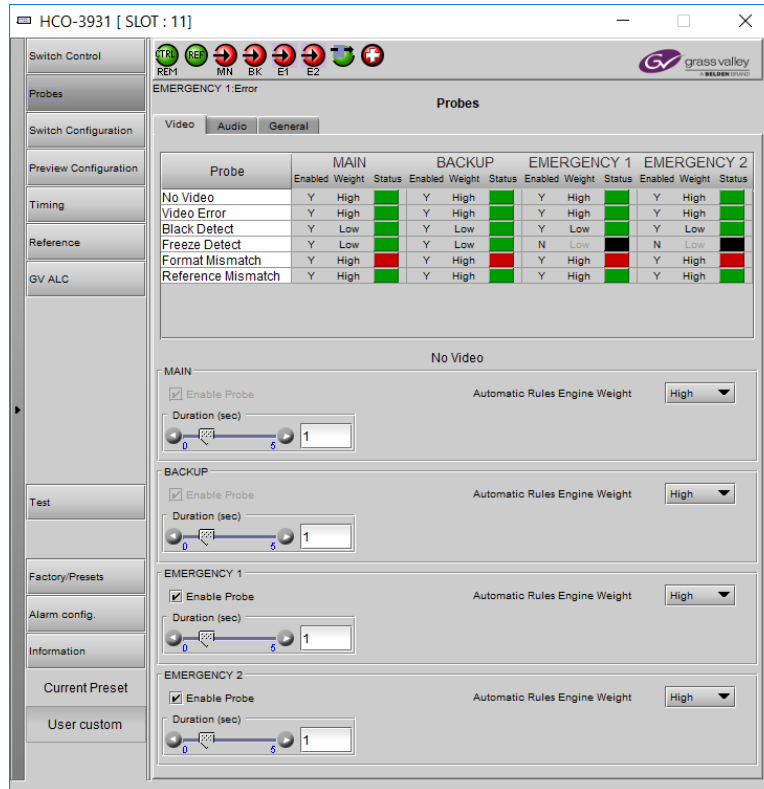

Figure 12 – Probes panel, Video Tab, No Video

Property	Description
Probe	<p>This table shows the current configuration summary and the probe statuses for all probes. Click one of the following probes to configure it. According to the probe you have clicked on, the configuration parameters are shown for it on the lower half of the screen.</p> <p>No Video: This probe detects an absence of video signal on an input. See 3.4.3.1 - Video tab – No Video Probe on page 29.</p> <p>Video Error: This probe detects that a video signal is present, but contains TRS video errors. See 3.4.3.2 - Video tab – Video Error Probe on page 30.</p> <p>Black Detect: This probe detects the presence of a continuous black signal for a period of time; the probe triggers when the time duration criterion has been satisfied. See 3.4.3.3 - Video tab – Black Detect Probe on page 31</p> <p>Freeze Detect: This probe detects the presence of a signal freeze (for example, there is no change in content) for a period of time; the error is flagged only when the time duration criterion has been satisfied. See 3.4.3.4 - Video tab – Freeze Detect Probe on page 32.</p> <p>Format Mismatch: You set an expected format for each input using the pulldown in the control panel. This probe compares this with the actual format detected at the input, and the probe triggers if they do not match. See 3.4.3.5 - Video tab – Format Mismatch Probe on page 33.</p> <p>Reference Mismatch: This probe detects if there is a difference between the input video format's frame rate and the reference format's frame rate. See 3.4.3.6 - Video tab – Reference Mismatch Probe on page 34</p> <p>Audio Grp 1, 2, 3, 4: This probe detects the absence of audio in the named group. See 3.4.3.7 - Audio tab – Audio Grp 1, 2, 3, 4 Probe on page 35.</p> <p>Silence CH1 – 16: This probe flags the continuous absence of sound level in the specified audio channel for a specified duration. See 3.4.3.8 - Audio tab – Silence CH1 – 16 Probe on page 36.</p>
Enabled	Shows if the probe is enabled. When Enable Probe is set below, this shows the status Y . When Enable Probe is deselected below, this shows the status N . Note that depending on the active Switch Configuration, some probes are always enabled for some inputs, and cannot be unchecked.
Weight	Shows the weight assigned to the probe, to determine the extent to which it contributes to the automatic switch decision. High: highest significance. Low: lower significance. None: not used in the switch decision process, but will generate alarms to the iControl system
Status	Shows the current probe's status according to the probe's configuration set below: Green: The probe has detected normal operation. Red: The probe has detected abnormal operation. Black: The probe is disabled. Grey: Analysis cannot be performed (for example, Silence cannot be detected for missing audio groups) The LED color is not configurable.
MAIN	This is the signal connected to the MAIN input on the rear panel.
BACKUP	This is the signal connected to the BACKUP input on the rear panel.
EMERGENCY 1	This is the signal connected to the EMER 1 input on the rear panel.
EMERGENCY 2	This is the signal connected to the EMER 2 input on the rear panel.

Property	Description
Enable Probe	<p>Set to enable the probe so that it will contribute to the automatic switch decision process based on the <i>Automatic Rules Engine Weight</i> you have assigned to it (Weight = High, Low). Certain probes cannot be disabled.</p> <p>A probe that is enabled:</p> <ul style="list-style-type: none"> • Is reflected in the device status as reported to iControl (Weight has no bearing on this). • Only becomes active after: <ul style="list-style-type: none"> ○ A signal outage time delay (Duration or Set Duration). ○ A threshold level has been met (Threshold). ○ A signal restored time delay (Clear Duration).
Duration Set Duration	Set the probe's outage time required to trigger the probe to filter transients. See also the description for the specific probe for more information.
Threshold	Set the probe's threshold level has to be met to trigger the probe to filter transients. See also the description for the specific probe for more information.
Clear Duration	Set the amount of time that the signal must be restored before the probe is reset. See also the description for the specific probe for more information.

3.4.3.1 Video tab – No Video Probe

The No Video probe detects an absence of video signal on an input for a period of time; the probe is triggered when the time duration criterion has been satisfied. This probe is always Enabled for **MAIN** and **BACKUP**, and the level set to **High**, **Low**, or **None**. The factory default value is **High**.

This probe is always Enabled for **MAIN** and **BACKUP**, and the level set to **High**, **Low**, or **None**. The factory default value is **High**.

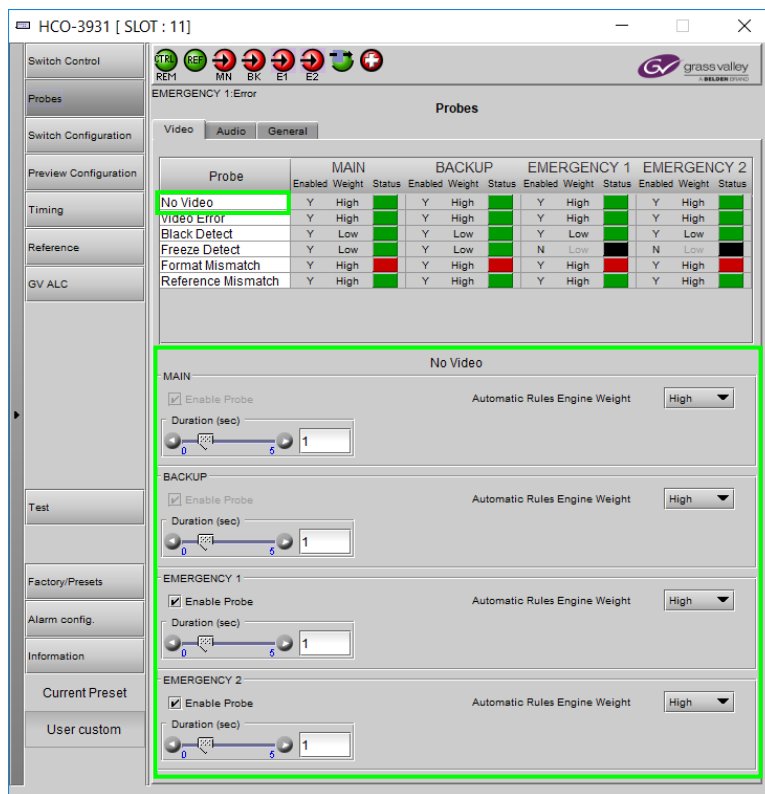

Figure 13 – Probes panel, Video Tab, No Video Probe

Use the slider to set the duration for which the outage must continuously exist before the probe is triggered. The nominal range of durations is 0 to 5 seconds.

In AUTO MODE, if switching is not desired when Input **MAIN** changes video format, set the Duration to at least 0.5 seconds

See also 3.4.3 - The Probes Panel on page 26 for more information about the configuration parameters.

3.4.3.2 Video tab – Video Error Probe

Video Error: This probe detects that a video signal is present, but contains TRS video errors. The probe integrates errors over windows of 1s but triggers as soon as the threshold is encountered.

This probe is always Enabled for **MAIN** and **BACKUP**, and the level set to **High**, **Low**, or **None**. The factory default value is **High**.

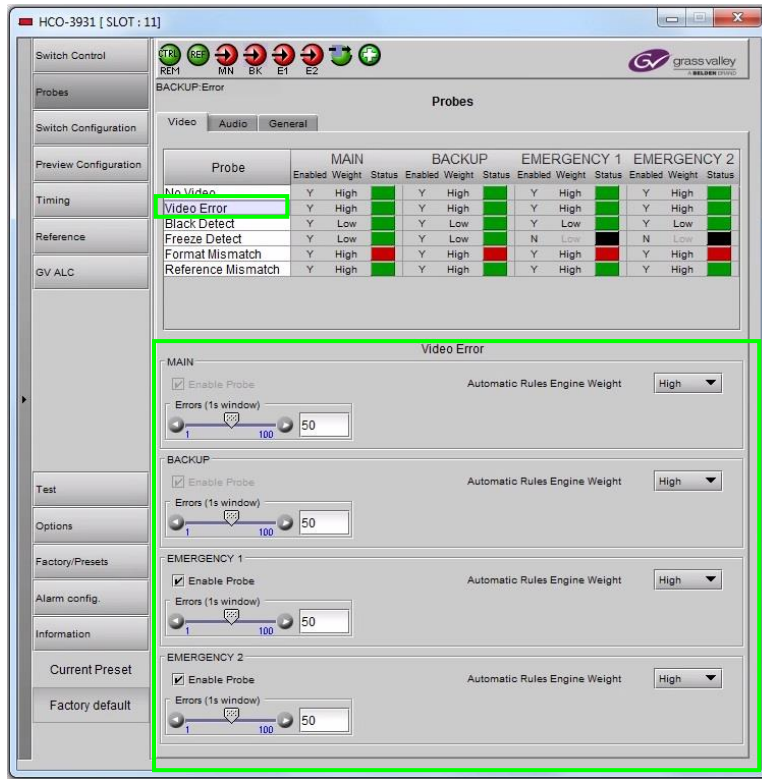

Figure 14 – Probes panel, Video Tab, Video Error Probe

Use the slider to set the number of signal errors allowed over a 1s window before the probe is triggered.

See also 3.4.3 - The Probes Panel on page 26 for more information about the configuration parameters.

3.4.3.3 Video tab – Black Detect Probe

This error detects the presence of a continuous black signal for a period of time; the probe is triggered when the time duration criterion and luminance threshold have been satisfied.



Figure 15 – Probes panel, Video Tab, Black Detect Probe

Property	Description
Threshold (mV)	Sets the signal level below which Black will be considered to have been detected.
Set Duration (sec)	Sets the time interval over which Black must be continuously detected before the error is flagged.
Clear Duration (sec)	Sets the time interval during which a non-black signal must be continuously detected before a previously-flagged Black error will be cleared.

See also 3.4.3 - The Probes Panel on page 26 for more information about the configuration parameters.

3.4.3.4 Video tab – Freeze Detect Probe

This probe detects the presence of a signal freeze (for example, there is no change in content) for a period of time; the error is flagged only when the time duration criterion has been satisfied.



Figure 16 – Probes panel, Video Tab, Freeze Detect Probe

Property	Description
Threshold	Sets a sensitivity level for detection that will allow minor level changes due to noise, but will detect a lack of change in the picture content. The value (in the range 0 to 15) is arbitrary, and may need to be set by trial and error depending on the signal characteristics. A higher threshold value will be more tolerant to video noise than a lower value and the card may not be able to detect the freeze in presence of changing pixels. If you want to detect a pure digital video freeze, you can use the value zero. Otherwise, the threshold should be increased until a consistent freeze is detected.
Set Duration (sec)	Sets the time interval over which a freeze must be continuously detected before the error is flagged. The nominal range of durations is 1 to 90 seconds.
Clear Duration (sec)	Sets the time interval during which an active signal must be continuously detected before a previously-flagged Freeze error will be cleared.

See also 3.4.3 - The Probes Panel on page 26 for more information about the configuration parameters.

3.4.3.5 Video tab – Format Mismatch Probe

You set an expected format for each input using the pulldown in this control panel. This probe compares this with the actual format detected at the input, and the probe triggers if they do not match.

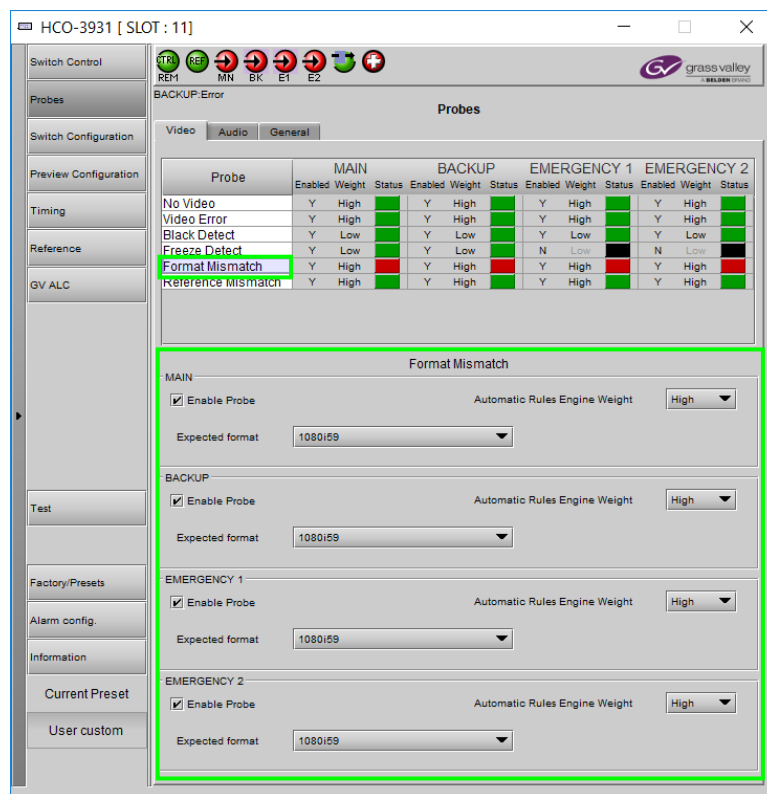

Figure 17 – Probes panel, Video Tab, Format Mismatch Probe

Property	Description
Expected format	Set the expected format for each input.

See also 3.4.3 - The Probes Panel on page 26 for more information about the configuration parameters.

3.4.3.6 Video tab – Reference Mismatch Probe

This probe detects if there is a difference between the input video format's frame rate and the reference format's frame rate.

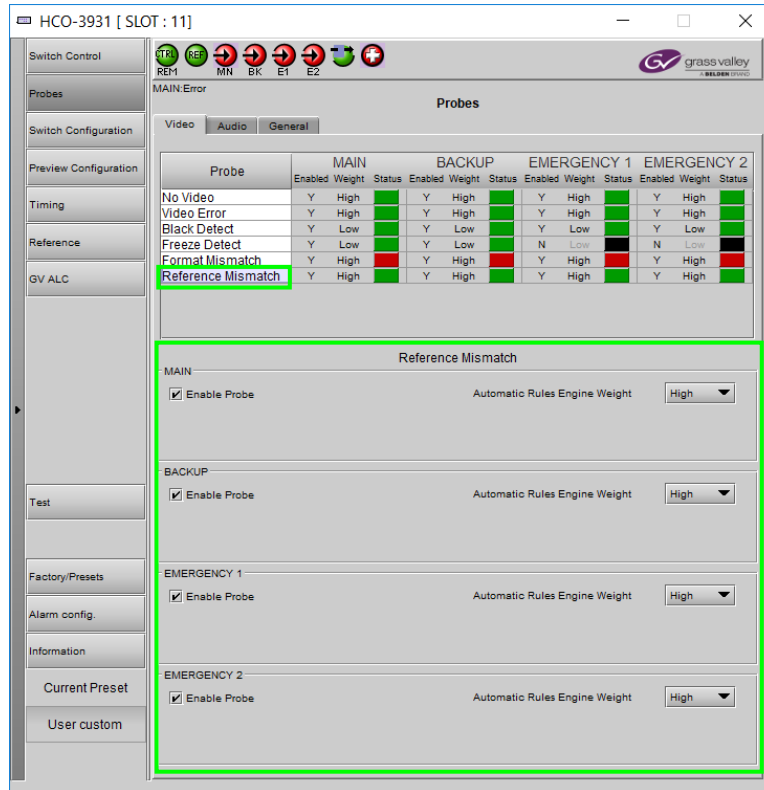

Figure 18 – Probes panel, Video Tab, Reference Mismatch Probe

See also 3.4.3 - The Probes Panel on page 26 for more information about the configuration parameters.

3.4.3.7 Audio tab – Audio Grp 1, 2, 3, 4 Probe

This probe detects the absence of audio in the named group.

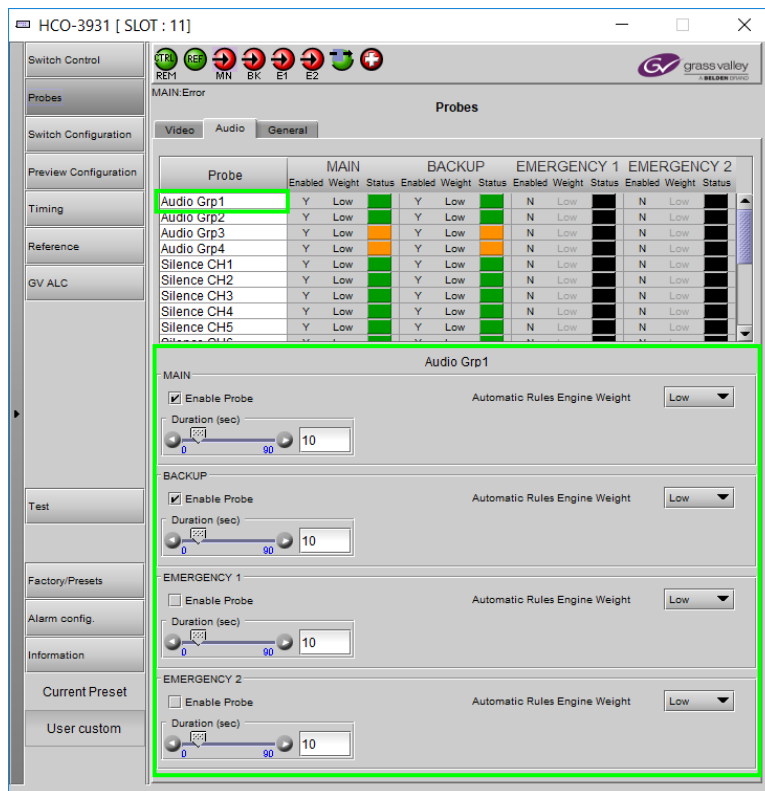

Figure 19 – Probes panel, Audio Tab, Audio Grp Probe

Property	Description
Duration (sec)	Set the time interval over which loss of audio must be continuously detected before the error is flagged.

See also 3.4.3 - The Probes Panel on page 26 for more information about the configuration parameters.

3.4.3.8 Audio tab – Silence CH1 – 16 Probe

This probe flags the continuous absence of sound level in the specified audio channel for a specified duration.



Figure 20 – Probes panel, Audio Tab, Silence CH Probe

Property	Description
Threshold (dB)	Sets the signal level below which silence will be considered to have been detected.
Duration (sec)	Sets the time interval over which silence must be continuously detected before the error is flagged.

Note: This probe works with PCM audio only.

See also 3.4.3 - The Probes Panel on page 26 for more information about the configuration parameters.

3.4.3.9 General tab

This panel:

- Is used to copy the probe setting from one input to another input to allow you to quickly configure the card.
- Can allow raising an alarm or change the Card Health status if the card detects an absence of power at the **GPIO** connector.

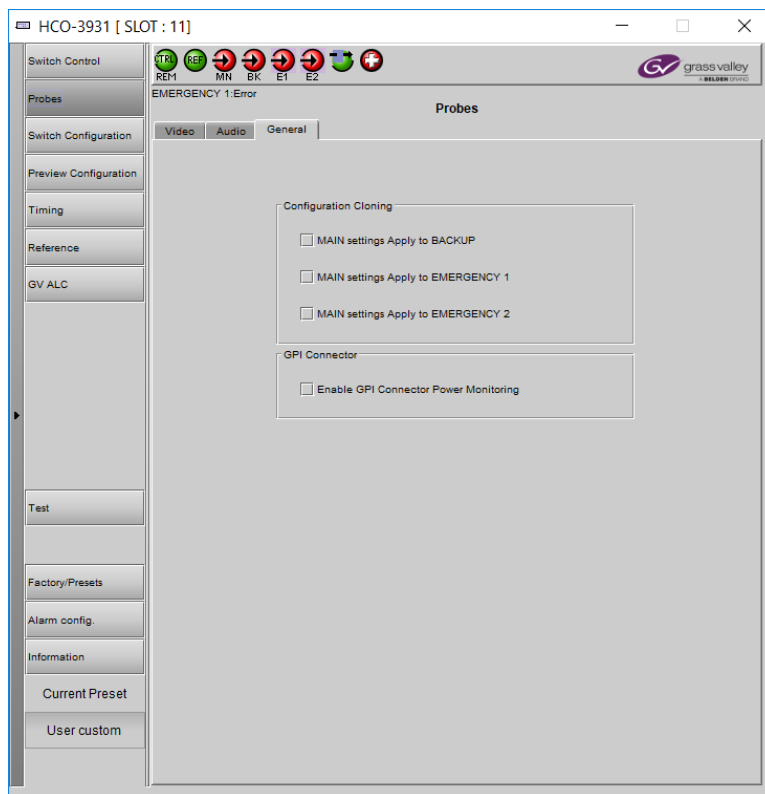

Figure 21 – Probes panel, General Tab

Property	Description
Configuration Cloning	<p>Click a checkbox to force all probe parameters for an input to adopt the probe parameters set for the MAIN input.</p> <ul style="list-style-type: none"> • When set, only one set of alarm parameters is displayed for both inputs. • When deselected, the alarm parameters for Input BACKUP revert to their previous values, for example, as they were before the checkbox was selected. <p>MAIN settings Apply to BACKUP: Make all BACKUP probe parameters match those of the configuration for MAIN.</p> <p>MAIN settings Apply to EMERGENCY 1: Make all EMERGENCY 1 probe parameters match those of the configuration for MAIN.</p> <p>MAIN settings Apply to EMERGENCY 2: Make all EMERGENCY 2 probe parameters match those of the configuration for MAIN.</p>
GPI Connector	<p>The HCO-3931 card senses the presence of an external power supply voltage on the GPIO input. When Enable GPI Connector Power Monitoring is set, any voltage greater than 1 V will silence the <i>GPI Connector Power</i> alarm, when this alarm is enabled. This alarm, when activated, indicates that the external GPIO system may no longer be capable of correctly interacting with the card due to power loss.</p>

3.4.4 The Switch Configuration panel

The rules engine applies the fixed weight associated with the selected level to establish which input must be selected for the program output, also taking into consideration the relative weight of the inputs used by the engine.

Along with the probes configuration settings, the switch configuration panel allows configuring the rules that the automatic mode engine uses to establish when to switch PROGRAM to a different input, as well as which input to use.

The automatic mode rules engine uses a weighting scheme to compute an input's "health" and determine the best input to use. In this scheme:

- Not all inputs are equal. For example, MAIN has a weight of 100 whereas EMERGENCY 2 has a weight of 50.
- The measured impairment of each input is factored into the evaluation. For example, an input with no impairment has a weight of 1, whereas an input with a high level of impairment has a weight of 0.2.

The following weighting table shows the permutations of this weighting scheme.

	Input	MAIN	BACKUP	EMERGENCY1	EMERGENCY2
	Weight	100	75	60	50
Impairment	Weight				
None	1	100	75	60	50
Low	0.45	45	33.75	27	22.5
High	0.2	20	15	12	10

Figure 22 – Auto-Switch Weighting Table

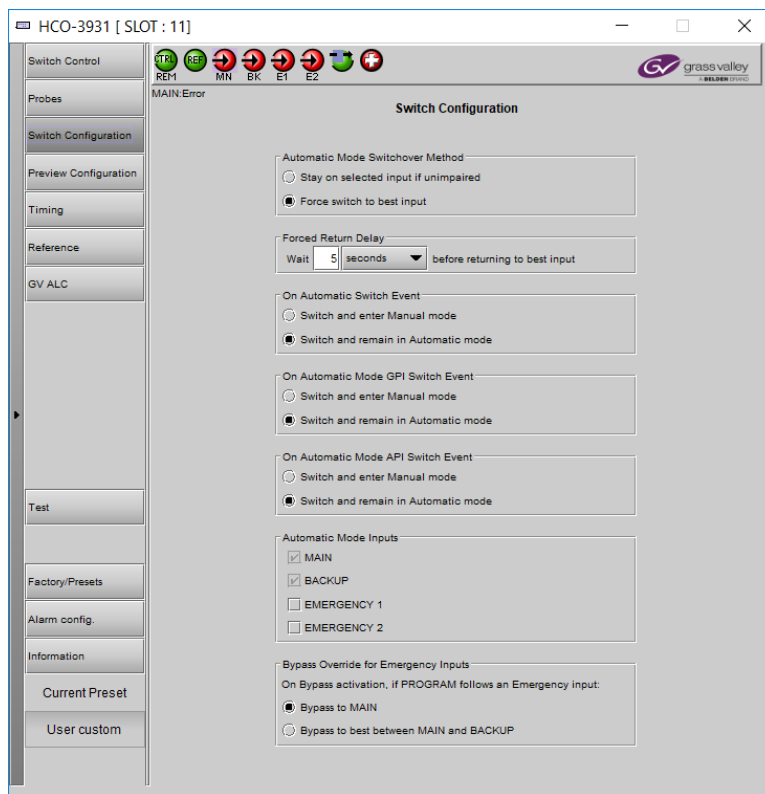

Figure 23 – Switch Configuration panel

Property	Description
Automatic Mode Switchover Method	Set how the automatic mode behaves. Stay on selected input if unimpaired: in this mode, the engine will switch PROGRAM to a different input only when the currently selected input’s health worsens. No switch will occur to a higher ranked input (for example, MAIN) if the currently selected input (for example, BACKUP) is not impaired. Force switch to best input: in this mode, the engine reconsiders the input to route to PROGRAM every time the health status of an input changes. Switching occurs after a configurable forced returned delay.
Forced Return Delay	Configure a delay that applies when the automatic switchover rules engine operates in Force switch to best input mode. Default: 5 seconds
On Automatic Switch Event	Set the behavior when an automatic switchover is triggered while the card is in automatic mode. Switch and enter Manual mode: Following an automatic switchover, the card enters manual mode. This is useful in situations where a switchover decision may be sign of serious problems in the upstream chain, and you want to have manual control until the situation is resolved. Switch and remain in Automatic mode: Following an automatic switchover, the card remains in automatic mode.
On Automatic Mode GPI Switch Event	Set the behavior when a switchover is triggered from a GPI input while the card is in automatic mode. See <i>GPI Connector</i> on page 15. Switch and enter Manual mode: Following a switchover caused by a GPIO input, the card enters manual mode. Switch and remain in Automatic mode: Following a switchover caused by a GPIO input, the card remains in automatic mode.

Property	Description
Automatic Mode API Switch Event	<p>Set the behavior when a switchover is triggered through an API-based switching event (RESTfull Densité command received from a third party system) while the card is in automatic mode.</p> <p>Switch and enter Manual mode: Following a switchover caused by an API, the card enters manual mode.</p> <p>Switch and remain in Automatic mode: Following a switchover caused by an API, the card remains in automatic mode.</p>
Automatic Mode Inputs	<p>When the card is in the Automatic mode, enable the inputs that can be used by automatic operation: MAIN, BACKUP, EMERGENCY 1, and EMERGENCY 2.</p> <p>MAIN and BACKUP are always taken into consideration, that is they cannot be ignored by the rules engine.</p> <p>You can individually remove EMERGENCY 1 and EMERGENCY 2 from the rules engine, so they will not be considered for an automatic switchover. Any input can still be manually forced.</p>
Bypass Override for Emergency Inputs	<p>When the Bypass mode is activated (3.4.2.2 - Manual switch on page 24), set the behavior for the card.</p> <p>Bypass to MAIN: The input at MAIN is sent to the PGM A output.</p> <p>Bypass to best between MAIN and BACKUP: Either input MAIN or BACKUP, with the least impairment, is sent to the PGM A output.</p>

3.4.5 The Preview Configuration panel

Set the source for the preview outputs **PVW A** and **PVW B**.

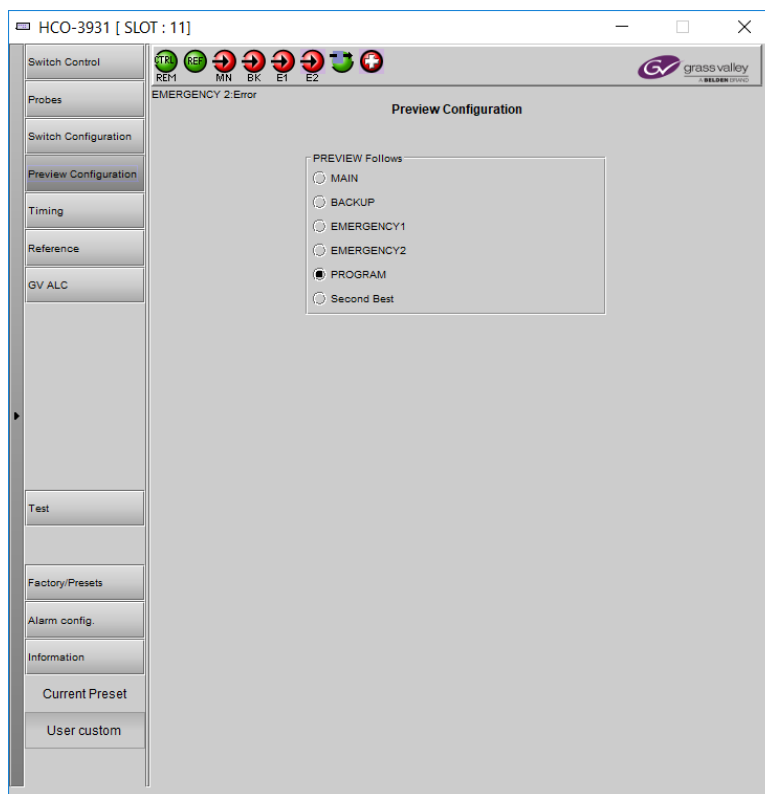

Figure 24 – Preview Configuration panel

Property	Description
Preview Follows	<p>Set the source for the preview outputs PVW A and PVW B:</p> <p>MAIN: The preview outputs PVW A and PVW B show the signal at the card’s MAIN input.</p> <p>BACKUP: The preview outputs PVW A and PVW B show the signal at the card’s BACKUP input.</p> <p>EMERGENCY 1: The preview outputs PVW A and PVW B show the signal at the card’s EMERG 1 input.</p> <p>EMERGENCY 2: The preview outputs PVW A and PVW B show the signal at the card’s EMERG 2 input.</p> <p>PROGRAM: The preview outputs PVW A and PVW B show the signal at the card’s PGM A / B outputs.</p> <p>Second Best: The preview outputs PVW A and PVW B show the signal for the input with the current failover input to the main program output. That is, the second best impairment rating according in real time according to the card’s automatic switchover calculation based on Figure 22 on page 38.</p>

Note that the preview outputs always use the SDI input being observed as the reference source.

3.4.6 The Timing panel

NOTE: this panel is only available when the **Clean Switch Enable** checkbox is selected in the Switch panel (see section 3.4.2 - The Switch Control panel on page 22).

The PGM output timing, with respect to a detected reference, is programmable from -2 to +2 video lines with programmable increments of -2, -1, -1/2, 0, +1/2, +1, or +2 lines.

In order for no input timing errors to occur, the input source must be synchronized and phased within a pre-defined 2 video line window. The start and end of the window precedes the user-programmed card output timing. To compensate for the card's minimum processing delay, a 500 pixels dead zone area is at the end of this window. The recommended practice is to set the output timing so that the input timing falls in the middle area of the 2 line buffer.

The timing panel graphic shows the inputs (**MAIN, BACKUP, EMERGENCY 1, EMERGENCY 2**) and the output (**PROGRAM**) phase relationship (represented by a black diamond marker) with respect to the card's reference (reperesented by a yellow verticle bar). If the measured input timing remains within the supported input range window (within the green REF area), the timing measurement will remain green. If not, the measurement will turn red (take corrective actions such as changing the **PROGRAM Timing** setting).

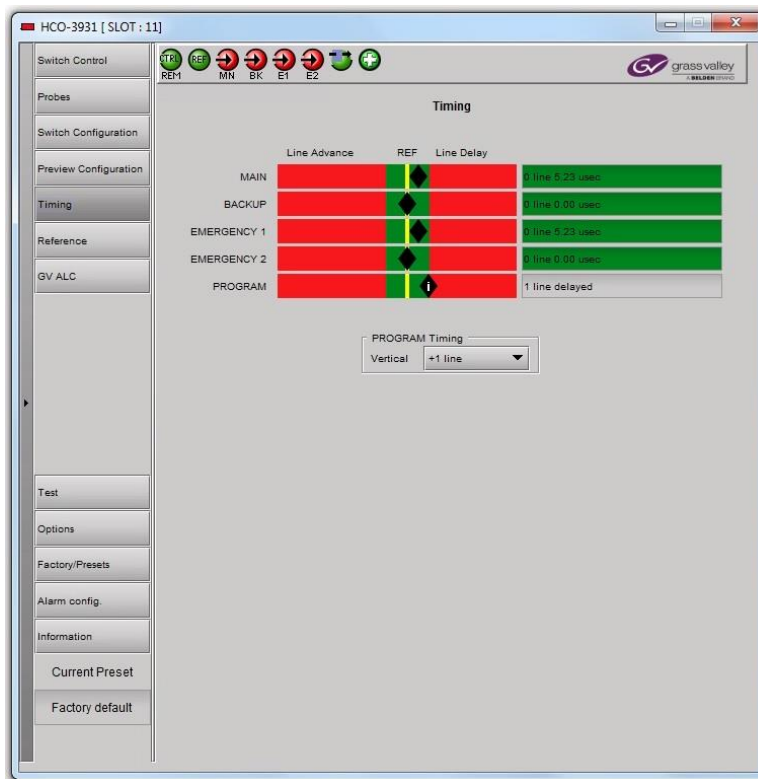

Figure 25 – Timing panel

Property	Description
PROGRAM Timing	Use the <i>Vertical</i> pulldown to offset the output from the reference by a number of video lines.

3.4.7 The Reference panel

The HCO-3931 output signals should always be genlocked to some reference source. The genlock source is selected in the Reference panel. The genlock is used to assure a switch during the vertical interval of the genlock source.

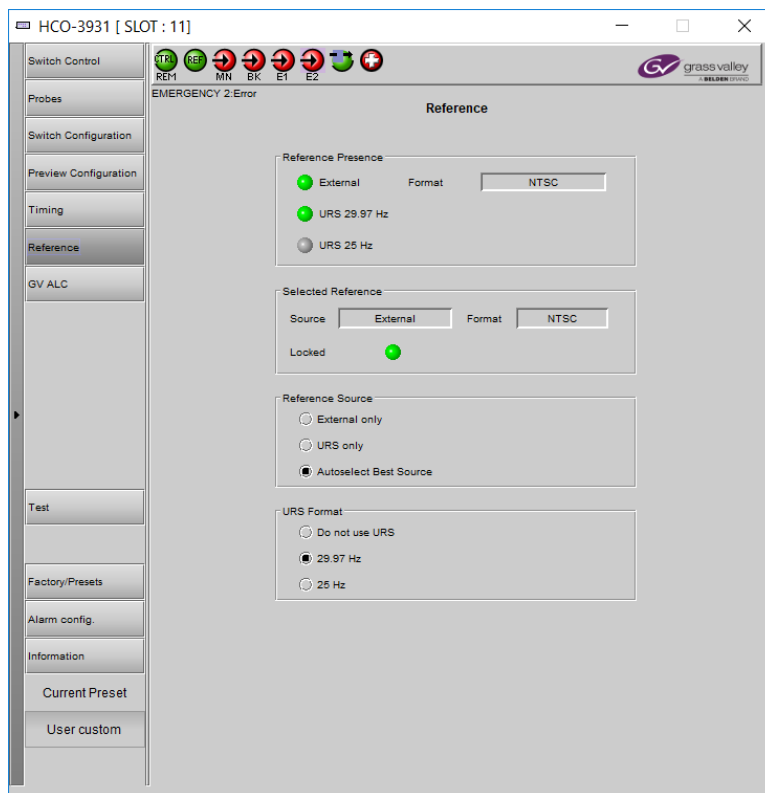

Figure 26 – Reference panel

Property	Description
Reference Presence	Shows the references currently available to the card. Green: The reference source is currently available to be used by the card. Gray: The reference source is unavailable. Yellow: The reference source is valid but not supported. External: Shows the availability of the reference found at the REF IN connector on the card’s rear panel. URS 29.97 Hz / 25 Hz: Shows the availability and the refresh rate of the reference found on the Densité frame’s backplane. Format: Shows the current external reference’s video format.
Selected Reference	Shows the current reference used by the card. Source: Shows the card’s current reference source. Format: Shows the card’s current reference format. Locked: Shows the card’s current reference locked state. Green: The preferred reference source is being used by the card. Gray: The preferred reference source is unavailable.
Reference Source	Set the card’s source for the reference. Note that the card always falls back to using the currently selected SDI input if the preferred source is not usable. External only: Uses the reference signal connected to the rear-panel REF IN connector URS only: Uses the reference signal found on the Densité frame’s backplane. Autoselect Best Source: This mode selects the reference source according to signal availability and refresh rate compatibility.

Property	Description
URS Format	<p>Selects the internal reference from the frame's backplane.</p> <p>Do not use URS: Disable the card's use of the reference signal found on the Densité frame's backplane.</p> <p>29.97 Hz: Use the the reference signal found on the Densité frame's backplane when its refresh rate is 29.97 Hz.</p> <p>25 Hz: Use the the reference signal found on the Densité frame's backplane when its refresh rate is 25 Hz.</p>

See the Timing panel (section 3.4.4) for a display of the measured timing between the outputs and the reference, and to set the output timing.

Note that the card de-activates clean switch (even if enabled in the current configuration) whenever using an SDI input as a reference source.

3.4.8 The ALC panel

Minimizing loudness differences between segments in a playout channel is an important issue in a world where multiple programs originating in different formats from different sources must be integrated seamlessly. The Automatic Loudness Control (ALC) option is the solution to this need. It uses Grass Valley's proprietary *wideband* ALC algorithm.

Enabled when the HCO-3931-OPT-ALC option is provisioned, this feature supports up to four programs, depending on the channel configuration selected for each one (mono channel, 2.0 channels, 3.0 channels, 4.0 channels, 5.1 channels and 7.1 channels).

Note: The ALC works with PCM audio. If non-PCM audio like Dolby-E or AC-3 is fed to the card, it will be ignored and all the program channels will be bypassed to prevent interference with the other PCM audio channel

3.4.8.1 Config tab

An input shuffler allows any combination of the available channels to be used as inputs to each ALC program.

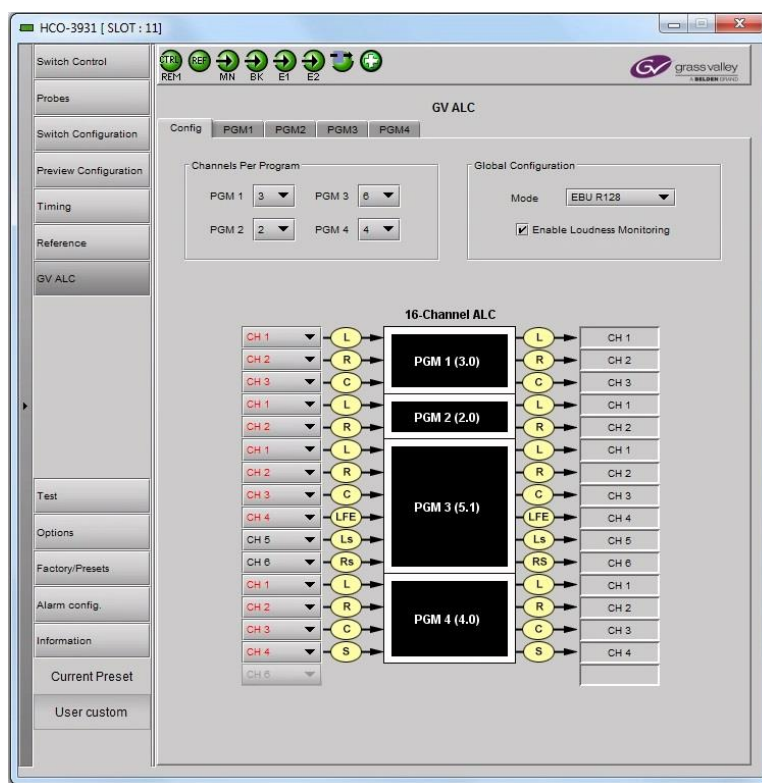

Figure 27 – GV ALC panel, Config tab

Property	Description
Channels Per Program	Select the number of channels per program.
Global Configuration	This sets the measurement units, the nominal value, as well as the window size for the ALC measurements configured in the PGM1-4 tabs. Select the ALC standard to apply to the audio content of all programs: <ul style="list-style-type: none"> • EBU R128 • A85 ITU-R BS.1770 • ARIB TR-B32

Property	Description
Enable Loudness Monitoring	Set to turn on the ALC input and output loudness monitoring for all programs.
Input channels selection	An input shuffler allows any combination of the available channels to be used as inputs to each ALC program. Note: An input channel cannot be assigned to more than one program.

3.4.8.2 PGM1-4 tabs

According to the **Global Configuration** setting in the **Config** tab, these tabs set the ALC levels for the four programs.

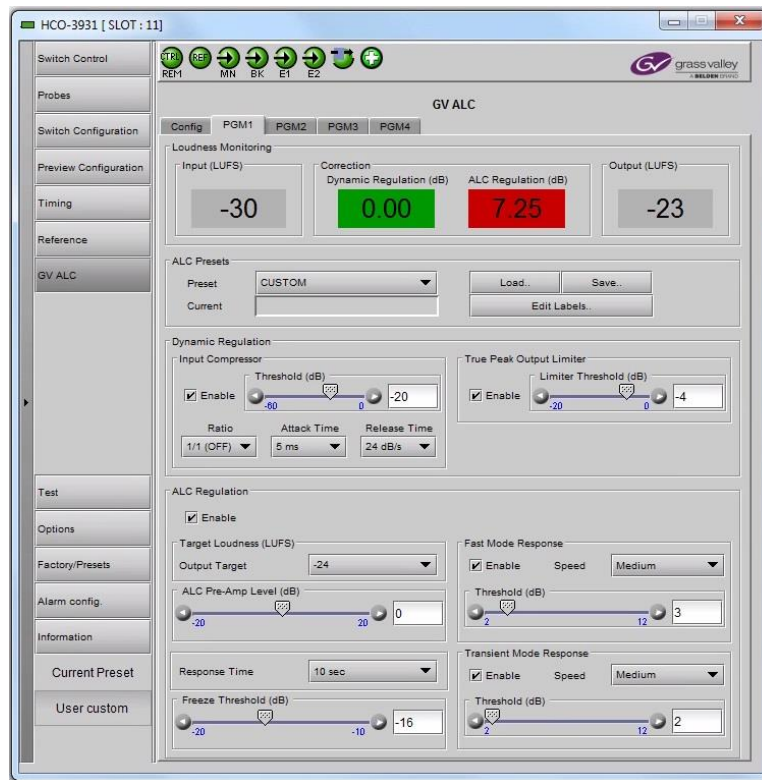

Figure 28 – GV ALC panel, PGM tab

Property	Description
Loudness monitoring	When Enable Loudness Monitoring is set, the loudness meters display the program input loudness before ALC processing (Input (LKFS/LUFS)), the dynamic correction applied by the ALC (Dynamic Regulation), the ALC limiter correction (ALC Regulation), and the program output loudness after ALC processing (Output (LKFS/LUFS)). The input and output loudness are given in LKFS or LUFS , depending on the selected ALC filter (LUFS for EBU R128 filtering, LKFS for the others). Loudness meters are integrated over a 10 second period using a “sliding-window”, which is equivalent to the <i>Short-term</i> mode in Dolby’s LM100 loudness meter. Dynamic and ALC regulation corrections are always given in dB. Each correction meter is integrated over a period of 250 milliseconds.

Property	Description
ALC Presets	<p>Three factory presets for the ALC are available to cover most broadcast applications.</p> <p>Factory Light: The ALC applies low dynamic range compression on the audio program content. The overall response time is relatively slow, which reduces the ALC ability to tightly follow the target output loudness. Using this preset, the program content will sound a little more dense, while keeping most of the original program dynamic range.</p> <p>Factory Standard: The ALC applies moderate dynamic range compression on the audio program content. The overall response time is also moderate, which allows the ALC to follow the target output loudness quite well. This preset is well-suited for most types of audio content. It is the factory preset loaded when loading the card default parameters.</p> <p>Factory Heavy: The ALC applies high dynamic range compression on the audio program content. The overall response time is relatively fast, which improves the ALC ability to tightly follow the target output loudness. Using this preset, the program output content will sound much more dense, less dynamic.</p> <p>Five user presets are also available to save and load custom configurations of the ALC. These presets are labeled ALC 1 to 5 but the user can edit the preset names through the “Edit Labels” button.</p> <p>We <i>STRONGLY</i> recommend starting with the ALC factory preset (Light, Standard, Heavy) that is closest to the desired objective, then fine tuning it to reach the desired goal. This will minimize the troubles that will likely be encountered as many adjustments interact.</p>
Dynamic Regulation, Input Compressor	<p>The Input Compressor reduces the dynamic range of a signal and is independent from the ALC and can be activated separately. All signal levels above the specified threshold are reduced by the specified ratio. When the signal level exceeds the threshold, the compressor will begin smoothly to reduce the gain, following the attack time, until the output level reflects the specified compression ratio. When the signal level is below the threshold, the compressor will begin smoothly to increase the gain, following the release time, until the output level matches the input level.</p> <p>For example, if the compressor threshold is set to -20 dBFS and a ratio of 1/2, and the input signal level is -10 dBFS (10 dB above the threshold), the signal level at the output of the compressor will be smoothly reduced to -15 dBFS (following the attack time). Then, if the input signal level suddenly drops to -30 dBFS (10 dB below the threshold), the signal level at the output of the compressor will smoothly go back to -30 dBFS (following the release time).</p> <div data-bbox="386 1199 859 1497" style="border: 1px solid black; padding: 5px; margin: 10px 0;"> <p style="text-align: center;">Compression Ratio & Threshold</p> <div style="display: flex; justify-content: space-around; margin-top: 5px;"> <div style="text-align: center;"> <p>1/1.5 & -20 dBFS</p> </div> <div style="text-align: center;"> <p>1/8 & -60 dBFS</p> </div> </div> </div> <p>Enable: Set to enable this stage of input Compressor processing for this program tab. Deselect to bypass this stage of ALC processing.</p> <p>Threshold: Set the compression threshold (that is, the break point in the transfer curve). The compression threshold specifies the level above which the compressor will process the signal.</p> <p>Ratio: Set the input compressor’s compression ratio (that is, the slope of the transfer curve). The compression ratio specifies how much the output level changes with respect to the input level.</p> <p>Attack Time: Set the input compressor’s attack time. This specifies how fast the compressor will reduce the gain.</p> <p>Release Time: Set the input compressor’s release time. This specifies how fast the compressor will increase the gain after a compression.</p>

Property	Description
Dynamic Regulation, True Peak Output Limiter	<p>The True Peak Output Limiter limits the output to remain under the selected threshold and is independent from the ALC and can be activated separately. This prevents loud portions of programs from being unintentionally clipped. As a 1ms protection buffer is included, and the output will never go over the limiter threshold setting.</p> <div data-bbox="337 407 813 699" style="border: 1px solid black; padding: 5px; margin: 10px 0;"> <p style="text-align: center;">Limiter Threshold</p> </div> <p>Enable: Set to enable this stage of output Compressor processing for this program tab. Deselect to bypass this stage of ALC processing.</p> <p>Limiter Threshold: If any input channel of a program is over this threshold, the limiter will reduce the entire program very quickly, within 1 millisecond. This limits the output loudness to always be under this threshold. This is used to avoid loud portions of programs to be unintentionally clipped.</p>
ALC Regulation	<p>According to the Global Configuration setting in the Config tab, these parameters set the loudness normalization and maximum level of audio signals.</p> <p>Enable: Set to enable this stage of ALC processing for this program tab. Deselect to bypass this stage of ALC processing.</p> <p>Target Loudness: Sets the target output loudness. This value sets the average output loudness, which means that due to the program dynamics, the output loudness will move around the selected target loudness. The units of measurement and the nominal value, as well as the window size for the measurements are set by the Global Configuration setting in the Config tab. Although the nominal Target Loudness is reset according to the Global Configuration setting is changed, you can change the value at any time using this pulldown, where the available range is -10 to -31 for all operating modes. See Figure 29 for the time-domain response of the ALC.</p> <p>ALC Pre-Amp Level: A pre-amp stage is available in front of the ALC to compensate for programs having an input loudness out of the ALC tracking range (very low or very high input loudness). The pre-amp level ranges from -20 dB to +20 dB, in steps of 1 dB.</p> <p>Response Time: Outside of the <i>Fast</i> and <i>Transient</i> modes ranges, the ALC performs loudness correction slowly, following the Response Time.</p> <p>Freeze Threshold: Sets the threshold below which the ALC will not increase loudness. This prevents quiet portions of programs (and noise) from being unintentionally boosted. If the input program loudness is under the Gate Threshold for more than 30 seconds, the ALC will smoothly return to 0 dB of loudness correction.</p> <p>Fast Mode Response: This is optional and is enabled by checking the Enable box. The ALC <i>Fast Mode Response</i> kicks in whenever the input loudness goes over the Fast Mode Threshold and loudness is reduced, at the rate set in the Speed pull-down (slow = 100ms; fast = 25ms). The Fast Mode Threshold is given in dB with respect to the target loudness and ranges from 2 to 12 dB, in dB steps.</p> <p>Transient Mode Response: This is optional and is enabled by checking the Enable box. The ALC <i>Transient Mode Response</i> kicks in whenever the input loudness goes over or under the Transient Mode Threshold. The Transient Mode Threshold is symmetric with respect to the target loudness and ranges from 2 to 12 dB, in dB steps. When the input loudness is over the Transient Mode Threshold, loudness is reduced following the rate set by the Speed pull-down. When the input loudness is under the Transient Mode Threshold, loudness is increased, again following the Speed pull-down, which ranges from Slow (up to 15 seconds) to Fast (up to 4 seconds).</p>

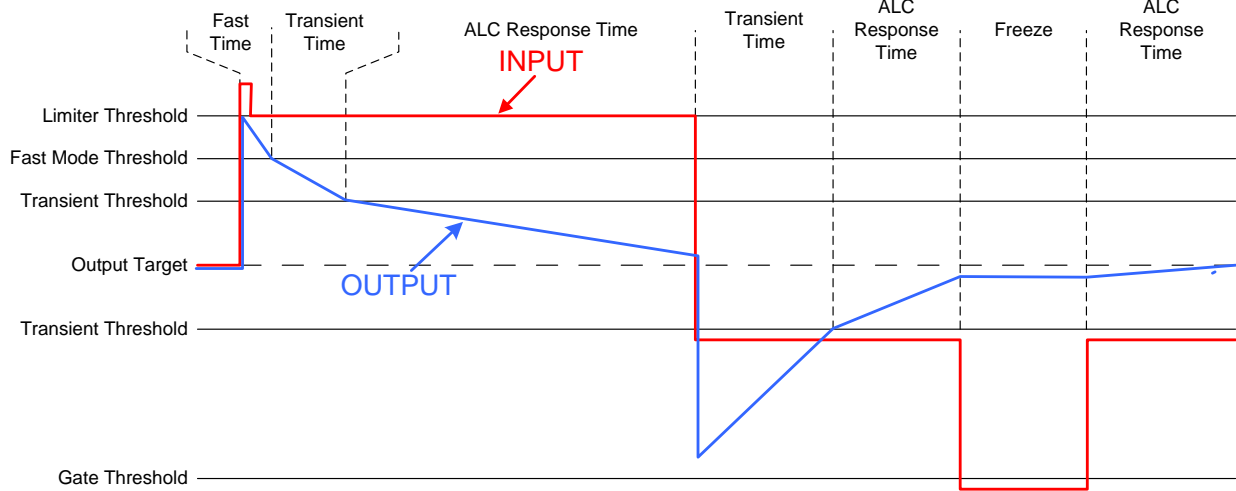

Figure 29 – GV ALC panel, PGM tab

3.5 Test Panel

You may activate the Color Bars & Tone test signal for the two channels independently by enabling the appropriate checkbox.

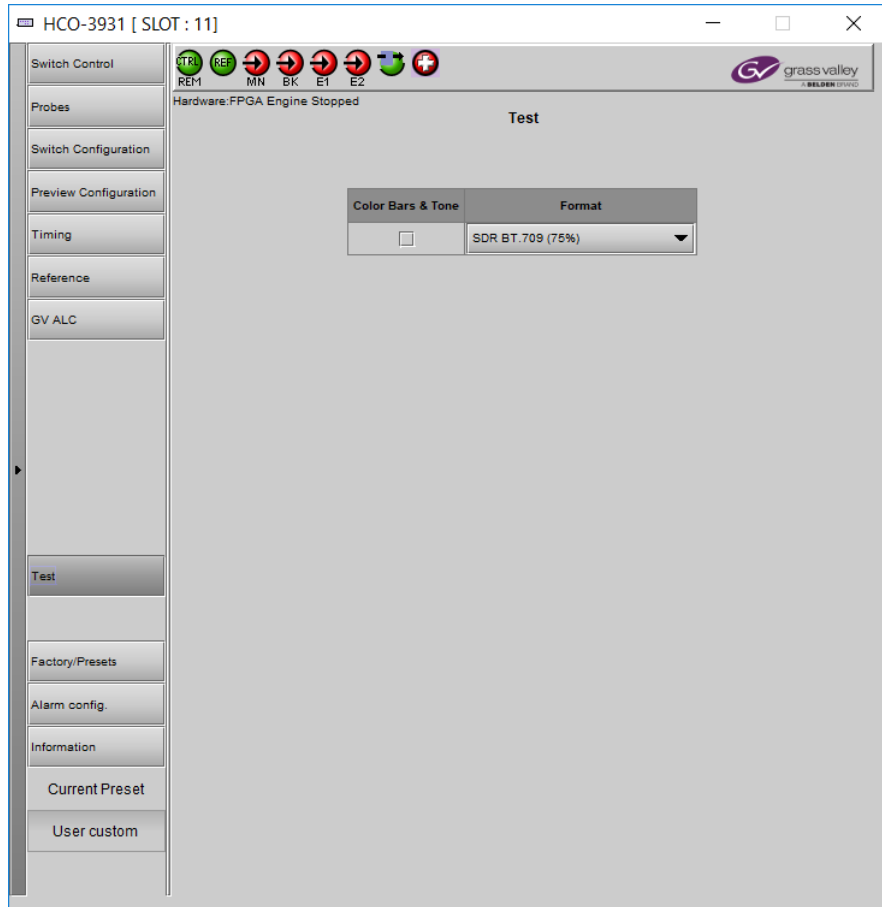



Figure 30– Test Panel

Property	Description
Color Bars & Tone	<p>Enables test signals at the card’s output:</p> <ul style="list-style-type: none"> • Video: Generate a video test pattern. On HD Video outputs, this will generate a 75% color bar with 75% white. On 3G and 12G Video outputs, test pattern will follow the format setting. • Audio: Generate a 1 KHz sine wave at -18dBFS on all audio channel outputs: <ul style="list-style-type: none"> • Continuous tone on right channel; pulsed tone on left channel of every pair (250 ms pulse every 3 seconds). • Audio inserted on Quad Link 3G - link 1 only. • Metadata: blank except for VPID on SDI output
Format	<p>Set video test pattern format for 3G, Quad Link 3G and 12G Video outputs:</p> <ul style="list-style-type: none"> • SDR BT.709 (75%): 75% Color bar with 75% white • HLG BT.2110-0: Test pattern HLG narrow range as per ITU-R BT.2111-0 • PQ Narrow BT.2111-0: Test pattern PQ narrow range as per ITU-R BT.2111-0 • PQ Full BT 2111-0: Test pattern PQ full range as per ITU-R BT.2110-0

Status

When Test mode is activated on a channel, the status icon display for that channel will show the Color Bars&Tone icon.

Test Pattern	Operating Mode	Icon
Enabled	Color Bars&Tone	
Disabled	Process	

3.5.1 The Factory panel

3.6 Factory/Presets Panel

This panel provides access to three functions:

- User Presets. See 3.6.1 - User Presets on page 53.
- Factory. See 3.6.2 - Load Factory button on page 54.
- Profiles. See 3.6.3 - Profiles on page 54.

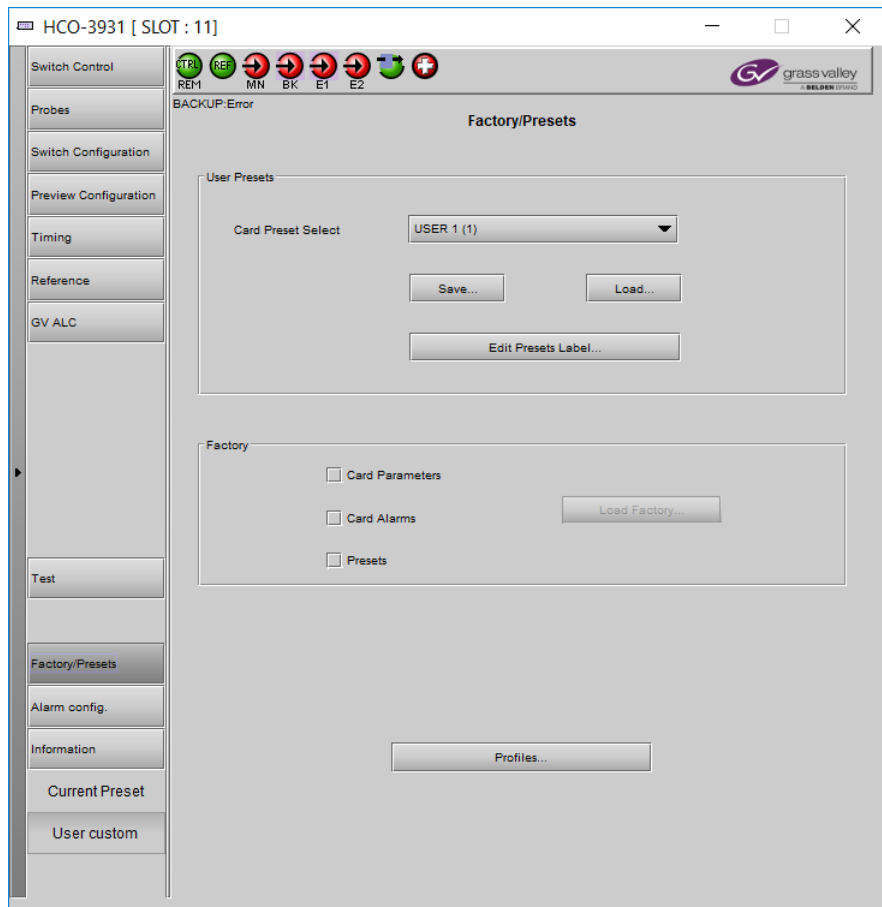

Figure 31– Factory/Presets Panel

At the bottom left of the window, the Current Preset field displays the presets that are currently used on the HCO-3931 application. Possible values are:

- Factory default
- User defined presets (for example, USER 1)
- User custom (when a setting has been modified from a defined preset or factory default settings)

3.6.1 User Presets

The HCO-3931 has memory registers that can hold up to five user-defined parameter settings.

Select any one of the five presets using the Card Preset Select pulldown menu.

Click **Load** to load the contents of the selected user preset into the HCO-3931 application. All parameter settings and values will be replaced by the contents of the selected user preset.

A confirmation box will pop up to allow you to proceed or cancel the load.

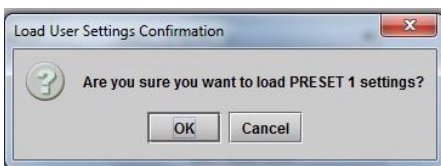

Figure 32–Load User Settings Confirmation Box

Click **Save** to store the current parameter settings and values from the HCO-3931 in the selected user preset. The existing contents of the preset will be overwritten. A confirmation box will pop up to allow you to proceed or cancel the save.

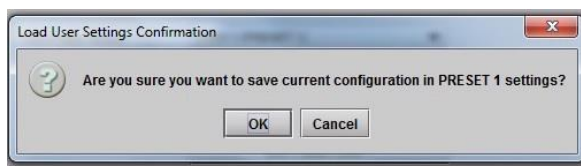

Figure 33–Save Configuration Confirmation Box

You can edit the name assigned to each user preset.

- Click **Edit Presets Label** to open the Presets window.
- Double-click on a name in the Label column.
- Type a new name in the window.
- Click **OK**.

The text you have entered (up to 16 characters) will be appended to the label name in the pulldown menu.

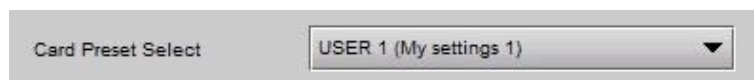

Figure 34– Card Preset Select

3.6.2 Load Factory button

Clicking the Load Factory button will restore the card to a factory default state. Three checkboxes can be used to choose whether to include card parameters, card alarms and presets in the restoration process.

Note: Card alarms are reset to factory values; iControl alarms and GSM alarms are not reset.

3.6.3 Profiles

Use Profiles to save or recover the entire card configuration (including user presets if desired) on an external disk, or to copy it to another HCO-3931 card located in any Densité frame in the system.

Click **Profiles** to open the Profile Copy window.

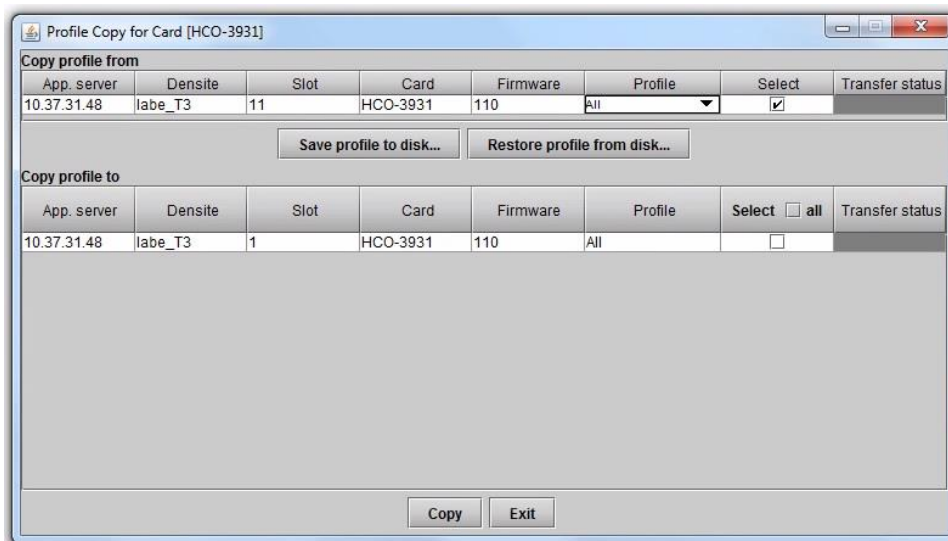

Figure 35–Profile Copy for Card

Copy profile from

This line shows the HCO-3931 card and its App. server, Densité frame, slot number, card type, firmware version and profile.

The Profile column has a pulldown menu that allows you to select from the following options:

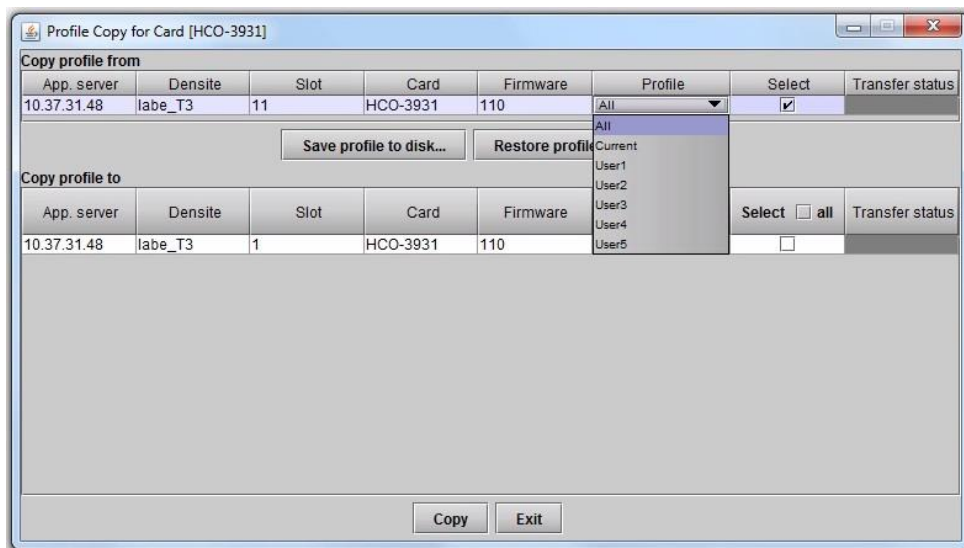

Figure 36–Profile Column Pulldown Menu

Property	Description	Profile Option Saves	
		Card Parameters	Configuration, Alarms
All	The card’s current configuration and all presets will be copied or saved to disk.	☑	☑
Current	Only the card’s current configuration will be copied or saved on disk.	☑	☑
User Presets 1 - 5	Only the selected preset will be copied or saved on disk.	☑	☑

The Select column includes a checkbox (pre-checked) to confirm that you want to work with the current card.

Save profile to disk...

After selecting which profiles to save, click this button to open a Save dialog. Specify a file name and location to which the selected profiles for this card will be saved.

Note: It is a good idea to create a folder for these files, because they are not explicitly identified as HCO-3931 profiles and will be difficult to identify if not clearly named and conveniently located.

- Click **Save** once the name and location have been identified in the Save box. The Transfer Status box on the right of the Copy profile from line will indicate In Progress against a yellow background.



- If the file was saved correctly, the Transfer Status box will indicate Succeeded against a green background.

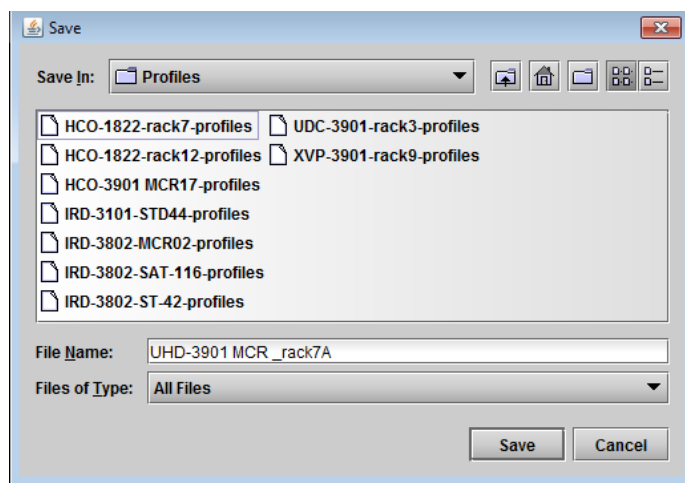
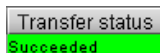
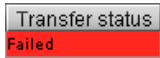

Figure 37–Save Profile to Disk Dialog

- If the file was not saved for some reason, the Transfer Status box will indicate Failed against a red background.



Restore profile from disk...

Click this button to open an Open dialog box to locate and select a valid HCO-3931 profile file.

- Click **Open** to read the contents of the file and reconfigure the HCO-3931's profiles accordingly.
- While the reconfiguration is in progress, the Transfer Status box on the right of the Copy profile from line will indicate Working against a yellow background.
- When the reconfiguration is complete, the Transfer Status box will indicate Succeeded against a green background.

On a restore profile from disk, there is no need to select a profile type (ALL, Current, User1 to User5). All the profile contents of the file will be restored.

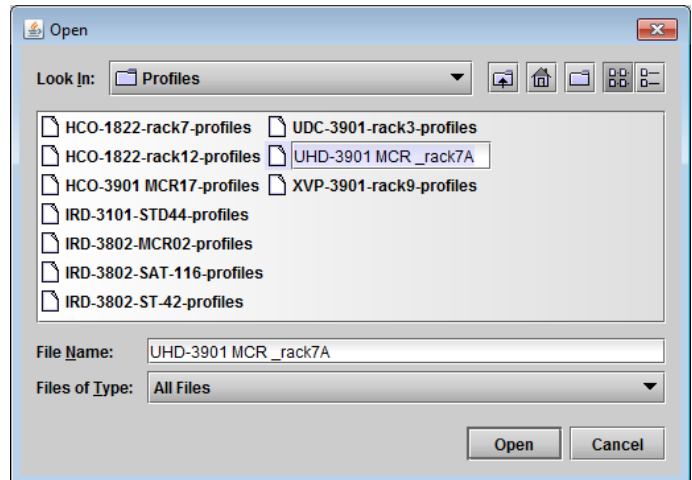

Figure 38—Restore Profiles from Disk Dialog

Copy profile to

This section shows other HCO-3931 cards that are available on the iControl network, each identified by its app. server, Densité frame, slot number, card type and firmware version.

The **Profile** column shows the same setting as selected for the current card in the **Copy profile from** line. See Figure 36.

The **Select** column includes a checkbox to identify the HCO-3931 cards to which profiles will be copied from the current card.

- For convenience, a Select all checkbox is provided in the column header.

Click **Copy** to copy the selected profiles from this card into the selected other HCO-3931 cards.

- While the profile copy operation is in progress, the Transfer Status box on the right of the Copy profile to line will indicate Working against a yellow background.
- When the profile copy operation is complete, the Transfer Status box on the right of the Copy profile to line will indicate Succeeded against a green background.

Note: The source and destination cards must have the same firmware version. Any destination cards with a different firmware version that are shown in the Copy profile to list cannot be selected, and their transfer status is always N/A on a yellow background.

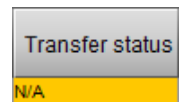

3.7 Alarm Config Panel

This panel is used to configure the alarm reporting of the HCO-3931 application. The panel opens in a new window when the button is clicked and can be resized.

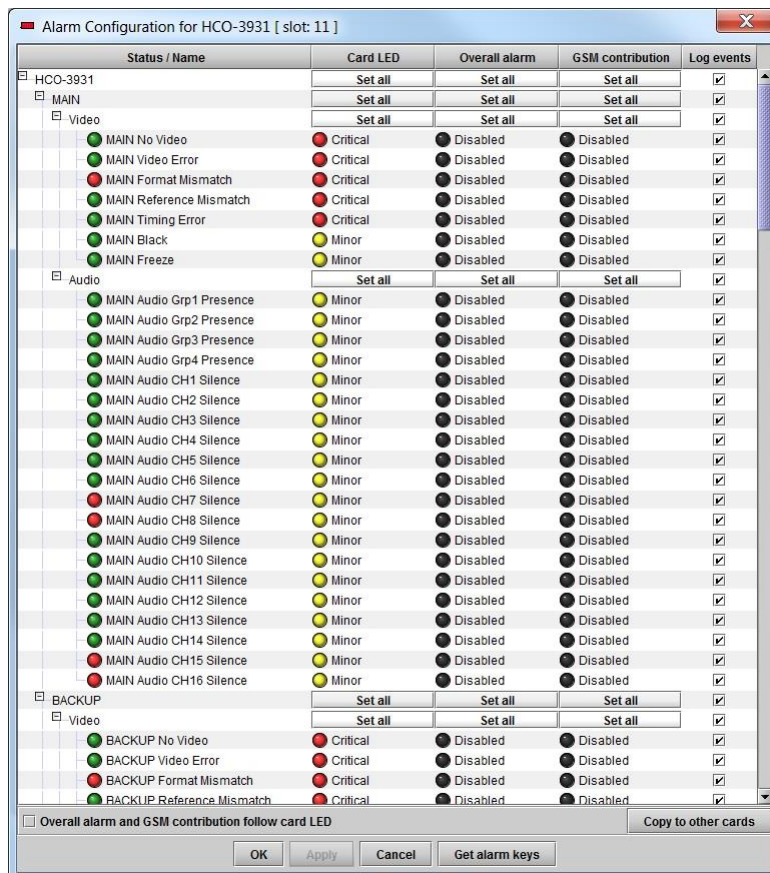

Figure 39–Alarm Configuration

Status/Name

This column contains an expandable tree listing all the alarms reported by this HCO-3931 card.

- Each alarm name includes an icon that shows its current status.
- Some alarms may be text-only, and the alarm status is shown in the name and not by a status icon.

Card LED, Overall Alarm and GSM Contribution

These columns contain pulldown menus used to set the severity level of each individual alarm to the alarm named in the column heading. This can be set independently for Card LED, Overall Alarm and GSM Contribution.



Card LED

This column is used to set the severity level of the selected individual alarm to the status LED located on the front card-edge. The Card LED status is shown at the bottom of the alarm tree in the Status/Name column. If at least one Critical or Major alarm is triggered, the LED will change to red. If no Critical or no Major alarms are triggered and Minor alarms are occurring, the LED will change to yellow.

Overall Alarm





This column is used to set the severity level of each individual alarm to the Overall Alarm associated with the card. The Overall Alarm is shown in the upper left corner of the iControl panel and also appears at the bottom of the Status/Name column.

Log Events

iControl maintains a log of alarm events associated with the card. The log is useful for troubleshooting and identifying event sequences. Check the box to log alarm events for each individual alarm.

Levels associated with these alarms:

The pulldown menus may contain some or all of the following settings:

	Disabled	The alarm makes no contribution (black icon)
	Minor	The alarm is of minor importance (yellow icon)
	Major	The alarm is of major importance (orange icon)
	Critical	The alarm is of critical importance (red icon)
	Passthrough	The alarm exists but has no effect (used for text and composite alarms)

Note: As a shortcut, you can click one of the Set All boxes beside a section heading to open a pulldown menu that lets you assign a level to all alarms in that section of the column simultaneously.

Once the alarms are configured, you may accept the changes or discard them:

Overall alarm and GSM contribution follow card LED

Check the box to force the Overall Alarm and GSM contribution to match the Card LED status.

- All Overall Alarms and GSM contributions for which there is a Card LED alarm will be forced to match the Card LED alarm.
- All Overall Alarms and GSM contributions for which there is no Card LED alarm will be forced to be Disabled.

A warning dialog box will open to ask you to confirm the action, since it will change the configuration and cannot be undone.

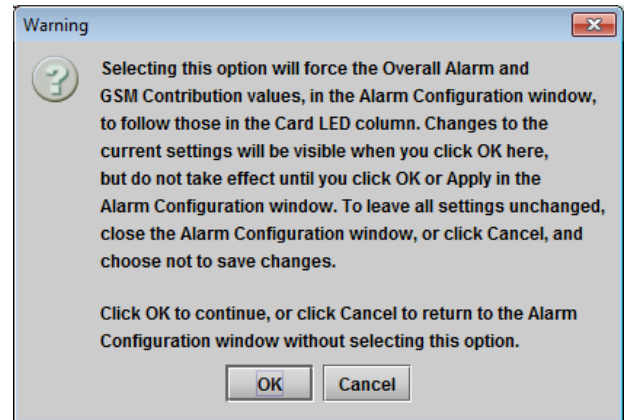

Figure 40–Warning for Follow LED Change

Copy to other cards

Click this button to open a panel that is used to copy the alarm configuration set for this card to another HCO-3931 card.

- Select one or more destination cards from the list in the window by checking the boxes, or check **All** to select them all.
- Note that when you copy a profile for the HCO-3931 card (see 3.6.3 - Profiles), the alarm configuration is copied along with all the other settings.

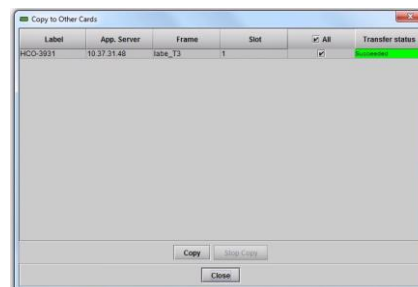

Figure 41—Copy to Other Cards Window

Get alarm keys

Click this button to open a save dialog where you can save a file containing a list of all alarms on this card and their current values, along with an alarm key for each. The alarm keys are useful for system integration and troubleshooting.

- The file is saved in .csv format.

OK, Apply, Cancel

- **OK:** Accepts the settings and closes the window once the card confirms that there are no errors.
- **Apply:** Accepts the settings but leaves the window open.
- **Cancel:** Closes the window without applying any changes and leaves the previous settings intact.

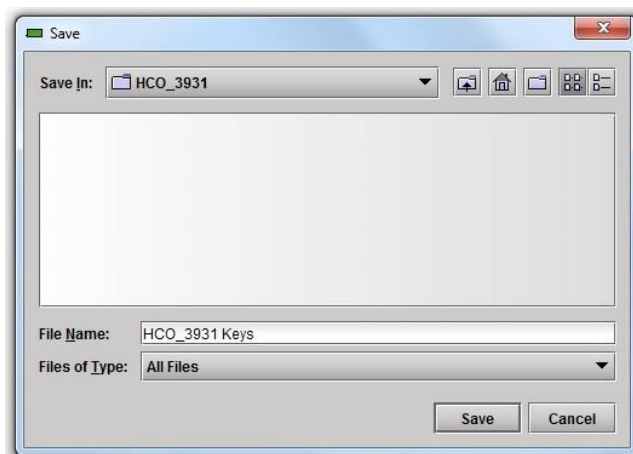

Figure 42—Get Alarm Keys Dialog

3.8 Information Panel

When the HCO-3931 is included in an iControl environment, certain information about the card should be available to the iControl system. You can enter labels and comments that will make this card easy to identify in a complex setup. This information is entered into data boxes in the Info control panel.

- **Label:** Enter the label that appears for the HCO-3931 application in iControl applications.
- **Short label:** Enter the short-form label sometimes used by iControl (8 characters).
- **Source ID:** Enter a descriptive name for the HCO-3931 application.
- **Comments:** Enter any desired text.

The remaining data boxes show manufacturing information about the card.

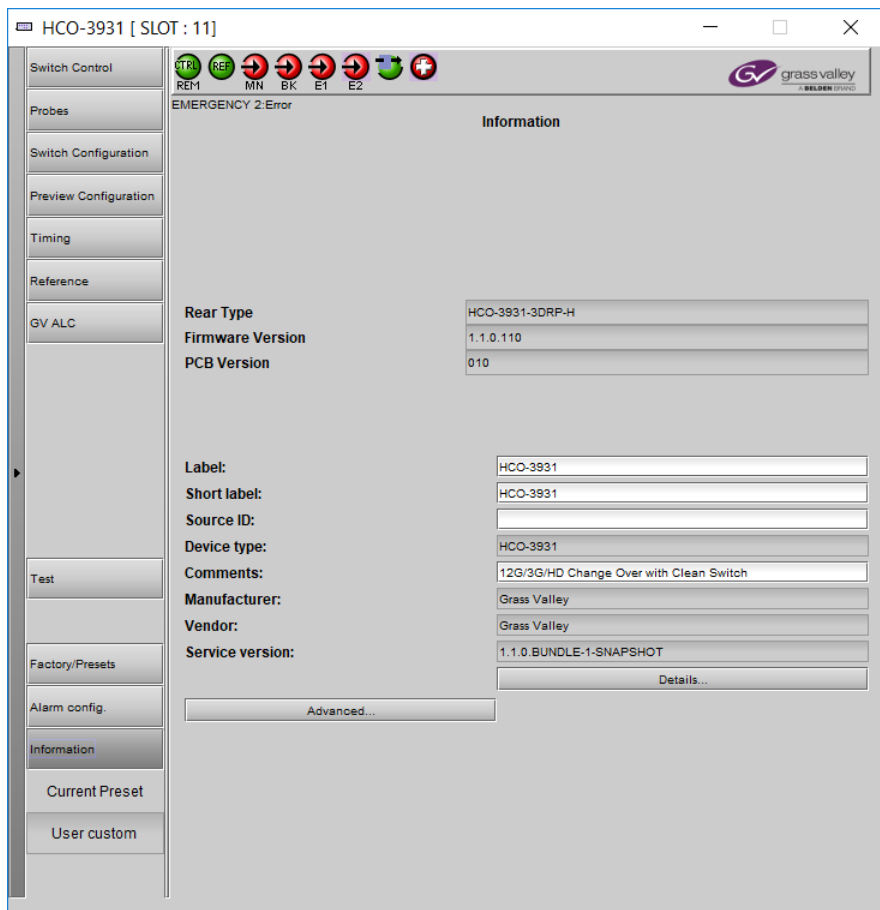

Figure 43– Info Panel

Three buttons in the panel give access to other information.

- **Details...:** Reports the service version and panel version for the card.

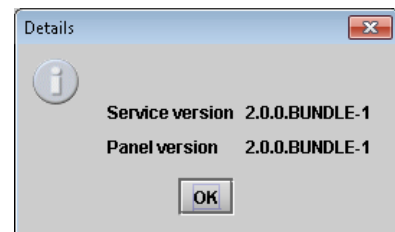

Figure 44–Details Window

- **Advanced...:** Shows the Long ID for this card. The Long ID is the address of this HCO-3931 application on the iControl network.

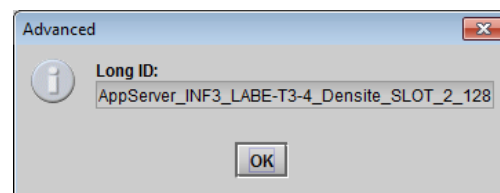

Figure 45—Advanced Window

4 Specifications

SDI (Inputs/Outputs)

Physical	8 HD-BNC connectors 4 in, 4 out
SDI Standard	SMPTE ST 292 (1.485, 1.485/1.001 Gb/s) SMPTE ST 424 (2.970, 2.970/1.001 Gb/s) SMPTE ST 2082-1:2015 (2.970, 2.970/1.001 Gb/s)
Supported Formats	HD: SMPTE ST 274: 1080i59.94, 1080i50 HD: SMPTE ST 296: 720p59.94, 720p50 3G: SMPTE ST 425 Level A (mapping 1) Level B dual link: 1080p59.94, 1080p50 12G: SMPTE ST 2082-10: 2160p59.94, 2160p50

Cable length (Belden 1694A)	HD: 180m (590 ft.) at 1.485 Gb/s 3G: 100m (328 ft) at 2.970 Gb/s
-----------------------------	---

Cable length (Belden 4794R)	12G: 30m (98 ft.) at 11.88 Gb/s
-----------------------------	---------------------------------

NOTE: Cable length specifications are for worst case scenario when outputs are protected by the active bypass or relay.

Reference Input

Physical	1 HD-BNC connector
Standard	SMPTE ST 170/SMPTE ST 318/ITU 624-4 blackburst
Return loss	>35 dB up to 5.75 MHz

GPIO (10)

Connector	HD-15, opto-isolated, common ground
GPIO IN (5)	Contact closure to ground
GPIO OUT (5)	Contact closure to ground
External pull up voltage	3.3V to 24V max.
External GPIO power	5V nominal

Video Processing Performance

Signal path	10 bits
Latency	0.5 lines without Clean Switch and ALC enabled Maximum of 2.5 lines with Clean Switch or ALC enabled

Audio Processing Performance

Quantization	20-24 bits Sampling: 48 kHz, synchronous
Number of channels	16, 4 groups
Audio latency	1.8 ms without Clean Switch and ALC enabled Add 42 μ s if Clean Switch is enabled Add 21 μ s if ALC is enabled

Electrical

Power	15W maximum
-------	-------------

5 Contact Us

Grass Valley Technical Support

For technical assistance, contact our international support center, at 1-800-547-8949 (US and Canada) or +1 530 478 4148.

To obtain a local phone number for the support center nearest you, please consult the *Contact Us* section of Grass Valley's website (www.grassvalley.com).

An online form for e-mail contact is also available from the website.

Corporate Head Office

Grass Valley
3499 Douglas-B.-Floreani
St-Laurent, Quebec H4S 2C6
Canada

Telephone: +1 514 333 1772

Fax: +1 514 333 9828

www.grassvalley.com

ANNEX 1 – HCO-3931 User Interface

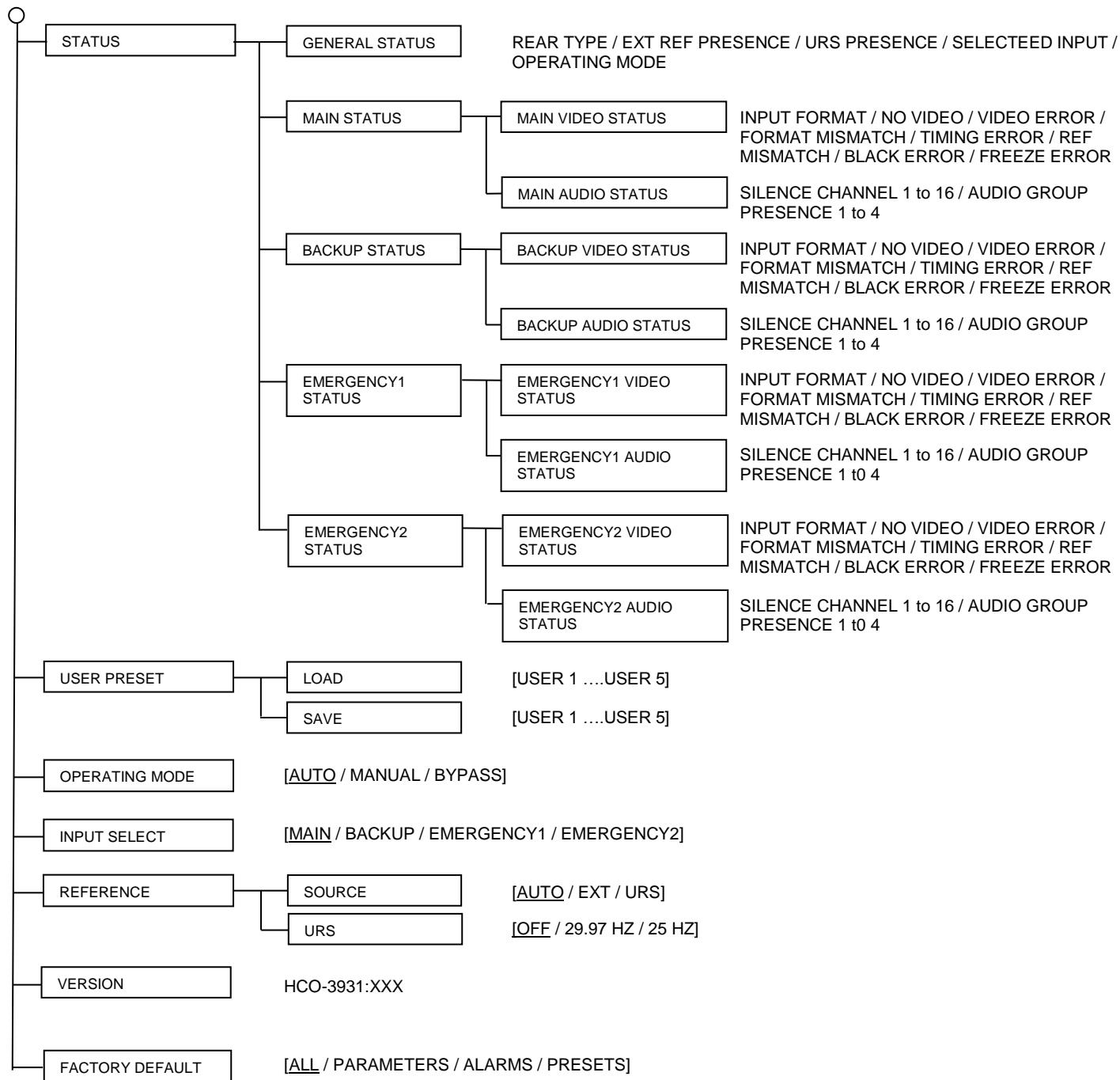

Sets all parameters shown above to their underlined default values.