



grass valley

A **BELDEN** BRAND

IPG-3901

High Density SDI/IP Gateway

Guide to Installation and Operation

M3036-9900-223

2017-11-13

www.grassvalley.com

Document History

Document Number	Date of Publication	Notes
3036-99M00-100	2015-10-06	Initial Release.
3036-99M00-110	2016-02-23	Support for external reference added.
3036-99M00-120	2016-04-27	Support for Aggregation mode added.
3036-99M00-132	2016-08-18	Support for 4K/TICO added.
3036-99M00-134	2016-10-11	Minor documentation updates.
3036-99M00-220	2017-08-28	Support for AES-67 and PTP added. Support for TICO temporarily suspended.
3036-99M00-223	2017-11-13	Add asynchronous input specification.

Copyright and Trademark Notice

Copyright © 2015-2017, Grass Valley Canada. All rights reserved.

Belden, Belden Sending All The Right Signals, and the Belden logo are trademarks or registered trademarks of Belden Inc. or its affiliated companies in the United States and other jurisdictions. Grass Valley, Miranda, IPG-3901, iControl, and Densité are trademarks or registered trademarks of Grass Valley Canada. Belden Inc., Grass Valley Canada, and other parties may also have trademark rights in other terms used herein.

Terms and Conditions

Please read the following terms and conditions carefully. By using IPG-3901 documentation, you agree to the following terms and conditions.

Grass Valley hereby grants permission and license to owners of IPG-3901 to use their product manuals for their own internal business use. Manuals for Grass Valley products may not be reproduced or transmitted in any form or by any means, electronic or mechanical, including photocopying and recording, for any purpose unless specifically authorized in writing by Grass Valley.

A Grass Valley manual may have been revised to reflect changes made to the product during its manufacturing life. Thus, different versions of a manual may exist for any given product. Care should be taken to ensure that one obtains the proper manual version for a specific product serial number.

Information in this document is subject to change without notice and does not represent a commitment on the part of Grass Valley.

Warranty information is available in the Support section of the Grass Valley Web site (www.grassvalley.com).

Electrostatic Discharge (ESD) Protection



Electrostatic discharge occurs when electronic components are improperly handled and can result in intermittent failure or complete damage adversely affecting an electrical circuit. When you remove and replace any card from a frame always follow ESD-prevention procedures:

- Ensure that the frame is electrically connected to earth ground through the power cord or any other means if available.
- Wear an ESD wrist strap ensuring that it makes good skin contact. Connect the grounding clip to an *unpainted surface* of the chassis frame to safely ground unwanted ESD voltages. If no wrist strap is available, ground yourself by touching the *unpainted* metal part of the chassis.

- For safety, periodically check the resistance value of the antistatic strap, which should be between 1 and 10 megohms.
- When temporarily storing a card make sure it is placed in an ESD bag.
- Cards in an earth grounded metal frame or casing do not require any special ESD protection.

Recycling

Visit www.grassvalley.com for recycling information.

Certification and Compliance

Safety of Laser Modules



This equipment incorporates modules containing Class 1 lasers. These modules are certified by the manufacturer to comply with:

- IEC/EN 60825-1 Safety of laser products
- IEC 60950-1 Safety of information technology equipment

Restriction on Hazardous Substances (RoHS)

IPG-3901	有毒有害物质或元素 (Toxic or Hazardous Substances and Elements)					
	铅 (Pb)	汞(Hg)	镉(Cd)	六价铬 (Cr6)	多溴联苯 (PBB)	多溴二苯 (PBDE)
部件名称 Part name						
电缆及电缆组件 Cables and Cable Assemblies	O	O	O	O	O	O
电路模块 Circuit Modules	X	O	O	O	O	O
组装风扇 Fan Assemblies	X	O	O	O	O	O
IPG-3901-3DRP, IPG-3901-3TRP	有毒有害物质或元素 (Toxic or Hazardous Substances and Elements)					
	铅 (Pb)	汞(Hg)	镉(Cd)	六价铬 (Cr6)	多溴联苯 (PBB)	多溴二苯 (PBDE)
部件名称 Part name						
电路模块 Circuit Modules	X	O	O	O	O	O

O: 表示该有毒有害物质在该部件所有均质材料中的含量均在SJ/T 11363-2006规定的限量要求以下。

O: Indicates that this toxic or hazardous substance contained in all of the homogeneous materials for this part is below the limit requirement in SJ/T11363-2006.

X: 表示该有毒有害物质至少在该部件的某一均质材料中的含量超出SJ/T 11363-2006规定的限量要求。

X: Indicates that this toxic or hazardous substance contained in at least one of the homogeneous materials for this part is above the limit requirement in SJ/T11363-2006.

技术条款解释：

此声明所依据之数据由Grass Valley环境管理部门向我们的部件供应商获取。Grass Valley 公司相信此信息的正确性，但由于数据来源于公司外部，我们无法保证它的完整和准确。所有这些特性可能在未获通知的情况下更改。

Technical explanations:

This statement is based on the information provided by our suppliers of components and collected through Grass Valley's environmental management system. Grass Valley believes this environmental information to be correct but cannot guarantee its completeness or accuracy as it is based on data received from sources outside our company. All specifications are subject to

change without notice.

Electromagnetic Compatibility



This equipment has been tested for verification of compliance with FCC Part 15, Subpart B requirements for Class A digital devices.

NOTE: This equipment has been tested and found to comply with the limits for a Class A digital device, pursuant to part 15 of the FCC Rules. These limits are designed to provide reasonable protection against harmful interference when the equipment is operated in a commercial environment. This equipment generates, uses, and can radiate radio frequency energy and, if not installed and used in accordance with the instruction manual, may cause harmful interference to radio communications. Operation of this equipment in a residential area is likely to cause harmful interference in which case the user will be required to correct the interference at his own expense.



This equipment has been tested and found to comply with the requirements of the EMC directive 2004/108/CE:

- EN 55022 Class A radiated and conducted emissions
- EN 61000-3-2 Harmonic current emission limits
- EN 61000-3-3 Voltage fluctuations and flicker limitations
- EN 61000-4-2 Electrostatic discharge immunity
- EN 61000-4-3 Radiated electromagnetic field immunity – RF
- EN 61000-4-4 EFT immunity
- EN 61000-4-5 Surge immunity
- EN 61000-4-6 Conducted immunity
- EN 61000-4-8 EMP immunity
- EN 61000-4-11 Voltage-dips, short-interruption and voltage variation immunity

Table of Contents

1	IPG-3901 High Density SDI/IP Gateway for Densité 3 Platform.....	1
1.1	Introduction	1
1.2	Features	1
1.3	Functional Block Diagrams	2
1.4	Front Card-edge Interface.....	3
2	Installation.....	4
2.1	Installation of Rear Connector Panels	4
2.2	IPG-3901 Card Installation.....	4
2.3	Rear Panels and Connectors.....	5
2.3.1	Images of Rear Panel Connectors.....	5
2.3.2	Summary of rear panel connections	5
2.3.3	Details of rear panel connections	6
3	User Interface.....	7
3.1	Control options.....	7
3.2	Card-Edge Status LED	7
4	Local control using the Densité frame control panel	8
5	Remote control using iControl.....	9
5.1	The iControl graphic interface window.....	9
5.2	Gateway panel	12
5.2.1	Gateway Config window	12
5.2.2	Gateway – Output tab	19
5.2.3	How to set up the SDI Output timing on the IPG-3901	22
5.2.4	Gateway – Input tab.....	24
5.2.5	Gateway – System tab.....	26
5.3	Network panel	27
5.3.1	Network panel – Settings tab	27
5.3.2	Network panel – Status tab.....	27
5.3.3	Network Config panel – Statistics tab	28
5.4	TICO Panel	29
5.4.1	Advanced tab	29
5.4.2	Config tab.....	31
5.4.3	TICO Encoder monitoring	32
5.4.4	Metadata (including audio) when TICO is in use	32
5.5	Reference Panel	33
5.5.1	Reference Panel - Selection Tab.....	33
5.5.2	Reference Panel – PTP tab	34
5.5.3	PTP Failover	35
5.6	Test panel	36
5.7	Options Panel.....	37
5.8	Factory/Presets Panel.....	37
5.8.1	Factory	38
5.8.2	Profiles	38
5.9	Alarm Config Panel	41

5.10 Info Panel.....	44
5.10.1 Info Panel – Info tab	44
5.10.2 Info Panel – Technical Support tab	45
6 Specifications	46
7 Contact Us.....	47
Grass Valley Technical Support	47
Corporate Head Office.....	47
ANNEX 1 – Local Menu	48
ANNEX 2 – Firmware upgrade	51
ANNEX 3 – Block Diagrams of TICO Models	53

1 IPG-3901 High Density SDI/IP Gateway for Densité 3 Platform

1.1 Introduction

The Densité IP Gateway (IPG-3901) plug-and-play module from Grass Valley, a Belden Brand, is a 3 RU module for the Densité 3 frame that offers bidirectional IP/SDI conversion. The Gateway operates with 10 GigE IP video-over-IP, supporting 4K UHD/3G/HD/SD-SDI formats. Version 2.2.2 of the gateway module furthers the end-to-end support of IP for Grass Valley product lines by now offering support for Video Services Forum Technical Recommendation 04 (VSF TR-04), enabling independent routing of AES audio alongside SMPTE ST 2022-6 video and interconnection to audio devices supporting AES67 open standard for audio over IP.

With the addition of intoPIX TICO mezzanine encoding and decoding option on the gateway, customers have a convenient way to add 4K to their workflow and move 4K across the production facility. TICO mezzanine compression is visually lossless 4:1 compression, which is lightweight and fast, perfectly suitable for live production. The IPG-3901 with purchasable TICO option provides either two (2) encodes OR two (2) decodes OR one (1) encode and one (1) decode per card.

Note – TICO functionality, available in v1.3, is not supported in this v2.2 release. It will be reinstated in v2.3.

The gateways support any mix of 3G/HD/SD-SDI production workflows over IP networks. With bidirectional I/O in combinations of up to 5 in and out, the cards offer full SMPTE 2022-7 Class A redundancy of all video and audio essence in either unicast or multicast workflows to ensure uninterrupted service.

In addition, you also have the choice to use the second ethernet port for aggregation instead of redundancy, providing 20 GigE of bidirectional bandwidth over two 10 GigE ports, increasing the capability to transport 6 in/5 out or 5 in/6 out 3G signals per IPG card. It also lets you transport more HD/SD signals in one direction by taking advantage of the bidirectional configuration of 7 BNC I/O, providing up to 9 in/2 out or 2 in/9 out.

With SMPTE 2022-7 Class A redundancy and large frame buffers, the new IP receivers in the IPG-3901 v2.2 allow for reception of sources with high levels of jitter as well as network isolated packet loss. The SDI outputs are now aligned with respect to a given reference for precise timing adjustment ensuring signal stability.

Based on the proven Densité modular framework of over 100 functional cards, the flexible, space-efficient IPG-3901 cards accommodate a gradual adoption of IP production elements into broadcasting workflows, while protecting operational methods and investment in installed equipment.

With flexibility to configure up to 6 IPG-3901 modules per Densité 3 frame and with each IPG-3901 module carrying 10 HD or 6 3G gateways with full redundancy, the Densité 3 platform scales to a density of 60 HD or 36 3G gateways in a 3 RU frame. In the new Densité 3+ FR4 frame, up to 12 IPG-3901 modules can be installed giving a density of 120 HD or 72 3G gateways in a 4 RU frame. This means space- and cost-efficient scaling – today and tomorrow.

The Densité IP Gateway can be controlled by the advanced GV Convergent SDN platform, offering unified control across COTS IP switches and SDI routing/processing infrastructures, as well as by the proven iControl systems.

1.2 Features

- Two dual-network interfaces supporting 10 GigE SFP+ ports with either:
 - Long range single-mode optical connectors
 - Short range multi-mode optical connectors
 - Direct Attach Copper assemblies
 - Active Optical Cables and Optical Transceiver
- Bidirectional transport of 4K UHD/3G/HD/SD-SDI video signals over 10GigE port.

- TR-04 support where video signals are converted into SMPTE 2022-6 along with AES67 de-embedding/embedding of up to 16 audio channels per source.
- Redundancy mode with full compliance to SMPTE ST 2022-7 Class A of all IP essences where each module connects up to 3x3 3G or 5x5 HD/SD signals
- Aggregation mode where both network ports are combined for a total IP bandwidth of 20 GigE, providing higher 3G transmission capability per IPG card such as the transfer of 4K UHD uncompressed over a 4K link on a single IPG. In this mode, bidirectional I/O for 2 inputs, 2 outputs and 7 bidirectional I/Os for up to 11 streams.
- Large frame buffer on every IP receiver provides support for server-originated bursty sources
- All SDI outputs are aligned with respect to the module reference for precise timing adjustment ensuring signal stability.
- Supports multicast loopback with SDI output alignment.
- Flexible SD/URS reference input.
- IGMPv3 support for IP inputs.
- Supports unicast and multicast signals.
- Support of PTP on the media port with fail-over redundancy for AES67 streams. Supports both AES67 and SMPTE ST 2059 profiles
- Support of DiffServ for network traffic provides categorization of flows into QoS classes
- Compatible with Densité 3, 3+ and GV Node platforms.
- Integrates with iControl and GV Convergent SDN control frameworks.
- TICO 4K 1-wire option (not supported in this release – will be supported in v2.3)

1.3 Functional Block Diagrams

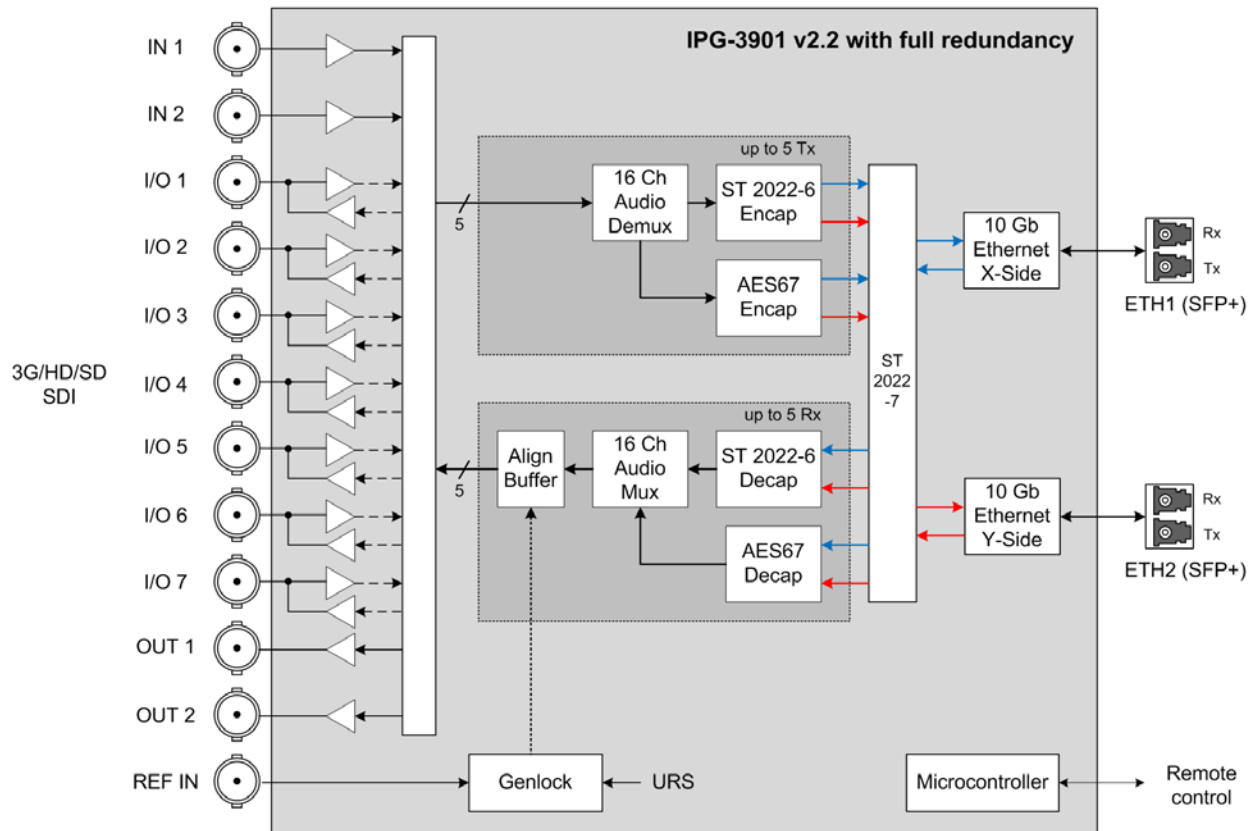

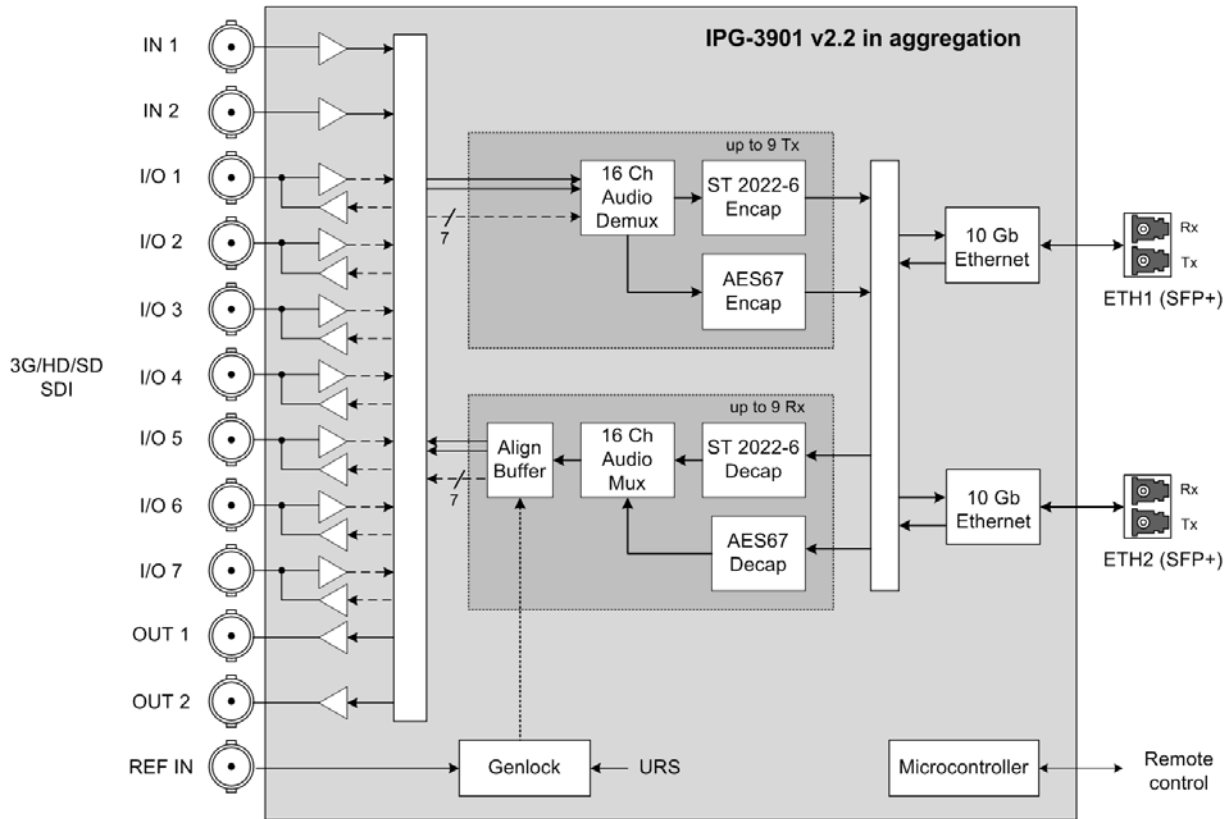

Figure 1-1 IPG-3901 Functional Block Diagram – Redundancy and Aggregation modes

1.4 Front Card-edge Interface

The front card-edge of the IPG-3901 incorporates two elements:

- [Status LED](#) (see section 3.2)
- [Select Button](#) (see section 4)

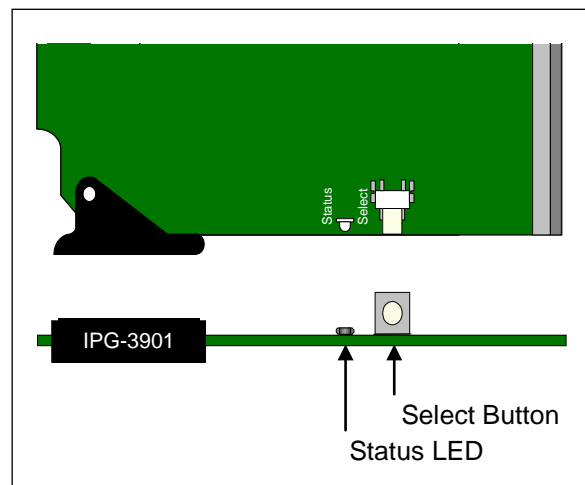

Figure 1-2 Front card-edge layout

2 Installation

2.1 Installation of Rear Connector Panels

Grass Valley Densité-series cards are each associated with a rear connector panel, which must be installed in the Densité frame before the card can be inserted.

The IPG-3901 card is designed to fit into Grass Valley's Densité-3 and Densité 3+ frames. Two different rear connector panels are available:

- IPG-3901-3TRP Triple-slot-width panel for Densité-3
- IPG-3901-3+DRP Double-slot-width panel for Densité-3+FR1 and Densité-3+FR4

See [section 2.3](#) for details of the signal connections available on these panels.

All cards and rear panels can be installed with the frame power on. The card has connectors that plug into a mid-frame mother board for distribution of power and for connection to the controller card, and a second connector that plugs directly into the rear connector panel for input and output.



The rear connector panel must be installed with the card out of the frame.

- To remove an existing card from the slot, tilt the swivel handle on the front of the card to lever the connectors apart, then use the handle to pull the card straight out of the slot.

To install the connector panel:

1. If a card is installed in the slot whose rear panel is being changed, remove it as described above.
2. Remove the existing panel (either blank or belonging to an existing card that is being changed) by releasing the captive screw(s) at the bottom (Densité 3 or Densité 3+ FR4) or side (Densité 3+ FR1) of the panel.
3. Position the new panel and secure it in place with the captive screw(s) at the bottom or side.

2.2 IPG-3901 Card Installation

Once a matching rear connector panel is in place, install the IPG-3901 card as follows:

1. Open the front panel of the frame.
2. Slide the IPG-3901 card into the slot and push gently on the handle to seat the connectors.
 - When using a triple-slot-width rear panel in a Densité-3 frame, the card should be inserted into the rightmost of the three slots.
 - When using a double-slot-width rear panel in a Densité-3+ FR1 frame, the card should be inserted into the lower of the two slots.
 - When using a double-slot-width rear panel in a Densité-3+ FR4 frame, the card should be inserted into the rightmost of the two slots.

Inserting the card into the wrong slot will not damage the card, and will be flagged by the on-card status LED flashing red to indicate that there is no connection to the rear panel.

3. Close the front door of the frame.

2.3 Rear Panels and Connectors

2.3.1 Images of Rear Panel Connectors

The two available rear panels are shown in the figure. Details of the inputs and outputs are described below.

NB – references to MADI on the labels for I/O 1, 3, 4 and 7 are for future use.

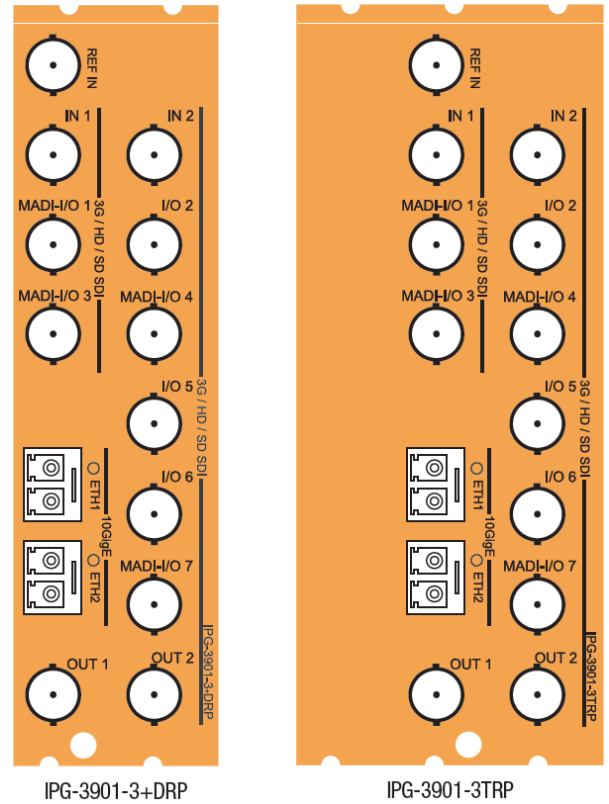

Figure 2-1 IPG-3901 Rear Panels

2.3.2 Summary of rear panel connections

IPG-3901-3TRP		
IPG-3901-3+DRP		
Double-slot-width panel for Densité 3+ FR1 and FR4 frames	◆	
Triple-slot-width panel for Densité 3 frame		◆
CONNECTORS		
Reference IN	1	1
3G/HD/SD SDI IN	2	2
3G/HD/SD SDI OUT	2	2
3G/HD/SD SDI I/O configurable	7	7
10 GigE Ethernet on fiber (SFP+)	2	2

2.3.3 Details of rear panel connections

REF IN – External reference

Connect an NTSC or PAL reference signal (SMPTE 170M / SMPTE 318M / ITU 624-4 black burst)

3G/HD/SD IN – Serial digital 3G/HD/SD inputs

Connect serial digital video signals, conforming to the SMPTE 425M standard for 3G input signals, SMPTE 292M standard for HD input signals or SMPTE 259M standard for SD input signals, to the connectors labeled **3G/HD/SD IN 1 and IN 2**.

3G/HD/SD OUT – Serial digital video outputs

The IPG-3901 provides two 3G/HD/SD SDI video outputs on the connectors labeled **3G/HD/SD OUT 1 and 2**. The SDI video signal conforms to the input standard. The same signal is carried on both outputs.

3G/HD/SD SDI I/O – Serial digital 3G/HD/SD input or output (configurable)

Seven configurable I/O are provided. The SDI signal requirements are the same as those for the dedicated inputs and outputs as described above.

10 GbE ETH – 10 GigE Ethernet on fiber (SFP+ Interfaces)

Two 10 Gb Ethernet interfaces (each with Tx and Rx) on optical fiber or twinax cable. SFP+ modules and matching fiber or electrical connectors are required for the interface.

3 User Interface

3.1 Control options

The IPG-3901 can be controlled in two different ways:

- The local control panel and its push-buttons can be used to move through a menu of status reports (see [section 4](#)).
- Grass Valley's iControl system can be used to access the card's operating parameters from a remote computer, using a convenient graphical user interface (GUI) (see [section 5](#)).

3.2 Card-Edge Status LED

The status monitor LED is located on the front card-edge of the IPG-3901, and is visible through the front access door of the DENSITÉ 3 frame. This multi-color LED indicates the status of the IPG-3901 by color, and by flashing/steady illumination.

The chart shows how the various error conditions that can be flagged on the IPG-3901 affect the LED status.

- If a cell is gray, the error condition cannot cause the LED to assume that status
- If more than one LED status is possible for a particular error condition, the status is configurable.
See [Alarm Config Panel](#) for details.
- The factory default status, if available, is shown by a ⚙



The LED will always show the most severe detected error status that it is configured to display, and in the chart error severity increases from left to right, with green representing no error/disabled, and flashing red the most severe error.

If the LED is Flashing Yellow, it means that the card is selected for local control using the Densité frame's control panel. See [section 4](#) for details.

Error Condition	LED Status			
	Green	Yellow	Red	Flashing Red
Hardware failure – cooling fans				⚙
Wrong or missing Rear				⚙
Ethernet Port 1 Link Status			⚙	
Ethernet Port 2 Link Status	⚙			
Internal test pattern enabled		⚙		
Overall Gateway Status			⚙	

4 Local control using the Densité frame control panel

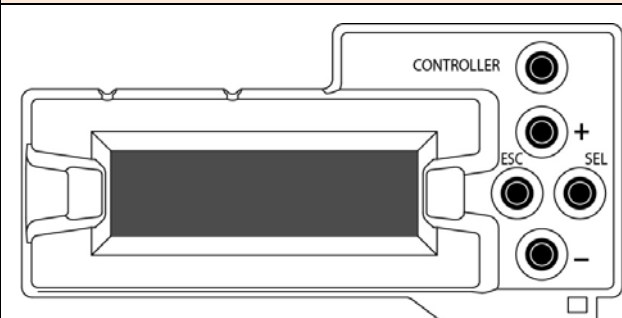
There are two types of local control panel:

Panel type	Frame models	Appearance
Physical	Densité-3, Densité-3+FR1,	
Touch screen	Densité 3+FR4, GV Node	

The local control panel is fastened to the front of the controller card.

- The physical panel is accessed by opening the front door of the frame.
- The touch screen panel is accessed through an aperture in the frame door.

The panel consists of a display capable of displaying two lines of text, each 16 characters in length, and four pushbuttons. The functionality of the pushbuttons is as follows:

[+] [-] Used for menu navigation and value modification

[SELECT] Gives access to the next menu level. When a parameter value is shown, pushing this button once enables modification of the value using the [+] and [-] buttons; a second push confirms the new value

[ESC] Cancels the effect of parameter value changes that have not been confirmed; pushing [ESC] causes the parameter to revert to its former value.

Pushing [ESC] moves the user back up to the previous menu level. At the main menu, [ESC] does *not* exit the menu system. To exit, re-push the [SELECT] button for the card being controlled.

If no controls are operated for 30 seconds, the controller reverts to its normal standby status, and the selected card's STATUS reverts to its normal operating mode.

To assign the local control panel to the IPG-3901:

- Physical Panel: Push the SELECT button on the IPG-3901 card edge (see Section 1.4)
- Touch-screen panel: In the home screen, touch the virtual button corresponding to this IPG-3901

The STATUS LED on the IPG-3901 flashes yellow, and the touch-screen displays the IPG-3901 menu.

Use the control panel buttons to navigate through the menu, as described above.

- The complete menu structure is shown in [ANNEX 1 – Local Menu](#), beginning on page 48.

5 Remote control using iControl

The IPG-3901 can be remotely controlled using Grass Valley's iControl system.

- This manual describes the control panels associated with the IPG-3901 and their use.
- Please consult the iControl User's Guide for information about setting up and operating iControl.

In iControl Navigator or iControl Websites, double-click on the IPG-3901 icon to open the control panel.

5.1 The iControl graphic interface window

The basic window structure for the IPG-3901 is shown in figure 5.1. The window identification line gives the card type (IPG-3901) and the slot number where the card is installed in its Densité frame.

There are four main sections in the window itself, as identified in the figure:

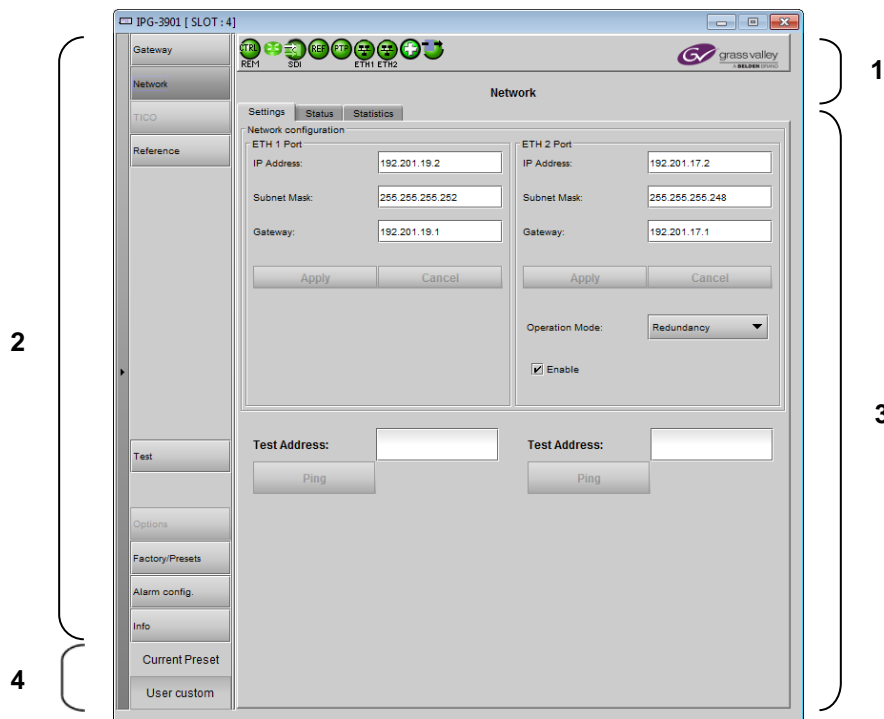

Figure 5-1 IPG-3901 iControl graphic interface window

Section 1. The top section displays nine icons on the left. These icons report different statuses such as card communication status, gateway status, health status, and card operation mode.



Icon # 1 2 3 4 5 6 7 8 9

Move the mouse over an icon and a status message appears below the icon providing additional information. If there is an error, the error status message appears in the message area without mouse-over.









- If there are multiple errors, the error messages cycle so all can be seen.

- The icon whose status or error message is shown is highlighted with a mauve background.

The table below describes the various status icons that can appear, and how they are to be interpreted.

- In cases where there is more than one possible interpretation, read the error message in the iControl window to see which applies.

Table – iControl Status Icon interpretation

Icon #1 – Manual Card Configuration	
 (green)	Remote card control activated. The iControl interface can be used to operate the card.
 (yellow)	Local card control active, The card is being controlled using the Densité frame control panel, as described in section 4 . Any changes made using the iControl interface will have no effect on the card.
Icon #2 – Gateway status	
 (green)	All gateways are OK.
 (red)	At least one gateway is down.
Icon #3 – SDI Input Status	
 (green)	All SDI inputs detected and valid.
 (red)	At least one SDI input is in error. Reference mismatch. Video/TRS error.
Icon #4 – Reference Status	
 (green)	Reference present, supported and locked.
 (red)	Reference missing. Unsupported format or format mismatch. Not locked.
 (gray)	No reference.

Icon #5 – PTP Status	
 (green)	Selected PTP (ETH1 or ETH2) present, valid and locked
 (red)	Selected PTP not present Selected PTP not valid Selected PTP not locked
Icon #6 – ETH1 Status	
 (green)	IP link up and active.
 (red)	No link (port down).
Icon #7 – ETH2 Status	
 (green)	IP link up and active.
 (red)	No link (port down).
 (gray)	Ethernet port not used.
Icon #8 – Health Monitoring	
 (green)	Hardware OK.
 (red)	Hardware Health Monitoring (Hardware fault detected). If this icon appears flashing red, you need to call Technical Support
Icon #9 – Operation Mode	
 (green)	Operation mode: process – normal processing of the input signal.
 (yellow)	Operation mode: Enabled, but no signal to process.
 (yellow)	Operation mode: TEST – color bar and audio test tones enabled on at least one gateway.

Section 2. The left portion of the window contains selection buttons for all of the individual panels, which become highlighted when they are selected. The main window section (3) then displays the selected panel, all of which are described in detail below.

Section 3. The main section displays the panel selected in section 2. It may contain multiple tabs to access any appropriate sub-panels.

Section 4. The lower left corner of the window identifies the Preset currently in use or “Custom” if none is applicable.

5.2 Gateway panel

The Gateway panel provides resources for configuring and managing the gateways on the IPG-3901.

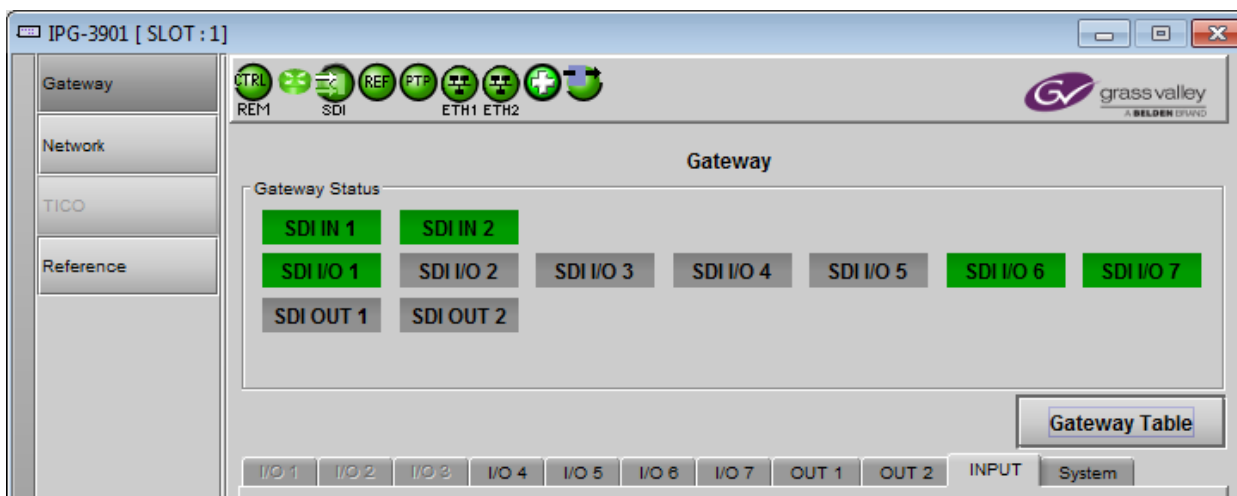

Figure 5-2 Gateway panel – upper portion

The *Gateway Status* icons at the top of the panel show the current status of all eleven gateways on the IPG-3901:

- Top row: the two SDI IN gateways
- Middle row: the seven configurable gateways (SDI IN or SDI OUT)
- Bottom row: the two SDI OUT gateways

Click the **Gateway Table** button to open the pop-up *Gateway Config* window

5.2.1 Gateway Config window

This window shows the current configuration and status of all gateways on the card, and provides controls to modify their settings.

Gateway	Dir.	SDI I/O	Str. Address	Str. Port	IGMPv3 Source	Format	P. ETH	En.
SDI IN 1 GATEWAY 1	→	525i	239.111.32.10	10000	-	SD	ETH1	<input checked="" type="checkbox"/>
			239.111.32.11	10000	-		ETH2	<input checked="" type="checkbox"/>
			239.111.32.12	5004	-	125 usec, 2ch, L...	ETH1	<input checked="" type="checkbox"/>
			239.111.32.13	5004	-		ETH2	<input checked="" type="checkbox"/>
SDI IN 2 GATEWAY 2	→	No signal	0.0.0.0	10000	-	HD	ETH1	<input type="checkbox"/>
			0.0.0.0	10000	-		ETH2	<input type="checkbox"/>
			0.0.0.0	5004	-	125 usec, 16ch, ...	ETH1	<input type="checkbox"/>
			0.0.0.0	5004	-		ETH2	<input type="checkbox"/>
SDI I/O 1 GATEWAY 3	←	No signal	239.111.31.10	10000	0.0.0.0	HD	ETH1	<input type="checkbox"/>
			239.111.31.11	10000	0.0.0.0		ETH2	<input type="checkbox"/>
			239.111.31.92	5004	0.0.0.0	125 usec, 8ch, L...	ETH1	<input type="checkbox"/>
			239.111.32.13	5004	0.0.0.0		ETH2	<input type="checkbox"/>
SDI I/O 2 GATEWAY 4	←	No signal	239.111.31.10	10000	0.0.0.0	HD	ETH1	<input type="checkbox"/>
			239.111.31.11	10000	0.0.0.0		ETH2	<input type="checkbox"/>
			239.111.31.82	5004	0.0.0.0	125 usec, 8ch, L...	ETH1	<input type="checkbox"/>
			239.111.32.13	5004	0.0.0.0		ETH2	<input type="checkbox"/>
SDI I/O 3 GATEWAY 5	←	No signal	239.111.31.10	10000	0.0.0.0	HD	ETH1	<input type="checkbox"/>
			239.111.31.11	10000	0.0.0.0		ETH2	<input type="checkbox"/>
			239.111.31.72	5004	0.0.0.0	125 usec, 8ch, L...	ETH1	<input type="checkbox"/>
			239.111.32.13	5004	0.0.0.0		ETH2	<input type="checkbox"/>
SDI I/O 4 GATEWAY 6	←	No signal	239.111.31.10	10000	0.0.0.0	HD	ETH1	<input type="checkbox"/>
			239.111.31.11	10000	0.0.0.0		ETH2	<input type="checkbox"/>
			239.111.31.62	5004	0.0.0.0	125 usec, 8ch, L...	ETH1	<input type="checkbox"/>
			239.111.32.13	5004	0.0.0.0		ETH2	<input type="checkbox"/>
SDI I/O 5 GATEWAY 7	←	1080i59.94	239.111.31.10	10000	0.0.0.0	HD	ETH1	<input checked="" type="checkbox"/>
			239.111.31.11	10000	0.0.0.0		ETH2	<input checked="" type="checkbox"/>
			239.111.31.12	5004	0.0.0.0	125 usec, 8ch, L...	ETH1	<input checked="" type="checkbox"/>
			239.111.31.13	5004	0.0.0.0		ETH2	<input checked="" type="checkbox"/>
SDI I/O 6 GATEWAY 8	←	1080i59.94	239.111.31.10	10000	0.0.0.0	HD	ETH1	<input checked="" type="checkbox"/>
			239.111.31.11	10000	0.0.0.0		ETH2	<input checked="" type="checkbox"/>
			239.111.31.22	5004	0.0.0.0	125 usec, 8ch, L...	ETH1	<input checked="" type="checkbox"/>
			239.111.31.23	5004	0.0.0.0		ETH2	<input checked="" type="checkbox"/>
SDI I/O 7			239.111.31.30	10000	0.0.0.0	HD	ETH1	<input checked="" type="checkbox"/>

Figure 5-3 Gateway Config table

The contents of the window are affected by two settings made in other panels.

ETH2 Operation Mode (see [Section 5.3.1 - Network Config Panel - Settings tab](#))

Disabled	All gateways use ETH1 port.
Aggregation	ETH port for each gateway is selectable – ETH1 or ETH2.
Redundancy	Each gateway uses both ETH1 and ETH2 with identical stream addresses.

TICO Status (see [Section 5.5 - TICO Panel](#))

TICO option not activated.	This Gateways window shows the 11 gateways associated with the 11 SDI I/O available on the rear panel. No TICO information is displayed.
----------------------------	--

TICO option activated.	Two additional TICO gateways are shown at the bottom of the table. They will be configured as ENC or DEC depending on the TICO model in use.																
	<table border="1"> <tr> <td><input type="checkbox"/></td> <td>TICO 1 - ENC TICO ENC 1</td> <td>→</td> <td>0.0.0.0</td> <td>10000</td> <td>-</td> <td>ETH1</td> <td>3G</td> </tr> <tr> <td><input type="checkbox"/></td> <td>TICO 2 - DEC TICO DEC 2</td> <td>←</td> <td>0.0.0.0</td> <td>10000</td> <td>0.0.0.0</td> <td>ETH1</td> <td>3G</td> </tr> </table>	<input type="checkbox"/>	TICO 1 - ENC TICO ENC 1	→	0.0.0.0	10000	-	ETH1	3G	<input type="checkbox"/>	TICO 2 - DEC TICO DEC 2	←	0.0.0.0	10000	0.0.0.0	ETH1	3G
<input type="checkbox"/>	TICO 1 - ENC TICO ENC 1	→	0.0.0.0	10000	-	ETH1	3G										
<input type="checkbox"/>	TICO 2 - DEC TICO DEC 2	←	0.0.0.0	10000	0.0.0.0	ETH1	3G										
TICO enabled.	Depending on the TICO model in use, and whether an ENC or DEC is enabled ON, as many as 8 of the 11 original gateways are reserved for TICO Link I/O, and cannot be configured in this window. See TICO link assignment table for detailed information.																

Enter data and configure settings as shown in this figure:

OPERATING MODE

Gateway	Dir.	SDI I/O	Str. Address	Str. Port	IGMPv3 Source	Format	P. ETH	En.	
Aggregation SDI I/O 6 GATEWAY 8	←	1080i59.94	239.111.7.30	10030	0.0.0.0	HD	ETH1	<input checked="" type="checkbox"/>	SMPTE 2022-6
			239.111.7.33	5004	0.0.0.0	125 usec, 2ch, L...	ETH2	<input checked="" type="checkbox"/>	AES-67
Redundancy SDI IN 1 GATEWAY 1	→	1080i59.94	239.111.7.10	10010	-	HD	ETH1	<input checked="" type="checkbox"/>	SMPTE 2022-6
			239.201.34.10	10010	-		ETH2	<input checked="" type="checkbox"/>	
			234.111.7.11	5004	-	1 msec, 2ch, L24	ETH1	<input checked="" type="checkbox"/>	AES-67
			234.110.6.11	5004	-		ETH2	<input checked="" type="checkbox"/>	

Color indicates status

Text gives format and status message

Click to select port (aggregation mode only)

Type addresses directly into the data boxes

Click to select gateway direction (SDI I/O gateways only)

Type the Gateway name directly into the panel.

Click to select format

Click to enable the streaming format

Gateway Name

Each Gateway (except the TICO gateways) is linked to a physical SDI I/O via a connector on the rear panel. In the **Gateway** column, we have the physical SDI I/O name on the 1st line and the gateway name on the 2nd line. The gateway name can be edited – select the text and type a new name (up to 19 characters).



- Default names are GATEWAY 1 through GATEWAY 11.
- Changed value is pending prior to acceptance

Gateway Direction

The arrow in the **Dir** column shows the direction of signal flow between SDI and IP through the gateway.

- There are two fixed Gateways that convert SDI to IP Stream – SDI IN 1 and SDI IN 2.
- There are two fixed Gateways that convert IP Stream to SDI – SDI OUT 1 and SDI OUT 2.

- The remaining seven Gateways are linked to bi-directional SDI IOs – SDI IN/OUT 1 to 7. For these SDI I/O gateways only – click the data box to see a dropdown allowing you to select the gateway direction.

	SDI-to-IP Gateway (SDI IN)
	IP-to-SDI gateway (SDI OUT)

- TICO ENC gateways are SDI to IP.
- TICO DEC gateways are IP to SDI.

Stream Address:

- When ETH2 is disabled or in Aggregation mode, we only have one IP stream associated with the Gateway.
- When ETH2 Operation mode is set to Redundancy, we have two IP streams associated with the Gateway – Primary Stream and Redundancy stream. The gateway will be linked to the primary stream when it is valid. If the main stream is in error, the gateway will fall back to the redundancy stream. The fallback may generate an error on the SDI output.

Stream Port: Shows the port associated with the stream. Edit the port by selecting the text and typing a new value.

IGMPv3 Source: On IP-to-SDI we have an additional setting: IGMPv3 source. This is used when receiving multicast streams. In this protocol, the card deals with a switch to subscribe to one or many streams that are coming from different IP addresses.

- When receiving multicast streams, the “stream address” is used to talk to a “group” while the “IGMPv3 source” indicates the exact source from which we want to receive the stream.
- When receiving unicast streams, IGMPv3 protocol is not used.
- When this field is set to 0.0.0.0, IGMPv3 protocol will request multicast streams for all sources.

Type directly into the data boxes to enter stream addresses and port numbers.

- Enter values for both SMPTE 2022-6 and AES-67 streams as required.
- Changed value is pending prior to acceptance

Parameter	Values	Default value	Notes
Stream Address (SMPTE 2022-6 and AES-67)	0.0.0.0 to 255.255.255.255	0.0.0.0	<p><u>SDI to IP Stream</u> 255.255.255.255 is refused (not applied). Unicast addresses are accepted. If the ARP is not resolved, it will be highlighted in Orange.</p> <p><u>IP Stream to SDI</u> Multicast addresses are accepted (224.0.0.0 through 239.255.255.255). Only ETH1 IP address and ETH2 IP address are accepted as the Unicast address.</p>
Stream Port (S. Port) (primary and redundancy stream)	0 to 65535	SMPTE 2022-6: 10000 AES-67: 5004	
IGMPv3 Source (primary and redundancy stream)	0.0.0.0 to 255.255.255.255	0.0.0.0	<p>IP to SDI only. This is used when receiving multicast streams. In this protocol, the card deals with a switch to</p>

(SMPTE 2022-6 and AES-67)			<p>subscribe to one or many streams that are coming from different IP addresses.</p> <ul style="list-style-type: none"> When receiving multicast streams, the “stream address” is used to talk to a “group” while the “IGMPv3 source” indicates the exact source from which we want to receive the stream. When receiving unicast streams, IGMPv3 protocol is not used. When this field is set to 0.0.0.0, IGMPv3 protocol will request multicast streams for all sources.
---------------------------	--	--	---

Stream Formats

You may independently enable or disable the two streaming types supported by the IPG-3901, using the EN checkboxes for each gateway:

- SMPTE 2022-6 Video with embedded audio
- AES-67 Multichannel AES audio

SDI-to-IP gateway behavior

Stream Type	EN	Stream settings	SDI input	Stream Output
SMPTE 2022-6	Enable	Valid	Valid	Generated
			Not Valid	Killed
		Not Valid		Killed
	Disable			Killed
AES-67	Enable	Valid	Valid	Generated
			Not Valid	Killed
		Not Valid		Killed
	Disable			Killed

AES-67 Audio

Embedded Audio		AES-67	
SDI Input	Audio Group	IP Stream	Audio Channel
Valid	Present	Generated	Embedded Audio
	Not Present	Generated	Silence
Not valid		Killed	

IP-to-SDI gateway behavior

There is only one SDI output per gateway, and its embedded audio may be sourced from either the SMPTE 2022-6 streaming input or the AES-67 streaming input, depending on the enabled streams. In some cases, silence or no audio groups may be embedded.

SMPTE 2022-6		AES-67		SDI output	
Enable (En)	Stream validity	Enable (En)	Stream validity	Video	Embedded audio
Enable	Valid	Enable	Valid	SMPTE 2022-6	AES-67
			Not Valid	SMPTE 2022-6	Embed silence
		Disable		SMPTE 2022-6	SMPTE 2022-6
	Not Valid	Enable	Valid	SLATE *	AES-67
			Not Valid	SLATE	Embed silence
		Disable		SLATE	None
Disable		Enable	Valid	SLATE	AES-67
			Not Valid	SLATE	Embed silence
		Disable		KILL	KILL

* The SLATE output is specified on the [Gateway-System](#) tab

Profile Selection

Use the pulldown in the **Format** column to select the video and audio formats.

Streaming Format	Available options	Notes
SMPTE 2022-6	SD HD 3G	TICO gateways are forced to 3G.
AES-67	1 msec, 1ch, L24 1 msec, 2ch, L24 250 µsec, 8ch, L24 125 µsec, 2ch, L24 125 µsec, 8ch, L24 125 µsec, 16ch, L24	

ETH port.: This column shows the ETH port on which we are receiving or transmitting an IP stream.

- When the ETH2 port is not used (**ETH2 disabled**) this column is hardcoded to ETH1.
- When the ETH2 port is used to send or receive more IP Streams (**ETH2 Operation mode = Aggregation**), ETH port has to be set to either ETH1 or ETH2.
- When the ETH2 port is used for redundancy (**ETH2 Operation mode = Redundancy**), the primary stream is always received from or sent to ETH1 and the redundant stream is always received from or sent to ETH2

Bandwidth Limitations per ETH Port

Gateways	Stream	Total Stream Limitation	Comments
SDI-to-IP	SMPTE 2022-6	Up to 5 x SD/HD Up to 3 x 3G	3G SMPTE 2022-6 uses twice HD bandwidth
	AES-67	Up to 5	
IP-to-SDI	SMPTE 2022-6	Up to 5 x SD/HD Up to 3 x 3G	3G SMPTE 2022-6 uses twice HD bandwidth
	AES-67	Up to 5	

Changed Values Pending Acceptance

When you have entered new values into the table that do not trigger immediate changes (you can change multiple parameters on different gateways), the changed values are highlighted, and the Apply and Cancel buttons at the top of the table are active.

- Click **Apply**, or **Enter** on your keyboard to accept your changes
- Click **Cancel** to discard your changes and leave the original values unchanged

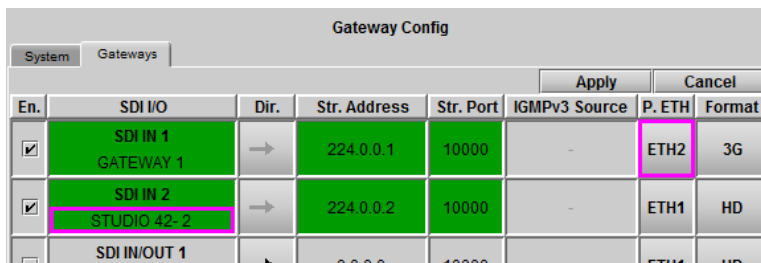

Status

The status of the IP stream is shown by the background color of the Stream Address column.

Gateway Direction	Color	Stream Address Status
IP Stream to SDI	Green	IP stream is valid.
	Red	Invalid IP address. No IP stream. Errors in IP stream. Not TICO for TICO gateways. Missing PTP (for AES-67 only when Syntonize mode is OFF)
	Grey	Gateway disabled.
SDI to IP Stream	Green	SDI is valid. IP Stream settings are valid.
	Orange	Not a valid multicast. Unicast address not resolved by ARP.
	Red	No SDI input. SDI input not valid. SDI scan rate error. SDI format do not match gateway format.
	Grey	Gateway disabled.

The status of SDI I/O is shown by the background color of the SDI I/O column:

Gateway Direction	Color	SDI I/O Status
IP Stream to SDI	Green	IP Stream is valid.
	Red	No IP Stream. IP Stream on error. Incoming SDI Video does not match gateway format. SDI scan rate error.
	Grey	Gateway is disabled.
SDI to IP Stream	Green	SDI input present and valid.
	Red	No SDI input. SDI input not valid. 4K Links on error for TICO gateway. 4K Align on error for TICO gateway.
	Grey	Gateway disabled.

5.2.2 Gateway – Output tab

Each SDI OUT gateway (i.e. OUT 1 and OUT 2, plus each of the configurable gateways I/O 1 through I/O 7 that has been configured as *Output*) has an active tab in the **Gateway** panel.

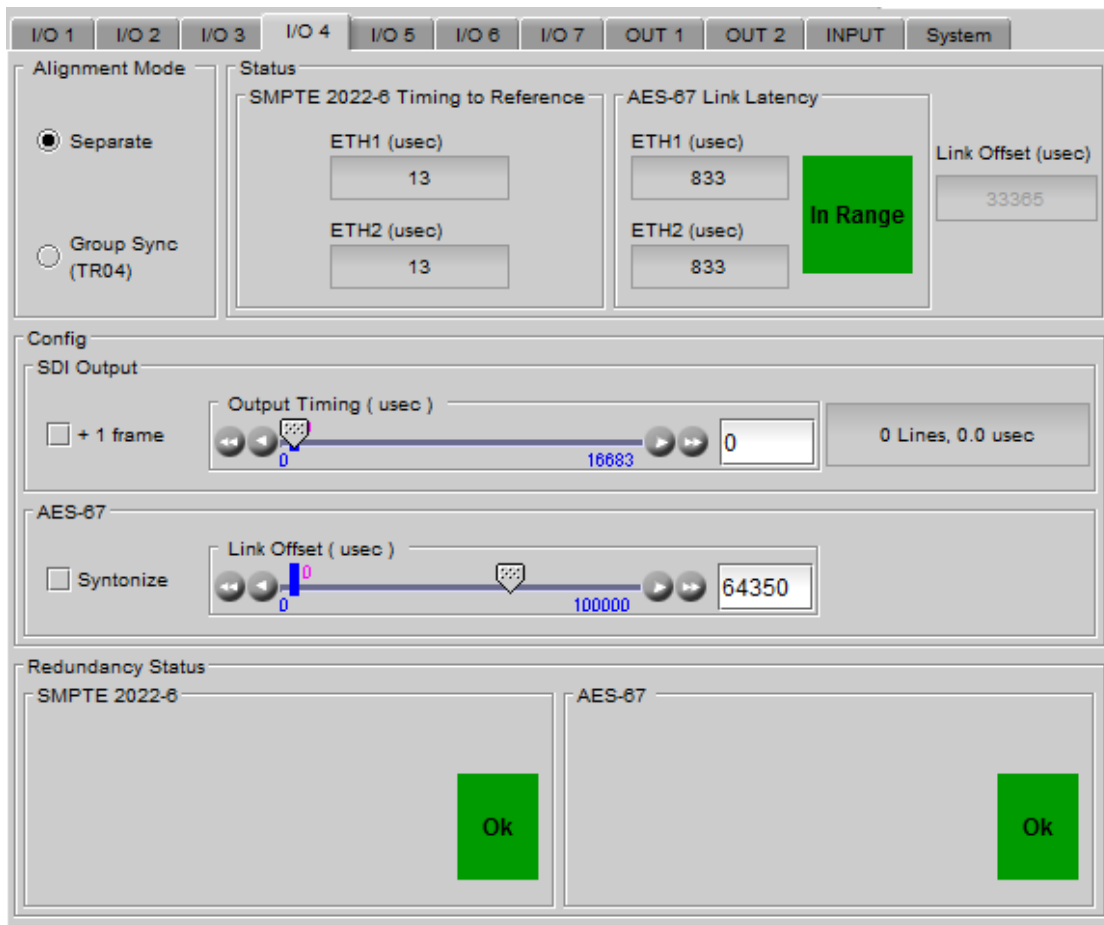

Figure 5-4 Gateway panel - lower portion – SDI output configuration

The controls and indicators in these tabs allow the user to set up audio and video output timing.

Alignment Mode

Two Alignment modes are available, selected by the radio buttons in the top left of the tab:

Alignment Mode	Description
Separate	Video and audio are treated independently of each other and have separate controls. The Link Offset indication is inactive. This is the default mode.
Group Sync (TR-04)	Video and audio are synced together. Both streams must have valid RTP timestamps inserted for correct alignment according to TR-04. Only the Video Config controls are active; the AES-67 controls are disabled.

Status

- SMPTE 2022-6 Timing To Reference

The ETH1 and ETH2 timings are measured by taking the time difference between reference and the marker bits in the S2022-6 streams. These values are displayed as values (in μ secs).

- Measurement less than a field in interlaced format and less than $\frac{1}{2}$ frame for progressive format will be seen as “input is late to Reference ” (positive value).
- Measurement higher than a field in interlaced format and higher than $\frac{1}{2}$ frame for progressive format will be seen as “input is early to reference” (negative value)

The timing of both ETH1 and ETH2 ports is reported, in μ sec. The range varies with the video format:

SDI Format	Range
525, 1080i59	-16683 to 16680 μ sec
720p59, 1080p59	-8342 to 8342 μ sec
625, 1080i50	-20000 to 20000 μ sec
720p50, 1080p50	-10000 to 10000 μ sec

The measured value is only displayed when the both the reference and the 2022-6 stream are present and valid; otherwise N/A is displayed.

Selected Reference	SMPTE 2022-6 (SDI I/O Status)	ETH2 Operation Mode	P. ETH	Input Timing	
				ETH1	ETH2
Present and valid	Present and valid	OFF		Value	“N/A”
		Redundancy		Value	Value
		Aggregation	ETH1	Value	“N/A”
			ETH2	“N/A”	Value
Any Error			“N/A”	“N/A”	
Not present or not valid				“N/A”	“N/A”

- AES-67 Link Latency

The two windows (ETH1 and ETH2) display the time difference between RTP timestamps in the AES-67 streams and the system PTP time. Values are shown in μsec .

PTP	ETH2 Operation Mode	P. ETH	Input Timing	
			ETH1	ETH2
Present and valid	OFF		Value	"N/A"
	Redundancy		Value	Value
	Aggregation	ETH1	Value	"N/A"
		ETH2	"N/A"	Value
Not present or not valid			"N/A"	"N/A"

An **In Range** indicator shows status by color. See the Configuration section below for details.

- Link Offset

The Link Offset value is used when configuring the AES-67 in TR04 mode. See the Configuration section below for details.

Configuration Controls

Two configuration control sections are provided. These are used, in conjunction with the Status data from the ETH1 and ETH2 status displays, to configure the SDI output timing, and to correctly integrate AES-67 audio into the SDI outputs.

Separate Mode – SDI Output Config

Control	Function
Output Timing: Slider	Sets the time at which the video is output with respect to the reference. Range: 0 to 1 field for interlaced formats 0 to 1 frame for progressive formats Default value: 0 Output Timing status. Translates μsec into lines + μsec
+ 1 frame: checkbox	Adds an extra frame to the startup buffer to deal with high-jitter streams; e.g. from server-based systems.

Separate Mode – AES-67

Control	Function
Link Offset: Slider	Sets the time at which audio is output with respect to the PTP time. Range: 0 to 100000 μsec (default is 0 μsec). Adjustable in steps of 1 μsec or 1000 μsec .
Syntonize: checkbox	Minimum Latency mode that over-rides the Link Offset control. Packets are played out after a fixed number of packets. This mode is a debug aid for commissioning purposes only.

Group Sync (TR-04) Mode

Use this mode for TR-04 operation.

- Only the video controls are available; audio controls are disabled.
- This mode requires PTP.

The IPG-3901 measures the timing of the delayed video using its RTP timestamps with respect to the system PTP time. From this it calculates a link offset which is applied to the audio.

- This applied link offset value is displayed in the Status area of the panel, beside the AES-67 link Latency status.

Video and audio are automatically aligned.

5.2.3 How to set up the SDI Output timing on the IPG-3901

SMPTE 2022-6 Timing

You can use the values presented in the ETH1 and ETH2 Status displays, in conjunction with the following information, to calculate the minimum value for the Output Timing slider. If the Output Timing rules shown in the table are not respected, the card will automatically align the SDI output on the next frame of the selected reference (including Output Timing slider).

Internal processing	Frame Duration
SD: 370 μsec	59.94i 33367 μsec
HD: 70 μsec	59.94p 16683 μsec
3G: 44 μsec	50i 20000 μsec
	50p 10000 μsec

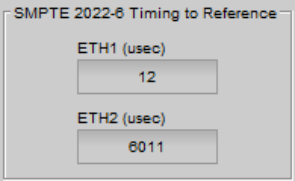
Input Timing to Reference	Output Timing has to follow this rule:	Example 1	Example 2
ETH1 and ETH2 are delayed (positive values)	Output Timing Slider > MAX (ETH1, ETH2) + internal processing	 <p>If video format is 1080i59: Output Timing Slider > 6011 μsec + 70 μsec Output Timing Slider > 6081 μsec</p>	

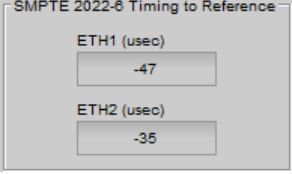
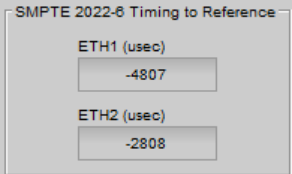
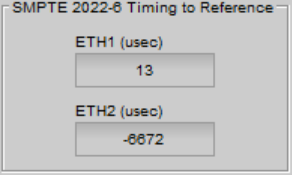
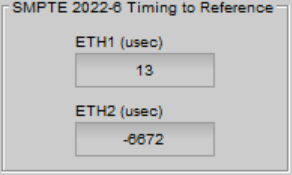
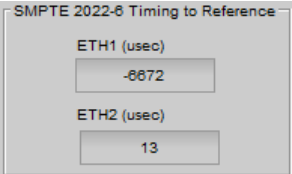
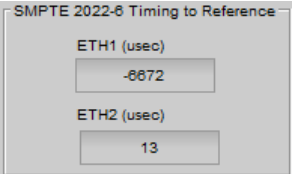
<p>ETH1 and ETH2 are advanced (negative values)</p>	<p>Output Timing Slider > MAX (ETH1, ETH2) + internal processing</p>	 <p>If video format is 1080i59: Output Timing Slider > -35 + 70 μsec Output Timing Slider > 35 μsec</p>	 <p>If video format is 1080i59: Output Timing Slider > -2808 μsec + 70 μsec Output Timing Slider > -2738 μsec Output Timing Slider > 0 μsec (min supported)</p>
<p>ETH1 is delayed and ETH2 is advanced</p>	<p>Output Timing Slider > MAX (ETH1, Frame + ETH2) + internal processing</p>	 <p>If video format is 1080i59: Frame + ETH2 = 33367 μsec + (- 6672 μsec) Frame + ETH2 = 26695 μsec Output Timing Slider > 26695 + 70 μsec Output Timing Slider > 26765 μsec</p>	 <p>If video format is 1080p59A: Frame + ETH2 = 16683 μsec + (- 6672 μsec) Frame - ETH2 = 10011 μsec Output Timing Slider > 10011 + 70 μsec Output Timing Slider > 10081 μsec</p>
<p>ETH1 is advanced and ETH2 is delayed</p>	<p>Output Timing Slider > MAX (Frame + ETH1, ETH2) + internal processing</p>	 <p>If video format is 1080i59: Frame + ETH1 = 33367 μsec + (- 6672 μsec) Frame + ETH1 = 26695 μsec Output Timing Slider > 26695 + 70 μsec Output Timing Slider > 26765 μsec</p>	 <p>If video format is 1080p59A: Frame - ETH1 = 16683 μsec + (- 6672 μsec) Frame - ETH1 = 10011 μsec Output Timing Slider > 10011 + 70 μsec Output Timing Slider > 10081 μsec</p>

AES-67 Timing

You can use the values presented in the ETH1 and ETH2 Link Latency displays, in conjunction with the following information, to calculate the minimum value for the Link Offset.

- The calculation depends on the selected audio profile
- The IN RANGE status display simplifies the adjustment process.

Audio Profile	Packet time	Minimum Processing Delay (= 12 x packet time)
1 msec, 1 ch, L24 1 msec, 2 ch, L24	1 ms	12 msec
125 µsec, 2 ch, L24 125 µsec, 2 ch, L24 125 µsec, 2 ch, L24	125 µsec	1.5 msec
250 µsec, 8 ch, L24	250 µsec	3 msec

A. Separate Mode

Adjust the **Link Offset** slider to meet this criterion:

- Link Offset Slider > Link Latency (MAX ETH1, ETH2) + Minimum Processing Delay

If the IN RANGE status is RED, you must increase the Link Offset slider.

B. TR04 Mode

Observe the **Link Offset** status, and adjust the **Output Timing** slider to meet this criterion:

- Link Offset status > Link Latency (MAX ETH1, ETH2) + Minimum Processing Delay

If the IN RANGE status is RED, you must increase the Output Timing slider.

Note that the IN RANGE status must be GREEN for audio to be inserted in the SDI output.

5.2.4 Gateway – Input tab

Starting with v2.2.3, the user must identify any asynchronous SDI inputs. Output SMPTE 2022-6 on the ETH ports will be flagged

The input detection circuitry in IPG-3901 must be advised when the input signal is asynchronous to the system timing reference. This is because an asynchronous signal will occasionally be nearly in phase with the reference, causing the detection circuitry to lock it, only to have the signal drift away from the reference, unlocking the input circuits. The lock/unlock cycle will raise error messages, and interfere with system operation.

Defining this input as asynchronous allows the system to ignore the occasional in-phase situation. The signal can still pass through the system, and the SMPTE 2022-6 IP output will be flagged to identify the video as asynchronous.

To identify an asynchronous input

1. Select the **Gateway – Input** tab

An active checkbox will be shown for each SDI input – SDI IN 1, SDI IN 2, and any SDI I/O which have been selected as inputs.

2. Select the checkbox for any SDI IN which is known to be asynchronous.



Figure 5-5 Gateway-Input tab: specifying asynchronous SDI inputs

5.2.5 Gateway – System tab



Figure 5-6 Gateway - System

SDI Output on Error: Specify the SDI output behavior when the related gateway is on error.

Behavior													
Output a signal in the appropriate format, with the picture being a full-screen color slate as shown in the sample box.													
The color is configurable:													
<ol style="list-style-type: none"> 1. Click on the color sample to open the Color Selection window. 2. In the Color Selection window, use the sliders, or type directly into the data boxes, to select a color. 													
	<table border="1"> <thead> <tr> <th>Component</th> <th>Range</th> <th>Default</th> </tr> </thead> <tbody> <tr> <td>Y</td> <td>1-254</td> <td>16</td> </tr> <tr> <td>Cb</td> <td>1-254</td> <td>128</td> </tr> <tr> <td>Cr</td> <td>1-254</td> <td>128</td> </tr> </tbody> </table>	Component	Range	Default	Y	1-254	16	Cb	1-254	128	Cr	1-254	128
Component	Range	Default											
Y	1-254	16											
Cb	1-254	128											
Cr	1-254	128											
<ol style="list-style-type: none"> 3. If the selected color is an invalid system color it will be flagged in the Color Selection window and in the color sample box. 4. Select <i>Default</i> to choose the system default color (Black: 12, 128, 128) and leave the Color Selection window open. 5. Select <i>Apply</i> to accept the selected color and leave the Color Selection window open. 6. Select <i>OK</i> to accept the selected color and close the Color Selection window. 7. Select <i>Cancel</i> to close the Color Selection window without making changes. 													

Note – On SDI-to-IP, the IP stream is automatically killed when the related gateway is on error.

5.3 Network panel

5.3.1 Network panel – Settings tab

Network Configuration

Enter the IP Address, Mask and Gateway for the two ethernet ports (ETH1 and ETH2) on the IPG-3901 into the data boxes.

- After any change, you must click *Apply* to confirm the new values, or *Cancel* to leave the existing values unchanged. Pending changes are displayed in red.

Operation Mode: The ETH 2 port is used to provide Redundancy or Aggregation.

- Select the **Enable** checkbox to activate the ETH2 port
- Use the pulldown to select the operation mode:
 - Redundancy
 - Aggregation

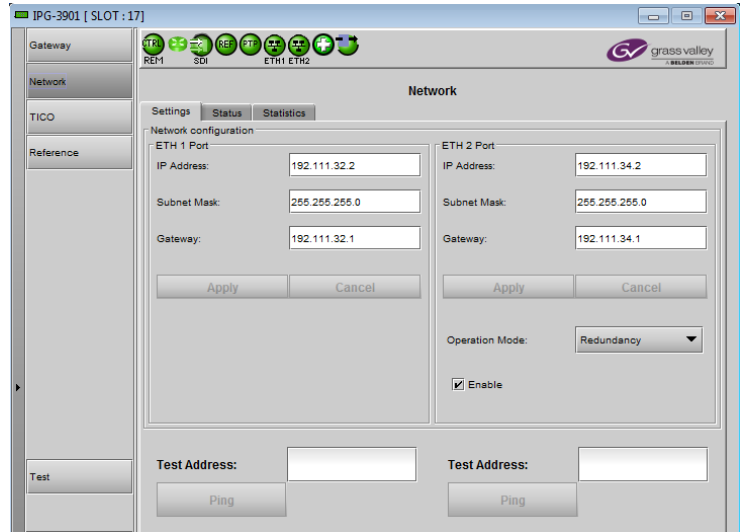

Figure 5-7 Network panel – Settings tab

See [Gateway Config window](#) for more information about the ETH2 Operation mode.

Test Address

Type a proposed destination address into the data box, and click *Ping* to check whether the destination can be seen by this port.

5.3.2 Network panel – Status tab

This tab reports on the status of the ETH1 and ETH2 ports.

Status	Details
Link	The icon indicates the link status: Green – up and valid Grey - down
IP Address	As set in the Settings tab
Subnet Mask	As set in the Settings tab
Gateway	As set in the Settings tab
MAC Address	Each port has a separate MAC address, factory-set and non-configurable.

It also reports the status of SFP modules installed in the IPG-3901 rear panel.

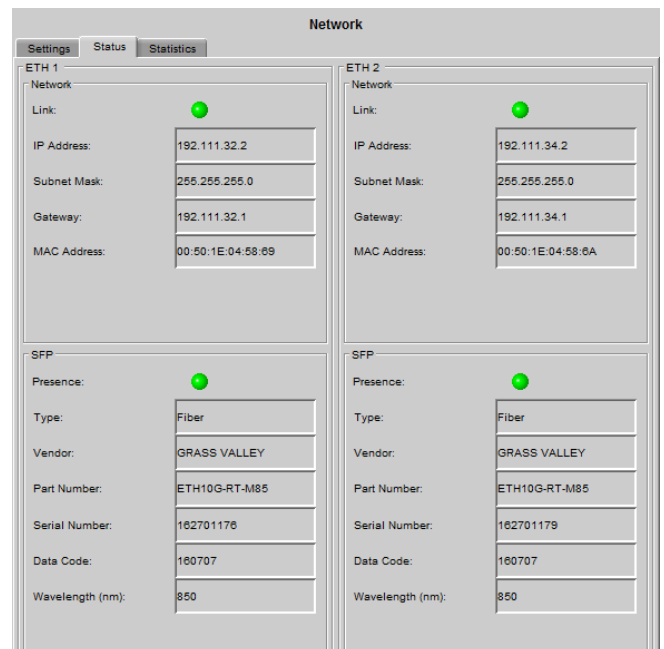

Figure 5-8 Network panel – Status tab

Status	Details
Presence	Green – Supported SFP module detected Grey – No supported SFP module
Type	Fiber or Copper
Vendor	Name
Part Number	Vendor’s part number
Serial Number	#
Data Code	#
Wavelength	Operating wavelength (nm)

There are no operating controls or settings on this tab.

5.3.3 Network Config panel – Statistics tab

This tab displays continuously-updated statistics about the data passing through each of the ethernet ports.

- Packets: The total number of Ethernet packets transmitted and received since the last reset on each port.
- Errors: The total number of Rx and Tx errors detected on each ethernet port since the last reset.

The accumulated statistics can be reset for a fresh start by clicking the *Reset ETH Statistics* button

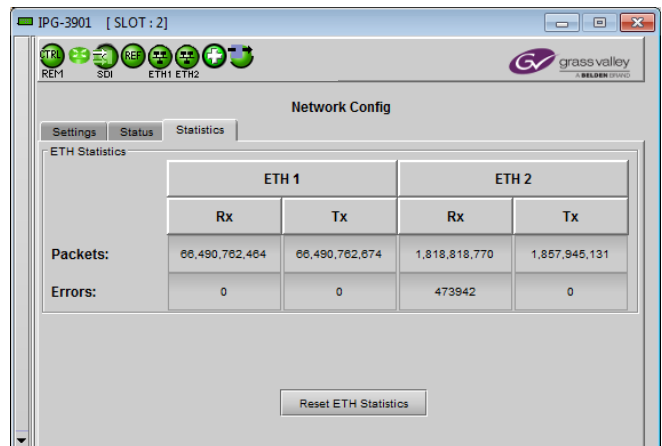

Figure 5-9 Network panel – Statistics tab

5.4 TICO Panel

NOTE – TICO is temporarily *not supported* in this IPG-3901 release. It will be restored in the next release. Please disregard any reference to TICO in this document.

To use TICO as described in this manual, you should downgrade from v2.2.x to v1.3.x

The IPG-3901 incorporates two TICO gateways, which can be configured as encoders and decoders according to the **TICO Model** chart below.

NOTE: The IPG-3901-OPT-TICO option must be activated before you can use the TICO gateways. Learn how to [enable the TICO option](#).

If the option is not activated, this panel will be greyed out and not available, and the TICO gateways will not be shown in the gateway configuration and status panels.

Once the TICO option is active, three different models are available to select.

- Each model includes 11 regular gateways and 2 new gateways for TICO processing.
- Each TICO encoder or decoder uses 4 SDI I/O for its inputs or outputs, so these will be reserved and not available as a regular gateway.

5.4.1 Advanced tab

This tab allows you to select the TICO model you will use with this IPG-3901.

- Click the **Active TICO Model** pulldown and select the desired functionality.

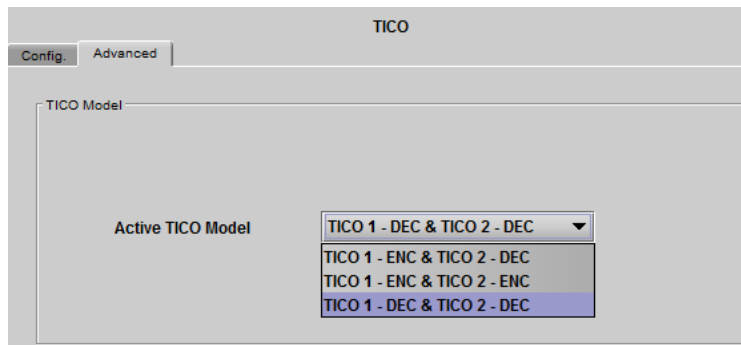

CAUTION – the card will reboot when the TICO model is changed, and the iControl service will be interrupted as well. A pop-up warning will remind you of the consequences of changing the model.

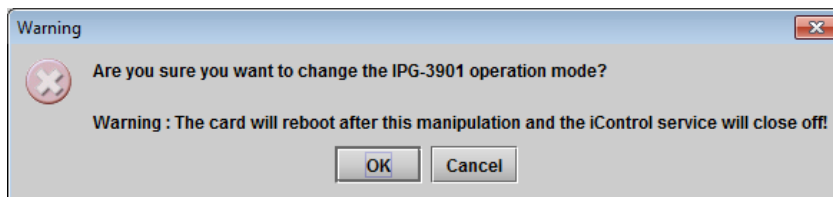

The two TICO gateways are configured according to the selected model:

TICO Model	Gateway Name	Gateway Direction (forced)	Gateway Format (forced)
TICO 1 - ENC & TICO 2 - DEC (default)	TICO 1 - ENC	→	3G
	TICO 2 - DEC	←	3G
TICO 1 - ENC & TICO 2 - ENC	TICO 1 - ENC	→	3G
	TICO 2 - ENC	→	3G
TICO 1 - DEC & TICO 2 - DEC	TICO 1 - DEC	←	3G
	TICO 2 - DEC	←	3G

See [ANNEX 3 – Block Diagrams of TICO Models](#) for functional block diagrams of each of these models.

Each model reserves specific SDI I/Os to use with the TICO encoder or decoder, according to the following table:

SDI I/O	TICO Models		
	TICO 1 - ENC & TICO 2 - ENC	TICO 1 - DEC & TICO 2 - DEC	TICO 1 - ENC & TICO 2 - DEC
SDI IN 1	ENC 1 – 4K Link 1		ENC 1 – 4K Link 1
SDI IN 2	ENC 1 – 4K Link 2		ENC 1 – 4K Link 2
SDI IN/OUT 1	ENC 1 – 4K Link 3	DEC 1 – 4K Link 1	ENC 1 – 4K Link 3
SDI IN/OUT 2	ENC 1 – 4K Link 4	DEC 1 – 4K Link 2	ENC 1 – 4K Link 4
SDI IN/OUT 3	ENC 2 – 4K Link 1	DEC 1 – 4K Link 3	
SDI IN/OUT 4	ENC 2 – 4K Link 2	DEC 1 – 4K Link 4	
SDI IN/OUT 5	ENC 2 – 4K Link 3		
SDI IN/OUT 6	ENC 2 – 4K Link 4	DEC 2 – 4K Link 1	DEC 2 – 4K Link 1
SDI IN/OUT 7		DEC 2 – 4K Link 2	DEC 2 – 4K Link 2
SDI OUT 1		DEC 2 – 4K Link 3	DEC 2 – 4K Link 3
SDI OUT 2		DEC 2 – 4K Link 4	DEC 2 – 4K Link 4

Color key: Encoder inputs Decoder Outputs

The current assignment of SDI I/Os to TICO functions is shown in the [Gateway Status](#) panel and the [Gateways](#) tab of the [Gateway Config](#) panel.

VPIDs on decoder outputs

VPIDs are inserted on all four 4K output links from the TICO decoder. Select the VPID insertion strategy using the VPID pulldown:

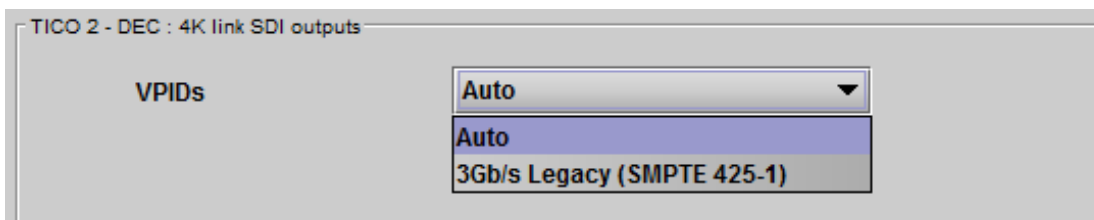

VPID Setting	4K I/O selection on Config tab	
	Quad Split	2-Sample interleave
Auto	SMPTE 425-1	SMPTE 425-5
3Gb/s Legacy	SMPTE 425-1	SMPTE 425-1

Usually, 2-Sample interleave outputs have a different VPID on each link, per SMPTE 425-5. Some downstream equipment may not support this standard, so the use of SMPTE 425-1 VPIDs can be forced by selecting the *3Gb/s Legacy* option in the pulldown.

5.4.2 Config tab

This tab provides some control of the TICO model selected on the Advanced tab.

At the top, you may turn the two TICO encoders or decoders ON or OFF individually.

- When the TICO process is OFF, the SDI I/Os reserved for that process (as shown in the above chart) are freed up and function as normal gateways.
- Any time you try to turn a TICO encoder or decoder ON or OFF, a pop-up window will remind you of the consequences and required actions affecting gateways on the card. For example:

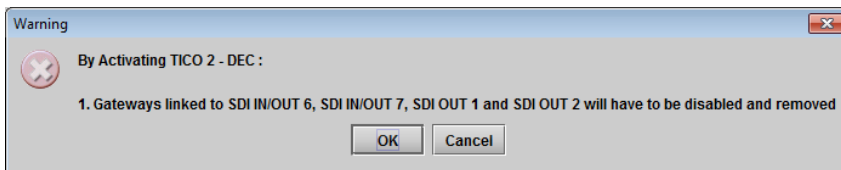

A graphic is displayed for each of the two TICO processes, per the TICO model in use. The graphic shows the current configuration, and reports the status for TICO.

For each TICO encoder or decoder, you must select the format of the four 4K link signals. The choice will depend on the format used by the source or destination equipment. Use the **4K I/O pulldown** to select the appropriate format:

- **Quad split** – (SDQS): the 4K image is split into four full-resolution quadrants, each sent on a single 3G link.
- **2-Sample Interleave** – (2SI): the 4K image is sub-sampled into four full-frame images, each at ½ the vertical and horizontal resolution.

Be careful – this is a manual selection, and errors will occur if the format selected in the pulldown does not match the actual link format.

The TICO encoder/decoder uses 2-Sample Interleave signals, so input/outputs in Quad Split format require an additional conversion process in the signal path, adding some processing delay to the delay inherent in the encoder and decoder.

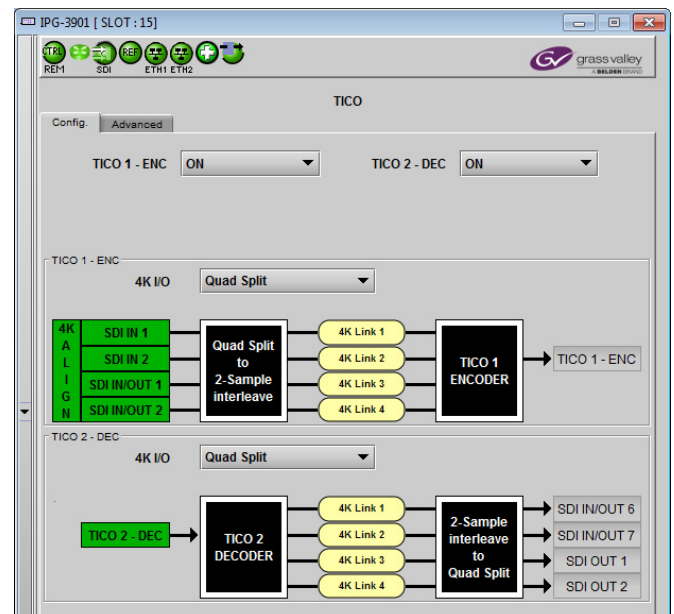

Figure 5-10 TICO panel - Config tab

Process	Added Latency
TICO encoder	4.5 lines
TICO decoder	2.5 lines
Quad Split to 2-Sample Interleave conversion	1 frame

4K Align

The input configuration and status display for TICO encoders includes a segment labeled 4K Align. This monitors the timing of the four link inputs to the encoder.

- The timing difference between 4K links should not exceed 400ns, as per SMPTE ST-425-5.
- If the alignment criterion is not met, no TICO will be sent over IP.

Link Detection

In the case of 2-Sample Interleave inputs to a TICO encoder, incoming SMPTE 425-5 VPIDs on the link inputs enable detection of the link ID, and this is displayed in the panel graphic. The detected links should line up from 1 to 4, top to bottom in the graphic. If they are out of sequence, the cable connections to the input gateways should be checked.

5.4.3 TICO Encoder monitoring

TICO encoders send the encoded signal to IP via the TICO gateway. The IPG-3901 also provides a monitoring signal over IP so that the TICO signal can be monitored without decoding.

Input link 1 to the encoder (after Quad Split to 2-Sample Interleave conversion, if required) is sent to the IP output of its gateway in 3G resolution. Because the link input is 2-Sample Interleave, the monitoring output will be a high-quality, full-screen, sub-sampled version of the original 4K input to the encoder.

TICO	Monitoring Output
Encoder ENC-1	Gateway 1
Encoder ENC-2	Gateway 5

No monitoring is provided for TICO decoders.

5.4.4 Metadata (including audio) when TICO is in use

Metadata is processed as follows when a TICO model is in use:

TICO Encoder
<ul style="list-style-type: none"> • Metadata arriving on 4K link 1 to an encoder is embedded in the outgoing SMPTE 2022-6 stream containing TICO. • Metadata arriving on 4K links 2, 3 and 4 is discarded.
TICO Decoder
<ul style="list-style-type: none"> • Metadata arriving on an SMPTE 2022-6 stream containing TICO will be embedded in the 4K Link 1 output. • 4K Links 2, 3 and 4 will carry no metadata.

5.5 Reference Panel

This panel allows the selection of the reference to be used by the IPG-3901.

5.5.1 Reference Panel - Selection Tab

System-wide Scan Rate: Use the radio buttons to select the scan rate for the system.

Scan rate
59.94 Hz
50 Hz

- Any input not matching this rate will be considered invalid.
- Any reference not matching this rate will be considered a ref-mismatch.

Reference Presence – the icons show the presence and status of the various reference sources. For the external reference, the format is shown in the External Format window.

Icon	Carrier	Format
Grey	None or not valid	N/A
Yellow	Present & valid	Valid, but not supported
Green	Present & valid	Valid and supported

External Format	Supported
NTSC	Yes
PAL	Yes
1080i59HZ	(future)
1080i50HZ	(future)
720p59Hz	(future)
720p50Hz	(future)



Figure 5-11 Reference panel

Reference Source – use the radio buttons to select from the following options:

Reference Source	Description	Default
Auto	This mode selects the first source detected in this order of priority: 1. External Reference input 2. URS 3. Selected Input signal	Auto
External	Selects the signal connected to the rear-panel REF IN connector	
URS (Universal Reference Signal)	(Universal Reference Signal) selects the internal reference from the Densité frame's backplane	

Note – The SDI Outputs (only) are synchronized to the selected reference, but they are not phase-locked

URS Format – use the radio buttons in the URS area to select whether the URS is OFF or ON.

URS	Description			Default
OFF	URS cannot be selected as the reference source, and is ignored by the Auto detection mode			ON
ON	URS is available, and related to the system-wide scan rate :	Scan Rate	URS	
		59.94 Hz	29.97 Hz	
		50 Hz	25 Hz	

5.5.2 Reference Panel – PTP tab

IPG-3901 extracts PTP (Precision Time Protocol) data for streaming (RTP Timestamp) and AES-67 reception. The card still needs an external reference: blackburst or URS





Figure 5-12 Reference panel - PTP tab

Config



Control	Values	Description
Domain Number	Range: 0 to 127 Default: 127	Set the timing domain in which this IPG-3901 and its associated network are operating.
Announce Interval (sec)	0.125 0.250 0.500 1 2 4* 8* 16*	Time interval between Announce messages sent by the Master clock. * These values apply to AES profiles only.
Announce Receipt Timeout Count	Range: 2 to 10 Default: 3	The number of expected announce messages from the Master Clock that this IPG-3901 will miss before an Announce Timeout is flagged.

Status

The PTP status of each ETH port is reported separately.

PTP Presence	Status
Present	
Not present	

PTP presence is also displayed on the dashboard.

Selected PTP	Status
Present & locked	
Not present	
Not locked	

Master ID: Reports the address of the master clock to which this IPG-3901 is synchronized.

Step: Reports whether the timing is being controlled through a 1-step or 2-step process.

5.5.3 PTP Failover

In general, the PTP arriving on ETH1 port is used by the IPG-3901.

If the PTP on ETH1 is lost, the card will enter Flywheel mode, and then switch over to the PTP from ETH2 once the Announce Receipt Timeout has been reached.

The card will switch back to ETH1 using the same process once a valid PTP has been detected on ETH1.

Failover and return should be glitch-free on IP reception and transmission if PTP configuration respects this rule:

$$\text{IPG3901 announce Interval} \times \text{IPG3901 Announce Receipt Timeout} \leq 2\text{s}$$

5.6 Test panel

The test generator can be selected by the user to appear on any output (SDI and stream).

Test Pattern Generator Format

Select the test pattern format using the pulldown.

Format	SD, 720p, 1080i, 1080p
---------------	------------------------

The pattern will be generated at the [System-wide Scan Rate](#), as specified in the *Reference - Selection* panel.

- The current value is displayed in this panel at the top of the table, for reference
- The generator will be synchronous to the REF IN if available; otherwise it will be free-run.

Select the **Test Pattern** checkbox beside a gateway to force the test pattern onto that output.

Select the **Force All** checkbox to force the test pattern onto all outputs.

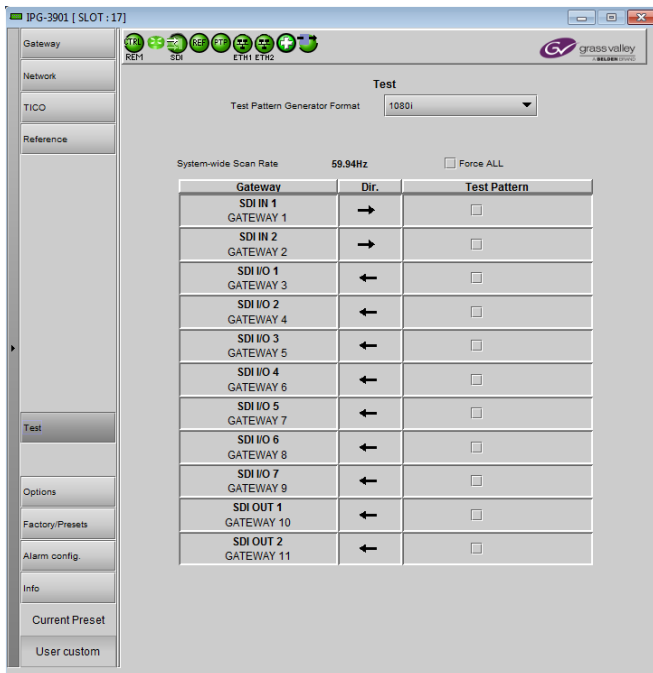

Figure 5-13 Test panel

Note: The test pattern is not applied to TICO encoders or decoders..

5.7 Options Panel

There is one option available for the IPG-3901:

Option Name	Description
IPG-3901-OPT-TICO	TICO encoders and decoders are activated on the card.

To activate this option, you must

- Obtain a license key from Grass Valley.
- Open the *Options* panel.
- Type the license key in the *Enter Key* box.
- Click on **ENABLE OPTION** to enable the option's features.

The TICO option is temporarily **NOT SUPPORTED** in this release.

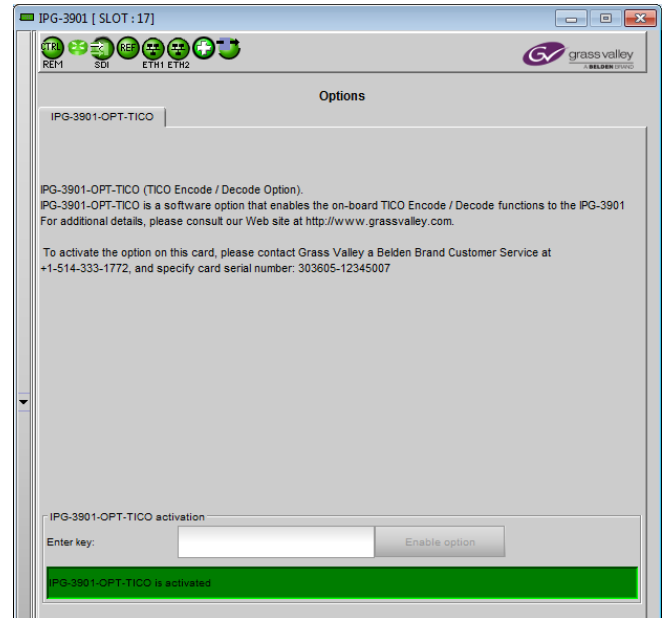

Figure 5-14 Options panel

5.8 Factory/Presets Panel

User Presets

The IPG-3901 has memory registers which can hold up to 5 user-defined parameter settings.

Select any one of the five presets using the Card Preset Select pull-down.

Click **Load** to load the contents of the selected User Preset into the IPG-3901. All parameter settings and values will be replaced by the contents of the selected User Preset.

A confirmation box will pop up to allow you to proceed or cancel the load.

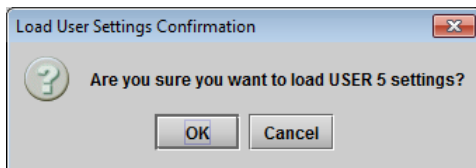

Click **Save** to store the current parameter settings and values from the IPG-3901 into the selected User Preset. The existing contents of the preset will be overwritten. A confirmation box will pop up to allow you to proceed or cancel the save.

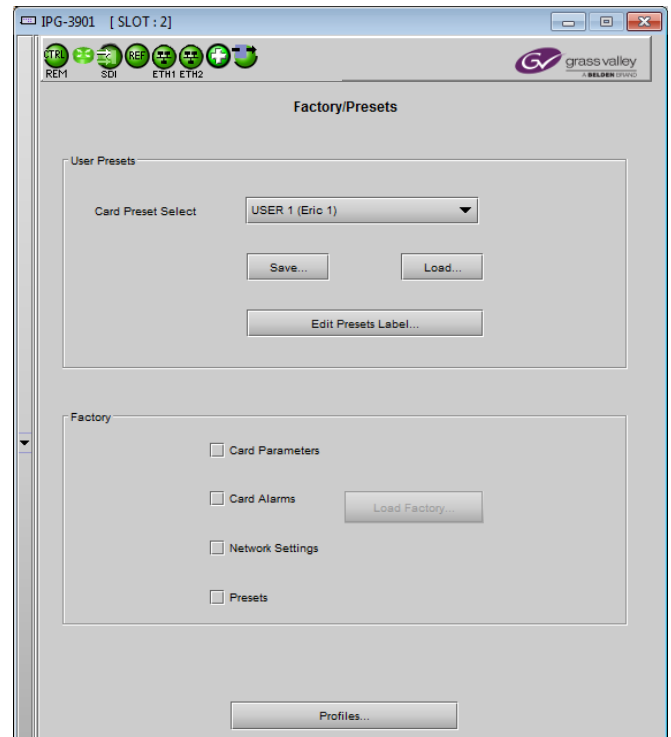
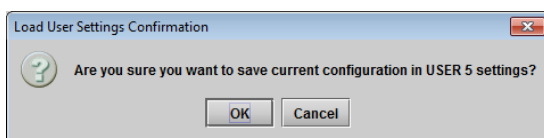
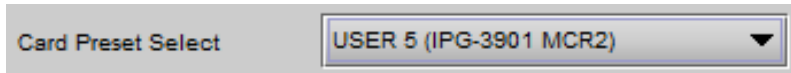

Figure 5-15 Factory/Presets Panel

You can edit the name assigned to each user preset.

- Click *Edit Presets Label* to open the Presets window.
- Double-click on a name in the Label column
- Type a new name in the window.
- Click OK

The text you have entered (up to 16 characters) will be appended to the label name in the selection pulldown



5.8.1 Factory

Clicking the Load Factory button will restore the card to a factory default state. Four checkboxes enable the user to choose whether to include Card Parameters, Card Alarms, Network Settings and Presets in the restoration process. Note – Card Alarms only are reset to factory values; iControl Alarms and GSM alarms are not reset. With reference to the Alarm Configuration panel:

Reset by Load Factory?

Yes No No

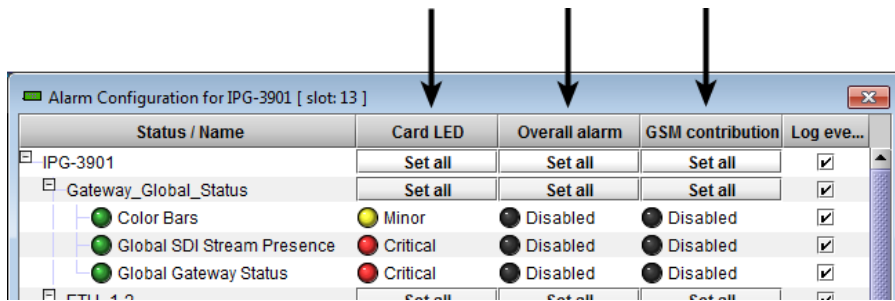

5.8.2 Profiles

Use *Profiles* to save or recover the entire card configuration (including user presets if desired) on an external disk, or to copy it to another IPG-3901 card.

Click on *Profiles* to open the Profile Copy window.

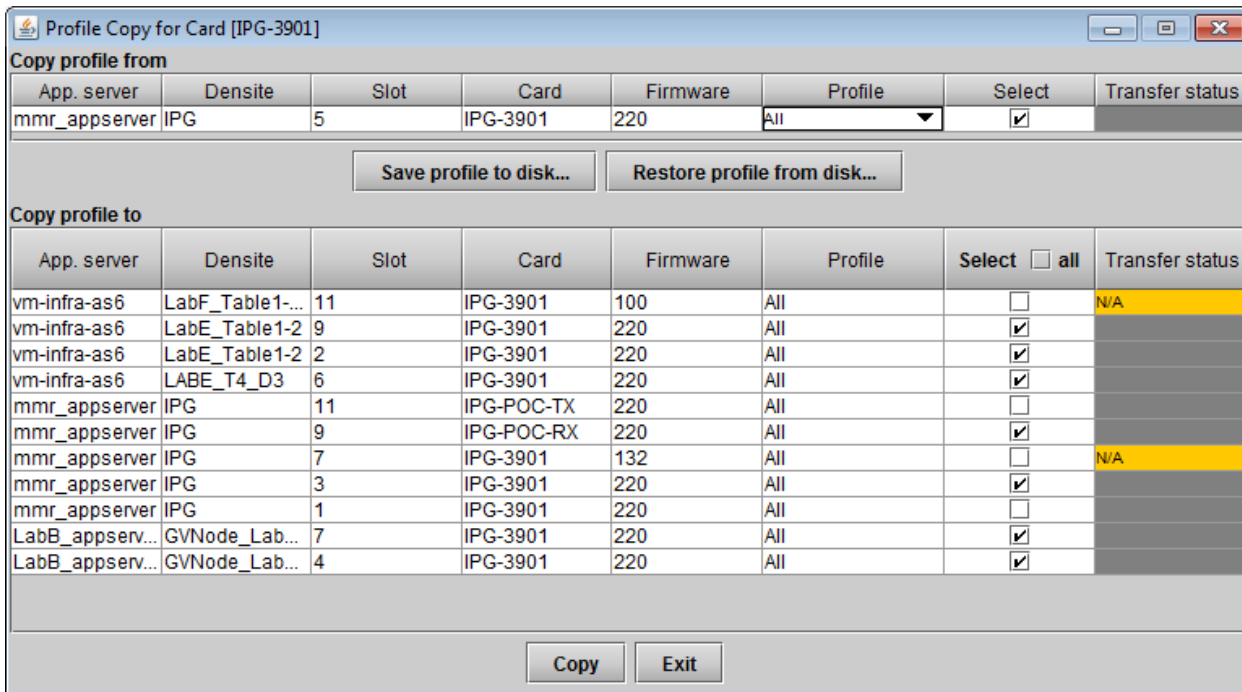

Figure 5-16 Profile Copy for Card

profile from

Copy

This line shows this IPG-3901 card, and identifies it by App server, Densité frame and slot number, card type and firmware version.

The *Profile* column has a pulldown that allows you to select which profiles you will work with, and gives these choices:

- All, Current, User1, User2, User3, User4, User5

Profile	Values	Default
ALL	Current configuration of the card and all presets will be copied or saved on disk	ALL
Current	Only the current configuration of the card is copied or saved on disk	
User1 ...User5	Only the selected preset will be copied or saved on disk	

The *Select* column includes a checkbox (preselected checked) to confirm that you want to work with the current card.

Save Profile to Disk...

After selecting which profiles you want to save, click this button to open a Save dialog allowing you to specify a file name and location to which the selected profiles for this card will be saved.

Hint - It is a good idea to create a folder for these files, because they are not explicitly identified as IPG-3901 profiles, and will be difficult to find and identify if not clearly named and conveniently located.

- Click the save button once the name and location have been identified in the Save box. The Transfer Status box on the right of the *Copy profile from* line will indicate *In progress* against a yellow background.



- If the file is saved correctly, the Transfer Status box will indicate *Succeeded* against a green background.

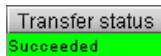

- If the file was not saved for some reason, the Transfer Status box will indicate *Failed* against a red background.

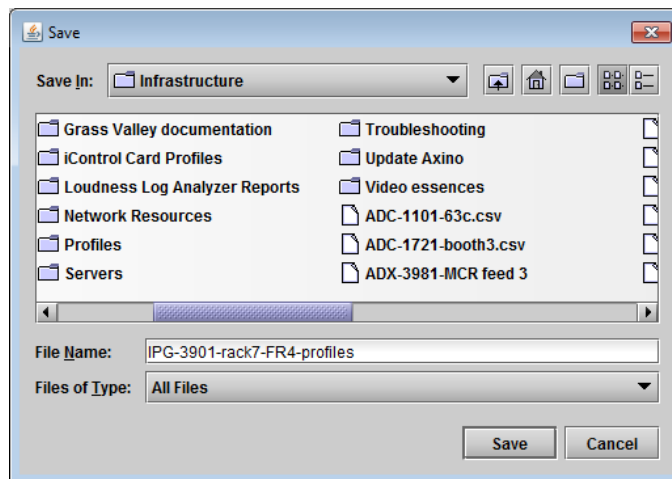
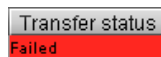

Figure 5-17 Save Profile to Disk dialog

Restore profile from disk...

Click this button to open an *Open* dialog box within which you can locate and select a valid IPG-3901 profile file.

- Click Open to read the contents of the file and to reconfigure this IPG-3901's profiles according to its contents
- While the reconfiguration is in progress, the Transfer Status box on the right of the *Copy profile from* line will indicate *Working* against a yellow background
- When the reconfiguration is complete, the Transfer Status box will indicate *Succeeded* against a green background

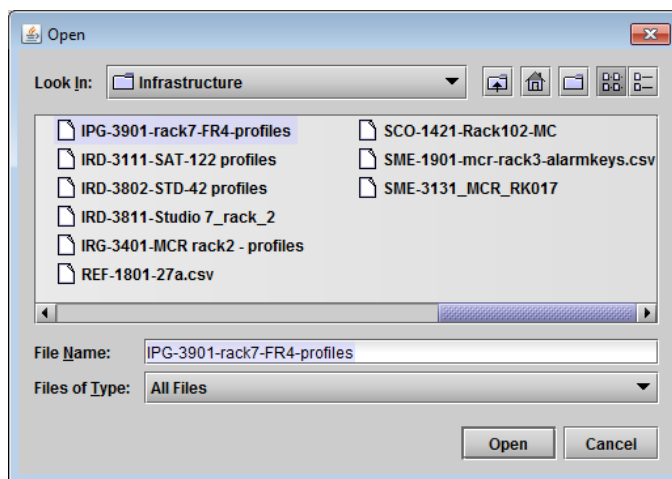

Figure 5-18 Restore Profiles from Disk dialog

On a restore profile from disk, there is no need to select a profile type (ALL, Current, User1 to User5). All the profile contents of the file will be restored.

Copy profile to

This section shows other IPG-3901 cards that are available on the iControl network, each identified by App server, Densité frame and slot number, card type and firmware version.

The *Profile* column shows the same information as is shown for the current card in the *Copy profile from* line, i.e. one of the following:

- All, Current, User1, User2, User3, User4, User5

The *Select* column includes a checkbox to identify which IPG-3901 cards you wish to copy profiles into from the current card.

- For convenience, a *Select all* checkbox is provided in the column header

Click *Copy* to copy the selected profiles from this card into the selected other IPG-3901 cards

- While the profile copy operation is in progress, the Transfer Status box on the right of the *Copy profile to* line will indicate *Working* against a yellow background
- When the profile copy operation is complete, the Transfer Status box on the right of the *Copy profile to* line will indicate *Succeeded* against a green background

Note – the source and destination cards must have the same firmware version, so any destination cards with a different firmware version that are shown in the *Copy profile to* list cannot be selected, and their transfer status is always N/A on a yellow background

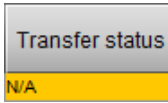

5.9 Alarm Config Panel

This panel allows the alarm reporting of the IPG-3901 to be configured. The panel opens in a new window when the button is clicked, and can be resized if needed.

The panel is organized in columns.

Status/Name

This contains an expandable tree listing all the alarms reported by this IPG-3901 card.

- Each alarm name includes an icon that shows its current status
- Some alarms may be text-only and the alarm status is shown in the name and not by a status icon

The **Card LED**, **Overall Alarm** and **GSM Contribution** columns contain pulldown lists that allow the level of contribution of each individual alarm to the alarm named in the column heading to be set.

- Click on the alarm icon to see the available levels; then click on one to select it.



Card LED

This column allows configuration of the contribution of selected individual alarms to the status LED located on the front card edge. The Card LED status is shown at the bottom of the alarm tree in the Status/Name column.

Overall Alarm

This column allows configuration of the contribution of each individual alarm to the Overall Alarm associated with this card. The Overall Alarm is shown in the upper left corner of the

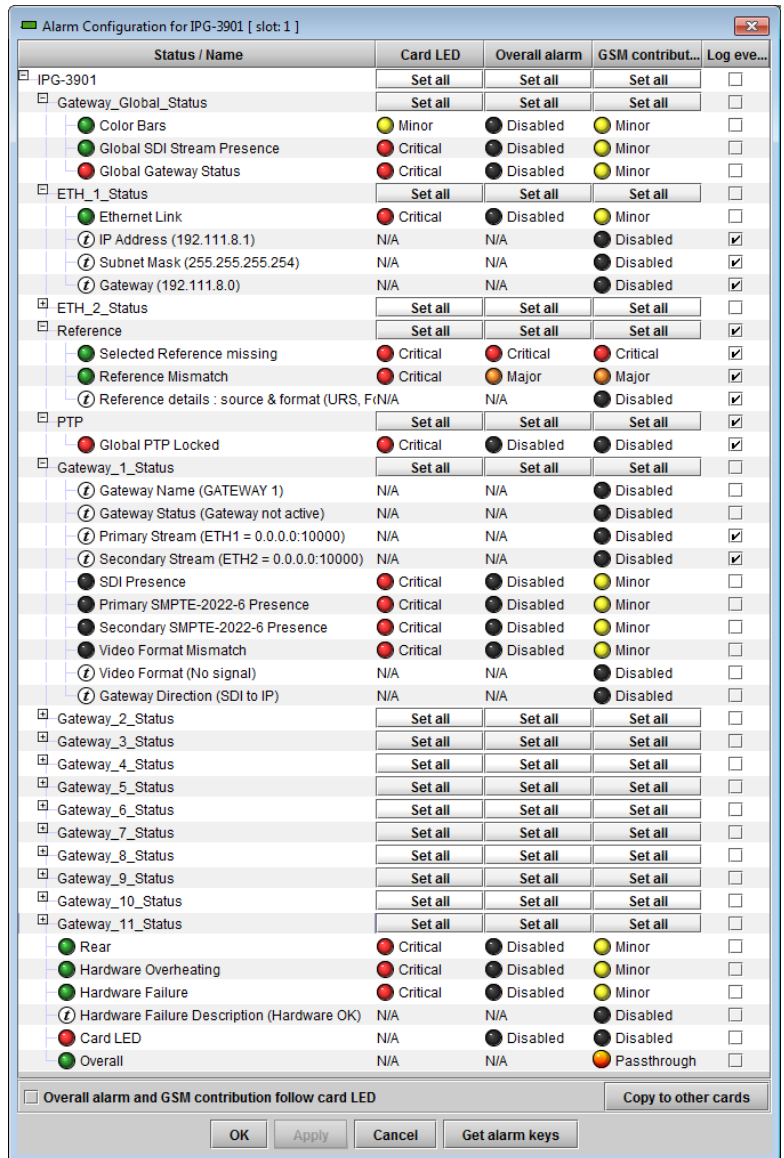

Figure 5-19 Alarm Configuration

iControl panel, and also appears at the bottom of the Status/Name column.

GSM Contribution

This column allows configuration of the contribution of each individual alarm to the GSM Alarm Status associated with this card. GSM is a dynamic register of all iControl system alarms, and is also an alarm provider for external applications. The possible values for this contribution are related to the Overall alarm contribution:





- If the Overall alarm contribution is selected as Disabled, the GSM alarm contribution can be set to any available value
- If the Overall alarm contribution is selected as any level other than disabled, the GSM contribution is forced to follow the Overall Alarm.

Log Events

iControl maintains a log of alarm events associated with the card. The log is useful for troubleshooting and identifying event sequences. Click in the checkbox to enable logging of alarm events for each individual alarm.

Levels associated with these alarms:

The pulldown lists may contain some or all of the following options:

-  Disabled The alarm makes no contribution (black icon)
-  Minor The alarm is of minor importance (yellow icon)
-  Major The alarm is of major importance (orange icon)
-  Critical The alarm is of critical importance (red icon)
-  Passthrough The alarm exists but has no effect (used for text and composite alarms)

Shortcut: if you click in one of the Set All boxes beside a section heading, you will open a pulldown that lets you assign a level to all alarms in that section of the column simultaneously.

Once the alarms are configured, you may accept the changes or discard them:

Overall alarm and GSM contribution follow card LED

Click in the checkbox to force the Overall alarm and GSM contribution to be identical to the Card LED status

- All Overall alarms and GSM contributions for which there is a Card LED alarm will be forced to match the Card LED alarm
- All Overall Alarms and GSM contributions for which there is no Card LED alarm will be forced to Disabled

A warning box will open allowing you to confirm the action, since it will result in changes to the configuration and there is no *undo* function.

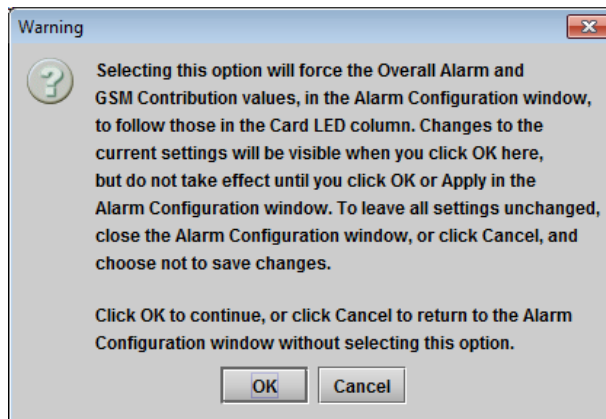

Figure 5-20 Warning for Follow LED change

Copy to other cards

Click this button to open a panel that allows the alarm configuration set for this card to be copied into another IPG-3901 card.

- Select one or more destination cards from the list in the window by clicking in the checkboxes, or all of them by clicking in the *All* checkbox
- Note that when you [copy a profile](#) for this card (see page 38), the alarm configuration is copied along with all the other settings.

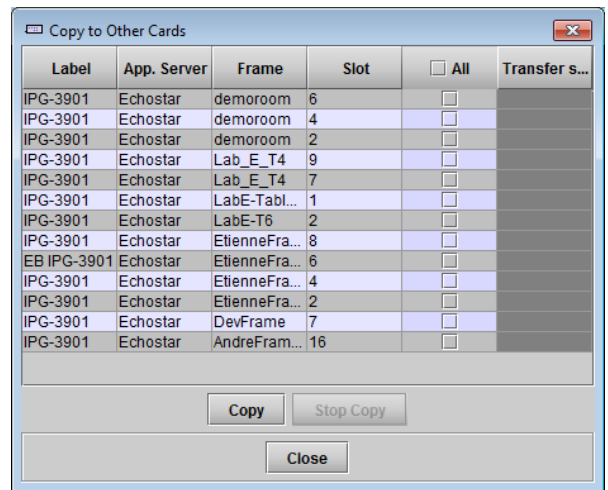

Figure 5-21 Copy to Other Cards window

Get alarm keys

Click this button to open a save dialog where you can save a file containing a list of all alarms on this card and their current values, along with an Alarm Key for each. The alarm keys are useful for system integration and troubleshooting.

- The file is saved in .csv format

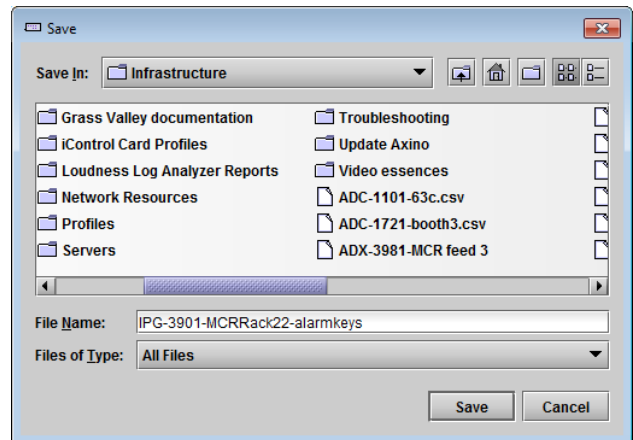

Figure 5-22 Get Alarm Keys dialog

OK, Apply, Cancel

- **OK** accepts the settings and closes the window once the card confirms that there are no errors.
- **Apply** accepts the settings, but leaves the window open
- **Cancel** closes the window without applying any changes, and leaves the previous settings intact.

5.10 Info Panel

5.10.1 Info Panel – Info tab

When the IPG-3901 is included in an iControl environment, certain information about the card should be available to the iControl system. The user can enter labels and comments that will make this card easy to identify in a complex setup. This information is entered into data boxes in the Info control panel.

Label: Type the label that is shown for this IPG-3901 when it appears in iControl applications

Short Label Type the short-form label that iControl uses in some cases (8 characters)

Source ID Type a descriptive name for this IPG-3901

Comments: Type any desired text

The remaining data boxes show manufacturing information about this card.

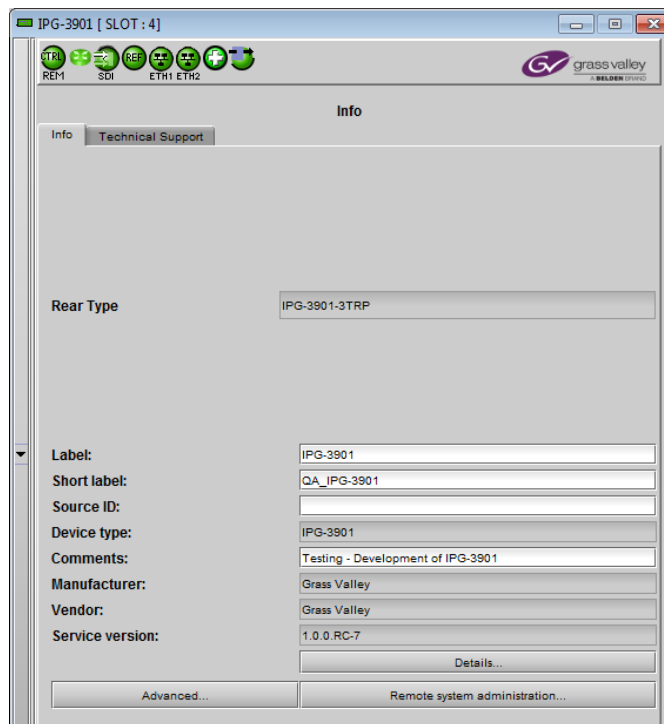

Figure 5-23 Info Panel

Three buttons in the panel give access to other information.

- **Details...:** Reports the Firmware version, service version, and panel version for this card

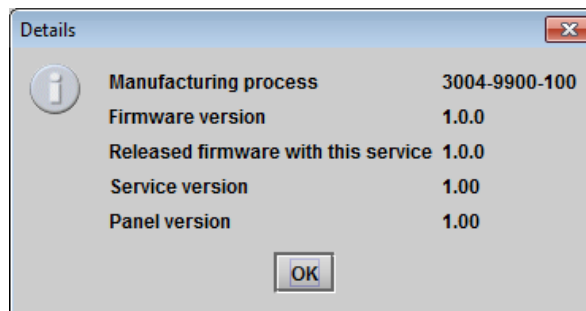

Figure 5-24 Details window

- **Advanced...:** Shows the Long ID for this card. The Long ID is the address of this IPG-3901 in the iControl network.

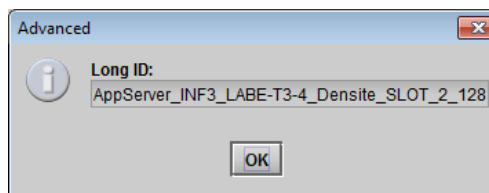

Figure 5-25 Advanced window

- Remote System Administration – opens the *Joining Locators* window, which lists remote lookup services to which this IPG-3901 is registered

Add: Force the iControl service for this IPG-3901 to register itself on a user-specified Jini lookup service, using the following syntax in the data box:

jini://<ip_address>

where <ip_address> is the ip address of the server running the lookup service, e.g.:

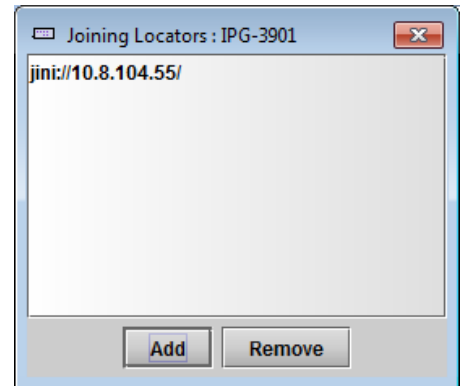
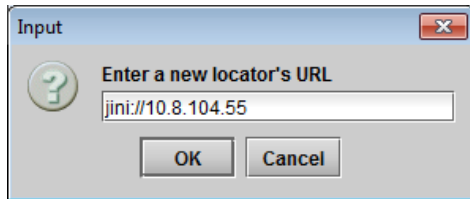
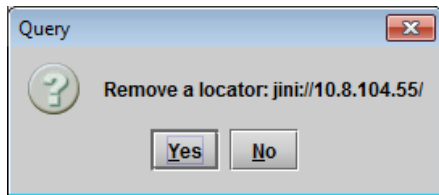

Figure 5-26 Joining Locators window

Remove: select one of the services listed in the window by clicking on it, and click *Remove* to open a query box allowing you to delete it from the window.



5.10.2 Info Panel – Technical Support tab

If technical support from Grass Valley is required for your IPG-3901, you may be requested to provide a system snapshot that will help Tech Support to troubleshoot your card.

1. Click the *Get System Snapshot* button.
2. In the Warning window that appears, click *Yes* to proceed with the snapshot, or *No* to decline.
3. If you clicked *Yes*, a system snapshot will be generated and saved on-board the card.
4. Tech Support will advise on what to do next.

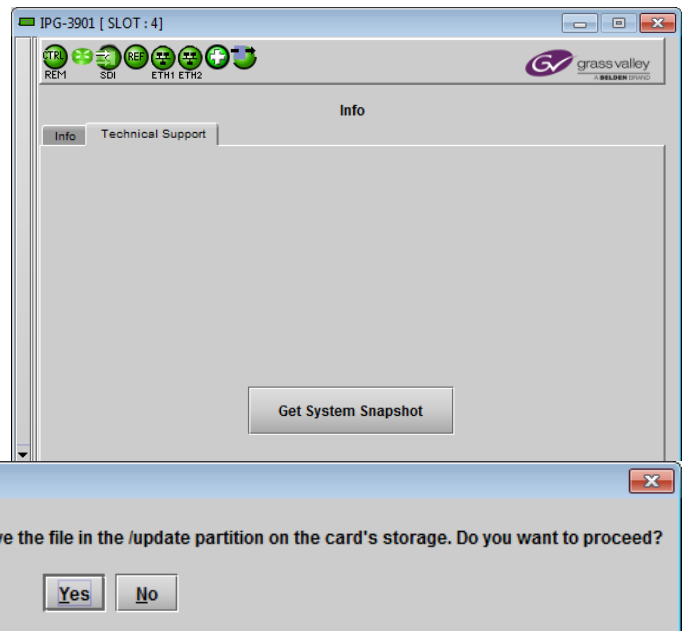

Figure 5-27 Info Panel - Technical Support tab

6 Specifications

SDI (Inputs/Outputs)

Physical:	11 BNC connectors: 2 IN, 2 OUT, 7 independently configurable as input or output
SDI Standard:	SMPTE-259M-C (270 Mb/s) SMPTE-292M (1.485, 1.485/1.001 Gb/s) SMPTE-424M (2.970, 2.970/1.001Gb/s)*
Supported formats:	SD: 480i59.94, 576i50 HD: SMPTE-274M: 1080i59.94, 1080i50 HD: SMPTE-296M: 720p59.94, 720p50 3G: SMPTE-425M level A (mapping 1), level B*: 1080p59.94, 1080p50 4K UHD: Quad link 3 Gb/s SMPTE ST 425-5 (3G-SDI Link 1, Link 2, Link 3 and Link 4): 1080p59.94, 1080p50
Cable length (Belden 1694A):	SD: 300m (984 ft.) at 270 Mb/s HD: 150m (492 ft.) at 1.5 Gb/s 3G: 100m (393 ft.) at 2.970 Gb/s
Return loss:	>15 dB up to 1.5 GHz >10 dB up to 3 GHz
Jitter:	HD/SD: <0.2 UI (alignment jitter) 3G: <0.3 UI (alignment jitter)

Reference Input

Black burst 525 (SMPTE 170M and SMPTE 318M)
Black burst 625 (ITU 624-4).

Ethernet Port

Physical:	Two SFP+ sockets for copper, short reach and long reach fiber
Standard:	IEEE 802.3-2008 10 GigE
Transport:	SMPTE 2022-6 IP Unicast or Multicast with IGMPv3
Performance:	Up to 9 Gb of streaming per direction

4K UHD Video Compression

Codec:	intoPIX TICO profile 1
Quality:	4:1 visually lossless
Additional latency:	Encoder: 4.5 lines Decoder: 2.5 lines 2SI/SDQS conversion: 1 frame

Electrical

Power:	37.5W maximum
--------	---------------

* 3G level A signaling currently supported. 3G level B signaling will be supported at a later date with a firmware update

7 Contact Us

Grass Valley Technical Support

For technical assistance, contact our international support center, at 1-800-547-8949 (US and Canada) or +1 530 478 4148.

To obtain a local phone number for the support center nearest you, please consult the *Contact Us* section of Grass Valley's website (www.grassvalley.com).

An online form for e-mail contact is also available from the website.

Corporate Head Office

Grass Valley
3499 Douglas-B.-Floreani
St-Laurent, Quebec H4S 2C6
Canada

Telephone: +1 514 333 1772

Fax: +1 514 333 9828

www.grassvalley.com

ANNEX 1 – Local Menu

1st level	2nd level	3rd level	4th level	Comments / Default Value
STATUS	GENERAL	REAR TYPE	IPG-3901-3+DRP IPG-3901-3TRP	
		SERIAL NUMBER	XXXXXX-XXXXXXXX	
	REFERENCE	MISSING		
		REF NTSC		
		REF PAL		
		REF URS 29		
		REF URS 25		
	NO REF			
	REF-MISMATCH			
	UNSUPPORTED			
	NOT LOCKED			
	PTP	ETH1		
		ETH2		
		MISSING		
ETH1	LINK STATUS	LINK UP LINK DOWN		
	MAC ADDRESS	00:00:00:00:00:00		
ETH2	LINK STATUS	LINK UP LINK DOWN		
	MAC ADDRESS	00:00:00:00:00:00		
GATEWAY	[n]	ACTIVE INACTIVE DISABLED	Gives the global status for the gateway [n]. Where [n] is: SDI IN 1, SDI IN 2, SDI IN/OUT 1 to 7, SDI OUT 1 and SDI OUT 2.	
		<video format>	Reports the video format of the gateway.	
HEALTH	HARDWARE	HARDWARE OK HARDWARE FAILURE		
	FAN	FAN OK FAN FAILURE		

		TEMPERATURE	TEMPERATURE OK TEMPERATURE FAILURE		
CARD PRESET	LOAD	<name>		Loads the user preset selected. <name> is the preset name	
	SAVE	<name>		Save the user preset in the preset selected.	
NETWORK CONFIG	ETH1	IP ADDRESS	0.0.0.0	192.168.3.31	
		MASK	255.255.255.0	255.255.255.0	
		GATEWAY	0.0.0.0	0.0.0.0	
	ETH2	IP ADDRESS	0.0.0.0	192.168.2.32	
		MASK	255.255.255.0	255.255.255.0	
		GATEWAY	0.0.0.0	0.0.0.0	
REFERENCE	SCAN RATE	50 / 25Hz 59.94 / 29.97Hz		59.94 Hz	
	SOURCE	AUTO EXTERNAL URS NO REF		AUTO	
	URS	OFF ON		ON	
	PTP	DOMAIN	0 to 127		127
		INTERVAL	0.125s, 0.25s, 0.5s, 1s, 2s		0.125s
For AES-67 profiles: 4s, 8s, 16s					
RECEIPT TIMEOUT	2 to 10		3		
TEST PATTERN	FORMAT	1080p 1080i		1080i	

GUIDE TO INSTALLATION AND OPERATION

		720p SD		
	FORCE ALL	ON OFF		OFF
	[n]	ON OFF		OFF Where [n] is: SDI IN 1, SDI IN 2, SDI IN/OUT 1 to 7, SDI OUT 1, SDI OUT 2.
VERSION	vx.x.x bld xxxx			e.g.: v1.1.0 bld 134
	FPGA BUILD: xxx			Version of the FPGA
FACTORY DEFAULT	WITHOUT NETWORK	APPLY		If selected, everything but network configuration is restored to factory
	INCLUDE NETWORK	APPLY		If selected, everything is factory defaulted.

ANNEX 2 – Firmware upgrade

The method for upgrading the IPG-3901 firmware depends on the controller version in use in the frame in which the card is installed:

Frame & Controller	Upgrade strategy
<ul style="list-style-type: none"> Densité 3 with CPU-ETH2 controller. Densité 3+ FR4 with CPU-ETH3 base Controller. 	Upgrade the firmware through the media port (ETH1) using the procedure described in this Annex, and upgrade the iControl service using the Densité Upgrade Manager (DUM).
<ul style="list-style-type: none"> Densité 3+FR4 with CPU-ETH3 advanced controller. GV Node. 	Upgrade both firmware and IControl service using the Densité Upgrade Manager (DUM).
Please consult the iControl User's Guide for information about the iControl Densité Upgrade Manager.	

Upgrade using the media port ETH1

The IPG-3901 firmware can be updated through the media port ETH1 using the Densité Upgrade Manager (DUM) in iControl Solo. Unfortunately, we need an additional installation setup to proceed with the upgrade. The firmware package transfer is done using an ftp connection from PC to the IPG-3901 through the media Network Switch.

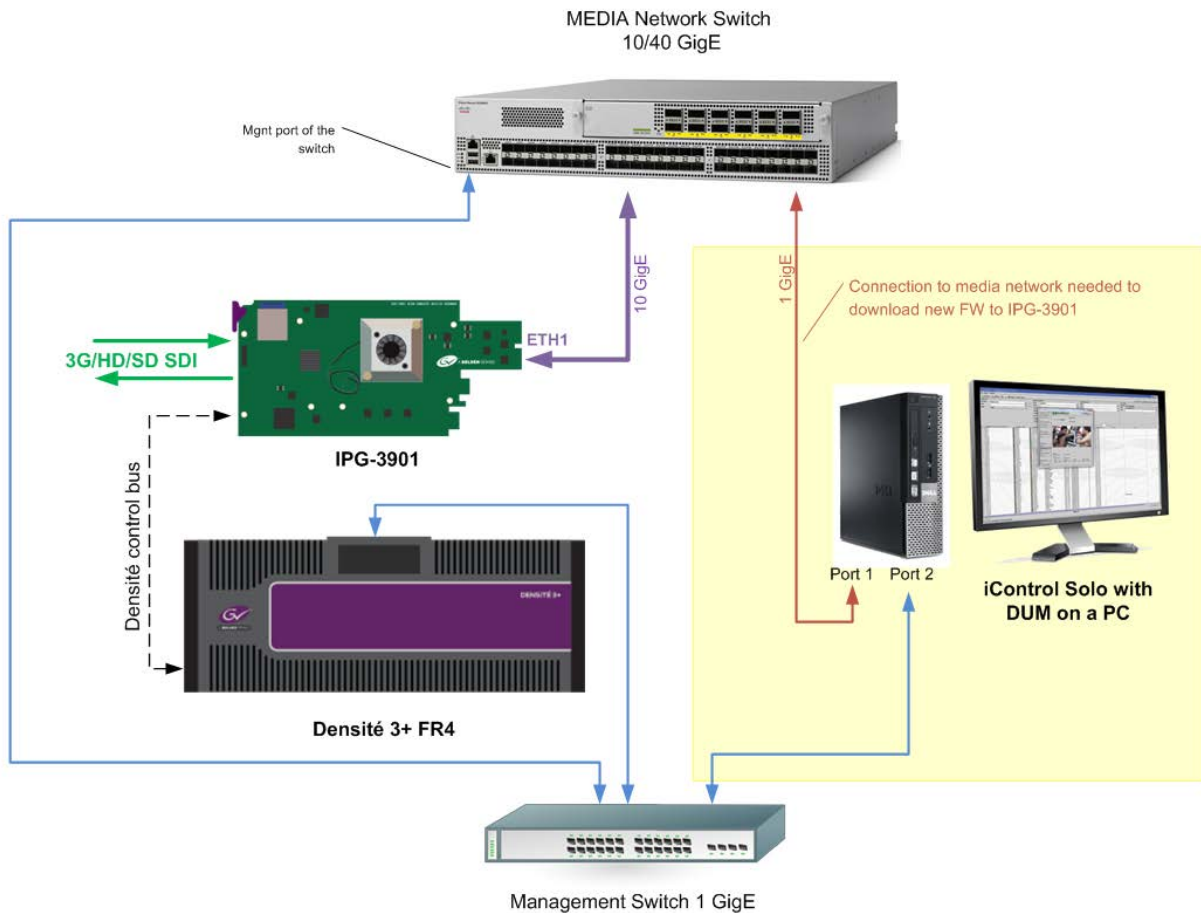

For the upgrade, you need to connect a PC to the MEDIA Network Switch and use iControl Solo (Yellow zone). When you are done with the upgrade, the PC connection to the switch is no longer required

GUIDE TO INSTALLATION AND OPERATION

If you don't have the proper installation to upgrade the firmware as described above, you can update the firmware by manually installing the upgrade file onto the IPG-3901's SD card.

- You will need an SD card reader connected to your PC.

Proceed as follows:

1. Remove the IPG-3901 from its Densité frame.
2. Remove the SD card from the IPG-3901 board and place it in the SD card reader.
3. On your PC, unzip the iControl upgrade package.
4. Copy the "firmware-x.x.x.xx.zip" file from the "card" folder in the upgrade package and drop it onto the SD card.
5. Locate the firmware file from Step 4 in the Update partition of the SD card, and rename it "ipg3901-upgrade-vx.x.x.x.zip".
e.g. "firmware-1.3.2.23.zip" should be changed to "ipg3901-upgrade-v1.3.2.32.zip"
6. Remove the SD card from the card reader, and re-install it on the IPG-3901 card.
7. Insert the IPG-3901 back into its slot in the Densité frame.
8. The card will automatically install the new firmware and re-boot.

If you using an appserver with iControl to control and monitor the IPG-3901 card, you will be required to install the new iControl service package on the appserver, once again using the (DUM).

Verify that the card has been updated with the correct firmware as described above, and select the "Upgrade" option on (DUM), that will upgrade the iControl service only.

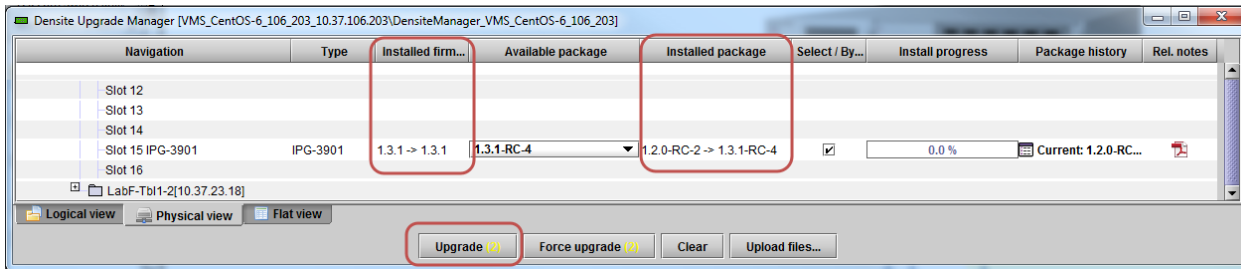

ANNEX 3 – Block Diagrams of TICO Models

