



MAP-3901

3G/HD/SD Metadata & Embedded Audio Processor

Guide to Installation and Operation

M3022-9900-100

2015-07-27

www.grassvalley.com

Electromagnetic Compatibility



This equipment has been tested for verification of compliance with FCC Part 15, Subpart B requirements for Class A digital devices.

NOTE: This equipment has been tested and found to comply with the limits for a Class A digital device, pursuant to part 15 of the FCC Rules. These limits are designed to provide reasonable protection against harmful interference when the equipment is operated in a commercial environment. This equipment generates, uses, and can radiate radio frequency energy and, if not installed and used in accordance with the instruction manual, may cause harmful interference to radio communications. Operation of this equipment in a residential area is likely to cause harmful interference in which case the user will be required to correct the interference at his own expense.



This equipment has been tested and found to comply with the requirements of the EMC directive 2004/108/CE:

- EN 55022 Class A radiated and conducted emissions
- ENV 50204 Radiated EMF Immunity – RF 900 MHz Pulsed
- EN 61000-3-2 Harmonic current emission limits
- EN 61000-3-3 Voltage fluctuations and flicker limitations
- EN 61000-4-2 Electrostatic discharge immunity
- EN 61000-4-3 Radiated electromagnetic field immunity – radio frequencies
- EN 61000-4-4 Electrical fast transient immunity
- EN 61000-4-5 Surge transient immunity
- EN 61000-4-11 Voltage-dips, short-interruption and voltage variation immunity

Table of Contents

1	MAP-3901 3G/HD/SD Metadata and Embedded Audio Processor	1
1.1	Introduction	1
1.2	Features	1
1.3	Functional Block Diagram	2
1.4	Front Card-edge Interface.....	3
2	Installation.....	4
2.1	Installation of Rear Connector Panels	4
2.2	MAP-3901 Card Installation	5
2.3	Rear Panels and Connectors.....	5
2.3.1	Images of Rear Panel Connectors.....	5
2.3.2	Summary of rear panel connections	6
2.3.3	Details of rear panel connections	6
3	User Interface.....	8
3.1	Control options.....	8
3.2	Card-Edge Status LED	8
4	Local control using the Densité frame control panel	9
4.1	Overview	9
4.2	Menu for local control.....	9
5	Remote control using iControl.....	10
5.1	The iControl graphic interface window.....	10
5.2	Video Input/Output panel	13
5.2.1	Video Input / Output panel – Input tab	13
5.2.2	Video Input / Output Panel – Timing tab.....	14
5.4	Reference Panel	16
5.5	Card processing delay	17
5.6	Audio Functional Block diagram	17
5.7	Embedded Audio Panel	17
5.7.1	Embed Ch X-Y tabs	19
5.8	Decoders Panel.....	22
5.8.1	Dolby E Decoder n tab.....	22
5.8.2	Audio Processing	24
5.9	Upmix Panel.....	26
5.9.1	Upmix n tab.....	26
5.9.3	Audio Processing	30
5.10	Downmix Panel	32
5.10.1	Downmix n tab	32
5.10.2	Audio Processing	36
5.11	Encoders Panel.....	39
5.11.1	Encoder Dolby Digital n tab	39
5.12	Audio Outputs Panel	42
5.12.1	CH n-m tab.....	43
5.12.2	Embedded Audio Config tab	44
5.13	Audio Metadata Panel.....	45

GUIDE TO INSTALLATION AND OPERATION

- 5.13.1 Path n tab45
- 5.13.2 Path n – Probe n tab.....46
- 5.13.3 Path n – Generator n tab46
- 5.13.4 Path n – Presets tab48
- 5.13.5 Input/Output tab49
- 5.14 Test Panel.....50
- 5.15 GPIO Panel51
 - 5.15.1 I/O Config tab51
 - 5.15.2 GPI Config tab52
 - 5.15.3 GPO Config tab53
- 5.16 Options Panel54
- 5.17 Alarm Config Panel.....55
- 5.18 Info Panel.....57
- 5.19 Factory/Presets Panel59
 - 5.19.1 Card Presets.....59
 - 5.19.2 Factory.....60
 - 5.19.3 Profiles.....60
- 6 Specifications 64**
- 7 Contact Us..... 67**
 - Grass Valley Technical Support67
 - Corporate Head Office.....67

1 MAP-3901 3G/HD/SD Metadata and Embedded Audio Processor

1.1 Introduction

The Densité MAP-3901 from Grass Valley, a Belden Brand, is the latest generation metadata and audio processor in the Densité family, offering sophisticated audio signal processing on a single 3RU module. The powerful and versatile processing platform delivers significant value to users by simultaneously processing up to 56 channels of audio (16 channels of embedded audio from the video plus others generated internally). Functions include dual down-mixing, level control, channel shuffling/mixing and an on-board DSP engine that can run simultaneously as optional licenses up to two Dolby-E decoders, four Dolby Digital & Digital Plus encoders, and two Upmixers (2.0 to 5.1).

The card will pass and automatically delay all 56 internal audio channels to preserve lip sync between the channels. Each channel can be delayed independently to correct any lip sync issues. All audio channels can be mixed and shuffled to provide 16 channels for embedding in the video output.

The card can be genlocked to an external reference or to the frame reference using the internal URS signal.

The card has a frame buffer (not a frame sync) which allows an increase in the video delay of up to 4.1 seconds in HD to compensate for the long audio processing delay required by some audio processing functions or for effective processing of incoming feeds especially where there is a mix of short and long delay feeds, often the case when managing large live events.

Four audio metadata insertions in the VANC are possible from multiple sources, such as Dolby E decoders, embedded VANC streams or from the integrated metadata generators. All parameters in the metadata streams can be probed and monitored. Audio metadata (method A or B) can be used to steer the behavior of the audio down-mixers and the Dolby encoders.

The MAP-3901 has eight GPIO that can be used as input or output, which can be used to load the cards user presets.

The rear modules for the MAP-3901 have a bypass relay that connects the main input directly to the output if the card fails, loses power or if the card is removed.

Up to 10 MAP-3901 processors can be housed in the Densité 3 (3RU) frame, and up to 4 MAP-3901 processors can be housed in the Densité 3+ FR1 (1RU) for even greater space-efficiency.

To broadcasters, the MAP-3901 means that new generation of audio processing requirements can be achieved on a single module, while minimizing a facility's environmental footprint and improving scalability, flexibility and reliability.

Note – The current release of the MAP-3901 supports a single electrical input with dual outputs. Fiber connectivity will be added in a subsequent release.

1.2 Features

Video

- 3G/HD/SD input
- Supports 3Gb/s level A (mapping 1) and level B Dual link
- Flexible SD/URS reference input
- Programmable audio/video delay of up to 4.1 seconds (124 frames) in HD
- Bypass relay with MAP-3901-3DRP-R, MAP-3901-3DRP-F-R and MAP-3901-3+SRP-R- rear modules.
- Optional optical fiber I/O¹ module with MAP-3901-3DRP-R-F rear module (*future*)

¹SFP Plug-in Cartridges will be supported at a later date with a firmware update.

Metadata

- 4 Audio Metadata insertion and extraction (SMPTE 2020 Method A or B)

Audio

- Full audio shuffling and mixing per channel basis
- 56 channels internal audio processing
- Audio 5.1 surround downmix to Lt/Rt or Lo/Ro
- Audio delay adjustments of up to 2 seconds to compensate for lip sync
- Up to 2 optional Dolby E decoders
- Up to 2 optional stereo to 5.1 upmixers
- Up to 4 optional Dolby Digital and Digital Plus Encoders.

1.3 Functional Block Diagram

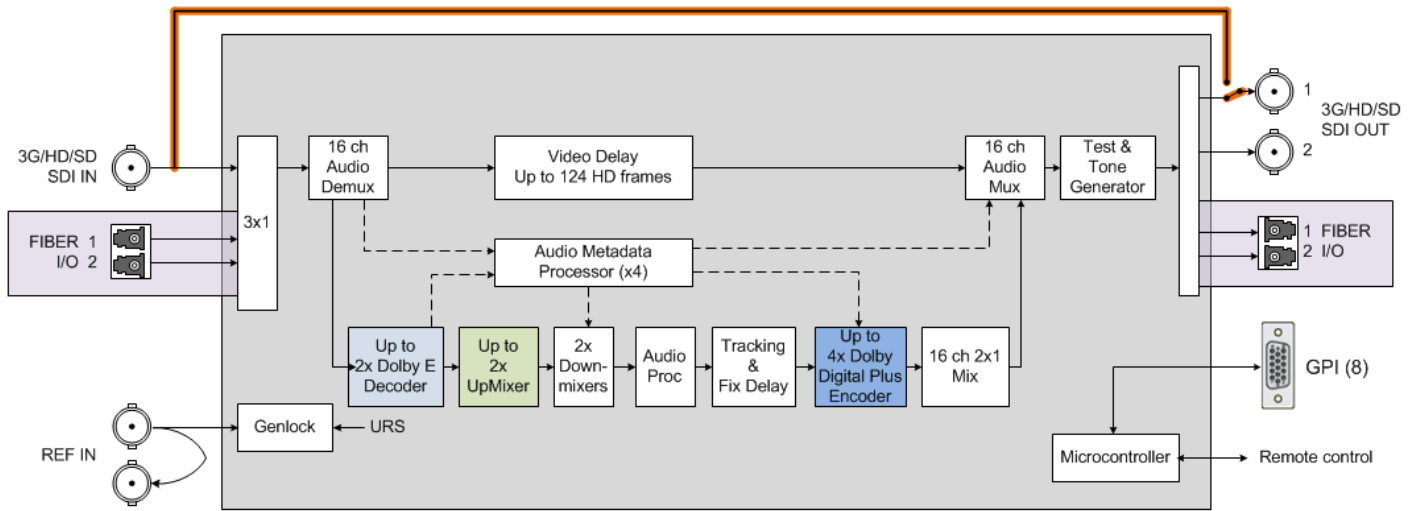

MAP-3901 Functional Bloc Diagram





Options (hardware and software)			
	With -R Rear Modules		MAP-3901-OPT-DED
	With appropriate SFP cartridge and -F rear Modules		MAP-3901-OPT-UPMIX
			MAP-3901-OPT-DDE

Figure 1-1 MAP-3901 Functional Block Diagram

1.4 Front Card-edge Interface

The front card-edge of the MAP-3901 incorporates two elements:

- [Status LED](#) (see section 3.2)
- [Select Button](#) (see section 4)

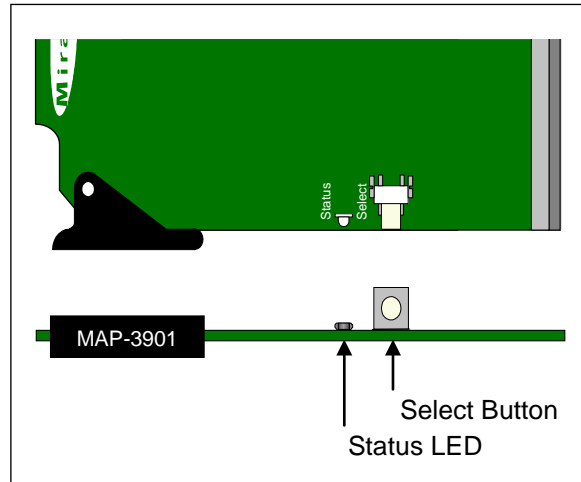

Figure 1-2 Front card-edge layout

2 Installation

2.1 Installation of Rear Connector Panels

Grass Valley Densité-series cards are each associated with a rear connector panel, which must be installed in the Densité frame before the card can be inserted.

The MAP-3901 card is designed to fit into Grass Valley's Densité-3 frame. Two different rear connector panels are available for this configuration. Due to connector space requirements, a double-slot-width rear panel is necessary:

- MAP-3901-3DRP-R Double-slot-width panel for Densité-3 with bypass relay
- MAP-3901-3DRP-F-R Double-slot-width panel for Densité-3 with fiber I/O and bypass relay

A single-slot-width rear panel is available for use in the Densité -3+FR1 compact frame. This panel uses DIN video connectors to fit the required I/O into the available space:

- MAP-3901-3+SRP-R-D Single-slot-width panel for Densité-3+ with bypass relay and DIN connectors.

See [section 2.3](#) for details of the signal connections available on each of these panel types.

All cards and rear panels can be installed with the frame power on. The card has connectors which plug into a mid-frame mother board for distribution of power and for connection to the controller card, and a second connector which plugs directly into the rear connector panel for input and output.



The rear connector panel must be installed with the card out of the frame.

- To remove an existing card from the slot, tilt up the swivel handle on the front of the card to lever the connectors apart, then use the handle to pull the card straight out of the slot.

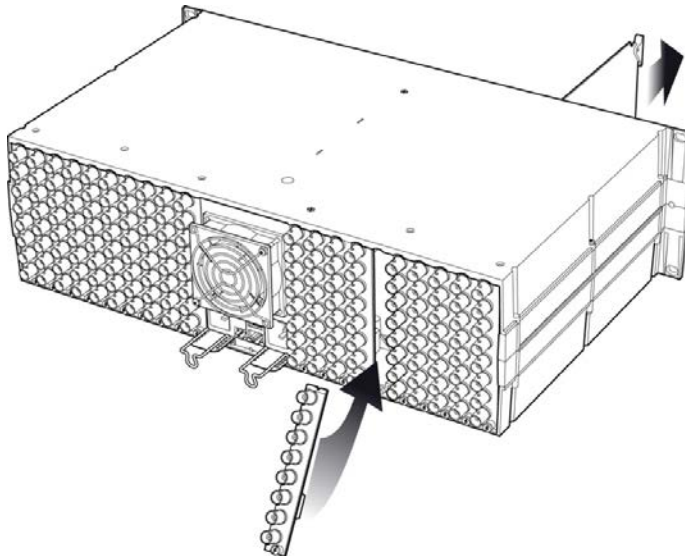

Figure 2-1 Densité-3 frame – rear panel installation

To install the connector panel:

Note – the procedure is the same for both Densité-2 and Densité-3 frames.

1. If a card is installed in the slot whose rear panel is being changed, remove it as described above.
2. Remove the existing panel (either blank or belonging to an existing card that is being changed) by releasing the captive screw(s) at the bottom.
3. Position the new panel and secure it in place with the captive screw(s) at the bottom.

2.2 MAP-3901 Card Installation

Once a matching rear connector panel is in place, install the MAP-3901 card as follows:

1. Open the front panel of the frame.
2. Slide the MAP-3901 card into the slot and push gently on the handle to seat the connectors.

When using a double-slot-width rear panel in a Densité-3 frame, the card should be inserted into the right-most of the two slots. Inserting the card into the wrong slot will not damage the card, and will be flagged by the on-card status LED flashing red to indicate that there is no connection to the rear panel.

3. Close the front panel of the frame.

2.3 Rear Panels and Connectors

2.3.1 Images of Rear Panel Connectors

The three available rear panels are shown in the figure. Details of the inputs and outputs are described below.

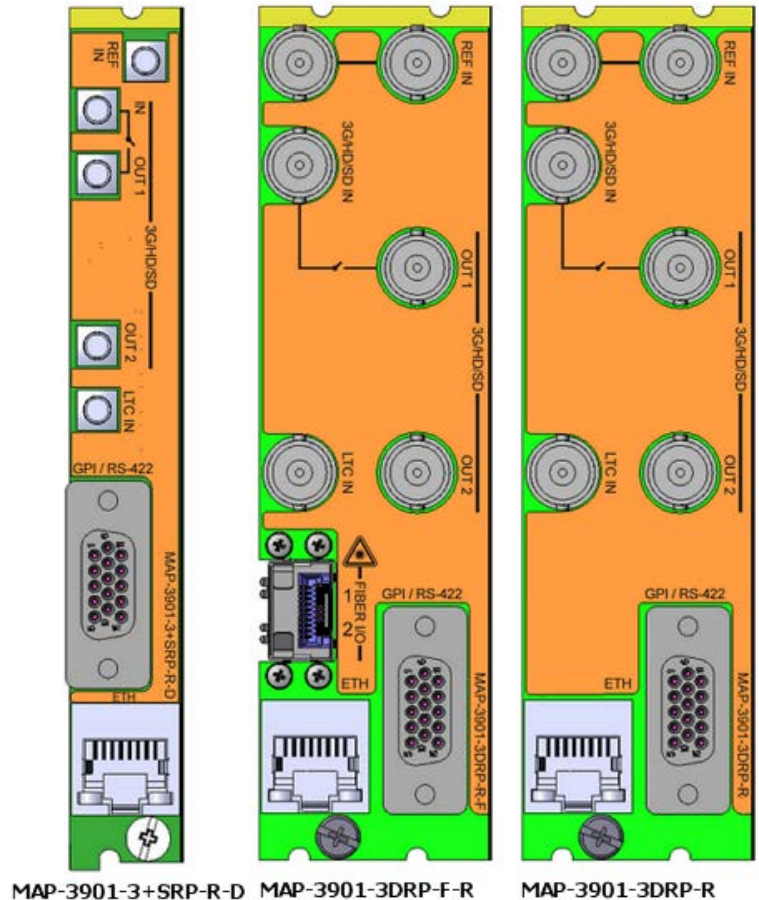

Figure 2-2 MAP-3901 Rear Panels

2.3.2 Summary of rear panel connections

<i>MAP-3901-3DRP-F-R (future)</i>				
MAP-3901-3DRP-R				
MAP-3901-3+SRP-R-D				
<i>MAP-3901-3+SRP-F-D (future)</i>				
Single-slot-width panel for Densité 3+FR1 frame	◆	◆	◆	◆
Double-slot-width panel for Densité 3 frame			◆	◆
CONNECTORS				
Reference (+loop) *	1	1	1+1	1+1
3G/HD/SD IN *	1	1	1	1
3G/HD/SD OUT *	2	2	2	2
LTC *	1	1	1	1
GPI – I/O (8) and RS-422 on D-SUB	8	8	8	8
Ethernet on RJ45	yes	yes	yes	yes
Fiber I/O module	yes			yes
Bypass relay (IN to OUT 1)		yes	yes	yes

* DIN1.0/2.3 connectors on MAP-3901-3+SRP-R-D panel; BNC connectors on all other panels.

2.3.3 Details of rear panel connections

3G/HD/SD IN – Serial digital 3G/HD/SD input

Connect a serial digital video signal, conforming to the SMPTE 425M standard for 3G input signals, SMPTE 292M standard for HD input signals or SMPTE 259M standard for SD input signals, to the connector labeled **3G/HD/SD IN**.

3G/HD/SD OUT – Serial digital video outputs

The MAP-3901 provides two 3G/HD/SD SDI video outputs on the connectors labeled **3G/HD/SD OUT 1 and 2**. The SDI video signal conforms to the input standard. The same signal is carried on both outputs.

REF IN – External reference

Connect an NTSC or PAL reference signal (SMPTE 170M/SMPTE 318M/ITU 624-4 black burst)

LTC IN

Connect a time code source (will be added in a subsequent release).

GPIO / RS-422

The eight configurable GPIO are interfaced via a 15-pin D-SUB connector. Pinout for the connector is shown in the table.

Functionality:

GPI: Contact closure to ground (opto-isolated), common ground

GPO: SIGNAL Opto-isolated, common ground
 VOLTAGE -5V to 24V max.
 CURRENT (V/R) 60mA max.

RS422 – (future use)

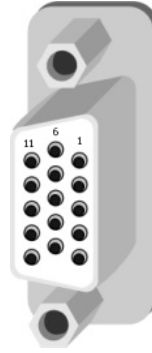

Signal	DE15 Pin #
GPIO-1	12
GPIO-2	8
GPIO-3	11
GPIO-4	6
GPIO-5	5
GPIO-6	4
GPIO-7	2
GPIO-8	1
GND	9, 18 to 26

3 User Interface

3.1 Control options

The MAP-3901 can be controlled in two different ways:

- The local control panel and its push-buttons can be used to move through a menu of status reports (see [section 4](#)).
- Miranda’s iControl system can be used to access the card’s operating parameters from a remote computer, using a convenient graphical user interface (GUI) (see [section 5](#)).

3.2 Card-Edge Status LED

The status monitor LED is located on the front card-edge of the MAP-3901, and is visible through the front access door of the DENSITÉ frame. This multi-color LED indicates the status of the MAP-3901 by color, and by flashing/steady illumination.

The chart shows how the various error conditions that can be flagged on the MAP-3901 affect the LED status.

- If a cell is gray, the error condition cannot cause the LED to assume that status
- If more than one LED status is possible for a particular error condition, the status is configurable. See [Alarm Config Panel](#) for details.
- The factory default status, if available, is shown by a ⚙

The LED will always show the most severe detected error status that it is configured to display, and in the chart error severity increases from left to right, with green representing no error/disabled, and flashing red the most severe error.

If the LED is Flashing Yellow, it means that the card is selected for local control using the Densité frame’s control panel. See [section 4](#) for details.

Error Condition	LED Status			
	Green	Yellow	Red	Flashing Red
Hardware failure – cooling fans				⚙
Missing Rear				⚙
Relay bypass ON			⚙	
Selected reference presence missing			⚙	
Reference mismatch			⚙	
BNC IN video error			⚙	
Audio silence EMBED CH1 : : Audio silence EMBED CH16	⚙			
Test pattern		⚙		
Lip-sync problem			⚙	

4 Local control using the Densité frame control panel

4.1 Overview

Push the SELECT button on the MAP-3901 card edge (see section 1.4) to assign the local control panel to operate the MAP-3901. Use the control panel buttons to navigate through the menu, as described below.

All of the cards installed in a Densité frame are connected to the frame's controller card, which handles all interaction between the cards and the outside world. There are no operating buttons located on the cards themselves. The controller supports remote operation via its Ethernet ports, and local operation using its integrated control panel.

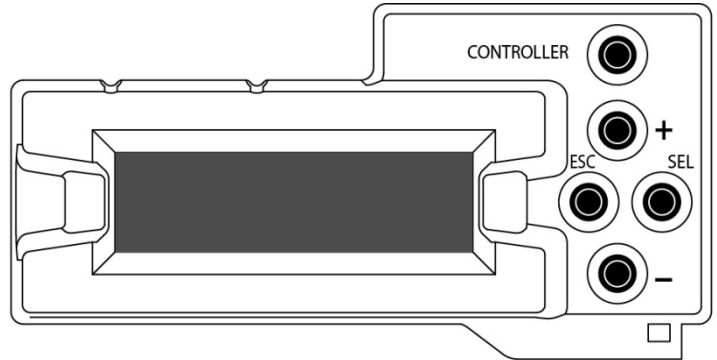

Figure 4-1 Densité Frame local control panel

The local control panel is fastened to the front of the CPU-ETH2 controller card, and when installed is located in the front center of the frame, positioned in front of the power supplies. The panel consists of a display unit capable of displaying two lines of text, each 16 characters in length, and five pushbuttons.

The panel is assigned to operate any card in the frame by pushing the SELECT button on the front edge of that card.

- Pushing the CONTROLLER button on the control panel selects the Controller card itself.
- The STATUS LED on the selected card flashes yellow.

The local control panel displays a menu that can be navigated using the four pushbuttons located beside the display. The functionality of the pushbuttons is as follows:

[+] [-] Used for menu navigation and value modification

[SELECT] Gives access to the next menu level. When a parameter value is shown, pushing this button once enables modification of the value using the [+] and [-] buttons; a second push confirms the new value

[ESC] Cancels the effect of parameter value changes that have not been confirmed; pushing [ESC] causes the parameter to revert to its former value.

Pushing [ESC] moves the user back up to the previous menu level. At the main menu, [ESC] does *not* exit the menu system. To exit, re-push the [SELECT] button for the card being controlled.

If no controls are operated for 30 seconds, the controller reverts to its normal standby status, and the selected card's STATUS LED reverts to its normal operating mode.

4.2 Menu for local control

The MAP-3901 has a limited number of status reports that may be accessed locally at the controller card interface.

- Press the SELECT button on the MAP-3901 front card edge to assign the Densité frame's local control panel to the MAP-3901
- Use the keys on the local control panel to step through the displayed menu to check the available status information.

5 Remote control using iControl

The operation of the MAP-3901 may be controlled using Miranda's iControl system.

- This manual describes the control panels associated with the MAP-3901 and their use.
- Please consult the iControl User's Guide for information about setting up and operating iControl.

In iControl Navigator or iControl Websites, double-click on the MAP-3901 icon to open the control panel.

5.1 The iControl graphic interface window

The basic window structure for the MAP-3901 is shown in figure 5.1. The window identification line gives the card type (MAP-3901) and the slot number where the card is installed in its Densité frame.

There are four main sections in the window itself, as identified in the figure:



Figure 5-1 MAP-3901 iControl graphic interface window

Section 1. The top section displays six icons on the left. These icons report different statuses such as card communication status, input signal format, reference signal format, health status, card operation mode and Video Buffer status. In some instances, they relate to conditions defined through parameters settings.



Icon # 1 2 3 4 5 6







Move the mouse over an icon and a status message appears below the icon providing additional information. If there is an error, the error status message appears in the message area without mouse-over.







- If there are multiple errors, the error messages cycle so all can be seen
- The icon whose status or error message is shown is highlighted with a mauve background

The table below describes the various status icons that can appear, and how they are to be interpreted.

- In cases where there is more than one possible interpretation, read the error message in the iControl window to see which applies.

Table –iControl Status Icon interpretation

Icon #1 – Manual Card Configuration	
 <p>CTRL REM (green)</p>	Remote card control activated. The iControl interface can be used to operate the card
 <p>CTRL LOCAL (yellow)</p>	Local card control active, The card is being controlled using the Densité frame control panel, as described in section 4 . Any changes made using the iControl interface will have no effect on the card.
Icon #2 – Input status	
 <p>(green)</p>	Signal detected and valid. Beneath the icon, the format will be indicated as 3G, HD or SD, and the specific format details will be listed if the cursor is moved over the icon.
 <p>(red)</p>	No rear Video not valid Reference mismatch Bypass relay ON
Icon #3 – Selected Reference	
 <p>REF (green)</p>	Reference OK and video output is locked. Mouse over to see the source of the reference, and its format, e.g. External, NTSC
 <p>REF (red)</p>	Reference not present or not valid Reference format not supported Video not locked

Icon #4 – Health Monitoring	
 (green)	Hardware OK
 (red)	Hardware Health Monitoring (Hardware fault detected) If this icon appears flashing red, you need to change the FPGA FAN and/or DSP FAN
Icon #5 – Operation Mode	
 (green)	Operation mode: process – normal processing of the input signal
 (yellow)	Operation mode: Card bypass – rear panel bypass relay is activated in the Video Input/Output panel
 (yellow)	Operation mode: TEST – color bar and audio test tones enabled (see section 5.14)
Icon #6 – System (Video Buffer Status)	
 (green)	Buffer OK for current operational set-up.
 (red)	Not enough video buffer – must add additional frame delay (amount will be shown) (may occur when using decoders, upmixers, downmixers and/or encoders, and audio metadata insertion)

Section 2. The left portion of the window contains all the parameter groups, which become highlighted when they are selected; the main panel (4) then displays the group's set of parameters. Each of the groups is described in detail below.

Section 3. The lower left corner of the window identifies the Preset currently in use or “Custom” if none is applicable.



Section 4. The main panel contains all the parameters specific to the group selected. It may contain several tabs to help manage the different parameters.

Each of the panels associated with the groups accessed from the buttons in Section 2, and shown in Section 4, is described individually in the following sections.

5.2 Video Input/Output panel

5.2.1 Video Input / Output panel – Input tab

Input Status – the icon shows the signal validity and the data box shows the input format.

Icon	Carrier	Format
	Red	None or not valid
	Yellow	Present & Valid
	Green	Present & Valid

Supported Video Formats		
720x484i 59Hz	1280x720p 59.94Hz	1920x1080i 59.94Hz 1920x1080p 59.94Hz A 1920x1080p 59.94Hz B DL
720x576i 50Hz	1280x720p 50Hz	1920x1080i 50Hz 1920x1080p 50Hz A 1920x1080p 50Hz B DL

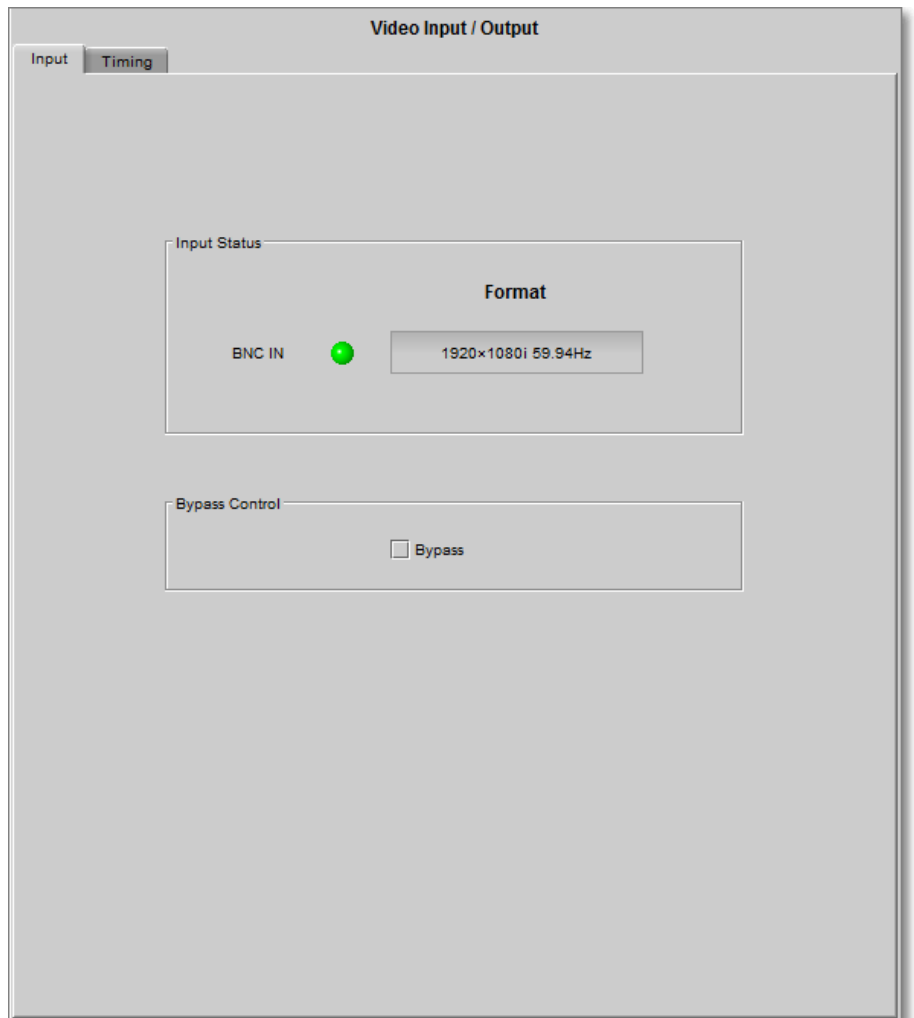

Figure 5-2 Video Input/Output - Input tab

Bypass Control – select the *Bypass* checkbox to route the electrical input directly to electrical output 1 on the rear panel, bypassing the card

- A card in bypass mode can be removed from the frame without interrupting the signal flow.
- Bypass control is not saved after a power up. This control is here for testing purpose
- The signal presence and validity icons in the iControl panels will turn RED when bypass is activated, because the input signal is bypassing card

5.2.2 Video Input / Output Panel – Timing tab

The Timing tab provides access to timing adjustments which affect the signal outputs. There are three slider controls, each with a data reporting box which shows the current value, and into which values can be typed directly.

Vertical (lines): With this adjustment, a value ranging from -16 to +16 lines compared to the reference or the processing delay, may be set. This adjustment can be used in conjunction with the horizontal timing adjustment.

Vertical values	Default
-16 to 16 lines	0 line

Horizontal (µs): With this adjustment, a value ranging from zero to the equivalent of 1 horizontal line can be set in the current output format compared to the reference or the frame boundary may be set.

Video Formats	Horizontal values	Default	Video Formats	Horizontal values	Default
720x484i 59Hz	0 to 63.52 µsec	0 µs	720x576i 50Hz	0 to 63.96 µsec	0 µs
1920x1080i 59Hz	0 to 29.646 µsec	0 µs	1920x1080i 50Hz	0 to 35.542 µsec	0 µs
1280x720p 59Hz	0 to 22.231 µsec	0 µs	1280x720p 50Hz	0 to 26.653 µsec	0 µs
1920x1080p 59Hz A & 1920x1080p 59Hz B DL	0 to 14.823 µsec	0 µs	1920x1080p 50Hz A & 1920x1080p 50Hz B DL	0 to 17.771 µsec	0 µs

Additional Frame Delay (frames): This parameter affects the overall processing delay of the card. It adds supplemental frame delay to the current processing delay. This parameter will add a delay ranging from 0 to 124 interlaced frames (steps of 33 ms in 59.94 Hz and 40 ms in 50 Hz) to the current processing delay. The delay in milliseconds corresponding to the selected number of frames is computed and displayed below the slider.

Video Format	Values	Default
SD, HD	0 to 124 frames	0 frame
3G	0 to 62 frames	0 frame

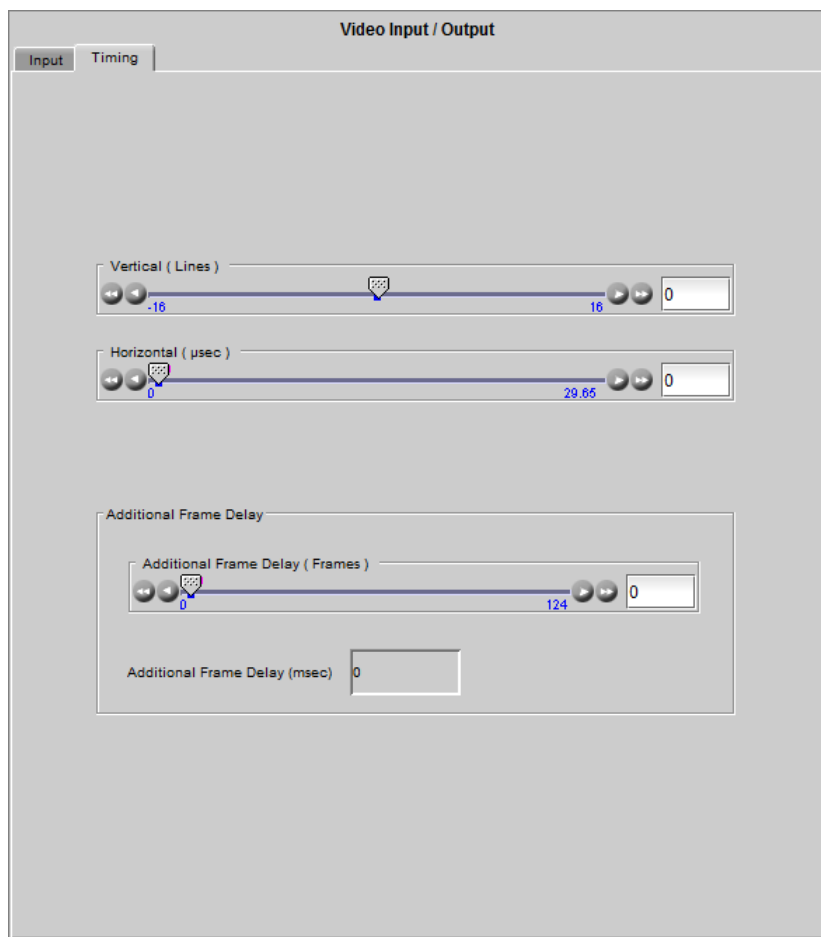

Figure 5-3 Video Input / Output panel - Timing tab

This additional frame delay in the video path is required to compensate for the delays introduced into the audio and the metadata stream by the various processing functions within the MAP-3901, such as decoding, downmixing, upmixing and encoding.

Process	Minimum additional frame delay required
Dolby E decoder	2 frames
Upmix	2 frames
Downmix	1 frame
Dolby Digital and Digital Plus encoder	3 to 5 frames
VANC Metadata Inserter	1 to 2 frames

The system icon (right-most icon at the top of the interface window) monitors the process, and will turn red when the additional frame delay is not sufficient.

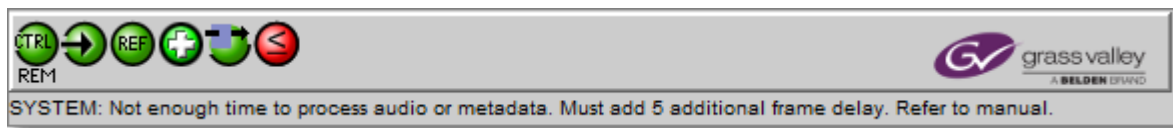

Figure 5-4 MAP-3901 internal Lip Sync problem status

MAP-3901 will save timing values for the SD format and 3G/HD formats, and will load them automatically without user intervention based on input format. Ensure the card has a video signal of the desired format before changing the configuration

On a factory default SD and 3G/HD setting regardless of the input format will be set to Zero

5.4 Reference Panel

This panel allows the selection of the reference to be used by the MAP-3901.

Reference Presence – the icons show the presence and status of the various reference sources. For the external reference, the format is shown in the External Format window.

Icon	Carrier	Format
Grey	None or not valid	N/A
Yellow	Present & valid	Valid, but not supported
Green	Present & valid	Valid and supported

External Format	Supported
NTSC	Yes
PAL	Yes
1080i59HZ	(future)
1080i50HZ	(future)
720p59Hz	(future)
720p50Hz	(future)

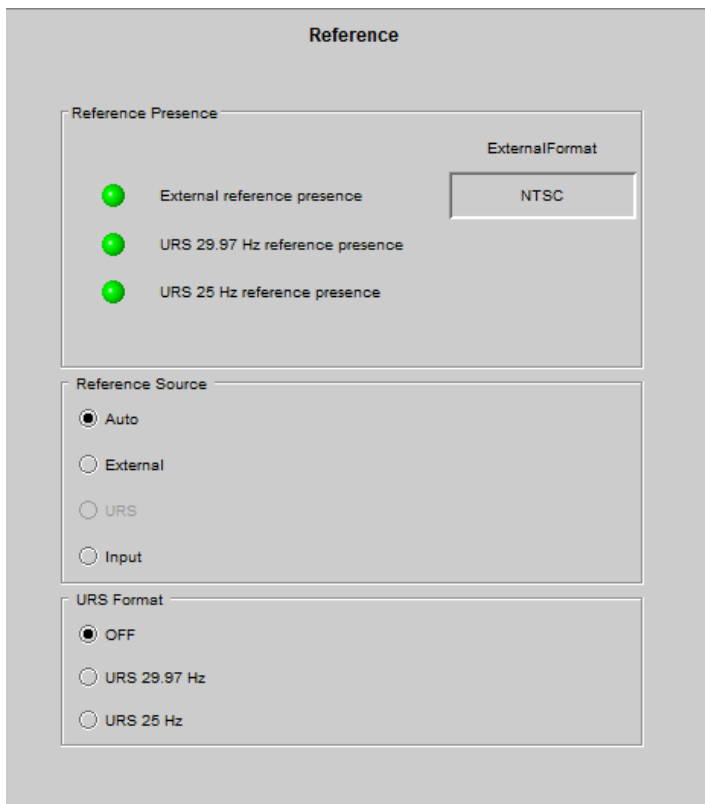

Figure 5-5 Reference panel

Reference Source – use the radio buttons to select from the following options:

Reference Source	Description	Default
Auto	This mode selects the first source detected in this order of priority: 1. External Reference input 2. URS 3. Selected Input signal	Auto
External	Selects the signal connected to the rear-panel REF IN connector	
URS (Universal Reference Signal)	(Universal Reference Signal) selects the internal reference from the Densité frame's backplane	
Input	Uses the currently-selected input signal.	

URS Format – use the radio buttons in the URS Format area to select whether the URS is OFF, 29.97 Hz or 25 Hz.

- When URS is OFF, the URS reference format source cannot be selected, and will also be ignored by the automatic detection mode.

URS Format Values	Default
OFF, URS 29.97 Hz, URS 25 Hz	OFF

5.5 Card processing delay

When locked on the input or without a reference, the minimum processing delay is always 1 frame for interlaced signals and 2 frames for progressive signals in all operating modes on the card.

When locked on a video reference (external or URS), The card operates in frame buffer mode. If the input is synchronous and exactly in phase with the reference, the minimum processing delay will also be 1 frame for interlaced signals and 2 frames for progressive signals. When the input is not in phase with the reference, the processing delay will vary according to the input alignment to the reference, but the output will always be phased to the reference

Video signals	Minimum Processing delay
525,625, 1080i59 and 1080i50	½ frame + 16 lines to 1 ½ frames + 16 lines
1080p59A and 1080p50A	1 frame to 2 frames
720p59, 720p50, 1080p59B DL and 1080p50B DL	1 frame to 3 frames

Up to 124 frames (62 frames for 3G) of additional processing delay can be added in steps of +1 frame (interlaced frames, i.e. 30 frames in progressive). Video output can be phased by -16 to +16 lines. Refer to 5.2.2 Section

5.6 Audio Functional Block diagram

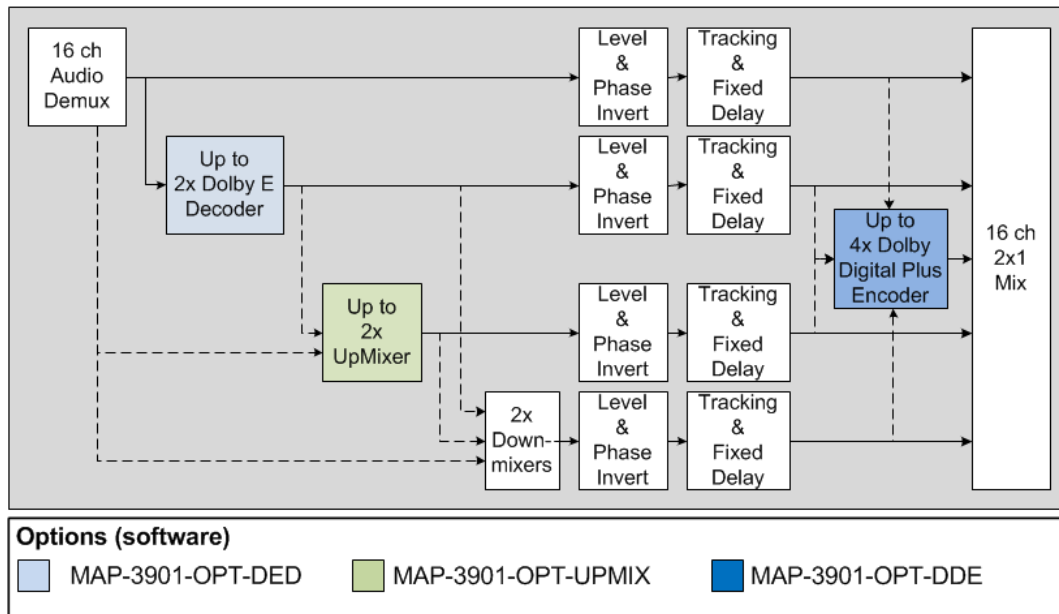
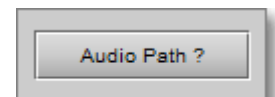

Figure 5-6 MAP-3901 Audio Block Diagram



Audio Path: Click the button to pop-up a window with the audio block diagram (see above). The window can stay open while setting audio features. This button is present in the *Embedded Audio* and *Audio Processing* tabs of Decoders, Upmixers and Downmixers.



5.7 Embedded Audio Panel

This panel provides resources to identify incoming embedded audio, and to manage levels, delay and silence detection on all 16 embedded audio channels.

Incoming Group Detected – the Status indicators turn green when audio groups 1, 2, 3 or 4 are detected in the incoming signal.

Icon	Audio Group
	Grey not present
	Green Present

Incoming Embedded Audio Presence – the Signal presence indicators monitor the audio channel presence and are related to the Silence parameters defined in the Embed CH / Silence tab (see details below): the indicator is green when an active signal is present and configurable when a silence is detected according to the “no signal” threshold and the channel detection warning.

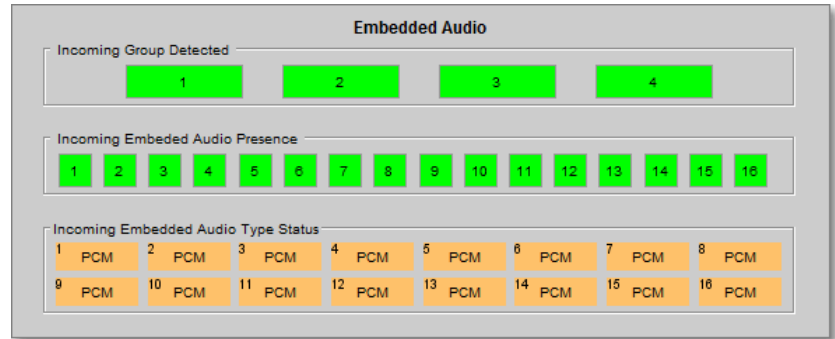





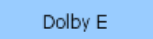

Figure 5-7 Embedded Audio Status

Move the mouse over an Incoming Embedded Audio Presence status icon and a tool tip appears below the icon providing the full audio channel name

The Signal Presence warning color can be configured by the user in the [Alarm Config Panel](#).

Icon	Audio Presence
	Grey not present
	Green Present

Incoming Embedded Audio Type Status – the icons indicate, by color and displayed text, the type of audio present in each of the 16 channels.

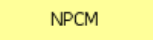
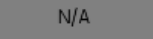
Icon	Audio Type	Note
	PCM	
	Dolby E	
	Dolby Digital	
	Dolby Digital Plus	
	Non-PCM	
	No audio	N/A will be reported when the audio group is missing

5.7.1 Embed Ch X-Y tabs

Levels sub-tab: Each of the four channels has the following controls:

Level (dB): Sets the audio gain from -96 to 12 dB in 0.5 dB steps.

Levels values	Default
-96 to 12 dB	0dB

Mute (speaker button): Mutes the selected audio channel.

Mute Values	Default
ON, OFF	OFF

Phase Invert: When checked, inverts the selected audio channel phase.

Phase values	Default
ON, OFF	OFF

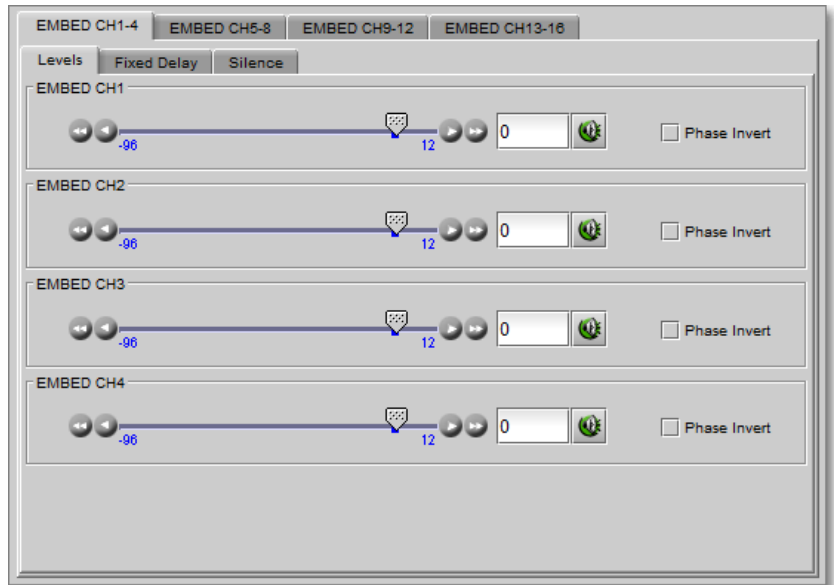

Figure 5-8 Levels sub-tab

A warning is displayed when the audio is non-PCM. For non-PCM audio, the level settings are ignored except for -96dB and the mute



Figure 5-9 Level non-PCM warning

Fixed Delay sub-tab: Although the MAP-3901 automatically matches audio and video throughput timing, provision is made for the user to insert an audio delay offset from the nominal value, in order to deal with problems such as lip-sync errors and audio phase alignment in the incoming feed. For each channel, two sliders allow the delay to be adjusted.

Coarse (ms): Adjusts the delay in milliseconds, over a range of values that depends on the Additional Frame Delay set on the timing tab in the Video Output group (see page), as follows:

Coarse values	Default
xx (see table below) to 2000ms	0ms

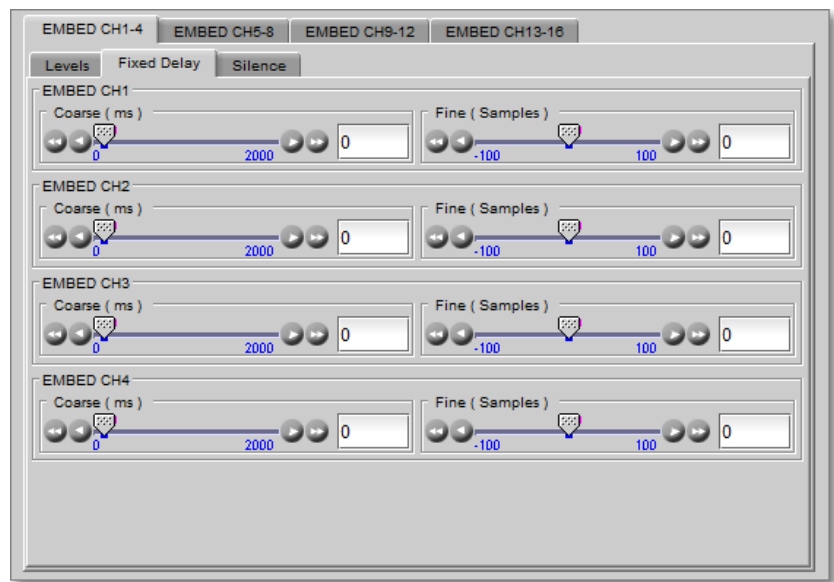

Figure 5-10 Fixed Delay sub-tab

Additional Frame Delay	Adjustment range 59.94Hz	Adjustment Range 50Hz	Notes
0	0 to 2000ms	0 to 2000ms	
1	0 to 2000ms	0 to 2000ms	
8	0 to 2000ms	0 to 2000ms	
9	-33ms to 2000ms	-40ms to 2000ms	1
10	-66ms to 2000ms	-80ms to 2000ms	
62	-1815ms to 2000ms	-2200ms to 2000ms	2
124	-3868ms to 2000ms	-4640ms to 2000ms	3

- Notes: 1. Negative delay only available after 8 frames additional delay to accommodate the worst-case delay scenario
 2. Maximum range for 1080p50 and 1080p59 formats
 3. Maximum range for 525, 625, 1080i50, 1080i59, 720p50 and 720p59 formats

Fine (audio samples): Adjusts the delay in audio sample increments, from -100 to +100 samples.

Fine values	Default
-100 to 100 samples	0 samples

A warning is displayed when the audio is non-PCM. Fixed delay can still be applied, but we should have the same fixed delay on



Figure 5-11 Fixed delay non-PCM warning

Silence sub-tab: This tab sets the card's behavior in the event of a loss or absence of audio signal. The Signal Presence indicators are then triggered according to these settings:

Silence Detect: Select which audio channels to monitor for audio silences by checking their boxes. This enables the signal presence indicators to change color when there is no signal present, which also activates the audio silence alarm. Otherwise, when checkboxes are not checked, the signal presence indicator turns grey and the audio silence alarm is not activated.

Threshold (dBFS): Signal absence is declared when the signal level is continuously lower than the *threshold* for a period longer than the *duration* setting.

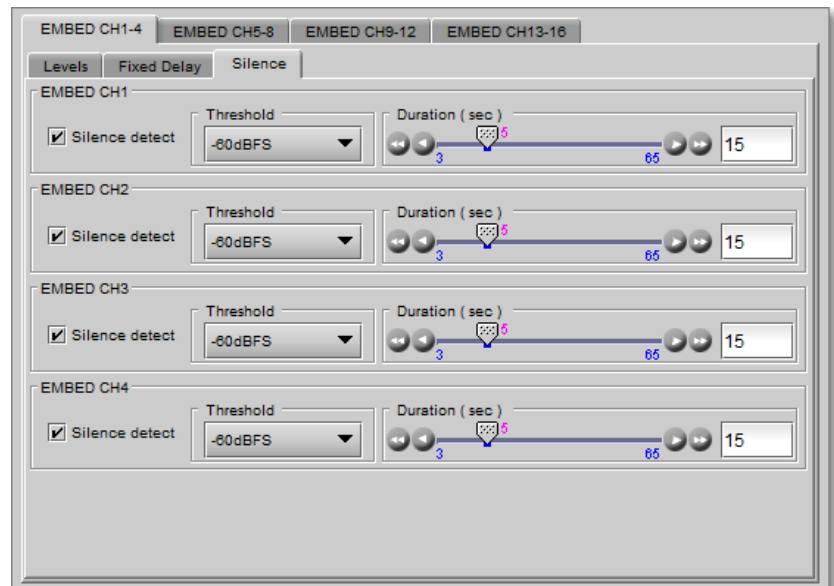

Figure 5-12 Silence sub-tab

Threshold values	Default
-100, -72, -66, -60, -54, -48 dBFS	-60 BFS

Duration (seconds): The period for which signal must be continuously below the *threshold* before an alarm can be triggered.

Duration values	Default
3 – 65 sec in 1 sec increments	15 sec

5.8 Decoders Panel

Dolby decoders are optional functions. Up to two decoders are supported, and each decoder must be enabled separately. See [Options](#) for more information about decoder options.

Note: The *Additional Frame Delay* must be set to at least two frames to compensate for decoder latency.

5.8.1 Dolby E Decoder n tab

Controls – this section controls the decoder

Bitstream Detection Mode: Use the pulldown to select the detection mode:

- Auto: Detect the incoming audio stream
 - Decode it if it is Dolby E
 - Mute it otherwise
- OFF: Detection disabled

Mode values	Default
AUTO, OFF	OFF

Input selection: Use the pulldown to select the embedded channel pair that will be sent to the decoder.

Input selection	Default
EMBED CH1&2 to EMBED CH15&16	DEC 1: EMBED CH1&2 DEC 2: EMBED CH3&4

The panel displays the decoded signal format as a graphic, and identifies the output audio channels for the decoded program elements in text boxes, e.g.:

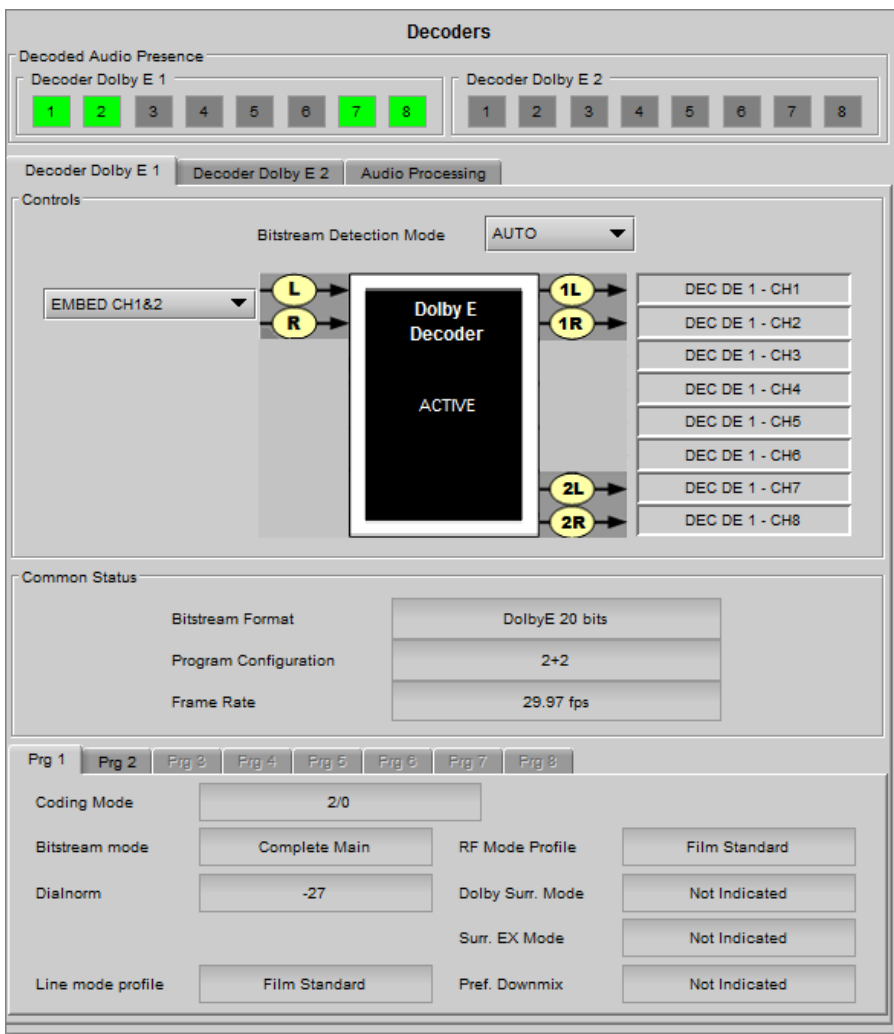



Figure 5-13 Decoders Panel

DEC DE 1 – CH3 refers to decoded output from decoder 1, appearing on channel 3. For a 5.1 program, this would be the Center channel.

Within the graphic, the current decoder status is reported:

Operating Status	Functionality
OFF	Decoder is manually stopped
ACTIVE	Dolby E is detected and decoder is working
Stopped – Audio Input Error [in RED]	Incoming audio is not a Dolby E stream, or an invalid input is detected

Decoded Audio Presence – decoded audio channel activity will be reported on the “Decoded Audio Presence” section. Move the mouse over a presence status and a tool tip appears below the icon providing the full audio channel name

Icon	Audio Presence
	Grey not present
	Green Present

Common Status – reports details of the contents of the selected embedded channel pair:

Status Topic	Values	Note
Bitstream Format	Dolby-E 16 bits, Dolby E 20 bits or Dolby E 24 bits	If Dolby E, it shows the number of bits (16, 20 or 24). If non-Dolby-E, the signal type is reported if possible; otherwise N/A.
Program Configuration	5.1+2, 5.1+ 2x1, 4+4, 4+2x2, 4+2+2x1, 4+4x1, 4x2, 3x2 + 2x1, 2x2+4x1, 2+6x1, 8x1, 5.1, 4+2, 4+2x1, 3x2, 2x2+2x1, 2+4x1, 6x1, 4, 2+2, 2+2x1, 4x1, 7.1, 7.1 Screen	Indicates the programs carried in the embedded channel pair
Frame Rate	29.97 fps, 25 fps	The card supports 29.97 fps and 25 fps.

Prg 1 to 8 – for each detected program (up to 8), a tab is activated at the bottom of the screen to indicate some program details:

Status Topic	Values
Coding Mode	1/0, 2/0, 3/0, 3.0L, 2/1, 2/1L, 3/1, 3/1L, 2/2, 2/2L, 3/2, 3/2L
Bitstream Mode	Complete Main, Music and Effects, Visually Impaired, Hearing Impaired, Dialogue, Commentary, Emergency, Karaoke
Dialnorm	-1dBFS to -31dBFS
Line Mode Profile	None, Film Standard, Film light, Music standard, Music light, Speech
RF Mode Profile	None, Film Standard, Film light, Music standard, Music light, Speech
Dolby Surround Mode	Not Indicated, Not Dolby Surround Encoded, Dolby surround Encoded
Surround EX Mode	Not indicated, Not Surround EX Encoder, Surround EX Encoder
Preferred Stereo Downmix	Not indicated, LtRt Preferred, LoRo Preferred

5.8.2 Audio Processing

Four main tabs provide access to all 16 of the decoded audio output channels:

- Decoder 1 output, channels 1-4
- Decoder 1 output, channels 5-8
- Decoder 2 output, channels 1-4
- Decoder 2 output, channels 5-8

Each of these tabs has three sub-tabs:

Levels sub-tab: each of the four decoded channels has the following controls:

Level (dB): Sets the audio gain from -96 to 12 dB in 0.5 dB steps

Level values	Default
-96 to 12 dB	0 dB

Mute (speaker button): Mutes the selected audio channel

Mute values	Default
ON, OFF	OFF

Phase Invert: When checked, inverts the selected audio channel phase.

Phase values	Default
ON, OFF	OFF

Fixed Delay sub-tab: Although the MAP-3901 automatically matches audio and video throughout timing, provision is made for the user to insert an audio delay offset from the nominal value, in order to deal with problems such as lip-sync errors and audio phase alignment in the incoming feed. For each channel, two sliders allow the delay to be adjusted.

Coarse (ms): Adjusts the delay in milliseconds, over a range of values that depends on the Additional Frame Delay set on the timing tab in the Video Output group (see page), as follows:

Coarse values	Default
xx (see table below) to 2000ms	0ms

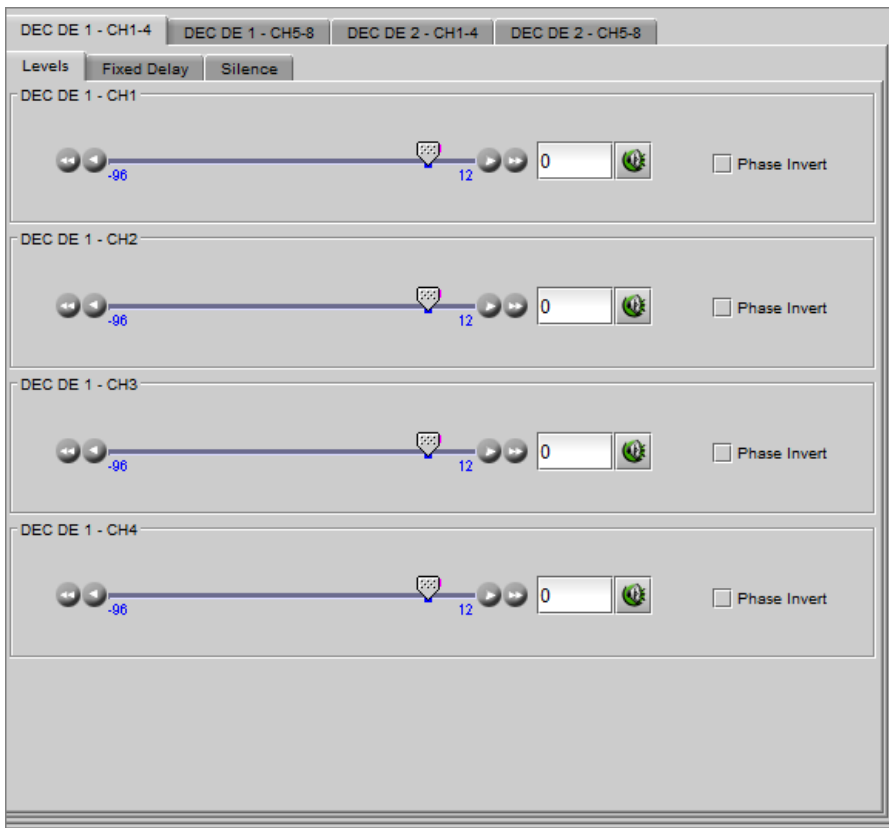

Figure 5-14 Decoders Audio Processing - Levels tab

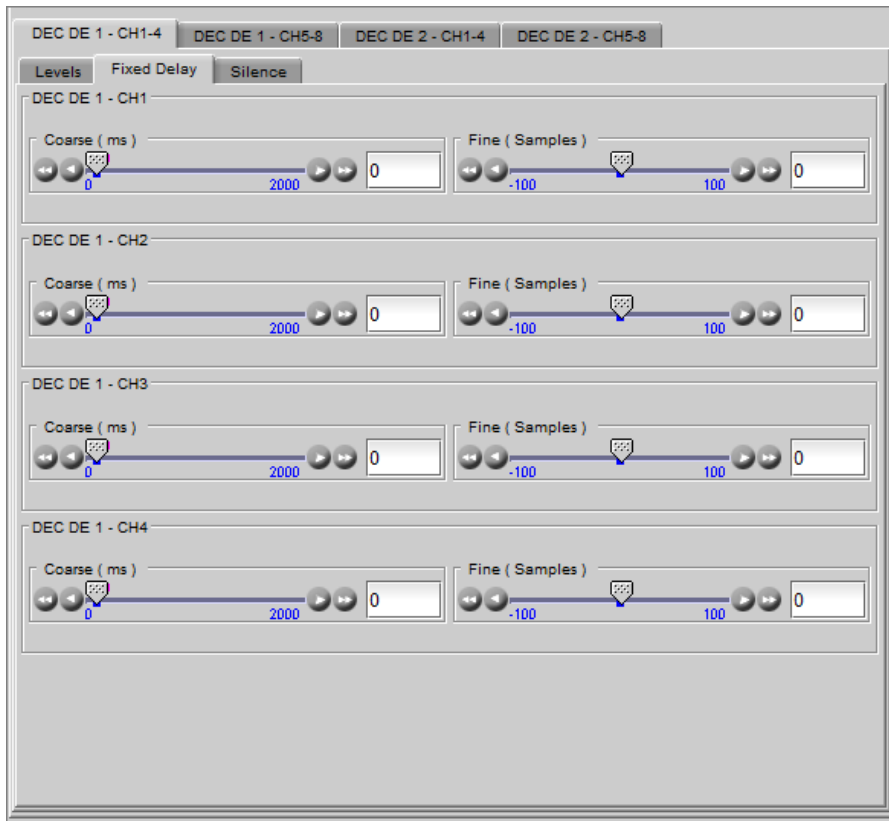

Figure 5-15 Decoders Audio Processing - Fixed Delay tab

Additional Frame Delay	Adjustment range 59.94Hz	Adjustment Range 50Hz	Notes
0	0 to 2000ms	0 to 2000ms	
1	0 to 2000ms	0 to 2000ms	
:			
8	0 to 2000ms	0 to 2000ms	
9	-33ms to 2000ms	-40ms to 2000ms	1
10	-66ms to 2000ms	-80ms to 2000ms	
:			
62	-1815ms to 2000ms	-2200ms to 2000ms	2
:			
124	-3868ms to 2000ms	-4640ms to 2000ms	3

- Notes:
1. Negative delay only available after 8 frames additional delay to accommodate worst-case delay scenario
 2. Maximum range for 1080p50 and 1080p59 formats
 3. Maximum range for 525, 625, 1080i50, 1080i59, 720p50 and 720p59 formats

Fine (audio samples): Adjusts the delay in audio sample increments, from -100 to +100 samples.

Fine values	Default
-100 to 100 samples	0 samples

Silence sub-tab: This tab sets the card’s behavior in the event of a loss or absence of audio signal. The Signal Presence indicators are then triggered according to these settings:

Silence Detect: Select which audio channels to monitor for audio silences by checking their boxes. This enables the signal presence indicators to change color when there is no signal present, which also activates the audio silence alarm. Otherwise, when checkboxes are not checked, the signal presence indicator turns grey and the audio silence alarm is not activated

Threshold (dBFS): Signal absence is declared when the signal level is continuously lower than the *threshold* for a period longer than the *duration* setting.

Threshold values	Default
-100, -72, -66, -60, -54, -48 dBFS	-60 dBFS

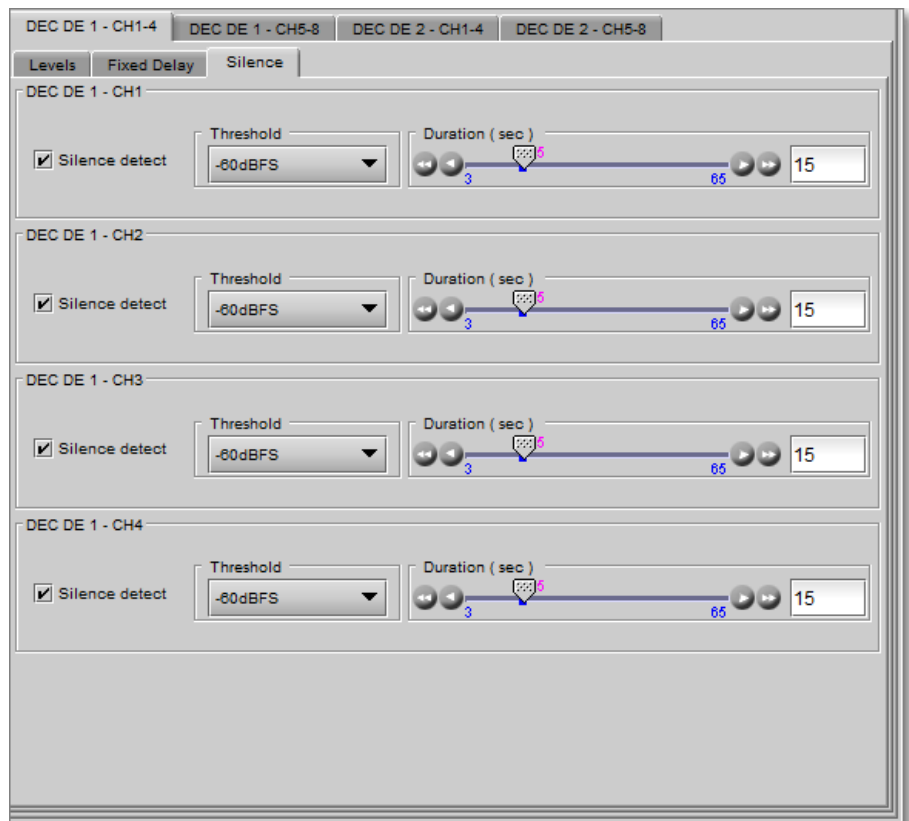

Figure 5-16 Decoders Audio Processing – Silence tab

Duration (seconds): The period for which signal must be continuously below the *threshold* before an alarm can be triggered.

Duration values	Default
3 – 65 sec in 1 sec increments	15 sec

5.9 Upmix Panel

The upmix functionality allows us to create a 5.1 audio program from a stereo (2-channel) input.

Two upmixers are available, each configured from its own tab. They are identical, so the description that follows applies to both.

The upmixers are optional functions. Panels are enabled when the appropriate options are purchased. See [Options](#) for more information.

Note: The *Additional Frame Delay* must be set to at least two frames to compensate for upmix latency.

5.9.1 Upmix n tab

The graphic indicates source channels, operating status, and output channels.

Input Controls – use the pulldowns to select the input source for the upmixer. Available choices depend on whether decoders are activated.

Available Inputs	Condition
EMBED CH1 to 16	Always
DEC DE 1 - CH1 to CH8	MAP-3901-OPT-DED-1 active or MAP-3901-OPT-DED-2 active
DEC DE 2 - CH1 to CH8	MAP-3901-OPT-DED-2 active





Figure 5-17 Upmix panel

Note that if one of the selected channels is non-PCM, the upmixer outputs will be muted, and a warning will be posted in the graphic.

The graphic displays the current operational status of the Upmix:

Operating Status	Functionality
OFF	Upmix is manually stopped
STOPPED Audio Input Error [in RED]	Input audio is non-PCM. Upmix outputs are muted
ACTIVE	Left and Right inputs are upmixed
PASSTHROUGH	All inputs are passed through unprocessed

Upmixed Audio Presence – upmixed audio channel activity will be reported on the “Upmixed Audio Presence” section. Move the mouse over a presence status and a tool tip appears below the icon providing the full audio channel name

Icon	Audio Present
 Grey	not present
 Green	Present

Upmix – here are the upmix settings:

Operation Mode: Use the pulldown to select the mode:

Operating Mode	Functionality	Default
OFF	Upmix outputs are muted	OFF
ON	2.0 (left, right) is upmixed to 5.1	
PASS	5.1 inputs are passed through to the upmix outputs	
AUTO 5.1/2.0	Signal format is detected; 2.0 is upmixed and 5.1 is passed through (see below)	

Auto 5.1/2.0 – the auto-detect function is based on detecting activity in the center channel (input CH3). The user sets:

Threshold (dBFS): The value below which silence will be considered to have been detected in the center channel.

Threshold values	Default
-100 dBFS to -48 dBFS	-60 dBFS

No signal delay (ms) – The period over which silence must be continuously detected before the input is determined to be 2.0.

Duration values	Default
30ms to 2000ms	500 ms

Effect – the “Effect” is the result of extra processing applied to the upmixed signal. Since upmix creates “something from nothing”, it is desirable to provide a means of modifying the results obtained from an arbitrary analysis of the stereo input to create a 5.1 surround signal. This provides an optional artistic input that allows the most pleasing result.

Use the slider data box to enter a result from 0 to 10. The value 7 represents no modification to the nominal standard upmix.

Stereo – controls the left (L) and right (R) output channels together.

Level (dB) : Adjust the L and R channels output level

Stereo level values	Default
-24 dB to +6 dB	-5 dB

Mute:  Click the icon to mute the L and R output channels. The level setting is not changed.

Stereo Mute values	Default
ON, OFF	OFF

Width : Set the stereo image width

Stereo width values	Default
0 to 31	27

Center – controls the center (C) output channel.

Level (dB): Adjust the center channel output level

Center level values	Default
-24 dB to +6 dB	1 dB

Mute:  Click the icon to mute the C output channel. The level setting is not changed.

Center mute values	Default
ON, OFF	OFF

LFE – controls the LFE output channel.

Level (dB): Adjust the LFE channel output level:

LFE level values	Default
-24 dB to +6 dB	-10 dB

Mute:  Click the icon to mute the LFE output channel.

LFE mute values	Default
ON, OFF	OFF

Frequency Filter (Hz): Use the pulldown to select the upper cut-off frequency in the LFE channel.

LFE frequency Filter	Default
80 Hz, 120 Hz	80 Hz

Surround – controls the quality of the left surround (Ls) and right surround (Rs) channels together.

Surround Mode: Use the pulldown to select one of three factory-supplied preset modes:

Surround mode value	Default
Speech, Music, Movie	Speech

Level (dB): Adjust the level of the Ls and Rs channels output level.

Surround level values	Default
-24 dB to +6 dB	-5 dB

Mute:  Click the icon to mute the Ls & Rs output channels. The level setting is not changed.

Surround mute values	Default
ON, OFF	OFF

Delay (ms): Introduce a delay into the Ls and Rs output channels, with respect to the L and R output channels.

Surround Delay values	Default
0 ms to 20 ms	16 ms

Upmix Presets – the MAP-3901 provides eight upmix Presets, each containing values for all of the variables that can be set in this panel.

- Three are factory-provided presets: Factory Music, Factory Speech, Factory Movie.
- Five are user presets that allow the user to store a complete set of parameter adjustments, and recall them at a later time: UPMIX 1, UPMIX 2,, UPMIX 5.

Preset	Default
Factory Music, Factory Speech, Factory Movie, UPMIX 1, UPMIX 2,, UPMIX 5	Factory Speech

Select a preset using the pulldown.

- *Load...* : Load the values stored in the selected preset into the card, replacing the values currently shown in the panel. A pop-up warning reminds you that the current values will be over-written and lost.
- *Save...* : Copy the parameter values currently displayed in the panel into the selected preset memory. A pop-up warning reminds you that the values currently saved in the preset will be over-written and lost.

Edit Labels: Opens a dialog allowing you to change the names of the UPMIX 1 through UPMIX 5 presets to any desired names.

5.9.3 Audio Processing

Two main tabs provide access to all 12 of the upmixed audio output channels:

- Upmix 1, channels 1-6
- Upmix 2, channels 1-6

Each of these tabs has three sub-tabs:

Levels sub-tab: each of the six upmixed channels has the following controls:

Level (dB): Sets the audio gain from -96 to 12 dB in 0.5 dB steps

Levels values	Default
-96 to 12 dB	0dB

Mute (speaker button): Mutes the selected audio channel

Mute Values	Default
ON, OFF	OFF

Phase Invert. When checked, inverts the selected audio channel phase

Phase values	Default
ON, OFF	OFF

Fixed Delay sub-tab: although the MAP-3901 automatically matches audio and video throughput timing, provision is made for the user to insert an audio delay offset from the nominal value, in order to deal with problems such as lip-sync errors and audio phase alignment in the incoming feed. For each channel, two sliders allow the delay to be adjusted.

Coarse (ms): Adjusts the delay in milliseconds, over a range of values that depends on the Additional Frame Delay set on the timing tab in the Video Output group (see page), as follows:

Coarse values	Default
xx (see table below) to 2000ms	0ms



Figure 5-19 Upmixers Audio Processing - Levels tab

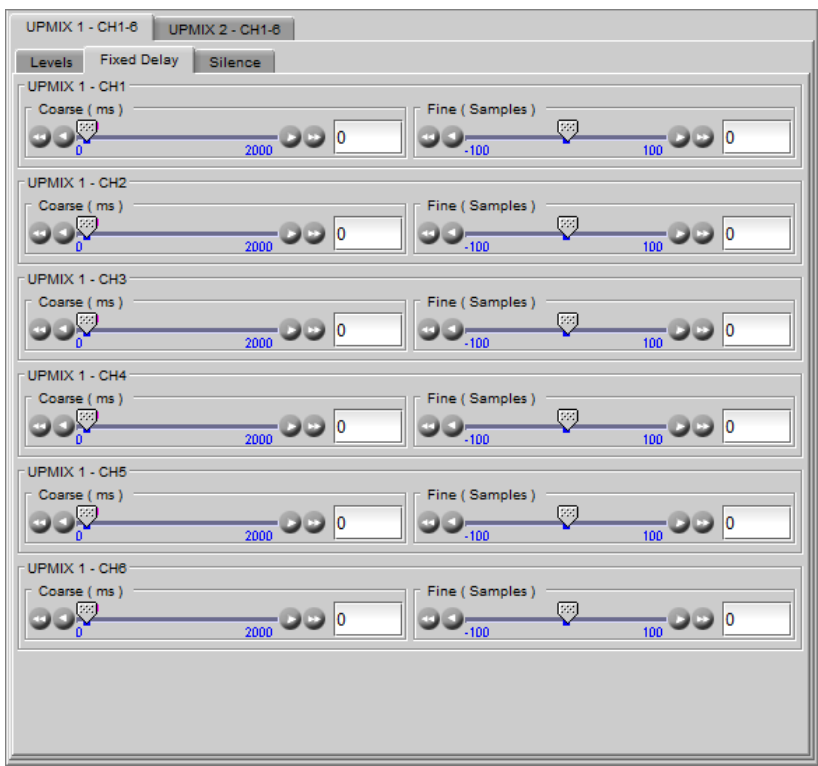

Figure 5-18 Upmixers Audio Processing - Fixed delay tab

Additional Frame Delay	Adjustment range59.94Hz	Adjustment Range50Hz	Notes
0	0 to 2000ms	0 to 2000ms	
1	0 to 2000ms	0 to 2000ms	
8	0 to 2000ms	0 to 2000ms	
9	-33ms to 2000ms	-40ms to 2000ms	1
10	-66ms to 2000ms	-80ms to 2000ms	
62	-1815ms to 2000ms	-2200ms to 2000ms	2
124	-3868ms to 2000ms	-4640ms to 2000ms	3

- Notes: 1. Negative delay only available after 8 frames additional delay to accommodate worst-case delay scenario
 2. Maximum range for 1080p50 and 1080p59 formats
 3. Maximum range for 525, 625, 1080i50, 1080i59, 720p50 and 720p59 formats

Fine (audio samples): Adjusts the delay in audio sample increments, from -100 to +100 samples.

Fine values	Default
-100 to 100 samples	0 samples

Silence sub-tab: This tab sets the card's behavior in the event of a loss or absence of audio signal. The Signal Presence indicators are then triggered according to these settings:

Silence Detect: select which audio channels to monitor for audio silences by checking their boxes. This enables the signal presence indicators to change color when there is no signal present, which also activates the audio silence alarm. Otherwise, when checkboxes are not checked, the signal presence indicator turns grey and the audio silence alarm is not activated

Threshold (dBFS): Signal absence is declared when the signal level is continuously lower than the *threshold* for a period longer than the *duration* setting.

Threshold values	Default
-100, -72, -66, -60, -54, -48 dBFS	-60 dBFS

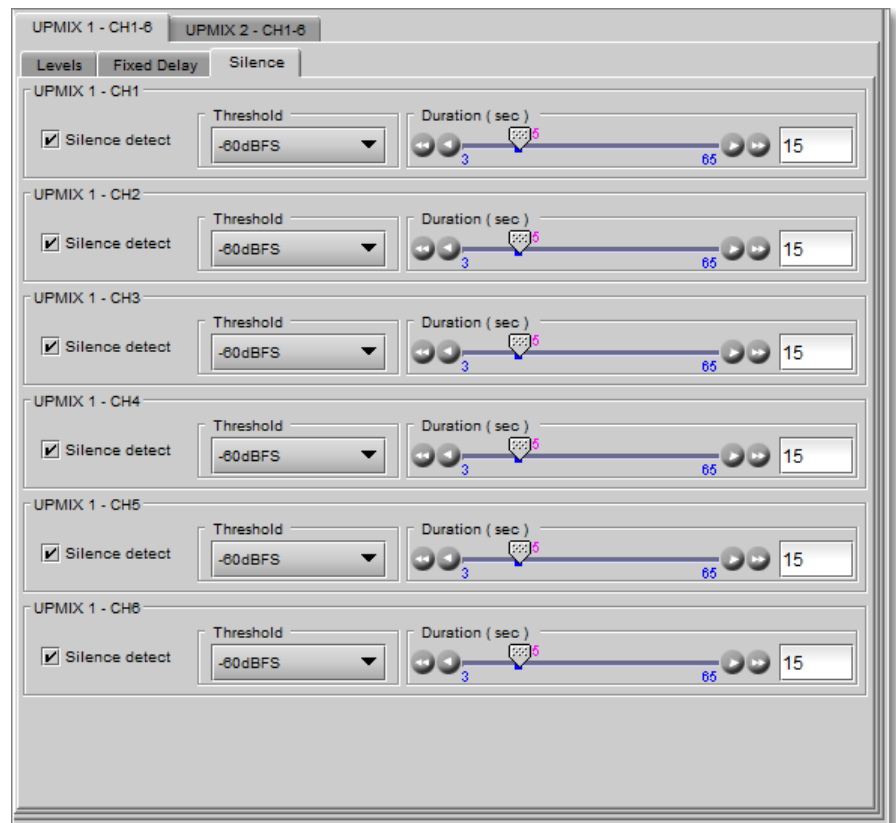

Figure 5-20 Upmixers Audio Processing - Silence tab

Duration (seconds): The period for which signal must be continuously below the threshold before an alarm can be triggered.

Duration values	Default
3 – 65 sec in 1 sec increments	15 sec

5.10 Downmix Panel

Downmix functionality allows to mix a 5.1 channel surround signal down to either an LtRt or an LoRo 2-channel signal.

Two downmixers are available, each configured from its own tab. They are identical, so the description that follows applies to both.

Note: The *Additional Frame Delay* must be set to at least one frame to compensate for downmix LtRt latency.

5.10.1 Downmix n tab

The graphic indicates source channels, operating status, and output channels.

Input Control – use the pulldowns to select the input source for the downmixer. Available choices depend on whether decoders or upmixers are active:

Available Inputs	Condition
EMBED CH1 to16	Always
DEC DE 1 - CH1 to CH8	MAP-3901-OPT-DED-1 active or MAP-3901-OPT-DED-2 active
DEC DE 2 - CH1 to CH8	MAP-3901-OPT-DED-2 active
UPMIX 1 - CH1 to CH6	MAP-3901-OPT-UPMIX-1 active or MAP-3901-OPT-UPMIX-2 active
UPMIX 2 - CH1 to CH6	MAP-3901-OPT-UPMIX-2 active

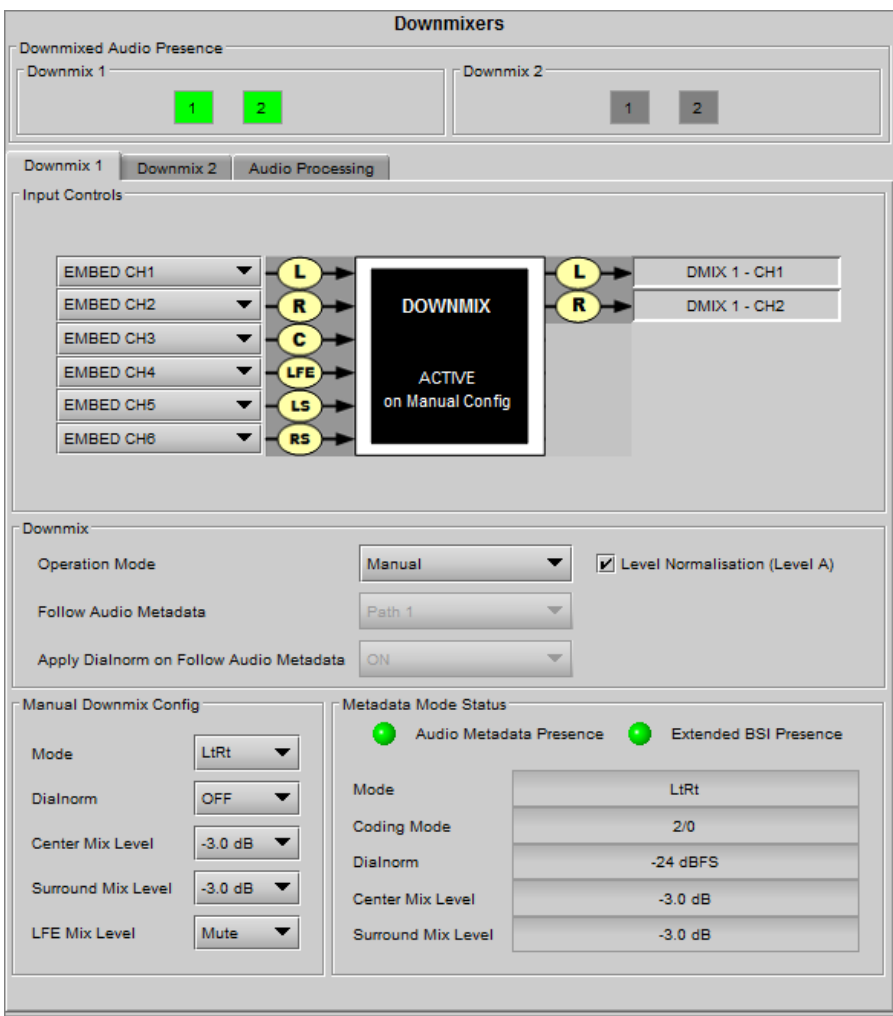



Figure 5-21 Downmixers panel

Note: If one of the selected channels is non-PCM, the downmixer outputs will be muted, and a warning will be posted in the graphic.

The graphic displays the current operational status of the Downmix:

Operating Status	Functionality
OFF	Downmix is manually stopped, downmix outputs are muted
ACTIVE on Manual Config	Downmix is following manual config
ACTIVE on Audio Metadata Config	Downmix is following selected audio metadata
ACTIVE on Manual Config Missing Extended BSI [in RED]	Extended BSI is missing, downmix is following manual config, downmix outputs are muted
ACTIVE on Manual Config Missing Audio Metadata [in RED]	Audio metadata is missing, downmix is following manual config, downmix outputs are muted
PASSTHROUGH – all inputs are passed through unprocessed	Detected coding mode is different from 3/2, 3/2L. Left and right are passed through to downmix outputs
STOPPED Audio Inputs Error	Input audio is non-PCM, downmix outputs are muted

Downmixed Audio Presence – Downmixed audio channel activity will be reported in the “Downmixed Audio Presence” section. Move the mouse over a presence status and a status message appears below the icon providing the full audio channel name

Icon	Audio Presence
	Grey Not present
	Green Present

Downmix – here are the downmix settings

Operation Mode: Use the pull-down to select the mode of operation:

Operation mode values	Description	Default
OFF	Downmix is disabled, the downmix output channels are muted	OFF
Manual	Follows downmix parameters set by the user in the lower part of this panel	
Follow Audio Metadata	downmix follows the Downmix parameters of the selected Audio Metadata path	

Follow Audio Metadata: This setting is enabled on Follow Audio metadata operation mode. Downmix can follow any of the audio metadata path

Follow Audio Metadata	Default
Path 1, Path 2, Path 3 and Path 4	Path 1

Note : Downmix selects the audio metadata program 1 automatically (NB the 5.1 program is always the first program).

Apply Dialnorm on Follow Audio Metadata: Dialnorm on follow audio metadata can be disabled

Apply Dialnorm on follow Audio Metadata	Default
ON, OFF	ON

Level Normalization {Level A}: Select the checkbox to turn normalization ON.

Downmix output level is normalized based on the applied mix levels to provide a uniform output over the range of mix levels available. Clipping will never occur, even with full scale input channels and mix levels

Normalization values	Default
ON, OFF	ON

Manual Downmix Config – use the pull-downs to set these parameters:

Parameter	Possible Values	Default
Mode	LtRt, LoRo	LtRt
Dialnorm	OFF, -31 dBFS to -1 dBFS	OFF
Center Mix Level	+3.0 dB , +1.5 dB , 0.0 dB , -1.5 dB , -3.0 dB , -4.5 dB , -6.0 dB and Mute	-3.0 dB
Surround Mix Level	+3.0 dB , +1.5 dB , 0.0 dB , -1.5 dB , -3.0 dB , -4.5 dB , -6.0 dB and Mute	-3.0 dB
LFE Mix Level	+10.0 dB , + 9.0 dB , +7.5 dB , +6.0 dB , +4.5 dB , +3.0 dB , +1.5 dB , 0.0 dB , -1.5 dB , -3.0 dB , -4.5 dB , -6.0 dB and Mute	Mute

The diagrams below show the configurations of the Lt/Rt downmix and the Lo/Ro downmix.

- Lt/Rt downmixes 5.1 channels into an Lt/Rt (Left total/Right total) matrix surround encoded stereo pair.
- Lo/Ro downmixes 5.1 channels into an Lo/Ro (Left only/Right only) stereo pair, i.e. a conventional stereo signal.

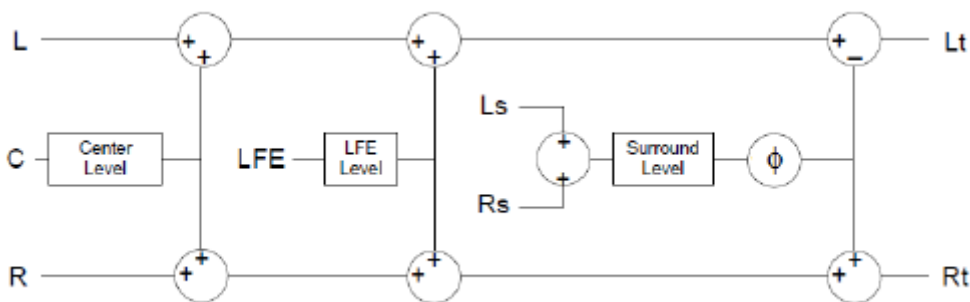

Figure 5-22 Lt/Rt surround Sound downmixer

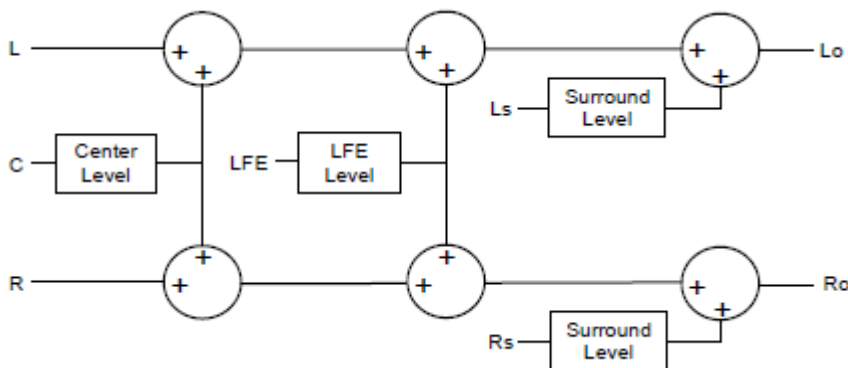





Figure 5-23 Lo/Ro Stereo downmixer

Metadata Mode Status – when Follow Audio Metadata mode is selected, this section of the panel is active.

Status icons Audio Metadata Presence: report audio metadata presence of the selected path

Icon	Carrier
	Grey Not Present
	Green Present and valid

Status icons Extended BSI Presence: report extended BSI presence in the audio metadata of the selected path

Icon	Carrier
	Grey Not Present
	Green Present and valid

The data boxes in this section report the detected downmix parameters:

Status Topic	Values
Mode	LtRt, LoRo, Not Indicated (LtRt Applied)
Coding Mode	1/0, 2/0, 2/1, 2/1L, 3/0, 3/0L, 2/2, 2/2L, 3/1, 3/1L, 3/2, 3/2L
Dialnorm	-31 dBFS to -1 dBFS
Center Mix Level	-6.0 dB to +3.0dB and CUT
Surround Mix Level	-6.0 dB to +3.0dB and CUT

Note : LFE Mix Level is not available from the audio metadata path; the user must manually set the LFE mix level in the *Follow Audio Metadata* mode, so that control remains available.

The functionality of the “Follow Audio Metadata” downmix mode is affected by these items.

Audio Metadata	Extended BSI	Coding Mode	Downmix Status	Downmix Config	Comments
Present	Present	3/2, 3/2L	ACTIVE	Audio Metadata config	Downmix works only for 3/2 and 3/2L coding modes
		Others	PASSTHROUGH	N/A	Left and Right channels are passed through unchanged
	Present, but Preferred Stereo Downmix is <u>Not Indicated</u>	3/2, 3/2L	ACTIVE	Audio Metadata config	Defaults to <u>Lt/Rt downmix</u>
	Not Present	N/A	ACTIVE	Manual config	
Not Present	N/A	N/A	ACTIVE	Manual config	

5.10.2 Audio Processing

Levels sub-tab: Each of the two downmixed channels has the following controls:

Level (dB): Sets the audio gain from -96 to 12 dB in 0.5 dB steps.

Levels values	Default
-96 to 12 dB	0dB

Mute (speaker button): Mutes the selected audio channel

Mute Values	Default
ON, OFF	OFF

Phase Invert: When checked, inverts the selected audio channel phase.

Phase values	Default
ON, OFF	OFF

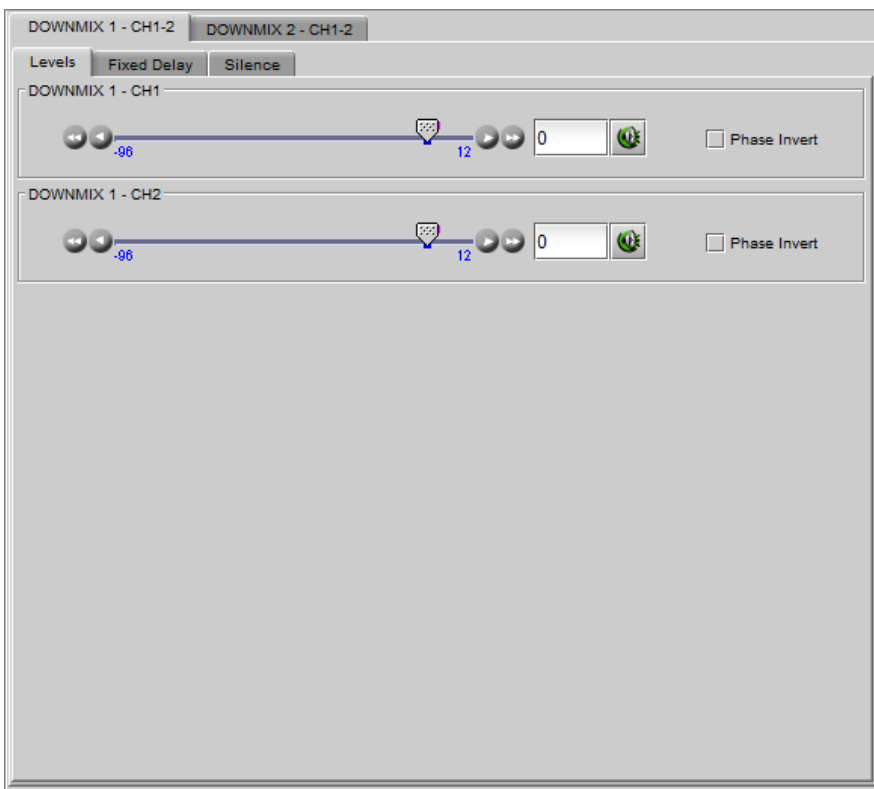

Figure 5-24 Downmixers Audio Processing - Levels

Fixed Delay sub-tab: Although the MAP-3901 automatically matches audio and video throughput timing, provision is made for the user to insert an audio delay offset from the nominal value, in order to deal with problems such as lip-sync errors and audio phase alignment in the incoming feed. For each channel, two sliders allow the delay to be adjusted.

Coarse (ms): Adjusts the delay in milliseconds, over a range of values that depends on the Additional Frame Delay set on the timing tab in the Video Output group (see page), as follows:

Coarse values	Default
xx (see table below) to 2000ms	0ms

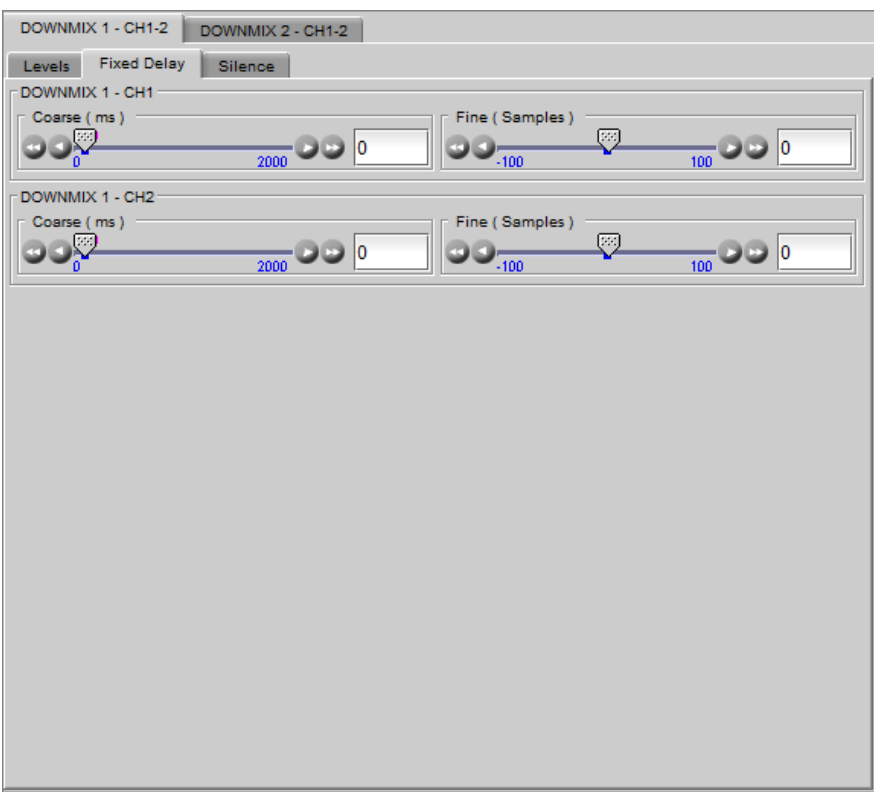

Figure 5-25 Downmixers Audio Processing – Fixed Delay

Additional Frame Delay	Adjustment range 59.94Hz	Adjustment Range 50Hz	Notes
0	0 to 2000ms	0 to 2000ms	
1	0 to 2000ms	0 to 2000ms	
...	
8	0 to 2000ms	0 to 2000ms	
9	-33ms to 2000ms	-40ms to 2000ms	1
10	-66ms to 2000ms	-80ms to 2000ms	
...			
62	-1815ms to 2000ms	-2200ms to 2000ms	2
...	
124	-3868ms to 2000ms	-4640ms to 2000ms	3

- Notes: 1. Negative delay only available after 8 frames additional delay to accommodate worst-case delay scenario
 2. Maximum range for 1080p50 and 1080p59 formats
 3. Maximum range for 525, 625, 1080i50, 1080i59, 720p50 and 720p59 formats

Fine (audio samples): Adjusts the delay in audio sample increments, from -100 to +100 samples.

Fine values	Default
-100 to 100 samples	0 samples

Silence sub-tab: This tab sets the card's behavior in the event of a loss or absence of audio signal. The Signal Presence indicators are then triggered according to these settings:

Silence Detect: select which audio channels to monitor for audio silences by checking their boxes. This enables the signal presence indicators to change color when there is no signal present, which also activates the audio silence alarm. Otherwise, when checkboxes are not checked, the signal presence indicator turns grey and the audio silence alarm is not activated

Threshold (dBFS): Signal absence is declared when the signal level is continuously lower than the *threshold* for a period longer than the *duration* setting.

Threshold values	Default
-100, -72, -66, -60, -54, -48 dBFS	-60 dBFS

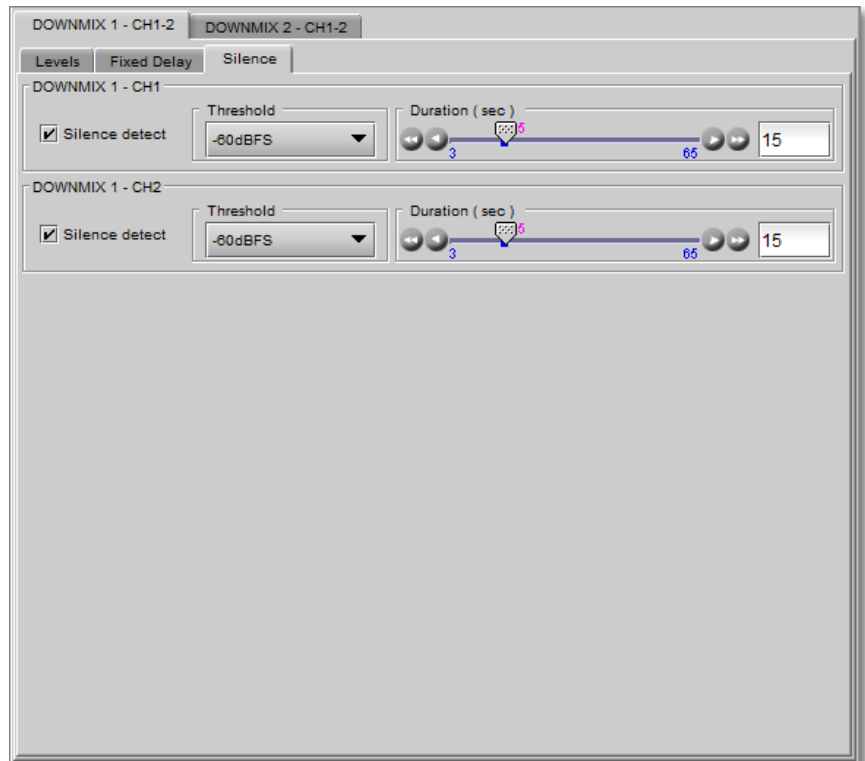

Figure 5-26 Downmixers Audio Processing – Fixed Delay

GUIDE TO INSTALLATION AND OPERATION

Duration (seconds): The period for which signal must be continuously below the *threshold* before an alarm can be triggered.

Duration values	Default
3 – 65 sec in 1 sec increments	15 sec

5.11 Encoders Panel

The MAP-3901 supports up to four Dolby Digital and Dolby Digital Plus encoders.

- These encoders convert PCM signals into Dolby Digital or Dolby Digital Plus compressed signals.
- Any other audio type will not be encoded, and the encoder outputs will be muted.
- Audio metadata is required for the encoding process.

Dolby Digital and Dolby Digital Plus encoders are optional functions.

- Each of the four possible encoders must be activated separately with the purchase of a license. See the [Options](#) panel for activation details.

A separate tab is accessible in this panel for each active encoder. All panels are identical, so the descriptions here apply to all of them.

Note: The *Additional Frame Delay* must be set to at least 3 (50Hz formats) or 4 frames (59Hz formats) to compensate for encoder latency. If using audio metadata coming from VANC stream, an additional frame will be needed



Figure 5-27 Encoders

5.11.1 Encoder Dolby Digital n tab

Shuffler Inputs – use the pulldowns to select the inputs to the Dolby Digital and Dolby Digital Plus encoder. The availability of some inputs depends on whether decoder or upmix options have been activated. This chart shows all the possibilities.

Inputs listed on pull-down	Availability / Required options
Embed CH1 to CH16	Always
DMIX 1 - CH1 to CH2	Always
DMIX 2 - CH1 to CH2	Always
DEC DE 1 - CH1 to CH8	MAP-3901-OPT-DED-1 or MAP-3901-OPT-DED-2 is active
DEC DE 2 - CH1 to CH8	MAP-3901-OPT-DED-2 is active
UPMIX 1 - CH1 to CH6	MAP-3901-OPT-UPMIX-1 or MAP-3901-OPT-UPMIX-2 is active
UPMIX 2 - CH1 to CH6	MAP-3901-OPT-UPMIX-2 is active

Note: All of the selected audio inputs may have been processed by changing *level/phase* and/or *fixed delay*.

The input labels on the displayed graphic follow the *coding mode* parameter from the selected Audio Metadata program, as reported in the *Status* section at the bottom of the panel:

Coding Mode	Input CH 1	Input CH 2	Input CH 3	Input CH 4	Input CH 5	Input CH 6
1/0	-	-	1C	-	-	-
2/0	1L	1R	-	-	-	-
3/0	1L	1R	1C	-	-	-
3.0L	1L	1R	1C	1LFE	-	-
2/1	1L	1R	-	-	1S	-
2/1L	1L	1R		1LFE	1S	-
3/1	1L	1R	1C	-	1S	-
3/1L	1L	1R	1C	1LFE	1S	-
2/2	1L	1R	-	-	1Ls	1Rs
2/2L	1L	1R	-	1LFE	1Ls	1Rs
3/2	1L	1R	1C	-	1Ls	1Rs
3/2L	1L	1R	1C	1LFE	1Ls	1Rs

The encoder graphic indicates the operating status of the encoder:

Encoder	Description	Notes
OFF	Encoder disabled, encoder outputs are muted	Encoder is manually disabled.
ACTIVE	Encoder enabled	
STOPPED, Audio Input Error [in RED]	Selected audio in non-PCM, encoder outputs are muted	
Missing Audio Metadata Program	Selected audio metadata is missing the selected program, encoder outputs are muted	
Missing AC-3 Metadata	Selected audio metadata is missing AC-3 metadata, encoder outputs are muted	
Missing Extended BSI [in RED]	Selected audio metadata is missing Extended BSI, encoder outputs are muted	
Missing Audio Metadata [in RED]	No audio metadata is detected, encoder outputs are muted	

Controls – this section of the panel allows the user to set up the encoder and audio metadata configuration.

Parameter	Values	Default	Notes
Encoder	Dolby Digital Plus Dolby Digital OFF	Dolby Digital	
Test Tone	OFF -18 dBFS -20 dBFS Silence	OFF	
Data Rate	For Dolby Digital: Automatic 384 kbps, Automatic 448 kbps,	For Dolby Digital: Automatic 384 kbps	Data rate selection in the Automatic modes is based on the Coding Mode. See the

	56, 64, 80, 96, 112, 128, 160, 192, 224, 256, 320, 384, 448, 512, 576, 640 kbps For Dolby Digital Plus: Automatic, 32, 40, 48, 56, 64, 72, 80, 88, 96, 104, 112, 120, 128, 144, 160, 176, 192, 200, 208, 216, 224, 232, 240, 248, 256, 272, 288, 304, 320, 336, 352, 368, 384, 400, 448, 512, 576, 640, 704, 768, 832, 896, 960, 1008, 1024 kbps	For Dolby Digital Plus: Automatic	<i>Automatic Data Rate Selection</i> table below. The minimum allowed data rate for Dolby Digital and Dolby Digital Plus encoders depends on the coding mode. If the user-selected data rate is lower, it will be overwritten by the allowed minimum value. See the <i>Minimum Data Rate</i> table below.
Stream Number	0 to 6	0	
Bitstream Format	For Dolby Digital: Dolby D 32-bit, Dolby D 16-bit Ch 1, Dolby D 16-bit Ch 2 For Dolby Digital Plus: Dolby D 32-bit	Dolby D 32-bit	This parameter is not available for Dolby Digital Plus, since there is only one possible value.
Metadata Source	Path 1 to Path 4	Path n	n = the encoder number
Program Select	Program 1 to Program 8	Program 1	
Reversion Mode	Use last valid Metadata Stop Encoding	Use last valid metadata	This parameter indicates how the encoder will behave when the incoming metadata is lost.

In automatic mode here are the data rates used according to the detected coding mode:

Coding Mode	Dolby Digital Encoder		Dolby Digital Plus Encoder
	Automatic 384 kbps	Automatic 448 kbps	Automatic
1/0	96 kbps	96 kbps	64 kbps
2/0	192 kbps	256 kbps	128 kbps
2/1, 2/1L, 3/0, 3/0L	256 kbps	256 kbps	160 kbps
2/2, 2/2L, 3/1, 3/1L	320 kbps	320 kbps	192 kbps
3/2, 3/2L	384 kbps	448 kbps	192 kbps

There is a minimum data rate allowed for each Coding Mode for Dolby Digital and Dolby Digital Plus encoders. If the user-selected data rate is lower than this minimum, it will be overwritten by the minimum allowed value.

Coding Mode	Minimum Value	
	Dolby Digital Encoder	Dolby Digital Plus Encoder
1/0	56 kbps	32 kbps
2/0	96 kbps	64 kbps
2/1, 2/1L, 3/0, 3/0L	160 kbps	128 kbps
2/2, 2/2L, 3/1, 3/1L	192 kbps	160 kbps
3/2, 3/2L	224 kbps	192 kbps

Status – the Status area at the bottom of the panel reports the status of some parameters in the selected Metadata:

Status Topic	Values
Metadata Bitstream	Not present Invalid Valid, does not include AC-3 metadata, Valid with AC-3 metadata, no extended BSI, Valid with AC-3 metadata and extended BSI
Coding Mode	1/0, 2/0, 2/1, 2/1L, 3/0, 3/0L, 2/2, 2/2L, 3/1, 3/1L, 3/2, 3/2L
Data Rate Applied	32 kbps to 1024 kbps
Dialnorm	-31 dBFS to -1 dBFS

5.12 Audio Outputs Panel

Up to 16 audio channels can be embedded in the MAP-3901's 3G/H/SD output. This panel allows the user to select the source audio for each of these channels.

The panel has eight identical tabs, configuring two outputs each.

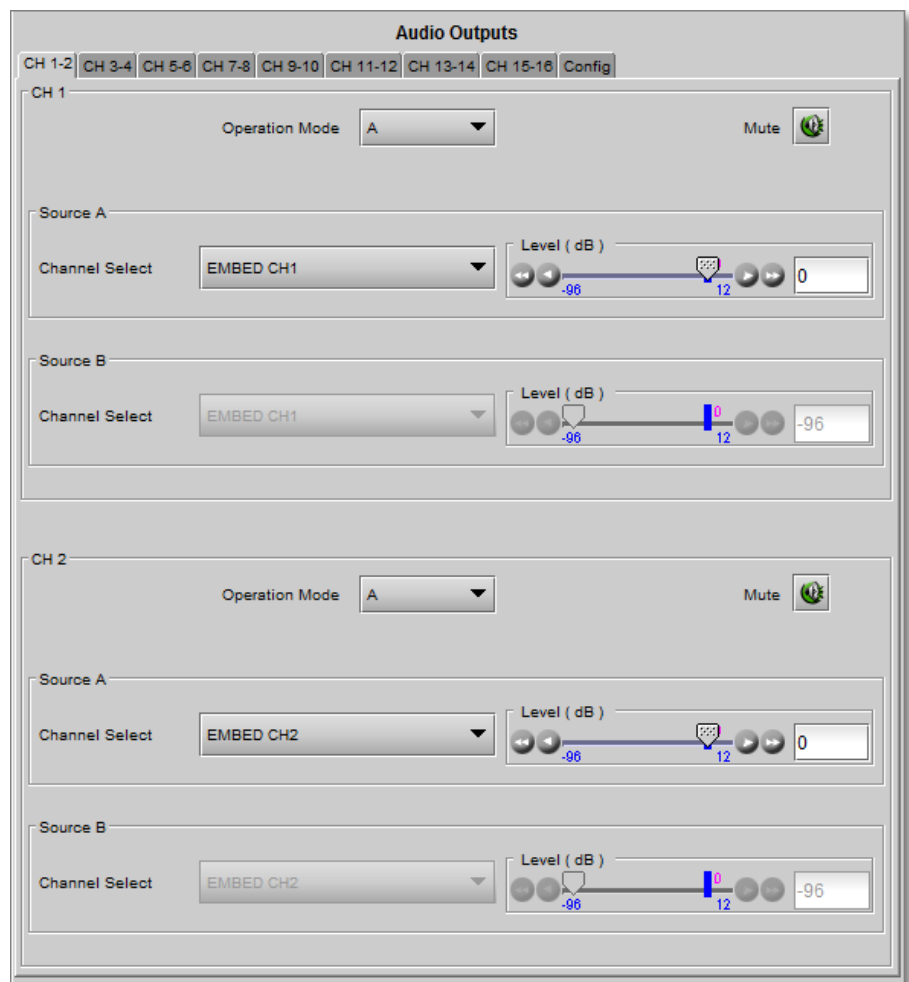

Figure 5-28 Audio Outputs

5.12.1 CH n-m tab

Each channel has separate but identical controls.

If you have selected a non-PCM signal as the input to the channel in the Source pulldown

- It will be flagged in the display.
- Level control will be ignored except for -96dB or if the channel is muted.
- Source B will be muted in the Mix operation mode

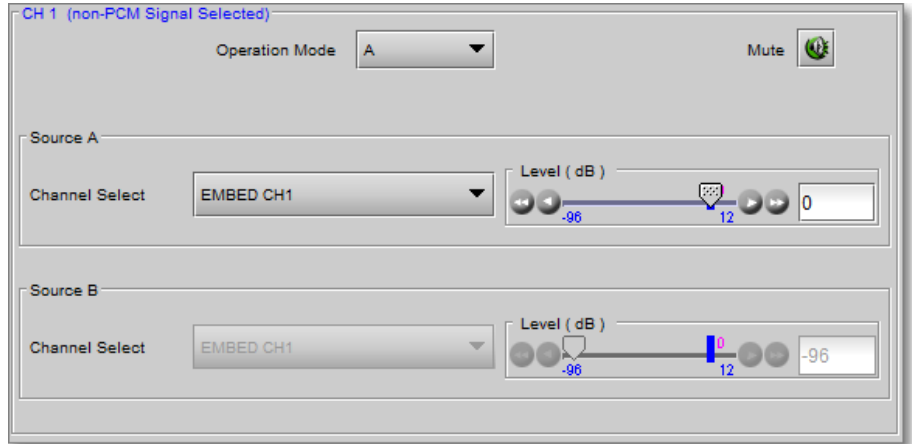

Figure 5-29 Audio Outputs non-PCM warning

CH n-m – use the Operation Mode pulldown to select the channel source:

Operation Mode	Functionality	Default
OFF	The audio output channel is muted (-96 dB)	A
A	The output comes from the source A channel selection The level of source A can be adjusted using the slider	
Mix	The output is a mono mix of the channels selected for source A and source B The level of each source can be adjusted independently.	

Level (dB): Sets the audio gain from -96 to 12 dB in 0.5 dB steps.

Levels values	Default
-96 to 12 dB	0 dB



Note that a channel can be muted, while leaving all other settings untouched, by selecting the Mute button to the right of the Operation Mode pulldown.

Mute Values	Default
ON, OFF	OFF

Channel Select: The sources available on the Channel Select pulldown depend on whether certain options have been activated, as shown here:

Inputs listed on pull-down	Availability / Required options
Embed CH1 to CH16	Always
DMIX 1 - CH1 to CH2	Always
DMIX 2 - CH1 to CH2	Always
DEC DE 1 - CH1 to CH8	MAP-3901-OPT-DED-1 or -DED-2
DEC DE 2 - CH1 to CH8	MAP-3901-OPT-DED-2
UPMIX 1 - CH1 to CH6	MAP-3901-OPT-UPMIX-1 or -UPMIX-2
UPMIX 2 - CH1 to CH6	MAP-3901-OPT-UPMIX-2

ENC DD+ 1 - CH1 to CH2	MAP-3901-OPT-DDE-1 or -DDE-2 or -DDE-3 or -DDE-4
ENC DD+ 2 - CH1 to CH2	MAP-3901-OPT-DDE-2 or -DDE-3 or -DDE-4
ENC DD+ 3 - CH1 to CH2	MAP-3901-OPT-DDE-3 or -DDE-4
ENC DD+ 4 - CH1 to CH2	MAP-3901-OPT-DDE-4

5.12.2 Embedded Audio Config tab

SD Audio Resolution – for SD outputs, the number of bits to be embedded must also be selected, and so the settings in the pull-down are:

Values	Default
20 bits, 24 bits	20 bits

3G/HD/SD SDI Outputs – use the pull-down in this tab to enable (Automatic) or disable (OFF) audio embedding in the output.

- When OFF is selected, no audio is embedded in the HD output.
- When Automatic is selected, only those audio groups containing at least one audio channel will be embedded at the output.

Values	Default
Automatic, OFF	Automatic

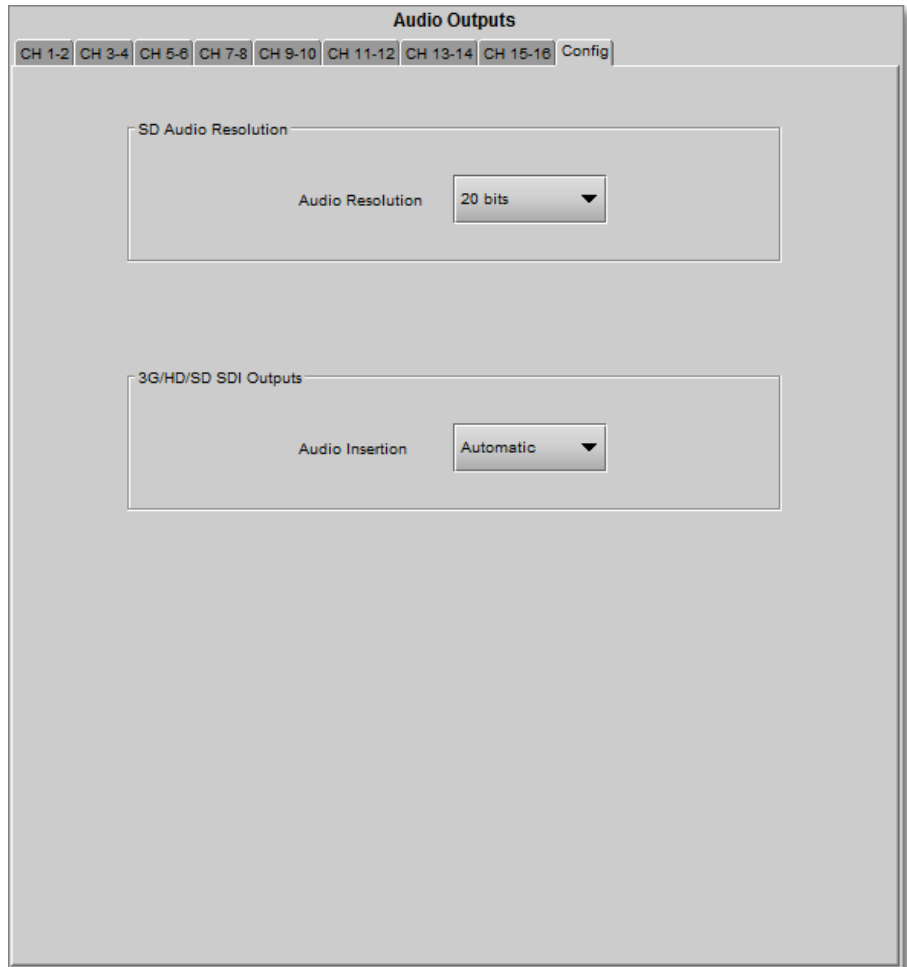



Figure 5-30 Audio Output – Config tab

5.13 Audio Metadata Panel

Up to four VANC metadata streams can be extracted from the incoming video for use in the MAP-3901. Additionally, metadata is available from active decoders.

- The presence icons at the top of the panel are green when valid metadata is present from the indicated source. Otherwise, the presence icons will be greyed out.

Icon	Stream Presence
	Not Present
	Present and valid

- Use the Input/Output tab to configure the metadata extraction.

The MAP-3901 establishes four Metadata paths, individually configured. Each path has its own tab in the Audio Metadata panel. Each path includes:

- A probe, to display parameter values of the selected source.
- A generator, to create internal audio metadata information.

The probe and generator are identified with the path number, so Path 1 includes Probe 1 and Generator 1.

5.13.1 Path n tab

Path n – the four *Path* tabs provide all the resources to configure their associated metadata paths.

The graphic at the top of the tab illustrates the path configuration and current status.

- The green lines indicate the metadata signal flow within the path.
- The pulldowns within the graphic allow the user to configure the path.

Primary: Select the primary Metadata source for the path

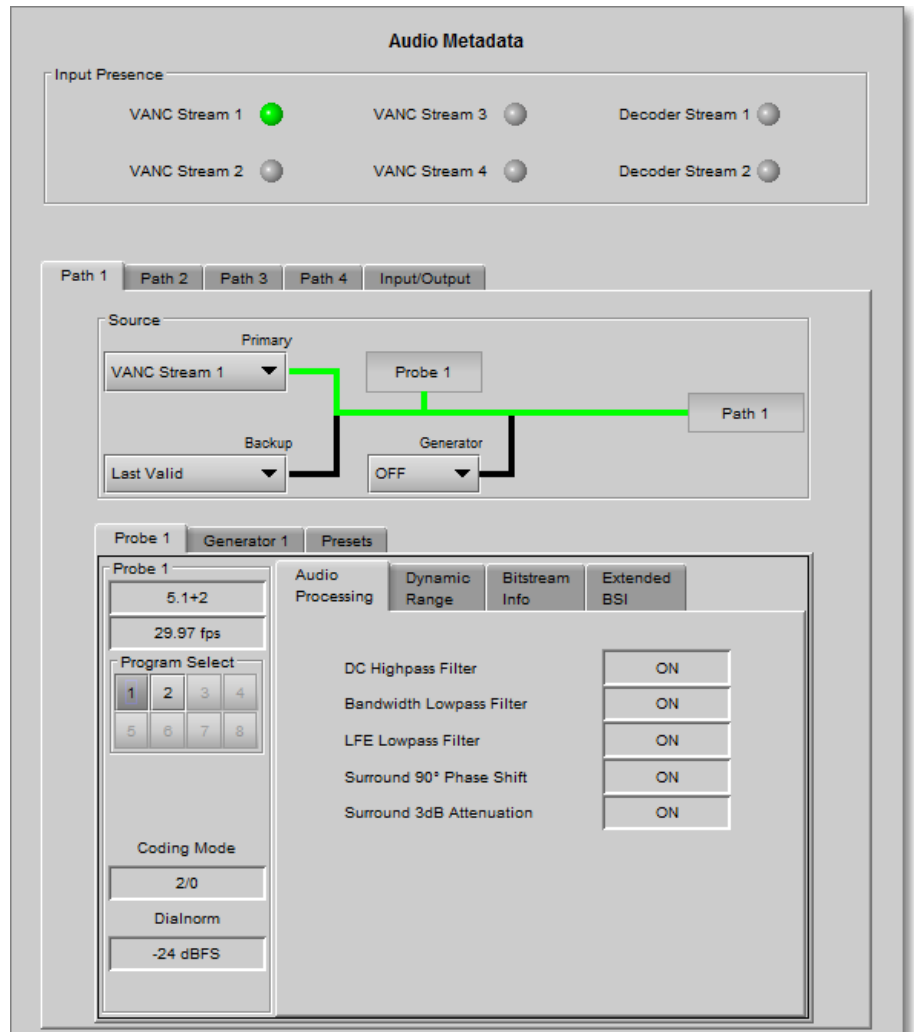

Figure 5-31 Audio Metadata Tabs

Primary Source	Details	Default
VANC Stream 1 to 4	Audio metadata streams from the SDI VANC interval	Path1 = VANC Stream 1 Path1 = VANC Stream 2
Decoder Stream 1 to 2	Audio Metadata stream form decoders	Path1 = VANC Stream 3 Path1 = VANC Stream 4

All streams are selectable, whether or not they are currently present.

- *Except:* Decoder streams are only selectable if the associated decoder option is active:

Source	Required Options
Decoder Stream 1	MAP-3901-OPT-DED-1 or -DED-2
Decoder Stream 2	MAP-3901-OPT-DED-2

Backup: Select the source that will be used if the primary source becomes unavailable. The list is the same as the source list in the Primary pulldown, with the addition of some extra options:

Backup Source	Details	Default
All primary sources	Refer to Primary sources	Last valid
Last valid	Keep the last valid source used.	
Blank	No metadata	
Generator	Active internal generator	

Note: The Backup source can be the same as the primary source.

Generator: Turn the path’s associated generator ON or OFF

Generator	Details	Default
ON	The generator output is forced onto the path output.	OFF
OFF	The path output follows the source/backup. If the generator is the selected backup and the primary source becomes invalid, the generator will become the path output	

The generator is configured in the Generator n tab.

5.13.2 Path n – Probe n tab

The Probe tab displays the metadata parameters for the selected source and program.

- Select the program on the left side
- The Probe tab has no other active controls

See the table in the *Generator n* section for a list of the parameters displayed and possible values.

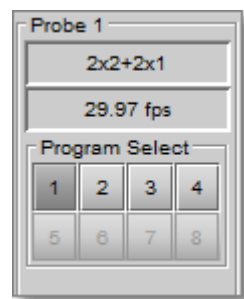

5.13.3 Path n – Generator n tab

This tab provides resources to configure the metadata output of the generator in Path n.

The user first specifies the program configuration, and then uses the pulldowns to set values for all other parameters.

Parameter	Possible Values	Default	Note
Generator n			
Program Configuration	5.1+2, 5.1+ 2x1, 4+4, 4+2x2, 4+2+2x1, 4+4x1, 4x2, 3x2 + 2x1, 2x2+4x1, 2+6x1, 8x1, 5.1, 4+2, 4+2x1, 3x2, 2x2+2x1, 2+4x1, 6x1, 4, 2+2, 2+2x1, 4x1, 7.1, 7.1	5.1	

	Screen		
Program select	[existing programs, up to 8, are enabled]	1	
Coding Mode	1/0, 2/0, 3/0, 3.0L, 2/1, 2/1L, 3/1, 3/1L, 2/2, 2/2L, 3/2, 3/2L	3/2L	
Dialnorm	-31 dBFS to -1 dBFS	-24 dBFS	
Audio Processing tab			
DC Highpass Filter	ON/OFF	ON	
Bandwidth Lowpass Filter	ON/OFF	ON	
LFE Lowpass Filter	ON/OFF	ON	
Surround 90° Phase Shift	ON/OFF	ON	
Surround 3 dB Attenuator	ON/OFF	OFF	
Dynamic Range tab			
Line Mode Profile	None, Film Standard, Film Light, Music Standard, Music Light, Speech	Film Standard	
RF Mode Profile	None, Film Standard, Film Light, Music Standard, Music Light, Speech	Film Standard	
RF Overmod. Protection	ON/OFF	OFF	
Bitstream Info tab			
Bitstream Mode	Complete Main, Music and Effects, Visually Impaired, Hearing Impaired, Dialogue, Commentary, Emergency, Karaoke	Complete Main	
Center Downmix Level	-3.0 dB, -4.5 dB, -6.0 dB	-3.0 dB	
Surr. Downmix Level	-3.0 dB, -6.0 dB, CUT	-3.0 dB	
Dolby Surr. Mode	Not Indicated, Not Dolby Surround Encoded, Dolby surround Encoded	Not Dolby Surround Encoded	
Copyright Bit	Not Indicated as Protected, Indicated as Protected	Indicated as Protected	
Original Bitstream	Not Original Bitstream, Original Bitstream	Original Bitstream	
Audio Production Info.	Information Does Not Exist, Information Exists	Information Does Not Exist	
Mix Level	80 to 111 dB SPL	80 dB SPL	1
Room Type	Not Indicated, Large Room, X Curve Monitor, Small Room, Flat Monitor	Not Indicated	1
Extended BSI tab			
Preferred Stereo Downmix	Not indicated, LtRt Preferred, LoRo Preferred	LtRt Preferred	
Lt/Rt Center Mix Level	+3.0 dB, +1.5 dB, 0.0 dB, -1.5 dB, -3.0 dB, -4.5 dB, -6.0 dB, CUT	-3.0 dB	
Lt/Rt Surround Mix Level	+3.0 dB, +1.5 dB, 0.0 dB, -1.5 dB, -3.0 dB, -4.5 dB, -6.0 dB, CUT	-3.0 dB	
LoRo Center Mix Level	+3.0 dB, +1.5 dB, 0.0 dB, -1.5 dB, -3.0 dB, -4.5 dB, -6.0 dB, CUT	-3.0 dB	
LoRo surround Mix Level	+3.0 dB, +1.5 dB, 0.0 dB, -1.5 dB, -3.0 dB, -4.5 dB, -6.0 dB, CUT	-3.0 dB	
Surround EX mode	Not indicated, Not Surround EX Encoder, Surround EX Encoder	Not Surround EX Encoder	
Converter Type	Standard, HDCD	Standard	

Notes for this table:

1. This parameter is only available when *Audio Production Information Exists* is selected in the Audio Production Info pulldown.

5.13.4 Path n – Presets tab

The MAP-3901 provides the user with eight configurable presets, accessible in each of the four paths.

- Each preset can be loaded with data from the current Path configuration, or from the probe [Save]
- The contents of each preset can be loaded into the generator [Load]

In addition, two factory pre-configured presets are available to be loaded into the generator:

- Factory 5.1
- Factory 2.0

The Current Generator Preset window displays the name of the preset whose contents are loaded into the generator.

- If any values have been changed since the preset was loaded, the window displays “Custom”

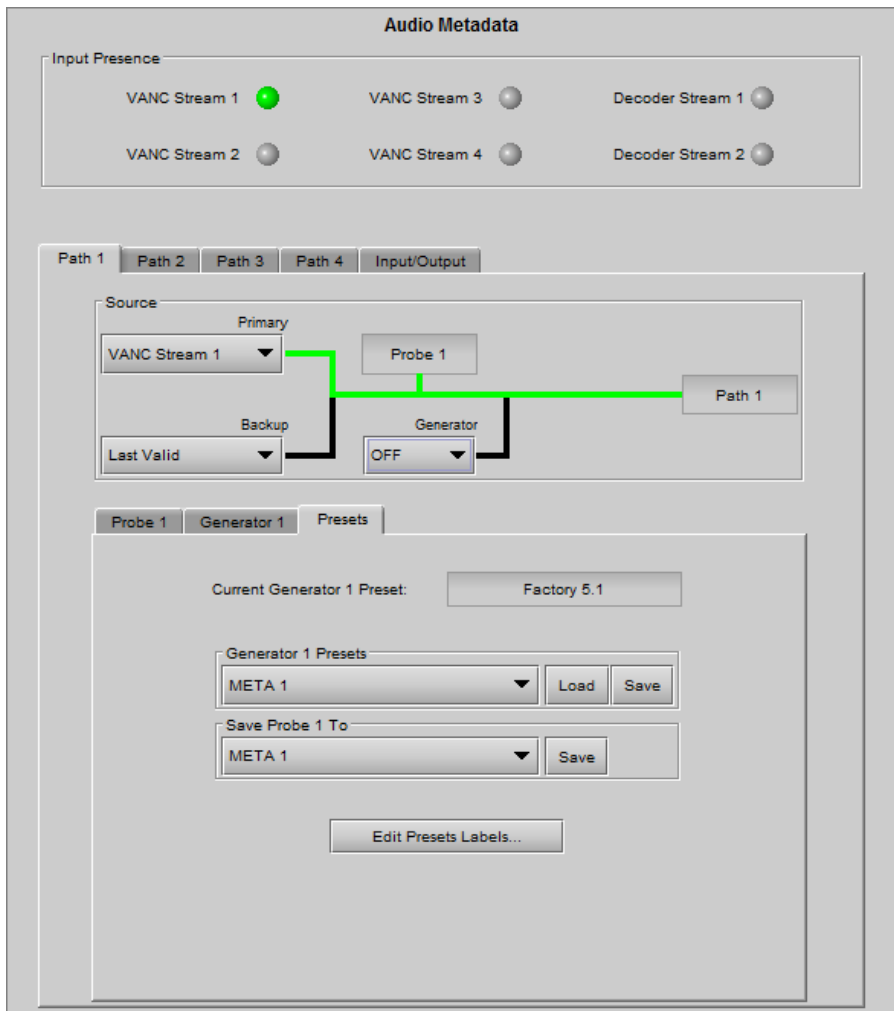

Figure 5-32 Audio Metadata - Presets

Function	Control	Values	Default	Notes
Generator n Presets	Pulldown Selector	META 1 to META 8 Factory 5.1 Factory 2.0	META 1	
	Load (click button)	Load request		1
	Save (click button)	Save request		2, 3
Save Probe n To	Pulldown Selector	META 1 to META 8 Generator 1 to Generator 4	META 1	
	Save (click button)	Save request		4

Notes:

1. When Load is clicked, a warning will pop up to remind the user that he will lose the current generator configuration.
2. When Save is clicked, a warning will pop up to remind the user that he about to overwrite the current contents of the selected preset.
3. Note that the contents of the Factory 5.1 and Factory 2.0 presets cannot be overwritten, so Save is not possible.
4. When Save is clicked, a warning will pop up to remind the user that he is about to replace the current preset or generator settings with the data from the probe.

5.13.5 Input/Output tab

This tab provides controls for Metadata extraction and insertion.

VANC Metadata Extractor – the MAP-3901 can extract four audio metadata streams from the VANC interval. The four pulldowns allow source selection based on the SDID.

When multiple audio programs are carried or associated with a single video signal, the SDID value is used to identify the VANC data packet(s) carrying the audio metadata for each of the audio programs. It specifies the relationship between an SDID value and the first audio channel pair of the audio channel pairs used to carry all of the audio channels required to make up an audio program. Audio channels of an audio program must be carried on consecutive channel pairs because only the first channel pair of a program can to be signaled.

Audio Channel Pair	SDID
No association	01
Channel pair 1/2	02
Channel pair 3/4	03
Channel pair 5/6	04
Channel pair 7/8	05
Channel pair 9/10	06
Channel pair 11/12	07
Channel pair 13/14	08
Channel pair 15/16	09



Figure 5-33 Audio Metadata – Input/Output

VANC Metadata Inserter – the MAP-3901 can insert up to four audio metadata streams into the output video stream. The metadata streams are identified as Path 1 to Path 4, and the contents of those paths are created within the MAP-3901, as described elsewhere in this guide.

The user has three choices to make for inserting each Path, and one common selection for all Paths:

Function	Values	Default Value	Note
Insertion	ON, OFF	OFF	
Insertion Line	3G/HD: Lines 9 to 20 SD (525): Lines 12 to 19 SD (625): Lines 8 to 22	3G/HD: Path 1: Line 10, Path 2: Line 11, Path 3: Line 12, Path 4: Line 13 SD (525): Path 1: Line 12, Path 2: Line 13, Path 3: Line 14, Path 4: Line 15 SD (625): Path 1: Line 8, Path 2: Line 9, Path 3: Line 10, Path 4: Line 11	
SDID	01 to 09	VANC Stream 1 = 01 VANC Stream 2 = 02 VANC Stream 3 = 03 VANC Stream 4 = 04	1
Mapping	Method A, Method B (applies to all four paths)	Method A	2

Notes:

1. Any SDID can be selected only once. The already selected SDID will be in red on the drop box for the other paths. You have to unselect one SDID to be able to select it on another path
2. Refers to the vertical ancillary data mapping of audio metadata as per SMPTE ST 2020-2 (Method A) and SMPTE ST 2020-3 (Method B) standards.

If the card is configured to insert a special SDID at the output, any Dolby Metadata packets at the input with the same SDID will be deleted. Any other SDID packets not inserted by the card will be passed through untouched.

5.14 Test Panel

This panel contains a single checkbox that sends a 75% color bar test pattern (100% white), along with audio test tones (a continuous -18dBFS at 1 KHz tone on right channel with pulsed tone on left channel in every pair) to the MAP-3901 output.

The status icon at the top of the panel changes when the test mode is active.

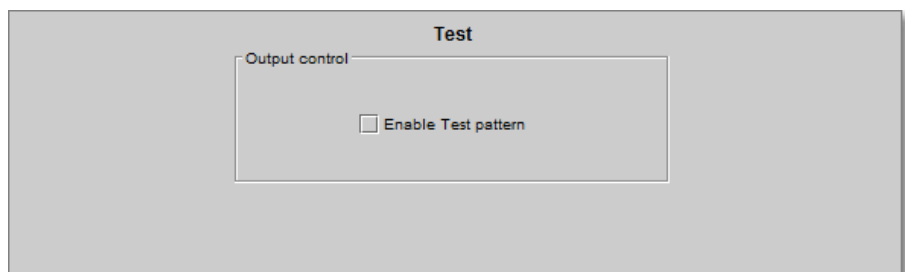

Figure 5-34 Test pattern

Enable Test pattern status is not saved, and always defaults to *Not Enabled* after a power up. This control is here for testing purpose

Note: the card must be referenced to a valid video reference to have a usable test pattern to the MAP-3901 output

5.15 GPIO Panel

The eight GPIO on the MAP-3901 are individually configurable as GPI or GPO.

5.15.1 I/O Config tab

The pulldowns allow each of the eight GPIO to be defined as GPI or GPO.

GPIO #	Values	Default
GPIO 1 – 4:	GPI, GPO	GPI
GPIO 5 – 8:	GPI, GPO	GPO

When changing a GPIO configuration, a warning will pop up to remind the user that he is changing the card IOs

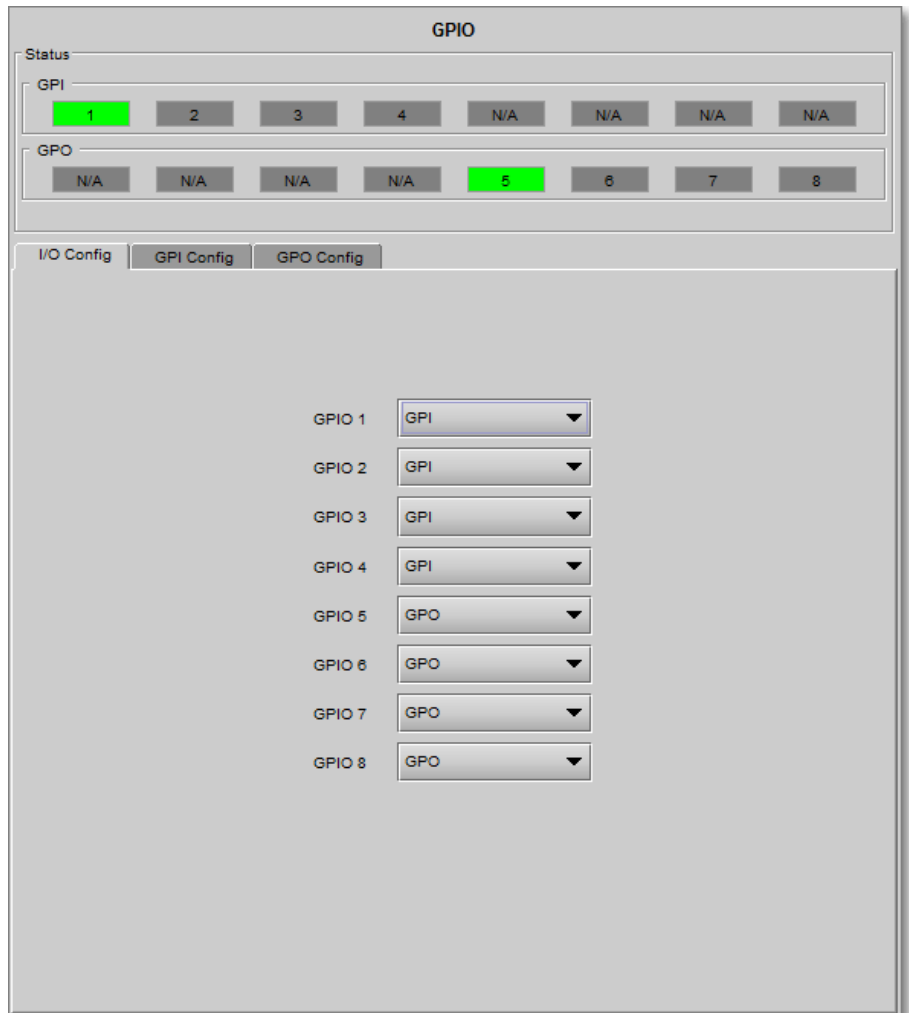

Figure 5-35 GPIO panel – I/O Config tab

5.15.2 GPI Config tab

GPI in the MAP-3901 can trigger actions upon activation and upon release. This panel allows both of these to be set for each active GPI.

Action	Values	Default
On activation (GPI 1 – GPI 8)	Load User Preset 1 ⋮ Load User Preset 20 Nothing	Nothing
On release (GPI 1 – GPI 8)	Load User Preset 1 ⋮ Load User Preset 20 Nothing	Nothing

The GPIs are all contact closures to ground (GND).

- For an activation, simply short the corresponding GPI input pin to any GND pin.
- For a release, stop shorting the corresponding GPI to the GND.

The current state of each GPI is reported by the Status section



Icon	GPI 1 to 8
	Grey Not a GPI (N/A) or no contact to GND
	Green Contact to GND



Figure 5-36 GPIO panel - GPI config tab

Move the mouse over a GPI status and a tool tip appears below the icon providing the action linked to this GPI.

5.15.3 GPO Config tab

GPOs are also contact closure to ground (GND). A low level indicates the GPO is currently active.

GPOs are used to monitor card user presets. When a user preset is activate, the corresponding user preset GPO is also activated. If the card configuration is modified, the GPO will be cleared at the same time.

Action	Values	Default
On activation (GPO 1 – GPO 8)	Current preset is User Preset 1 : : Current preset is User Preset 20 Nothing	Nothing

The current state of each GPO is reported by the Status section

Icon	GPO 1 to 8
Grey	Not a GPO (N/A) or no contact to GND
Green	Contact to GND

Move the mouse over a GPO status and a tool tip appears below the icon showing the behavior linked to this GPO.



Figure 5-37 GPIO Panel - GPO Config tab

5.16 Options Panel

A number of options are available for the MAP-3901:

Option Function	Option Name	Description
Dolby E Decoder	MAP-3901-OPT- DED-1	Single Dolby E decoding option
	MAP-3901-OPT- DED-2	Dual Dolby E decoding option
Upmix	MAP-3901-OPT-UPMIX-1	Single Stereo to 5.1 Surround upmix option
	MAP-3901-OPT-UPMIX-2	Dual Stereo to 5.1 Surround upmix option
Dolby Digital and Digital Plus Encoder	MAP-3901-OPT-DDE-1	Single Dolby Digital Plus encoding option
	MAP-3901-OPT-DDE-2	Dual Dolby Digital Plus encoding option
	MAP-3901-OPT-DDE-3	Triple Dolby Digital Plus encoding option
	MAP-3901-OPT-DDE-4	Quadruple Dolby Digital Plus encoding option

To activate each of these options, you must

- Obtain a license key from Grass Valley.
- Open the tab in the options panel corresponding to the option function.
- Type the license key in the *Enter Key* box.
- Click on **ENABLE OPTION** to enable the option's features.

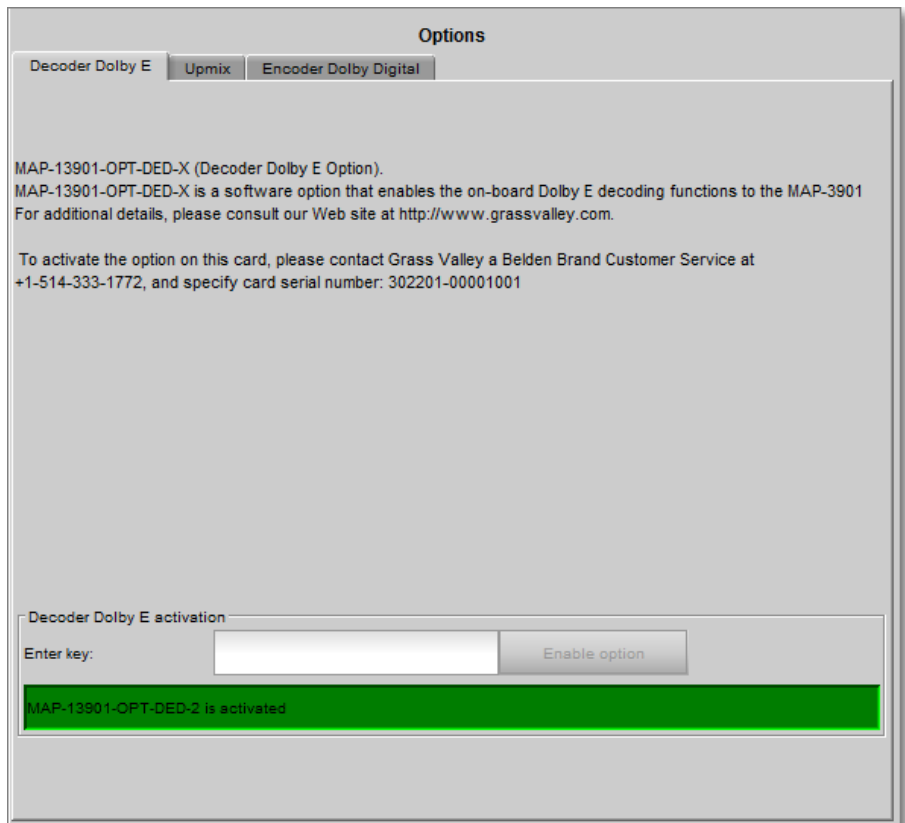

Figure 5-38 Options

5.17 Alarm Config Panel

This panel allows the alarm reporting of the MAP-3901 to be configured. The panel opens in a new window when the button is clicked, and can be resized if needed.

The panel is organized in columns.

Status/Name

This contains an expandable tree listing all the alarms reported by this MAP-3901 card.

- Each alarm name includes an icon that shows its current status
- Some alarms may be text-only and the alarm status is shown in the name and not by a status icon
- The figure shows the entire tree, but some repetitive alarms were removed to reduce the size of the image.

The **Card LED**, **Overall Alarm** and **GSM Contribution** columns contain pulldown lists that allow the level of contribution of each individual alarm to the alarm named in the column heading to be set.

- Click on the alarm icon to see the available levels; then click on one to select it



Card LED

This column allows configuration of the contribution of selected individual alarms to the status LED located on the front card edge. The Card LED status is shown at the bottom of the alarm tree in the Status/Name column.

Overall Alarm

This column allows configuration of the contribution of each individual alarm to the Overall Alarm associated with this card. The Overall Alarm is shown in the upper left corner of the iControl panel, and also appears at the bottom of the Status/Name column.

GSM Contribution

This column allows configuration of the contribution of each individual alarm to the GSM Alarm Status associated with this card. GSM is a dynamic register of all iControl system alarms, and is also an alarm provider for external applications. The possible values for this contribution are related to the Overall alarm contribution:

- If the Overall alarm contribution is selected as Disabled, the GSM alarm contribution can be set to any available value
- If the Overall alarm contribution is selected as any level other than disabled, the GSM contribution is forced to follow the Overall Alarm.

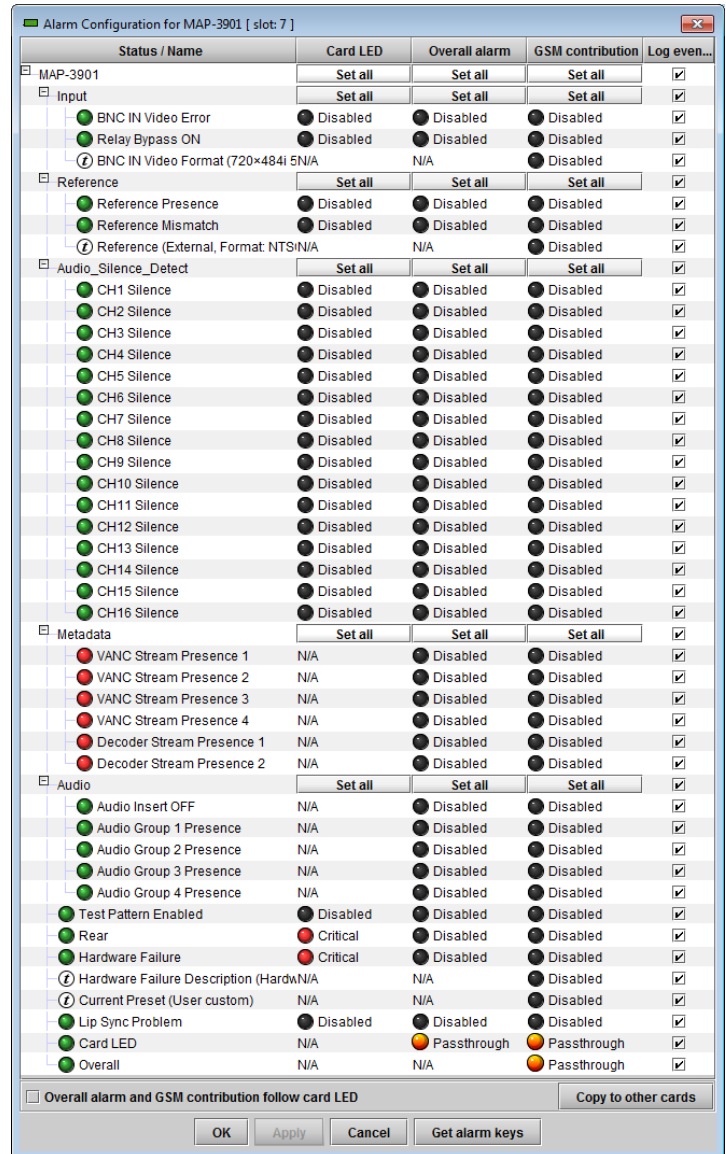







Figure 5-39 Alarm Configuration

Log Events

iControl maintains a log of alarm events associated with the card. The log is useful for troubleshooting and identifying event sequences. Click in the checkbox to enable logging of alarm events for each individual alarm.

Levels associated with these alarms:

The pulldown lists may contain some or all of the following options:

-  Disabled The alarm makes no contribution (black icon)
-  Minor The alarm is of minor importance (yellow icon)
-  Major The alarm is of major importance (orange icon)
-  Critical The alarm is of critical importance (red icon)
-  Passthrough The alarm exists but has no effect (used for text and composite alarms)

Shortcut: if you click in one of the Set All boxes beside a section heading, you will open a pulldown that lets you assign a level to all alarms in that section of the column simultaneously.

Once the alarms are configured, you may accept the changes or discard them:

Overall alarm and GSM contribution follow card LED

Click in the checkbox to force the Overall alarm and GSM contribution to be identical to the Card LED status

- All Overall alarms and GSM contributions for which there is a Card LED alarm will be forced to match the Card LED alarm
- All Overall Alarms and GSM contributions for which there is no Card LED alarm will be forced to Disabled

A warning box will open allowing you to confirm the action, since it will result in changes to the configuration and there is no *undo* function.

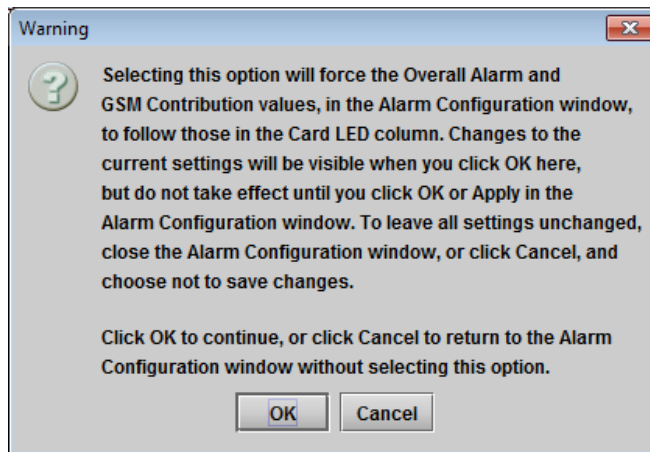

Figure 5-40 Warning for Follow LED change

Copy to other cards

Click this button to open a panel that allows the alarm configuration set for this card to be copied into another MAP-3901 card.

- Select one or more destination cards from the list in the window by clicking in the checkboxes, or all of them by clicking in the *All* checkbox
- Note that when you do a [Copy Profile](#) for this card (see section 5.14), the alarm configuration is copied along with all the other settings.

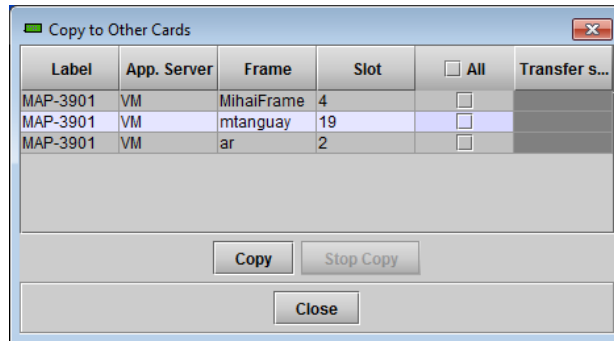

Figure 5-41 Copy to Other Cards window

Get alarm keys

Click this button to open a save dialog where you can save a file containing a list of all alarms on this card and their current values, along with an Alarm Key for each. The alarm keys are useful for system integration and troubleshooting.

- The file is saved in .csv format

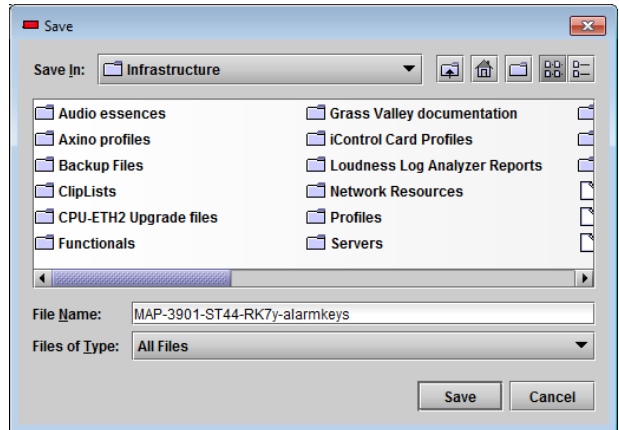

Figure 5-42 Get Alarm Keys dialog

OK, Apply, Cancel

- **OK** accepts the settings and closes the window once the card confirms that there are no errors.
- **Apply** accepts the settings, but leaves the window open
- **Cancel** closes the window without applying any changes, and leaves the previous settings intact.

5.18 Info Panel

When the MAP-3901 is included in an iControl environment, certain information about the card should be available to the iControl system. The user can enter labels and comments that will make this card easy to identify in a complex setup. This information is entered into data boxes in the Info control panel.

Label: Type the label that is shown for this MAP-3901 when it appears in iControl applications

Short Label Type the short-form label that iControl uses in some cases (8 characters)

Source ID Type a descriptive name for this MAP-3901

Comments: Type any desired text

The remaining data boxes show manufacturing information about this card.

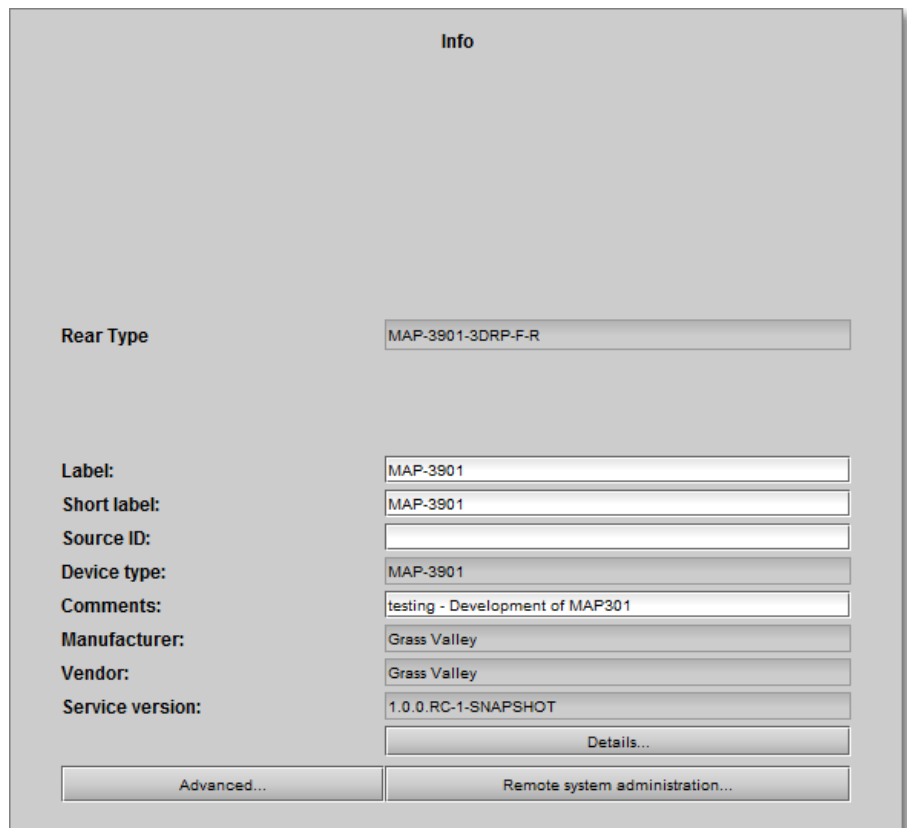

Figure 5-43 Info Panel

Three buttons in the panel give access to other information.

- Details...: Reports the Firmware version, service version, and panel version for this card

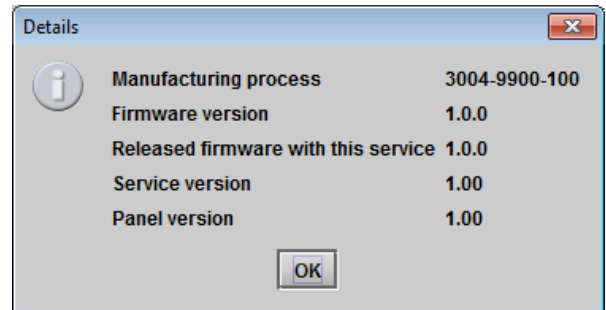

Figure 5-44 Details window

- Advanced...: Shows the Long ID for this card. The Long ID is the address of this MAP-3901 in the iControl network.

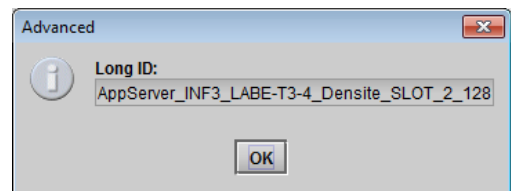

Figure 5-45 Advanced window

- Remote System Administration – opens the Joining Locators window, which lists remote lookup services to which this MAP-3901 is registered

Add: Force the iControl service for this MAP-3901 to register itself on a user-specified Jini lookup service, using the following syntax in the data box:

jini://<ip_address>

where <ip_address> is the ip address of the server running the lookup service, e.g.:

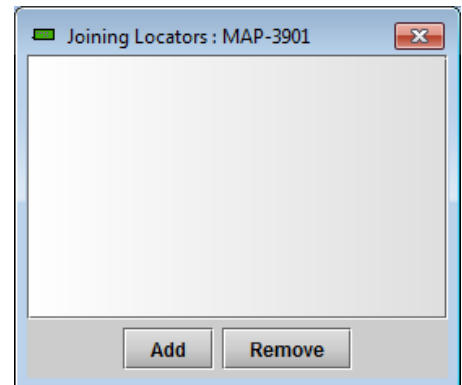
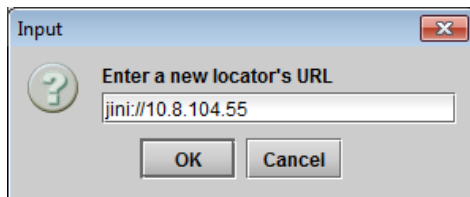
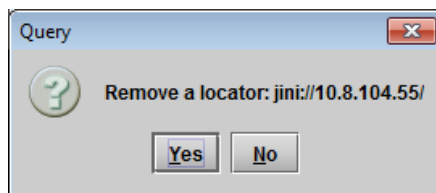

Figure 5-46 Joining Locators window

Remove: select one of the services listed in the window by clicking on it, and click *Remove* to open a query box allowing you to delete it from the window.



5.19 Factory/Presets Panel

5.19.1 Card Presets

The MAP-3901 has memory registers which can hold up to 20 user-defined parameter settings.

Note: GPIO configurations are not included in the presets.

The *Current Preset* box (at the bottom left corner of the panel) displays the last loaded preset.

- Any change to the card configuration after a preset is loaded will change the display to "Custom" instead of the preset value.

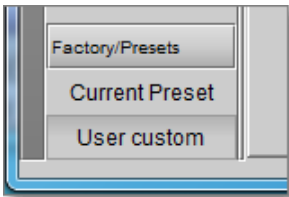

Select any one of the twenty presets using the pull-down list.

Click **Load** to load the contents of the selected User Preset into the MAP-3901. All parameter settings and values will be replaced by the contents of the selected User Preset.

A confirmation box will pop up to allow you to proceed or cancel the load.

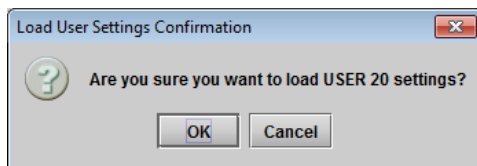

Click **Save** to store the current parameter settings and values from the MAP-3901 into the selected User Preset. The existing contents of the preset will be overwritten. A confirmation box will pop up to allow you to proceed or cancel the save.

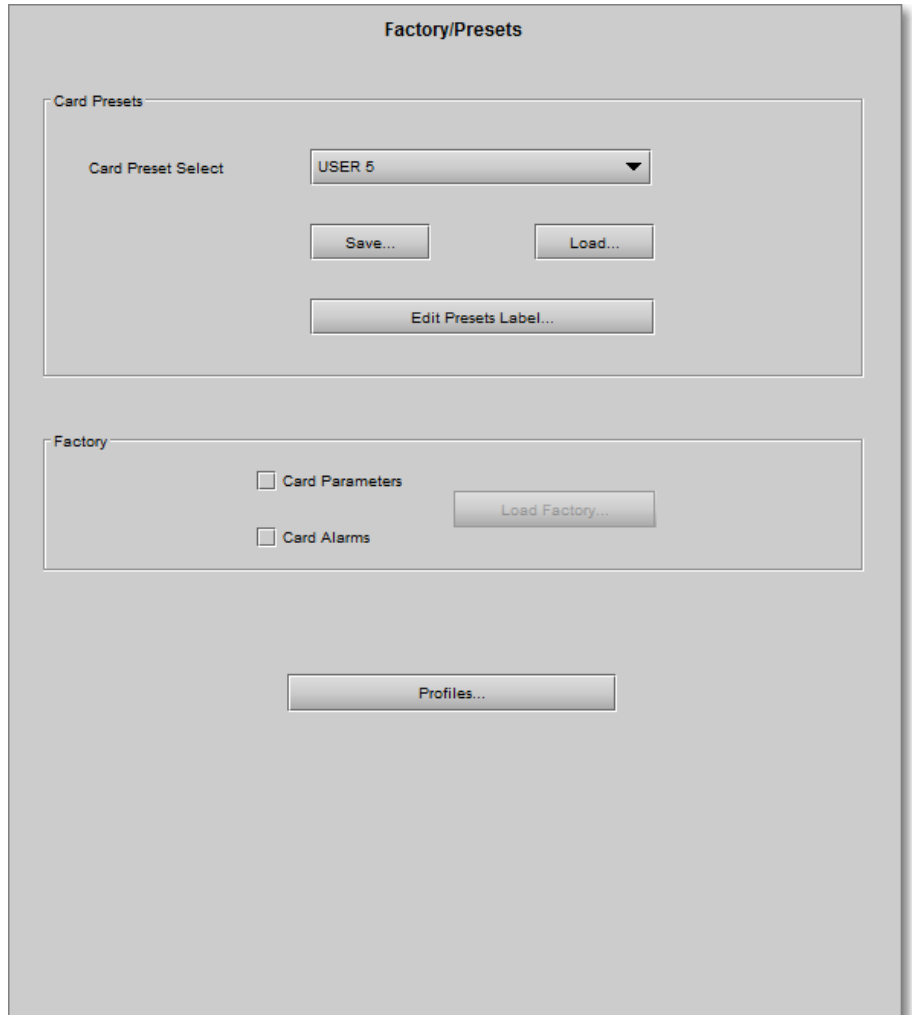
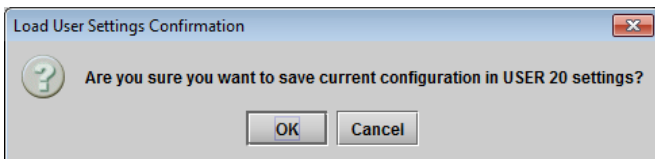
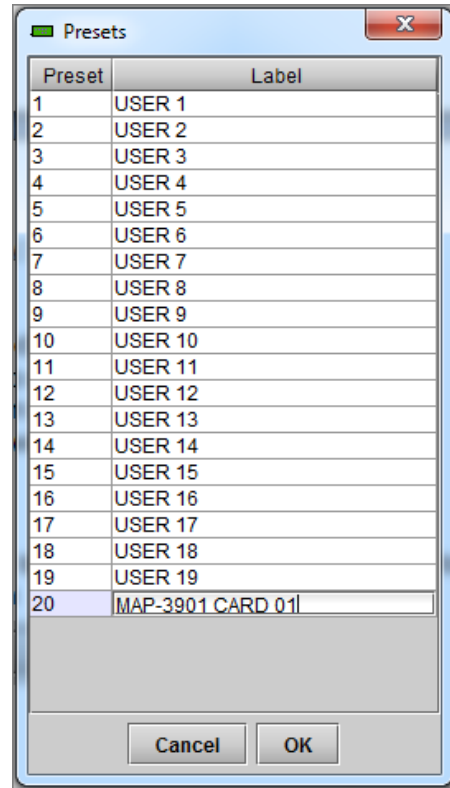
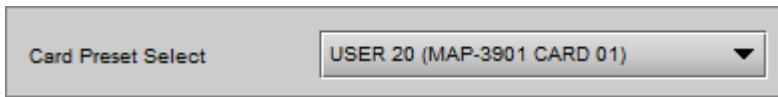

Figure 5-47 Factory/Presets Panel

You can edit the name assigned to each user preset.

- Click Edit Presets Label to open the Presets window.
- Double-click on a name in the Label column
- Type a new name in the window.
- Click OK

The text you have entered (up to 16 characters) will be appended to the label name in the selection pulldown



5.19.2 Factory

Clicking the Load Factory button will restore the card to a factory default state, including GPIO settings. Two checkboxes enable the user to choose whether to include Parameters and/or Alarms in the restoration process

Note: that Card Presets are not changed.

5.19.3 Profiles

Use *Profiles* to save or recover the entire card configuration (including user presets if desired) on an external disk, or to copy it to another MAP-3901 card.

Click on *Profiles* to open the Profile Copy window.

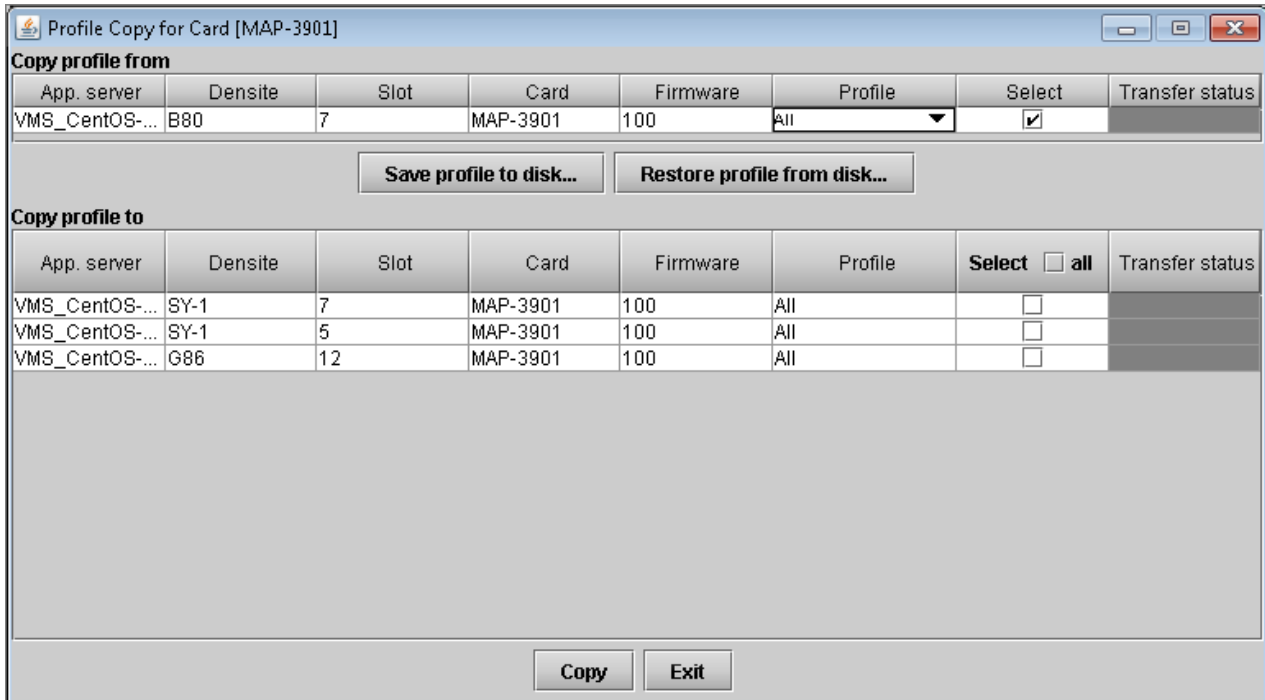

Figure 5-48 Profile Copy for Card

Copy profile from

This line shows this MAP-3901 card, and identifies it by App server, Densité frame and slot number, card type and firmware version.

The *Profile* column has a pulldown that allows you to select which profiles you will work with, and gives these choices:

- Current, User1, User2, User3, ..., User20, All

The *Select* column includes a checkbox (preselected checked) to confirm that you want to work with the current card.

Save Profile to Disk...

After selecting which profiles you want to save, click this button to open a Save dialog allowing you to specify a file name and location to which the selected profiles for this card will be saved.

Hint - It is a good idea to create a folder for these files, because they are not explicitly identified as MAP-3901 profiles, and will be difficult to find and identify if not clearly named and conveniently located.

- Click the save button once the name and location have been identified in the Save box

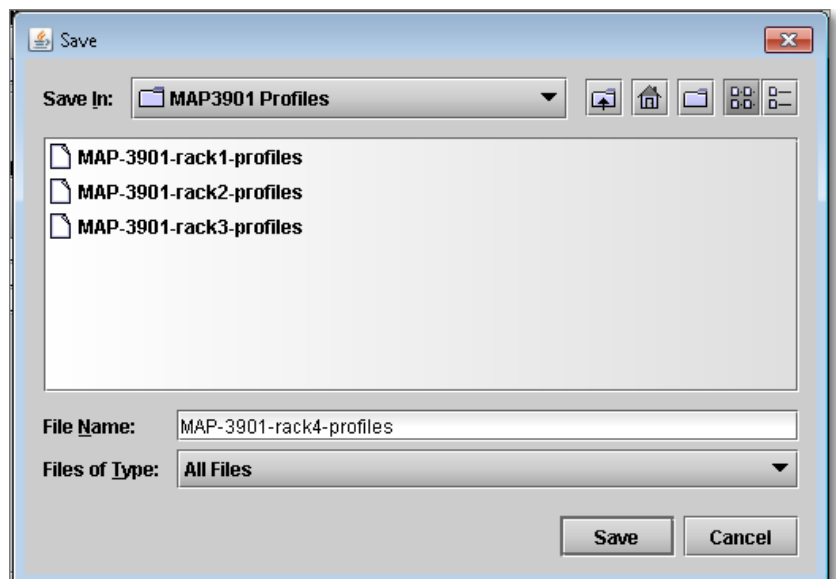
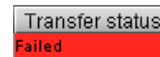
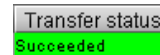

Figure 5-49 Save Profile to Disk dialog

- If the file is saved correctly, the Transfer Status box on the right of the *Copy profile from* line will indicate *Succeeded* against a green background
- If the file was not saved for some reason, the Transfer Status box to the right of the *Copy profile from* line will indicate *Failed* against a red background



Profile	Values	Default
ALL	Current configuration of the card and all presets will be saved on disk	ALL
Current	Only the current configuration of the card is saved on disk	
User1 ...User20	Only the selected preset will be saved on disk	

Restore profile from disk...

Click this button to open an *Open* dialog box within which you can locate and select a valid MAP-3901 profile file.

- Click Open to read the contents of the file and to reconfigure this MAP-3901's profiles according to its contents
- While the reconfiguration is in progress, the Transfer Status box on the right of the *Copy profile from* line will indicate *Working* against a yellow background
- When the reconfiguration is complete, the Transfer Status box on the right of the *Copy profile from* line will indicate *Succeeded* against a green background

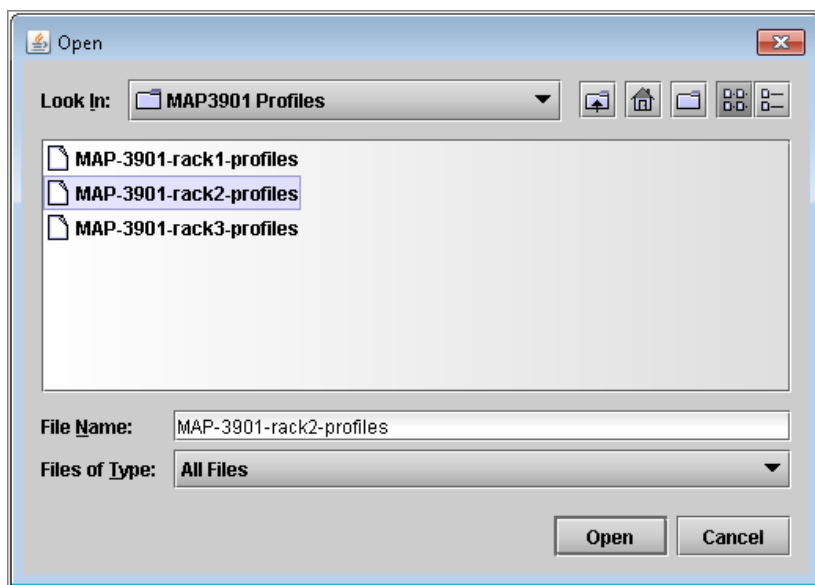

Figure 5-50 Restore Profiles from Disk dialog

On a restore profile from disk, there is no need to select a profile type (ALL, Current, User1 to User20). All the profile contents will be restored.

Note: GPIO configurations are not included in the profiles.

Copy profile to

This section shows other MAP-3901 cards that are available on the iControl network, each identified by App server, Densité frame and slot number, card type and firmware version.

The *Profile* column shows the same information as is shown for the current card in the *Copy profile from* line, i.e. one of the following:

- Current, User1, User2, User3, ..., User20, All

The *Select* column includes a checkbox to identify which MAP-3901 cards you wish to copy profiles into from the current card.

- For convenience, a *Select all* checkbox is provided in the column header

Click *Copy* to copy the selected profiles from this card into the selected other MAP-3901 cards

- While the profile copy operation is in progress, the Transfer Status box on the right of the *Copy profile to* line will indicate *Working* against a yellow background
- When the profile copy operation is complete, the Transfer Status box on the right of the *Copy profile to* line will indicate *Succeeded* against a green background

6 Specifications

Video inputs

SIGNAL	SMPTE 259M-C (270Mbps) and SMPTE 292M (1.485, 1.485/1.001 Gbps) SMPTE 424M (2.970, 2.970/1.001 Gbps)
SUPPORTED FORMATS	SD: 480i59.94, 576i50 HD: SMPTE 274M: 1080i59.94, 1080i50 HD: SMPTE 296M: 720p59.94, 720p50 3G: SMPTE 425 Level A (mapping 1), Level B: 1080p59.94, 1080p50 (Dual Link)
EMBEDDED AUDIO	SMPTE 299M (HD), SMPTE 272 (SD)
CABLE LENGTH ¹	350 m Belden 1694A at 270 Mbps 180 m Belden 1694A at 1.485 Gbps 100 m Belden 1694A at 2.970 Gbps
RETURN LOSS ²	> 10 dB up to 1.5 GHz, > 8 dB up to 3 GHz
CONNECTOR	BNC, DIN

¹Performance may be reduced in bypass mode

²Input protected by relay

Video outputs

SIGNAL	SMPTE 259M-C (270Mbps) and SMPTE 292M (1.485, 1.485/1.001 Gbps) SMPTE 424M (2.970, 2.970/1.001 Gbps)
SUPPORTED FORMATS	SD: 480i59.94, 576i50 HD: SMPTE 274M: 1080i59.94, 1080i50 HD: SMPTE 296M: 720p59.94, 720p50 HD: SMPTE 425 Level A (mapping 1), Level B: 1080p59.94, 1080p50
RETURN LOSS	> 8 dB up 1.5 GHz (OUT 1) > 8 dB up 3 GHz (OUT 1) > 15 dB up 1.5 GHz (OUT 2) > 10 dB up 3 GHz (OUT 2)
JITTER	SD/HD: < 0.2 UI (alignment jitter) as per SMPTE spec 3G: < 0.4 UI (alignment jitter) as per SMPTE spec
CONNECTOR	BNC, DIN

¹Input protected by relay

Video Processing Performance

SIGNAL PATH	10 bits minimum
PROCESSING DELAY	1 interlaced frame (33ms/40ms)

ADDITIONAL VIDEO DELAY up to 124 interlaced frames (33ms/40ms) for SD/HD
up to 62 interlaced frames (33ms/40ms) for 3G

Reference Input

SIGNAL SMPTE 170M/SMPTE 318M/ITU 624-4 black burst
SMPTE 274M/SMPTE 296M Tri-Level Sync

RETURN LOSS > 27 dB up to 5.75 MHz

CONNECTOR BNC, DIN

Audio processing performance

QUANTIZATION 24 bits

SAMPLING 48 KHz, synchronous

NUMBER OF CHANNELS 56 channels

FREQUENCY RESPONSE ± 0.02 dB (20 Hz to 20 KHz)

SNR 123 dB (A weighted)

THD + N -138 dB (20 Hz to 20 KHz)

GPI inputs (up to 8)

SIGNAL Opto-isolated, common ground

VOLTAGE 0V to 7V max

CONNECTOR DE15

GPI outputs (up to 8)

SIGNAL Opto-isolated, common ground

VOLTAGE -5V to 24V max

CURRENT 60mA max

CONNECTOR DE15

Test Pattern generator

VIDEO 100% white bar with 75% color

AUDIO -18dBfs Left channel: pulsed 1 KHz tone
Right channel: steady 1 KHz tone

Miscellaneous

POWER

25W

PHYSICAL FORMAT

Densité 3RU size

7 Contact Us

Grass Valley Technical Support

For technical assistance, contact our international support center, at 1-800-547-8949 (US and Canada) or +1 530 478 4148.

To obtain a local phone number for the support center nearest you, please consult the *Contact Us* section of Grass Valley's website (www.grassvalley.com).

An online form for e-mail contact is also available from the website.

Corporate Head Office

Grass Valley
3499 Douglas-B.-Floreani
St-Laurent, Quebec H4S 2C6
Canada

Telephone: +1 514 333 1772

Fax: +1 514 333 9828

www.grassvalley.com