



grass valley

A **BELDEN** BRAND

SME-1901

SME-1911

Monitoring Streaming Media Encoders

Guide to Installation and Operation

M935-9900-130

2016-01-21

www.grassvalley.com

Electromagnetic Compatibility



This equipment has been tested for verification of compliance with FCC Part 15, Subpart B requirements for Class A digital devices.

NOTE: This equipment has been tested and found to comply with the limits for a Class A digital device, pursuant to part 15 of the FCC Rules. These limits are designed to provide reasonable protection against harmful interference when the equipment is operated in a commercial environment. This equipment generates, uses, and can radiate radio frequency energy and, if not installed and used in accordance with the instruction manual, may cause harmful interference to radio communications. Operation of this equipment in a residential area is likely to cause harmful interference in which case the user will be required to correct the interference at his own expense.



This equipment has been tested and found to comply with the requirements of the EMC directive 2004/108/CE:

- EN 55022 Class A radiated and conducted emissions
- EN 55024 Immunity of Information Technology Equipment
- EN 61000-3-2 Harmonic current injection
- EN 61000-3-3 Limitation of voltage changes, voltage fluctuations and flicker
- EN 61000-4-2 Electrostatic discharge immunity
- EN 61000-4-3 Radiated electromagnetic field immunity – radio frequencies
- EN 61000-4-4 Electrical fast transient immunity
- EN 61000-4-5 Surge immunity
- EN 61000-4-11 Voltage dips, short interruptions and voltage variations immunity

Table of Contents

1	SME-1901 and SME-1911 Monitoring Streaming Media Encoders	1
1.1	Introduction	1
1.2	Features	1
1.3	Functional Block Diagrams	2
1.4	Front Card-edge Interface	3
2	Installation	4
2.1	Installation of Rear Connector Panels	4
2.2	Card Installation	5
2.3	Rear Panels and Connectors	5
2.3.1	Images of rear connector panels	5
2.3.2	Rear Panel Signal Connections	6
3	User Interface	7
3.1	Control options	7
3.2	Card-Edge Status LED	7
4	Local control using the Densité frame control panel	8
4.1	Overview	8
4.2	Menu for local control	8
5	Remote control using iControl	9
5.1	The iControl graphic interface window	9
5.2	Status and Input panel	12
5.3	Video Metadata panel	13
5.4	Dolby Metadata panel	13
5.5	Audio Processing panel	14
5.6	Codec Config panel	16
5.7	Streaming panel	18
5.8	Network Settings panel	19
5.9	Factory/Presets panel	20
5.10	Alarm Config panel	23
5.11	Info panel	25
6	Specifications	27
7	Contact Us	28
	Grass Valley Technical Support	28
	Corporate Head Office	28
	ANNEX 1 – SME-1901/1911 Local User Interface	29
	ANNEX 2 – Upgrading the SME-1901 / SME-1911	31

1 SME-1901 and SME-1911 Monitoring Streaming Media Encoders

1.1 Introduction

Designed for multi-format video/audio over IP in television facilities, the SME-1901 and SME-1911 are compact H.264 streaming encoders with 3G/HD/SD SDI input and optional Fiber connectivity; the SME-1901 also incorporates a 1x6 SDI distribution amplifier.

Two High Profile H.264 streams are generated simultaneously from the SDI input. The Main high resolution stream is ideal for in-house IPTV applications while the low resolution Proxy targets streaming and display within a control system network. Both streams are full frame rate and provide high efficiency compression.

It operates with a wide range of decoders, and offers exceptional space and power efficiency with up to 20 dual stream encoders in a Densité 3 frame configuration. The SME-1901/SME-1911 are ideal for monitoring of core routers over IP, with the SME-1901 also providing “fan-in” and “fan-out” distribution amplification.

1.2 Features

- Space and power efficient design offers up to 20 streaming encoders per frame (in Densité 3).
- High quality SDI distribution amplifier with up to six 3Gbps/HD/SD outputs (SME-1901).
- Highly robust performance with bypass relay protection (available with –R rears on SME-1901).
- Integrated fiber I/O using optional SFP module (available with –F rears).
- Audio encoding of two channels AAC-LC or MPEG 1 layer II.
- Dolby Digital passed to the streaming output
- Effective management of embedded audio with:
 - Selection of 2 channels out of 16 for encoding.
 - Selection of 5.1 channels for downmix and encoding.
- Comprehensive metadata probing includes time code, closed caption (608, 708), teletext, AFD, and WSS.
- H.264 high profile video encoding up to level 4.0 for optimized monitoring.
- Full frame-rate encoding, with encoded resolutions from 128x96 up to 1080i/59.94/50, including 720p/59.94/50 standards.
- Flexible bandwidth management using fixed presets with bit rates from 128 kbps up to 8 Mbps.
- Dual resolution streaming allows simultaneous output of lower-quality proxy plus high-quality stream.
- Operates with wide range of decoders, including STBs, PC clients and Grass Valley’s iControl facility monitoring and Kaleido IP multiviewers.
- Supports streaming of MPEG-TS over Unicast or Multicast using RTP/UDP.

1.3 Functional Block Diagrams

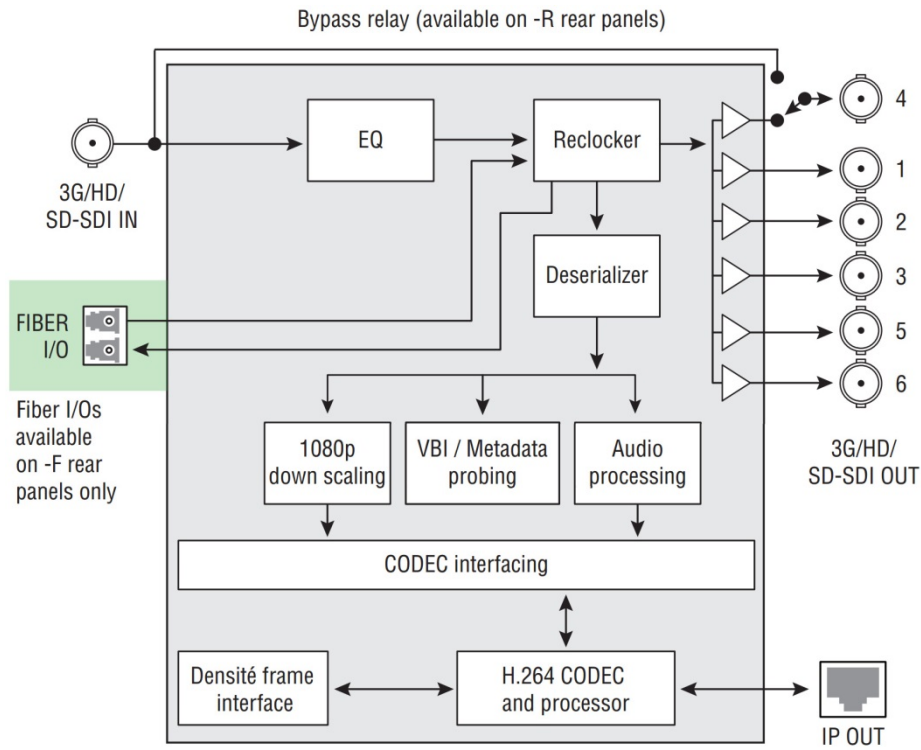

Figure 1.1 SME-1901 Functional Block Diagram

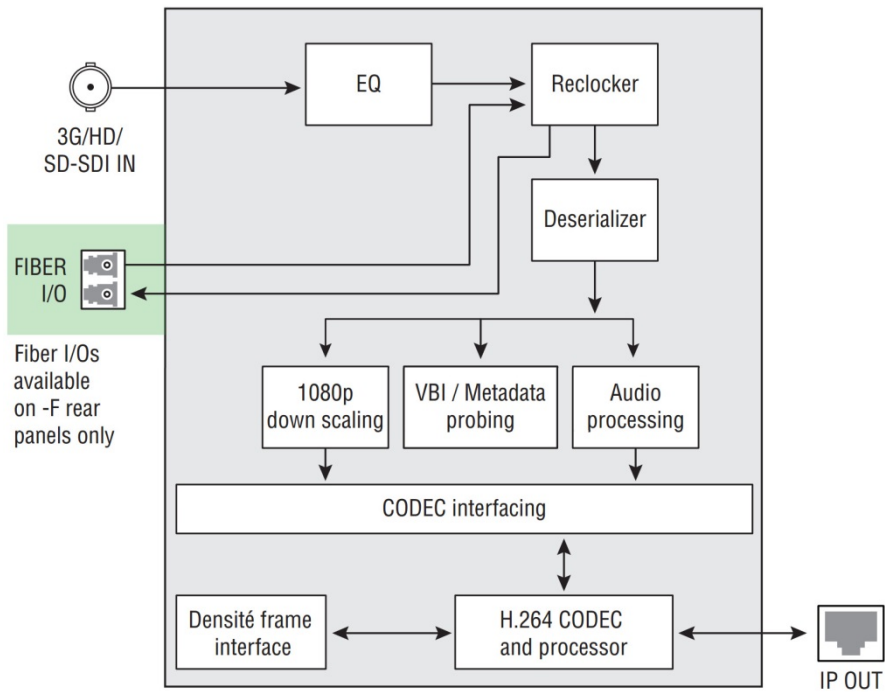

Figure 1.2 SME-1911 Functional Block Diagram

1.4 Front Card-edge Interface

The front card-edge of the SME-1901/1911 incorporates two elements:

- Status LED (see section 3.2)
- Select Button (see section 4)

The card extraction lever indicates the type of card that is installed (SME-1901 shown).

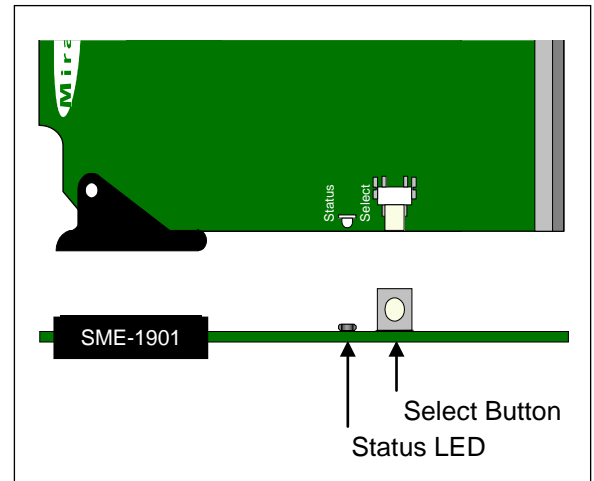

Figure 1.3 Front card-edge layout

2 Installation

2.1 Installation of Rear Connector Panels

Grass Valley Densité-series cards are each associated with a rear connector panel, which must be installed in the Densité frame before the card can be inserted.

The SME-1901/1911 card is sized to fit into Grass Valley's Densité-2 frame, but can be ordered with an extender to fit the taller Densité-3 frame. Rear panels are available for each frame type. SME-1901 and SME-1911 cards use different rear panels, as the SME-1901 rears include the DA outputs and optional bypass relay which are not included in the SME-1911.

SME-1901 rear connector panels:

- SME-1901-DRP Densité-2 - Double-slot-width panel with 1x6 DA
- SME-1901-3SRP Densité-3 - Single-slot-width panel with 1x5 DA
- SME-1901-3SRP-R Densité-3 - Single-slot-width panel with 1x5 DA and bypass relay
- SME-1901-3SRP-F Densité-3 - Single-slot-width panel with 1x4 DA and fiber I/O support
- SME-1901-3SRP-D-F Densité-3 - Single-slot-width panel with 1x6 DA, DIN connectors and fiber I/O support

SME-1911 rear connector panels:

- SME-1911-DRP Densité-2 - Double-slot-width panel
- SME-1911-3SRP Densité-3 - Single-slot-width panel
- SME-1911-3SRP-F Densité-3 - Single-slot-width panel with fiber I/O support

See section 2.3 for details of the signal connections available on each of these connector panel types.

Rear panels are not interchangeable between the SME-1901 and the SME-1911

All cards and rear panels can be installed with the frame power on. The card has connectors which plug into a mid-frame mother board for distribution of power and for connection to the controller card, and a second connector which plugs directly into the rear connector panel for input and output.

The rear connector panel must be installed with the card out of the frame.

- To remove an existing card from the slot, tilt up the swivel handle on the front of the card to lever the connectors apart, then use the handle to pull the card straight out of the slot.

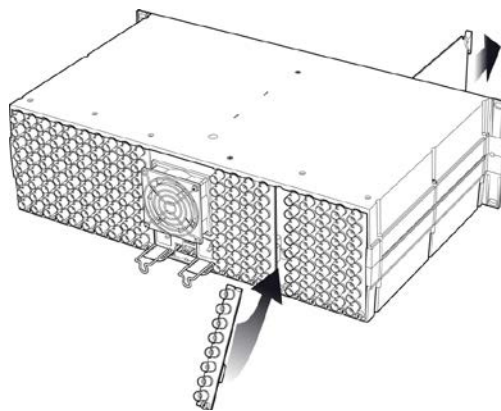

Figure 2.1 Densité-3 frame – rear panel installation

To install the connector panel (Densité 2 and Densité 3 frames):

1. If a card is installed in the slot whose rear panel is being changed, remove it as described above.
2. Remove the existing panel (either blank or belonging to an existing card that is being changed) by releasing the captive screw(s) at the bottom.
3. Position the new panel and secure it in place with the captive screw(s) at the bottom.

2.2 Card Installation

Once a matching rear connector panel has been installed, install the SME-1901/1911 card as follows:

1. Open the front panel of the frame.
2. Slide the SME-1901/1911 card into the slot and push gently on the handle to seat the connectors.
 - For the double-slot-width rear panels used in Densité 2 frames, insert the card into the right-most slot, as seen from the front of the frame. If the card is inserted into the wrong slot, the status LED on the front of the card will flash red. The card will not be damaged.
3. Close the front panel of the frame.

2.3 Rear Panels and Connectors

2.3.1 Images of rear connector panels

The available rear panels for the SME-1901 and the SME-1911 are shown in the figures below, and their various inputs and outputs are described.

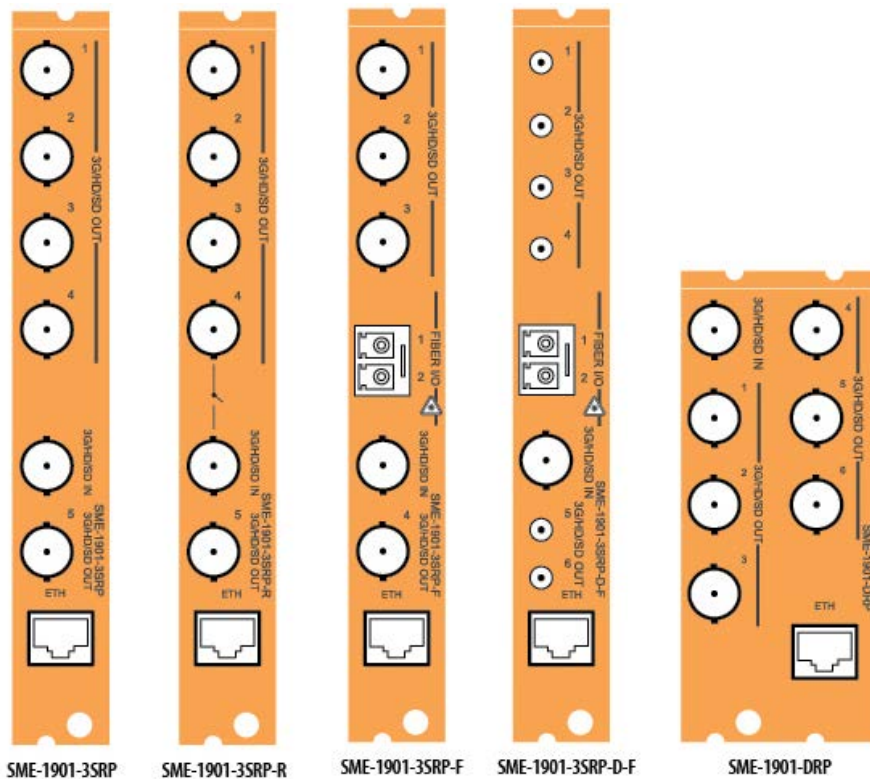

Figure 2.1 SME-1901 Rear Panels

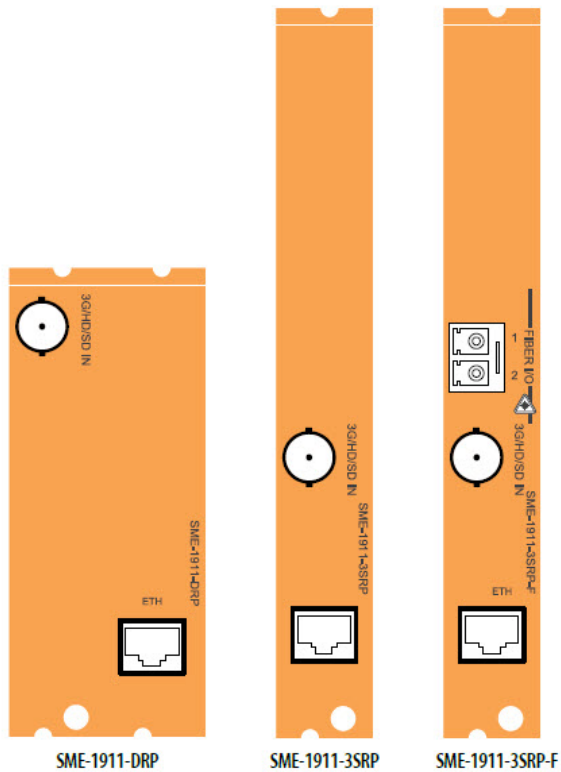

Figure 2.2 SME-1911 Rear Panels

2.3.2 Rear Panel Signal Connections

3G/HD/SD IN – Serial digital 3G/HD/SD input

Connect a serial digital video signal, conforming to the SMPTE ST424M standard for 3G input signals, SMPTE 292M standard for HD input signals or SMPTE 259M standard for SD input signals, to the BNC labeled **3G/HD/SD IN**. The SME-1901 will automatically switch to the detected line/frame rate format.

3G/HD/SD OUT – Serial digital video outputs (SME-1901 only)

The SME-1901 provides up to six 3G/HD/SD SDI video outputs on BNC or DIN 1.0/2.3 connectors, labeled **3G/HD/SD OUT 1 to 6**. The SDI video signal conforms to the SMPTE ST424M, SMPTE 292M or SMPTE 259M-C standard. The same signal is carried on all outputs.

ETH

Ethernet port, supporting 100 Mbps full or half-duplex Ethernet, and Autonegotiate, on an RJ-45 connector.

Fiber I/O (-F rear panels only)

Fiber connection via an SFP module. Use either a **single-fiber** receiver or a **single-fiber** transmitter module (1310 nm) and connect the fiber using an LC/PC connector.

3 User Interface

3.1 Control options

The SME-1901/1911 can be controlled in three different ways:

- The local control panel and its push-buttons can be used to move through a menu of parameters and to adjust a basic set of parameters (see section 4).
- Grass Valley’s iControl system can be used to access the card’s operating parameters from a remote computer, using a convenient graphical user interface (GUI) (see section 5).
- Grass Valley’s RCP-200 panel (consult factory for availability).

3.2 Card-Edge Status LED

The status monitor LED is located on the front card-edge of the SME-1901/1911, and is visible through the front access door of the DENSITÉ frame. This multi-color LED indicates the status of the SME-1901 by color, and by flashing/steady illumination.

The chart shows how the various error conditions that can be flagged on the SME-1901/1911 affect the LED state.

- If a cell is gray, the error condition cannot cause the LED to assume that state.
- If more than one LED state is possible for a particular error condition, the state is configurable.
See Section 5.10 for details.
- The factory default state is shown by a ⚙️

The LED will always show the most severe detected error status that it is configured to display, and in the chart error severity increases from left to right, with green representing no error/disabled, and flashing red the most severe error.

If the LED is Flashing Yellow, it means that the card is selected for local control using the Densité frame’s control panel. See Section 4 for details.

Error Condition	Status LED			
	Green	Yellow	Red	Flashing Red
Rear/SFP mismatch				⚙️
No SFP	⚙️			
Electrical input – no carrier			⚙️	
Optical Input – no carrier			⚙️	
Electrical input – no lock		⚙️		
Optical input – no lock		⚙️		
SFP receiver – power warning		⚙️		
SFP receiver – power error			⚙️	
SFP temperature error			⚙️	

4 Local control using the Densité frame control panel

4.1 Overview

Push the SELECT button on the SME-1901/1911 card edge (see Section 1.4) to assign the local control panel to operate the SME-1901/1911. Use the control panel buttons to navigate through the menu, as described below.

All of the cards installed in a Densité frame are connected to the frame's controller card, which handles all interaction between the cards and the outside world. There are no operating controls located on the cards themselves. The controller supports remote operation via its Ethernet ports, and local operation using its integrated control panel.

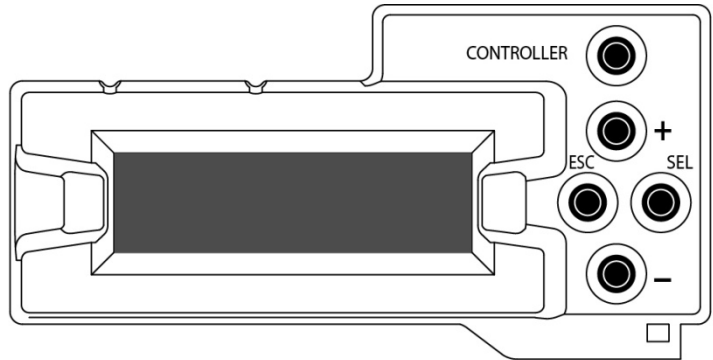

Figure 4.1 Densité Frame local control panel

The local control panel is fastened to the front of the CPU-ETH2 controller card, and when installed is located in the front center of the frame, positioned in front of the power supplies. The panel consists of a display unit capable of displaying two lines of text, each 16 characters in length, and five pushbuttons.

The panel is assigned to operate any card in the frame by pushing the SELECT button on the front edge of that card.

- Pushing the CONTROLLER button on the control panel selects the Controller card itself.
- The STATUS LED on the selected card flashes yellow.

The local control panel displays a menu that can be navigated using the four pushbuttons located beside the display. The functionality of the pushbuttons is as follows:

[+] [-] Used for menu navigation and value modification

[SELECT] Gives access to the next menu level. When a parameter value is shown, pushing this button once enables modification of the value using the [+] and [-] buttons; a second push confirms the new value

[ESC] Cancels the effect of parameter value changes that have not been confirmed; pushing [ESC] causes the parameter to revert to its former value.

Pushing [ESC] moves the user back up to the previous menu level. At the main menu, [ESC] does *not* exit the menu system. To exit, re-push the [SELECT] button for the card being controlled.

If no controls are operated for 30 seconds, the controller reverts to its normal standby status, and the selected card's STATUS LED reverts to its normal operating mode.

4.2 Menu for local control

The SME-1901/1911 has operating parameters which may be adjusted locally at the controller card interface.

- Press the SELECT button on the SME-1901 front card edge to assign the Densité frame's local control panel to the SME-1901/1911.
- Use the keys on the local control panel to step through the displayed menu to configure and adjust the SME-1901/1911.

The complete menu structure is shown in Annex 1 to this document, beginning on page 28.

5 Remote control using iControl

The operation of the SME-1901/1911 may be controlled using Grass Valley's iControl system.

- This manual describes the control panels associated with the SME-1901/1911 and their use.
- Please consult the iControl User's Guide for information about setting up and operating iControl.

In iControl Navigator or iControl Websites, double-click on the SME-1901/1911 icon to open the control panel.

5.1 The iControl graphic interface window

The basic window structure for the SME-1901/1911 is shown in figure 5.1. The window identification line gives the card type (*SME-1901* or *SME-1911*) and the slot number where the card is installed in its Densité frame.

There are three main sections in the window itself, identified in figure 5.1:

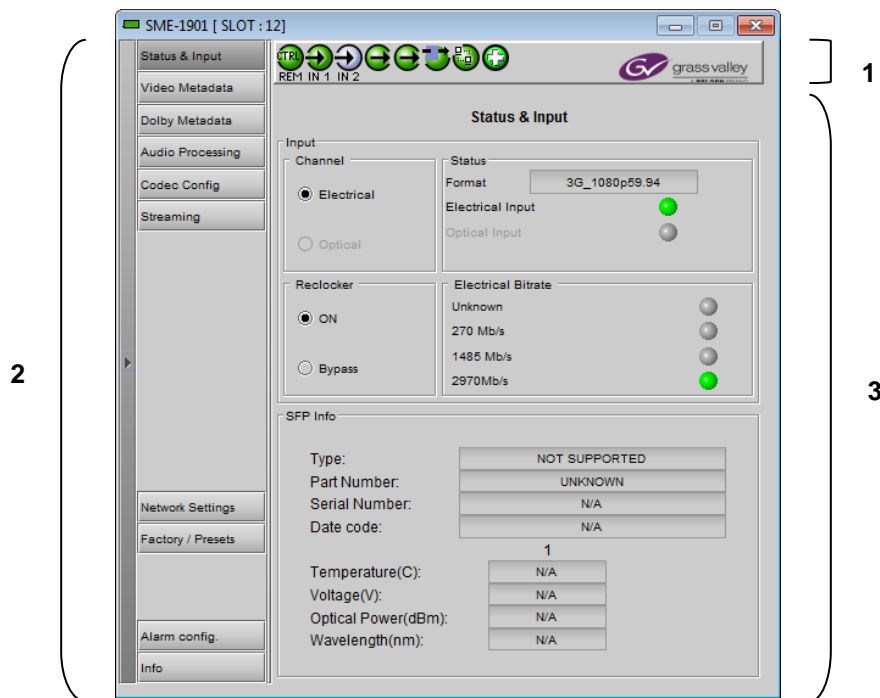

Figure 5-1 SME-1901/1911 iControl graphic interface window

Section 1. The top section displays eight icons on the left. These icons report different statuses such as card communication status, input and output signal status, card health, etc. In some instances, they relate to conditions defined through parameters settings.



Icon # 1 2 3 4 5 6 7 8











Move the mouse over an icon and a status message appears below the icon providing additional information. If there is an error, the error status message appears in the message area without mouse-over.











- If there are multiple errors, the error messages cycle so all can be seen
- The icon whose status or error message is shown is highlighted with a mauve background

The table below describes the various status icons that can appear, and how they are to be interpreted.

- In cases where there is more than one possible interpretation, read the error message in the iControl window to see which applies.

Table – iControl Status Icon interpretation

Icon #1 – Manual Card Configuration	
 (green)	Remote card control activated. The iControl interface can be used to operate the card
 (yellow)	Local card control active, The card is being controlled using the Densité frame control panel, as described in section 4. Any changes made using the iControl interface will have no effect on the card.
Icon #2 – Electrical Input (IN 1) Status	
 (green)	Carrier detected and locked <ul style="list-style-type: none"> • Mouse over the icon to see format details.
 (yellow)	Carrier detected
 (red)	Signal absent No rear
 (gray)	Optical input selected.
Icon #3 – Optical Input (IN 2) Status	
 (green)	Carrier detected and locked. <ul style="list-style-type: none"> • Mouse over the icon to see format details
 (yellow)	Carrier detected
 (red)	Signal absent No rear
 (gray)	Electrical input selected.

Icon #4 – Main Output Status	
 (green)	Status OK <ul style="list-style-type: none"> • Mouse over the icon to see format and bitrate details
 (gray)	Disabled
Icon #5 – Proxy Output Status	
 (green)	Status OK <ul style="list-style-type: none"> • Mouse over the icon to see format and bitrate details
 (gray)	Disabled
Icon #6 – Operation Mode Status	
 (green)	Operation mode: Process – normal processing of the input signal
 (yellow)	Operation mode: Color Bars – place the color bars and tone test pattern on the streaming output.
 (yellow)	Operation mode: Lipsync – place the lipsync test pattern on the streaming output.
Icon #7 – Ethernet Status	
 (green)	Ethernet Status: Link OK <ul style="list-style-type: none"> • Mouse over the icon to see the Ethernet connection mode: Autonegotiate/100 Base-TX FD/100 Base-TX HD
 (red)	Ethernet status: No link
Icon #8 – Health Monitoring	
 (green)	Hardware OK
 (red)	Hardware Health Monitoring - Hardware fault detected If this icon appears red, return the card to Grass Valley and specify the error code.

Section 2. The left portion of the window contains a series of buttons, which become highlighted when they are selected; the main panel (3) then displays the group’s set of parameters. Each of the groups is described in detail below.

Section 3. The main panel contains all the parameters specific to the group selected. It may contain several tabs to help manage the different parameters.

Each of the panels associated with the groups accessed from the buttons in Section 2, and shown in Section 3, is described individually in the following sections.

5.2 Status and Input panel

Input – Channel

Use the radio buttons to select the signal source:

- Electrical – IN 1, via BNC connector on the rear panel
- Optical – IN 2, via the fiber input connector on the rear panel.
This is only available with a –F rear panel and an appropriate SFP module installed.

Input – Status

This section of the panel shows the status of the two inputs, and also the video format detected on the selected input

Input – Reclocker

Use the radio buttons to select whether the reclocker is ON or bypassed.

Input – Electrical Bitrate

The icons in this area show the detected input bitrate, which will be one of three known values for specific video formats, or unknown if none of these matches.

[Unknown, 270 Mb/s, 1485 Mb/s, 2970 Mb/s]

SFP Info

The table of values identifies the SFP module installed in the rear panel, if supported and installed:

- Type
- Part Number
- Serial Number
- Date Code:
- Temperature (C)
- Voltage (V)
- Optical Power (dBm)
- Wavelength (nm)

Note that if the user installs an SFP module with two channels, a warning will appear at the bottom of the panel to advise that only channel 1 is supported.

WARNING: Channel 2 unsupported on this card



Figure 5-2 Status and Input panel

5.3 Video Metadata panel

This panel reports on metadata detected in the incoming video.

Closed Captioning

The icon shows the presence (green) or absence (red) of closed captioning data.

Timecode

Status icons flag the presence of two time code formats:

- DVITC/ATC-VITC
- ATC/LTC

AFD

The presence, and details if detected, of three types of AFD data are shown:

- AFD
- VLI
- WSS

Teletext

The presence of teletext data for page 1 and page 2 (actual page numbers are shown in the data boxes) is shown by the Presence and Subtitle icons.

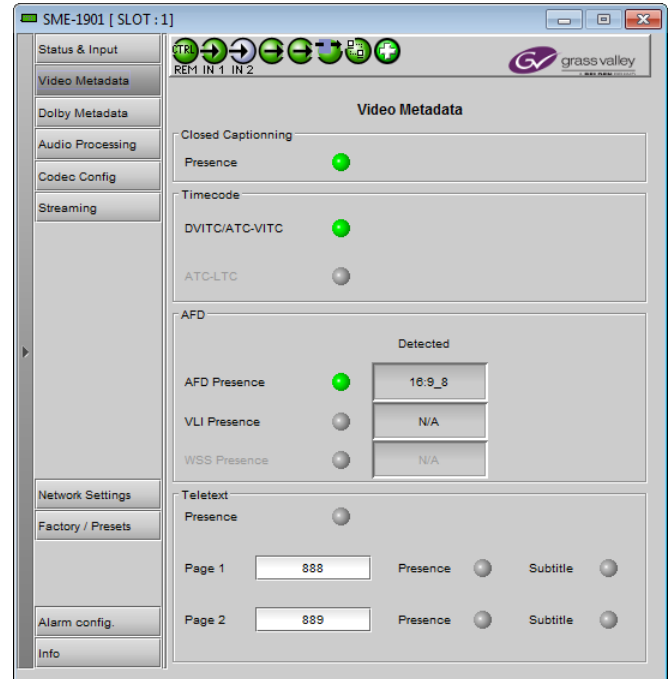

Figure 5-3 Video Metadata Panel

5.4 Dolby Metadata panel

Input Status

The presence of Dolby Metadata in the input video is flagged by the Input Status icon – green if present, red if absent.

Source

Source – The source pulldown in this version of the card is fixed at Video.

Line – use the pulldown to select between Auto detect and a specific line.

SDID – use the pulldown to select a value between 1 and 9

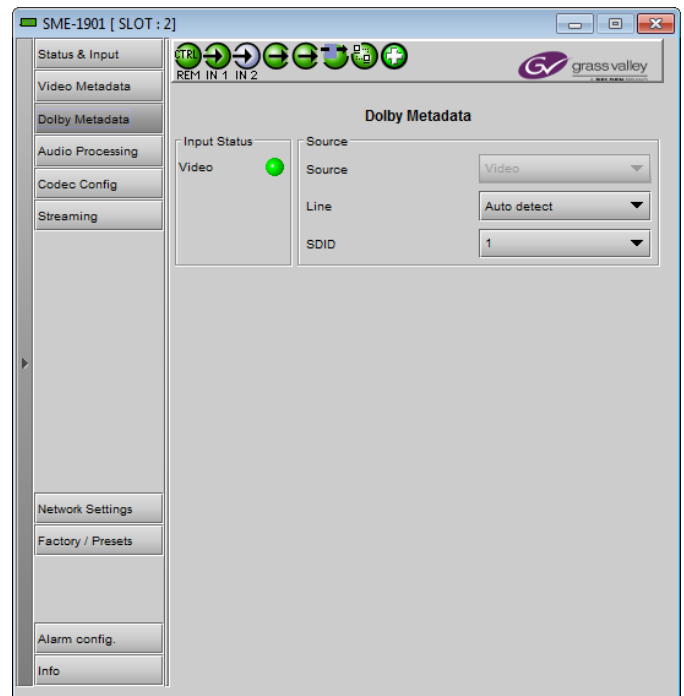

Figure 5-4 Dolby Metadata panel

5.5 Audio Processing panel

Group Detected

The four icons indicate which audio groups have been detected on the active input.

- Green icon = audio group present

Audio Type Status

The 16 icons show the type of audio input present on the input audio pairs, identified by text and icon color:

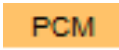
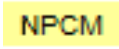
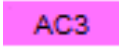
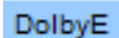
- PCM – orange icon 
- Non-PCM – yellow icon 
- AC3 – pink icon 
- Dolby E – blue icon 

Downmix – Input Channels

The six pulldowns allow the user to assign any of the 16 audio inputs to the downmix source channels:

- Left
- Right
- Center
- LFE
- Ls
- Rs

Downmix – Manual Downmix Config

Use the pulldowns to set up the details of the downmix:

Oper Mode – select the downmix operating mode

- Manual Use the other four pulldowns in this section to set up the downmix properties
- Follow Metadata Use the metadata in the incoming program to set up the downmix properties
In this mode, the other four pulldowns are inactive, but show the values derived from the metadata (if present) that are being used for the downmix.

Mode – select the type of downmix you want:

- LtRt: Enables the downmix of 5.1 channels into an LtRt (Left total Right total) matrix surround encoded stereo pair.
- LoRo: Enables the downmix of 5.1 channels into an LoRo (Left only Right only) stereo pair, which is a conventional stereo signal.



Figure 5-5 Audio Processing panel

Center Mix Level – sets the center channel downmix level to the selected value

[+3 dB, +1.5dB, 0 dB, -1.5 dB, -3 dB, -4.5 dB, -6 dB, Mute]

Surround Mix Level – sets the surround channels (Ls & Rs) downmix level to the selected value

[+3 dB, +1.5dB, 0 dB, -1.5 dB, -3 dB, -4.5 dB, -6 dB, Mute]

LFE Mix Level – sets the LFE channels downmix level to the selected value.

[+10 dB, +9 dB, +7.5, +6 dB, +4.5 dB, +3 dB, +1.5dB, 0 dB, -1.5 dB, -3 dB, -4.5 dB, -6 dB, Mute]

The block diagrams below show the configuration of the LtRt surround sound downmixer and the LoRo stereo downmixer.

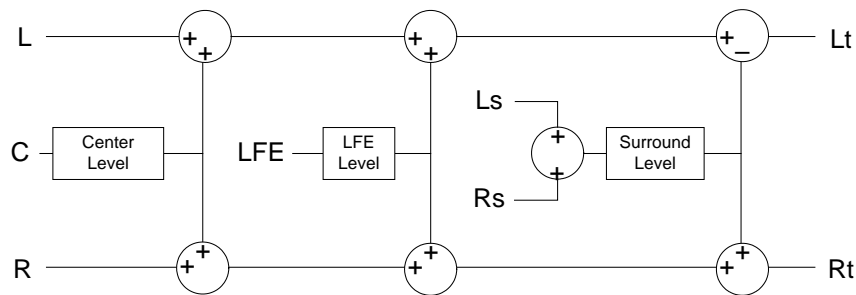

Figure 5-6 LtRt Surround Sound Downmixer

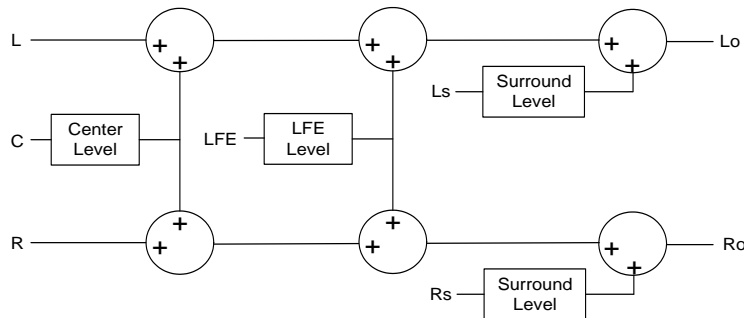

Figure 5-7 LoRo Stereo Downmixer

5.6 Codec Config panel

This panel controls the output coding process.

Audio Codec

Use the radio buttons to select whether the output audio channels are those selected in the Left and Right pulldowns (in the range 1 to 16), or the output of the downmixer (see the Audio Processing panel).

Audio Codec - Encoding

Use the pulldown to select the audio encoding scheme:

- MPEG 1 L2 @ 256 kbps
- AAC-LC @ 128 kbps

Video Codec – Force progressive mode encoding

The video encoder normally defaults to interlaced mode for interlaced formats and progressive mode for progressive formats. Some decoders cannot decode a stream encoded in interlaced mode. If this is the case, *Force Progressive Mode Encoding* should be checked. Forcing this mode for interlaced formats may cause artifacts, particularly in film-originated content.

Test Pattern (Streaming output only)

The pulldown allows the user to select an internally-generated test signal to replace the program signal at the SME-1901/1911 streaming output.

OFF: the program signal appears at the output, and test signals are OFF

Color Bars and Tone: sends a 75% color bar test pattern (100% white), along with audio test tones (a continuous tone on right channel with pulsed tone on left channel) to the SME-1901/1911 output.

Lip Sync: sends a special test signal comprising color bars and tone plus a detectable element that is used to align audio-video delays in a processing path.

- The special test signal consists of 75% color bars within which a white square is inserted every 4 seconds for a duration of 10 frames. Simultaneously with the beginning of the first field of video containing the white square, the 16 embedded audio channels are pulsed with a tone lasting 250 ms.

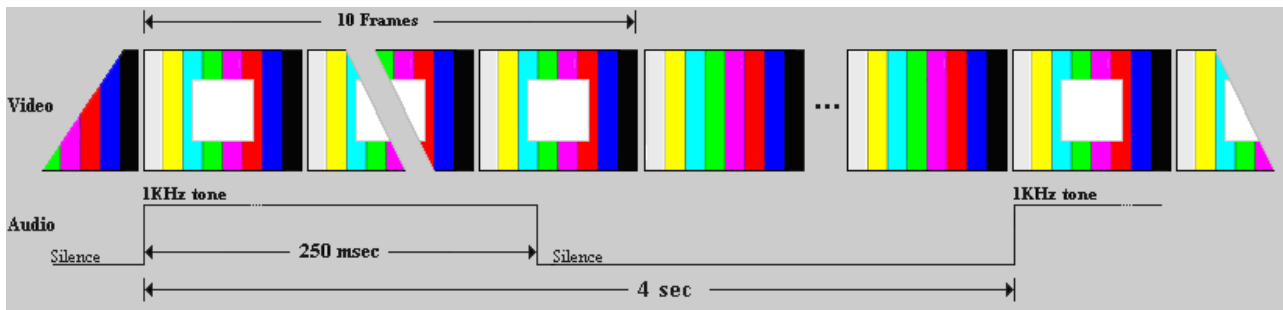

Figure 5-9 Lip Sync test signal appearance and timing

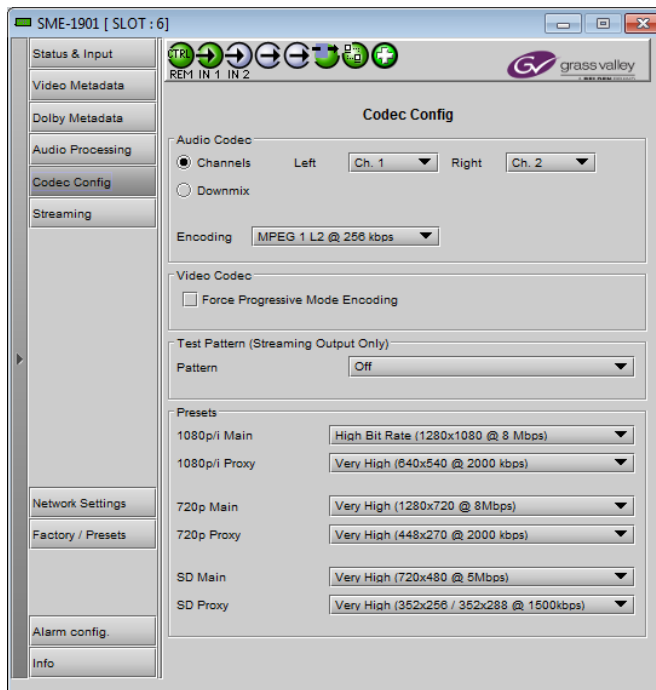

Figure 5-8 Codec Config panel

Presets

Select one of the available coding options for the Main and Proxy outputs, for 1080p/i, 720p and SD signals. The available choices are shown in the chart. The presets in **bold** are the default values:

Video	Main Output	Proxy Output
1080p/i	High bit rate (1280x1080 @ 8 Mbps)	Very High (640x540 @ 2000 kbps)
	High (1920x1080 @ 5 Mbps)	Medium (480x288 @ 750 kbps)
	Medium high (1920x1080 @ 3 Mbps)	Very low (256x160 @ 256 kbps)
	Medium (1440x1080 @ 3 Mbps)	Disabled
	Low (960x540 @ 1 Mbps)	
	Disabled	
720p	Very high (1280x720 @ 7 Mbps)	Very high (448x270 @ 2000 kbps)
	High (1280x720 @ 5 Mbps)	Medium (448x270 @ 750 kbps)
	Medium high (1280x720 @ 3 Mbps)	Very low (256x160 @ 256 kbps)
	Low (960x540 @ 1 Mbps)	Disabled
	Disabled	
SD (525/625)	Very high (720x480 / 720x576 @ 5 Mbps)	Very high (352x256 / 352x288 @ 1500 kbps)
	Medium high (720x480 / 720x576 @ 2 Mbps)	Medium (352x256 / 352x288 @ 500 kbps)
	Low (352x480 / 352x576 @ 1 Mbps)	Very low (128x96 / 128x96 @ 128 kbps)
	Disabled	Disabled

There are limitations with 1080p/i video that do not exist with 720 or SD video. For 1080p/i, the higher quality Main presets are not possible when the Proxy output is enabled. The following chart indicates the possible Main presets for each Proxy preset and the Main fall-back preset when the selected one is not possible.

Video	Proxy output	Selected Proxy preset	Possible Main presets	Impossible Main presets	Fall-back Main preset used internally
1080p/i	On	Very high	High bit rate Low Disabled	High Medium high Medium	Low
	On	Medium	High bit rate Medium Low Disabled	High Medium high	Medium
	On	Very low	High bit rate Medium Low Disabled	High Medium high	Medium
	On	Disabled	All presets	None	None
	Off	Don't care	All presets	None	None
720p	Don't care	All presets	All presets	None	None
SD (525/625)	Don't care	All presets	All presets	None	None

5.7 Streaming panel

This panel sets up the streaming output parameters, for both Main and Proxy outputs.

Streaming Protocol

Use the pulldown to select the streaming mode that applies to both Main and Proxy:

UDP/TS: This streaming mode allows the SME-19x1 to stream raw TS over UDP.

- **Unicast TS-over-UDP** (raw TS carried over UDP from a single source to a single destination)
- **Multicast TS-over-UDP** (raw TS carried over UDP from a single source to multiple destinations)

RTP/TS: This streaming mode (or RTP packetization of TS) allows the SME-19x1 to stream any of four possible streaming protocols, as follows:

- **Unicast TS-over-UDP/RTP** (raw TS carried over UDP from a single source to a single destination)
- **Multicast TS-over-UDP/RTP** (raw TS carried over UDP from a single source to multiple destinations)
- **RTSP/TS-over-UDP/RTP** (RTSP's packetization of TS and carried over UDP)
- **RTSP/TS-over-TCP** (RTSP's packetization of TS and encapsulated into an RTP-TCP connection)

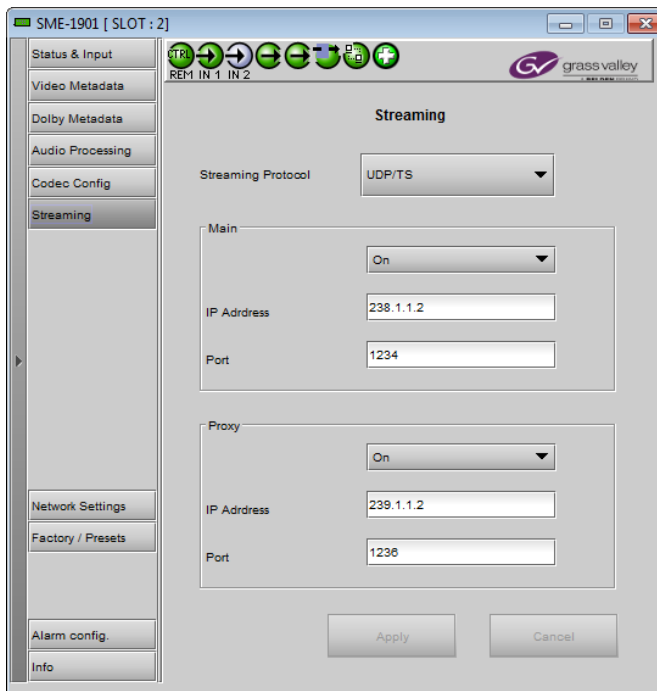

Figure 5-10 Streaming panel

The Main and Proxy streams each have the following parameters:

On/Off – use the pulldown to enable or disable the stream

IP address – enter the IP address of the destination. It is relevant for all connection types except RTPS/TS-over-UDP/RTP and RTSP/TS-over-TCP.

Port – enter the port number; valid port numbers are in the range 1024 to 65535.

After changing any of these parameters, you must click **Apply** for the changes to take effect, or **Cancel** to discard the changes.

The decoder or set-top box will require a URL. It will have a different form depending on the chosen Streaming Protocol. The following description gives examples for the VideoLAN VLC Media Player software. Please refer to your decoder or set-top box documentation.

Unicast TS-over-UDP and TS-over-UDP/RTP

```
<protocol>://@<unicast IP>:<port>
```

The <protocol> is either `udp` or `rtp` depending on the chosen Streaming Protocol. The <unicast IP> and <port> of the destination is the Main or Proxy IP Address and Port from the Streaming Panel.

```
udp://@10.1.1.100:10000
rtp://@10.1.1.100:10002
```

Multicast TS-over-UDP and TS-over-UDP/RTP

```
<protocol>://<source IP>@<multicast IP>:<port>
```

The <protocol> is either `udp` or `rtp` depending on the chosen Streaming Protocol. The <source IP>, if it is used, is the card's IP Address from the Network Settings panel. This will depend on the IGMP configuration in the network equipment (switch or router). The <multicast IP> and <port> is the Main or Proxy IP Address and Port from the Streaming Panel.

- No IGMP
 - `udp://@239.1.1.100:10000`
 - `rtp://@239.1.1.100:10002`
- IGMP Any Source Multicast (ASM)
 - `udp://0.0.0.0@239.1.1.1:10000`
 - `rtp://0.0.0.0@239.1.1.1:10002`
- IGMP Specify Source Multicast (SSM)
 - `udp://192.168.0.1@239.1.1.1:10000`
 - `rtp://192.168.0.1@239.1.1.1:10002`

RTSP/TS-over-UDP/RTP and RTSP/TS-over-TCP

```
Main stream: rtsp://<card IP>/hiProxy
Proxy stream: rtsp://<card IP>/loProxy
```

The <card IP> is the card's IP Address from the Network Settings panel.

During the RTSP session, the card will also send a Unicast/Multicast RTP stream to the destination located at the IP Address from the Streaming Panel. If this is not required, set the IP Address to 0.0.0.0.

5.8 Network Settings panel

This panel sets up the IP address of this card on the Ethernet.

IP Config

Type values directly into the data boxes for IP address, Mask and Gateway.

- Obtain the appropriate addresses from your IT department as required.

If you have made changes, you must click **Apply** for the changes to take effect, or **Cancel** to discard the changes.

Ethernet

Use the pulldown to select the speed of the ethernet connection:

- Autonegotiate
- 100 Base-TX FD [Full Duplex]
- 100 Base-TX HD [Half Duplex]

The status icon is green when the ethernet is connected.

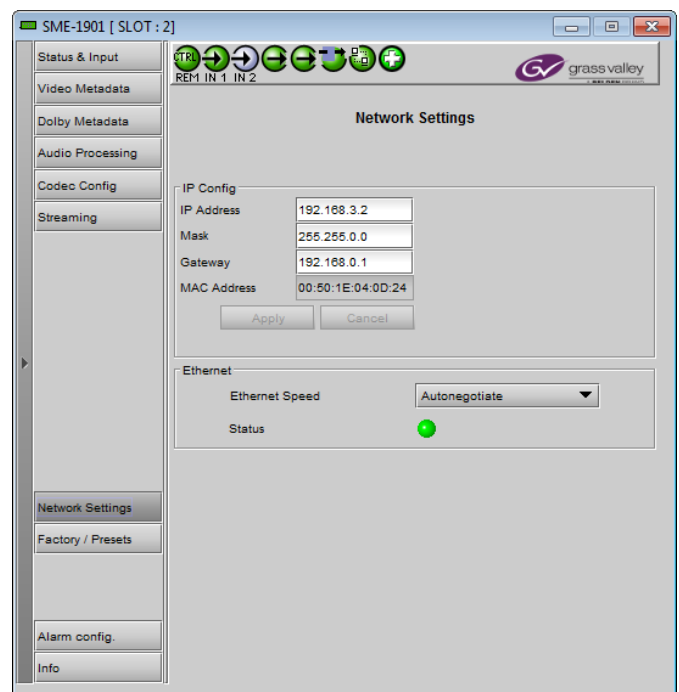

Figure 5-11 Network Settings panel

5.9 Factory/Presets panel

Factory

Load Factory: Clicking this button will restore the card to a factory default state.

- Note that User Presets 1-5 and IP settings are not changed.
- IP settings can be reset separately using the Reset IP... button below.

User Presets

The SME-1901 and SME-1911 have five memory registers which can store user-defined sets of parameter values.

- The User presets do not include IP parameters.

Select any one of the five presets using the pull-down list. The name of the currently-selected User Preset is shown on the pulldown box.

Click **Load** to load the contents of the selected User Preset into the SME-1901 or SME-1911. All parameter settings and values will be replaced by the contents of the selected User Preset.

Click **Save** to store the current parameter settings and values from the SME-1901 or SME-1911 into the selected User Preset. The existing contents of the preset will be overwritten.

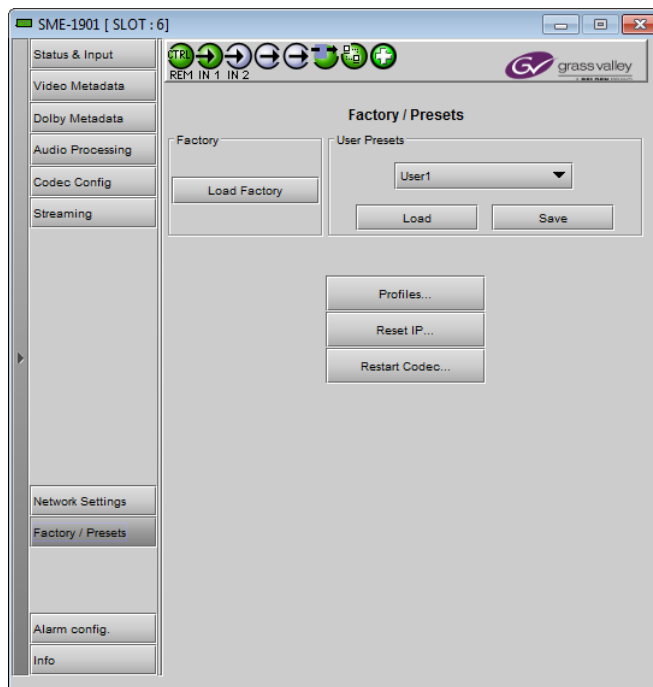

Figure 5-12 Factory / Presets panel

Profiles

This section provides the option to save and recover card configurations (current, or as stored in the User Presets) on an external disk, or to copy them to another SME-1901 or SME-1911 card.

Note: although the SME-1901 and SME-1911 are very similar in most aspects of their operation, the profiles for these cards are **NOT** interchangeable, and you must use the card-specific file in the following procedure.

Click on *Profiles* to open the Profile Copy window.

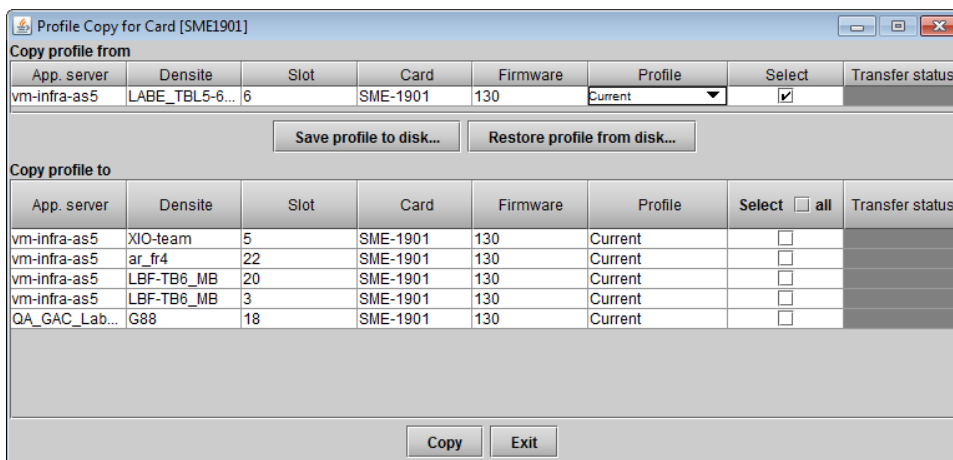

Figure 5-13 Profile Copy window

Copy profile from

This line shows this SME-1901 or SME-1911 card, and identifies it by App server, Densité frame and slot number, card type and firmware version.

The *Profile* column has a pulldown that allows you to select which profile you will work with, and gives these choices:

- Current, User1, User2, User3, User4, User5

The *Select* column includes a checkbox (preselected checked) to confirm that you want to work with the current card.

Save Profile to Disk...

Click this button to open a Save dialog allowing you to specify a file name and location to which the selected profiles for this card will be saved.

Hint - It is a good idea to create a folder for these files, because they are not explicitly identified as SME-1901 or SME-1911 profiles, and will be difficult to find and identify if not clearly named and conveniently located.

- Click the save button once the name and location have been identified in the Save box
- If the file is saved correctly, the Transfer Status box on the right of the *Copy profile from* line will indicate *Succeeded* against a green background.
- If the file was not saved for some reason, the Transfer Status box to the right of the *Copy profile from* line will indicate *Failed* against a red background

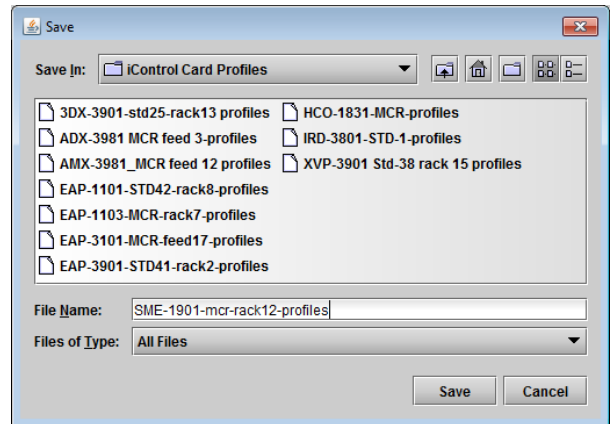
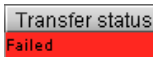
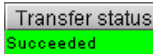

Figure 5-14 Save Profile to Disk dialog

Restore profiles from disk...

Click this button to open an *Open* dialog box within which you can locate and select a valid SME-1901 or SME-1911 profile file.

- Click Open to read the contents of the file and to reconfigure this SME-1901's or SME-1911's profiles according to its contents
- While the reconfiguration is in progress, the Transfer Status box on the right of the *Copy profile from* line will indicate *Working* against a yellow background
- When the reconfiguration is complete, the Transfer Status box on the right of the *Copy profile from* line will indicate *Succeeded* against a green background

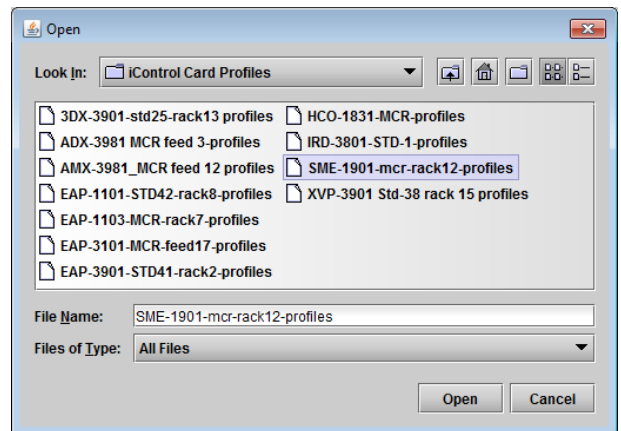

Figure 5-15 Restore Profiles from Disk dialog

Copy profile to section

This line shows other SME-1901 or SME-1911 cards that are available on the iControl network, each identified by App server, Densité frame and slot number, card type and firmware version.

The *Profile* column shows the same information as is shown for the current card in the Copy profile from line, i.e. one of the following:

- Current, User1, User2, User3, User4, User5

The *Select* column includes a checkbox to identify which SME-1901 or SME-1911 cards you wish to copy profiles into from the current card.

- For convenience, a *Select all* checkbox is provided in the column header.

Click *Copy* to copy the selected profiles from this card into the selected other SME-1901 or SME-1911 cards.

- While the profile copy operation is in progress, the Transfer Status box on the right of the *Copy profile to* line will indicate *Working* against a yellow background.
- When the profile copy operation is complete, the Transfer Status box on the right of the *Copy profile to* line will indicate *Succeeded* against a green background.

Reset IP

Click the button to reset the SME-1901/1911 IP configuration and streaming configuration to the indicated factory preset values, overriding and replacing the values in the [Network Settings](#) and [Streaming](#) panels.

A warning panel allows you to confirm or reject the reconfiguration.

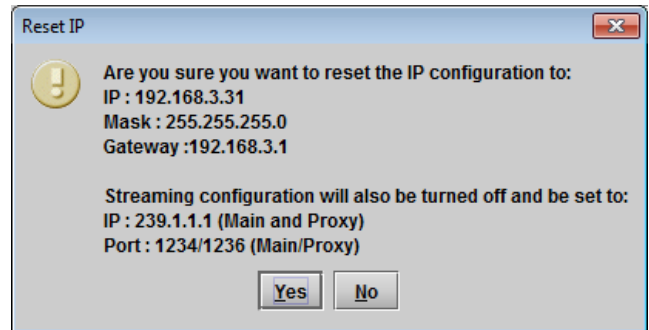

Figure 5-16 Reset IP confirmation

Restart Codec...



If the streaming output appears blocked or locked up after the input signal format changes, click this button to restart the codec. It may take up to 100 seconds to resume streaming.

A warning panel allows you to confirm or reject the restart.

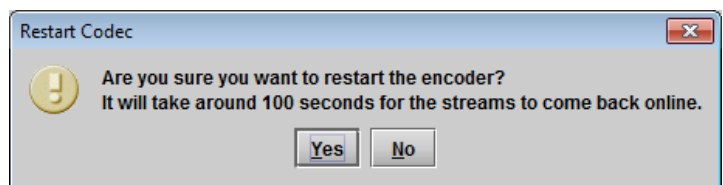

Figure 5-17 Restart Codec confirmation

5.10 Alarm Config panel

This panel allows the alarm reporting of the SME-1901/1911 to be configured. The panel opens in a new window when the button is clicked, and can be resized if needed. The panel is organized in columns.

Status/Name

This contains an expandable tree listing all the alarms reported by this SME-1901/1911 card.

- Each alarm name includes an icon that shows its current status
- Some alarms may be text-only and the alarm status is shown in the name and not by a status icon

The **Card LED**, **Overall alarm** and **GSM contribution** columns contain pulldown lists that allow the level of contribution of each individual alarm to the alarm named in the column heading to be set.

- Click on the alarm icon to see the available levels; then click on one to select it



Card LED

This column allows configuration of the contribution of selected individual alarms to the status LED located on the front card edge. The Card LED status is shown at the bottom of the alarm tree in the Status/Name column.

Overall Alarm

This column allows configuration of the contribution of each individual alarm to the Overall Alarm associated with this card. The Overall Alarm is shown in the upper left corner of the iControl panel, and also appears at the bottom of the Status/Name column.

GSM Contribution

This column allows configuration of the contribution of each individual alarm to the GSM Alarm Status associated with this card. GSM is a dynamic register of all iControl system alarms, and is also an alarm provider for external applications. The possible values for this contribution are related to the Overall alarm contribution:

- If the Overall alarm contribution is selected as Disabled, the GSM alarm contribution can be set to any available value
- If the Overall alarm contribution is selected as any level other than disabled, the GSM contribution is forced to follow the Overall Alarm.

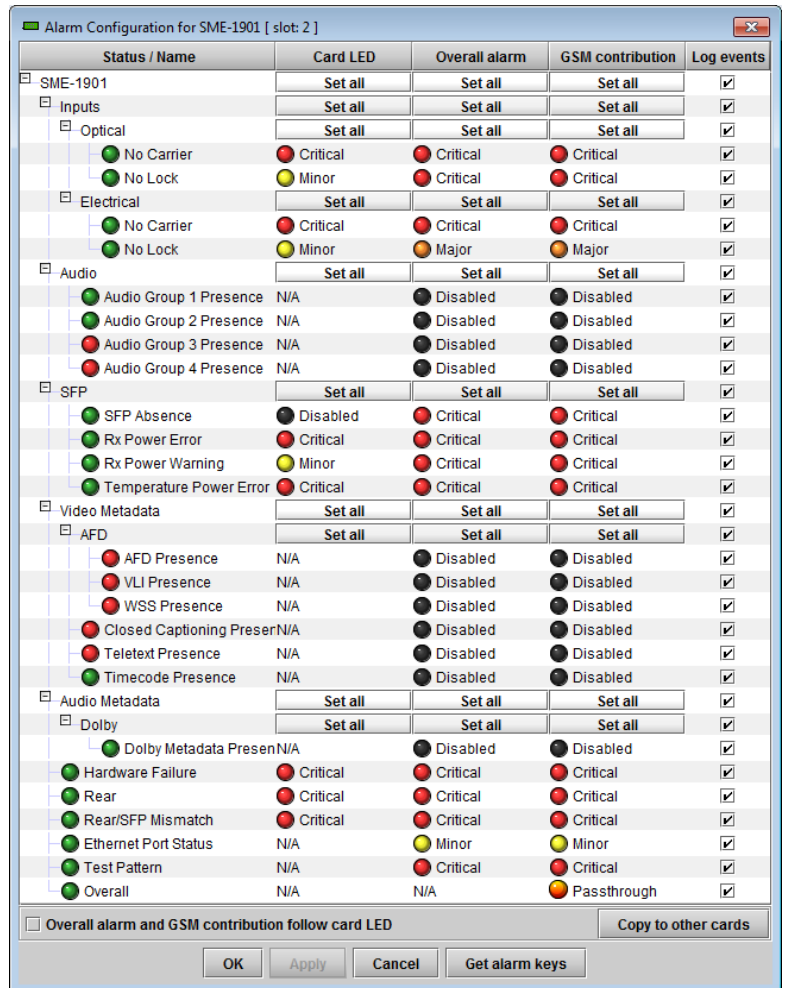







Figure 5-18 Alarm Configuration panel

Levels associated with these alarms:

The pulldown lists may contain some or all of the following options:

-  Disabled The alarm makes no contribution (black icon)
-  Minor The alarm is of minor importance (yellow icon)
-  Major The alarm is of major importance (orange icon)
-  Critical The alarm is of critical importance (red icon)
-  Passthrough The alarm exists but has no effect (used for text and composite alarms)

Shortcut: if you click in one of the Set All boxes beside a section heading, you will open a pulldown that lets you assign a level to all alarms in that section of the column simultaneously.

Once the alarms are configured, you may accept the changes or discard them:

Log Events

iControl maintains a log of alarm events associated with the card. The log is useful for troubleshooting and identifying event sequences. Click in the checkbox to enable logging of alarm events for each individual alarm.

At the bottom of the window are several other controls

Overall alarm and GSM contribution follow card LED

Click in the checkbox to force the Overall alarm and GSM contribution to be identical to the Card LED status

- All Overall alarms and GSM contributions for which there is a Card LED alarm will be forced to match the Card LED alarm
- All Overall Alarms and GSM contributions for which there is no Card LED alarm will be forced to Disabled

A warning box will open allowing you to confirm the action, since it will result in changes to the configuration and there is no *undo* function.

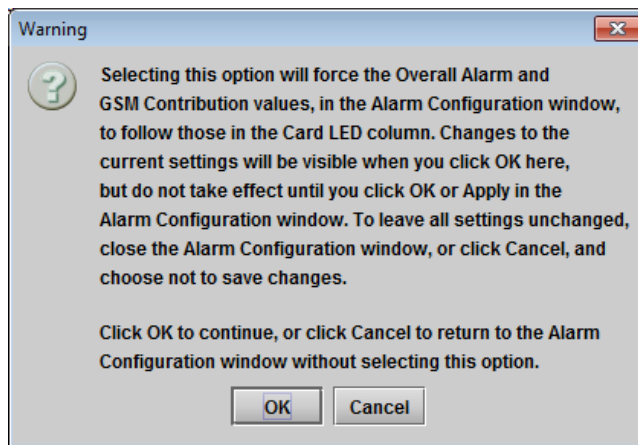

Figure 5-19 Warning for Follow LED change

Copy to other cards

Click this button to open a panel that allows the alarm configuration set for this card to be copied into another SME-1901/1911 card.

- Select one or more destination cards from the list in the window by clicking in the checkboxes, or all of them by clicking in the *All* checkbox
- Note that when you do a Copy Profile for this card (see Sect.5.9), the alarm configuration is copied along with all the other settings.

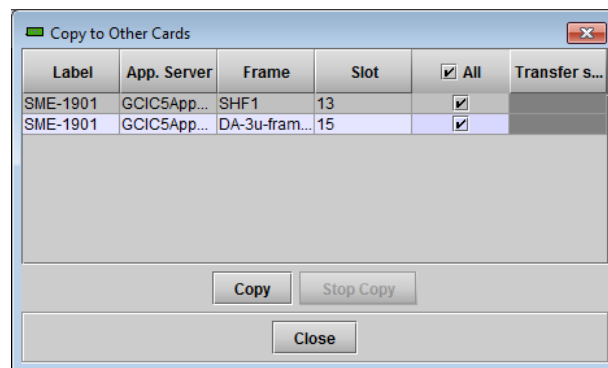

Figure 5-20 Copy to Other Cards window

Get alarm keys

Click this button to open a save dialog where you can save a file containing a list of all alarms on this card and their current values, along with an Alarm Key for each. The alarm keys are useful for system integration and troubleshooting.

- The file is saved in .csv format

OK, Apply, Cancel

- **OK** accepts the settings and closes the window once the card confirms that there are no errors.
- **Apply** accepts the settings, but leaves the window open
- **Cancel** closes the window without applying any changes, and leaves the previous settings intact.

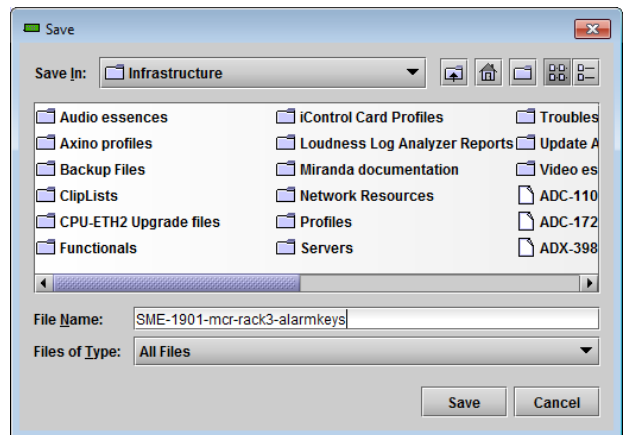

Figure 5-21 Get Alarm Keys dialog

5.11 Info panel

When the SME-1901 or SME-1911 is included in an iControl environment, certain information about the card should be available to the iControl system. The user can enter labels and comments that will make this card easy to identify in a complex setup. This information is entered into data boxes in the Info control panel.

- Label:** type the label that is shown for this SME-1901/1911 when it appears in iControl applications
- Short Label** type the short-form label that iControl uses in some cases (8 characters)
- Source ID** type a descriptive name for SME-1901/1911
- Comments:** type any desired text

The remaining data boxes show manufacturing information about this card.

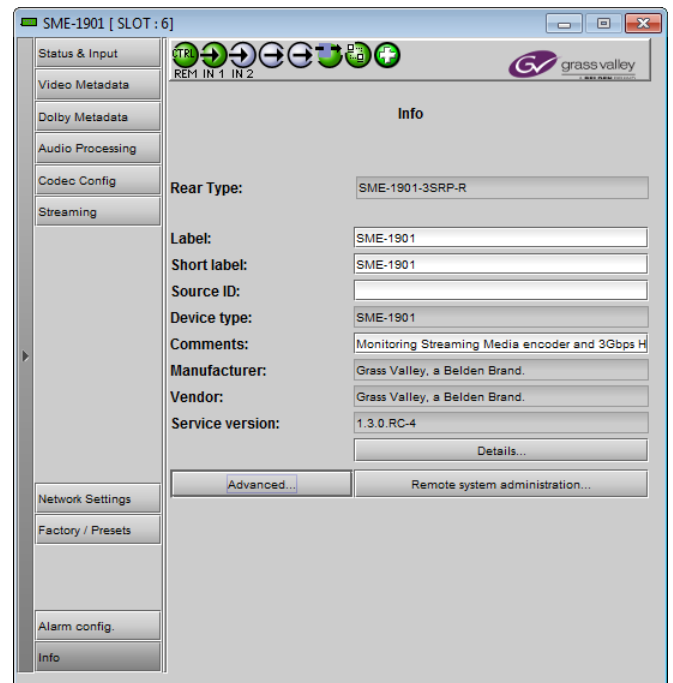

Figure 5-22 Info panel

Three buttons in the panel give access to other information.

- **Details...:** Reports the Firmware version, service version, and panel version for this card.

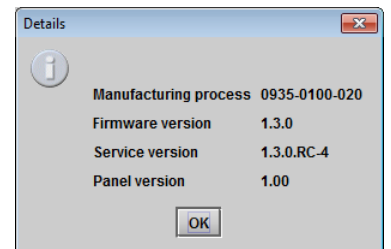

Figure 5-23 Details window

- **Advanced...**: Shows the Long ID for this card. The Long ID is the address of this SME-1901/1911 in the iControl network.

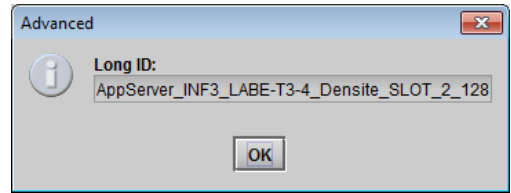

Figure 5-24 Advanced window

- **Remote System Administration** – opens the Joining Locators window, which lists remote lookup services to which this SME-1901/1911 is registered

Add: Force the iControl service for this SME-1901/1911 to register itself on a user-specified Jini lookup service, using the following syntax in the data box:

jini://<ip_address>

where <ip_address> is the ip address of the server running the lookup service, e.g.:

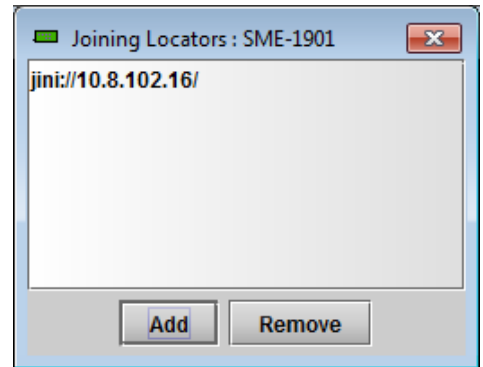
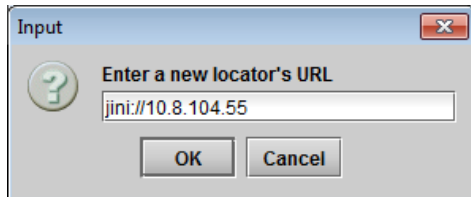
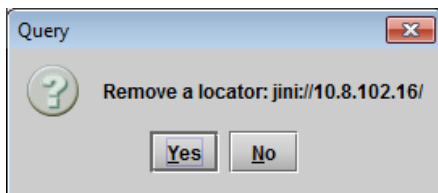

Figure 5-25 Joining Locators window



Remove: select one of the services listed in the window by clicking on it, and click *Remove* to open a query box allowing you to delete it from the window.



6 Specifications

ELECTRICAL INPUT

Signal:	3Gbps/HD/SD-SDI SMPTE 424M, 292M, and 259M-C compliant
Supports data rates of:	270, 1483.5, 1485, 2967, 2970 Mbps
Cable length * (Belden 1694A):	3 Gbps: 110 m (360 ft) at 3 Gbps HD: 200 m (655 ft) at 1.5 Gbps SD: 400 m (1310 ft) at 270 Mbps
Return loss *:	>15 dB for up to 1.5 GHz >10 dB from 1.5 GHz to 3 GHz

IP INPUT/OUTPUT

Quantity:	1
Connector:	100 Mbps Ethernet with RJ45 connector IEEE 802.3

PROCESSING PERFORMANCE: IP Streaming

Signal path:	8 bits
Compression:	H.264 high profile (level 4.0)
Frame rate:	Full rate of input signal – except 3G is half the rate
Bitrate:	128 Kb/s to 8 Mb/s
Audio encoding:	AAC-LC, MPEG-1 Layer II

ELECTRICAL OUTPUTS (6) (SME-1901 only)

Signal:	3Gbps/HD/SD-SDI SMPTE 424M, 292M, and 259M-C compliant
Supports data rates of:	270, 1483.5, 1485, 2967, 2970 Mbps
Return loss:	>15 dB for up to 1.5 GHz >10 dB from 1.5 GHz to 3 GHz
Jitter (wideband):	HD/SD: <0.2 UI 3 Gbps: <0.3 UI
Rise / fall time:	HD: 135 ps max., 20 % to 80 % SD: 400 - 800 ps, 20 % to 80 %

PROCESSING PERFORMANCE: DA section (SME-1901 only)

Signal path:	10 bits
Latency:	<6 ns

ELECTRICAL

Power: SME-1901	10 W
SME-1911	9 W

* Cable length and return loss specifications will be reduced when using the output protected by the bypass relay on SME-1901-3SRP-R rears.

7 Contact Us

Grass Valley Technical Support

For technical assistance, contact our international support center, at 1-800-547-8949 (US and Canada) or +1 530 478 4148.

To obtain a local phone number for the support center nearest you, please consult the *Contact Us* section of Grass Valley's website (www.grassvalley.com).

An online form for e-mail contact is also available from the website.

Corporate Head Office

Grass Valley
3499 Douglas-B.-Floreani
St-Laurent, Quebec H4S 2C6
Canada

Telephone: +1 514 333 1772

Fax: +1 514 333 9828

www.grassvalley.com

:

ANNEX 1 – SME-1901/1911 Local User Interface

Levels			Status/Parameters	Comments
1	2	3		
STATUS				
GENERAL			[SYS OK], [NO REAR / SME-1901-3SRP-F / SME-1901-3SRP-R / SME-1901-3SRP / SME-1901-DRP-F / SME-1901-3SRP-D-F], [SFP [RX TX MISMATCH], [TEST ENABLED]	
VIDEO INPUT			NO SIGNAL / NO LOCK / SD 525 / HD 1080i60 / HD 1080i59.94 / HD 1080p30 / HD 1080pSF30 / HD 1080p24 / HD 1080pSF24 / HD 720p60 / HD 720p59.94 / HD 720p30 / HD 720p24 / SD 480p / SD 525p / SD 525p 27MHz / 3G 1080p60 [A / B / B2] / 3G 1080p59.94 [A / B / B2] / SD 525 YC / GFX 1600x1200 60 / GFX 1920x1200 60 / SD 625 / HD 1080i50 / HD 1080p25 / HD 720p50 / HD 720p25 / SD 576p / SD 625p50 / SD 625p50 27MHz / 3G 1080p50 [A / B / B2] / UNKNOWN	
EMBEDDED AUDIO			GRP[1-4] [ABSENT / PRESENT]	
DOLBY METADATA			ABSENT / program config	See Dolby documentation for the list of program configs
NETWORK			DOWN / UP 100 [HD / FD] [AUTO]	
MAC ADDRESS			aabb ccdd eeff	6 bytes in hex format
CONFIG				
LOAD			USER 1, USER 2, USER 3, USER 4, USER 5	
SAVE			USER 1, USER 2, USER 3, USER 4, USER 5	
DA				
INPUT			<u>ELECTRICAL</u> , OPTICAL	
RECLOCKER			BYPASS, <u>ON</u>	
STREAMING				
MAIN STREAM		ACTIVATION	<u>OFF</u> , ON	
		IP ADDRESS	xxx.xxx.xxx.xxx	default 239.1.1.1
		PORT	xxxxx	default 1234

GUIDE TO INSTALLATION AND OPERATION

PROXY STREAM	ACTIVATION	<u>OFF</u> , ON	
	IP ADDRESS	xxx.xxx.xxx.xxx	default 239.1.1.1
	PORT	xxxxx	default 1236
TEST PATTERN		<u>OFF</u> , COLOR BARS, LIP SYNC	
CONFIGURE ALARMS			
REAR/SFP MIS	LEVEL	GREEN, YELLOW, RED, <u>FLASHING RED</u>	
	REPORT	<u>NONE</u> , GPI	
NO SFP	LEVEL	<u>GREEN</u> , YELLOW, RED, FLASHING RED	
	REPORT	<u>NONE</u> , GPI	
ELECT NO CARRIER	LEVEL	GREEN, YELLOW, <u>RED</u> , FLASHING RED	
	REPORT	<u>NONE</u> , GPI	
OPTIC NO CARRIER	LEVEL	GREEN, YELLOW, <u>RED</u> , FLASHING RED	
	REPORT	<u>NONE</u> , GPI	
ELECT NO LOCK	LEVEL	GREEN, <u>YELLOW</u> , RED, FLASHING RED	
	REPORT	<u>NONE</u> , GPI	
OPTIC NO LOCK	LEVEL	GREEN, <u>YELLOW</u> , RED, FLASHING RED	
	REPORT	<u>NONE</u> , GPI	
SFP RX PWR WARN	LEVEL	GREEN, <u>YELLOW</u> , RED, FLASHING RED	
	REPORT	<u>NONE</u> , GPI	
SFP RX PWR ERROR	LEVEL	GREEN, YELLOW, <u>RED</u> , FLASHING RED	
	REPORT	<u>NONE</u> , GPI	
SFP TEMP ERROR	LEVEL	GREEN, YELLOW, <u>RED</u> , FLASHING RED	
	REPORT	<u>NONE</u> , GPI	
NETWORK SETTINGS			
IP ADDRESS		xxx.xxx.xxx.xxx	default 192.168.3.31
NET MASK		xxx.xxx.xxx.xxx	default 255.255.255.0
GATEWAY		xxx.xxx.xxx.xxx	default 192.168.3.1
VERSION		X.Y.Z.B	version X.Y.Z build B
FACTORY DEFAULT		RESTORE	restore parameters to underlined values

ANNEX 2 – Upgrading the SME-1901 / SME-1911

The SME-1901/SME-1911 is designed to be upgraded without interrupting the card's DA section.

Upgrading to a new firmware/software release is accomplished using the Densité Upgrade Manager that is available in iControl Navigator (appserver) v5.0 and later and iControl Solo v6.0 and later. This method may not be possible because of the network topology or restricted access to the site. If this is the case, an alternate method is now available when the installed firmware version is 1.2.0 or later.

For a more complete discussion of this application, including functionality not included in this single-card upgrade description, consult the following documents:

- iControl (appserver) v5.0 User Guide, document M226-9900-282 or later: "Working with Densité Upgrade Manager" in the chapter "Configuring Devices and Services"
- iControl Solo v6.0 User Guide, document M786-1600-328 or later: "Working with Densité Upgrade Manager" in the chapter "Using iControl Solo"

The upgrade method will depend on the way the equipment is connected to the network. Whether using the recommended or alternate method, the first step is to acquire the upgrade package file from Grass Valley and save it on your computer. For version X.Y.Z, it will be named:

SME-1901-vXYZ-iControl_upgrade_package.zip (for SME-1901)

SME-1911-vXYZ-iControl_upgrade_package.zip (for SME-1911)

Recommended upgrade procedure:

The recommended method uses the Densité Upgrade Manager and takes approximately two minutes. It requires that the Ethernet port on the card's rear panel, normally used for streaming, be connected to the same subnetwork as the iControl appserver or PC running iControl Solo. There are two configurations to choose from.

Configuration 1: on-site

Usually the appserver or PC is on the "control" network and the card streams on a separate "data" network. Nevertheless, an upgrade can be performed in these conditions. With iControl Solo, use a PC with two network interfaces, one connected to the same "control" network as the Densité frame, and the other to the same "data" network as the card's Ethernet port.

Configuration 2: off-site

If this is not possible, another option is to set up a separate environment for card upgrades. On a different local network, connect a Densité frame, insert the cards to upgrade in this frame, connect their rear panel Ethernet ports and finally connect the PC running iControl Solo or the iControl appserver. Ensure that the card's Ethernet port can be accessed since it is used for the upgrade procedure. This can be configured in the Network Settings panel. Click **Apply** after modification.

From here on, the term iControl will be used to designate iControl Navigator on the appserver of iControl Solo running on a PC.

1. Open iControl linked to the frame containing the card you wish to upgrade and double-click on the SME-1901/SME-1911 card's icon to open its control panel
2. In the Streaming panel, turn both streaming ports **OFF**. This will accelerate the upgrade procedure.

It is not necessary to set all the Codec presets to DISABLED in the Codec Config panel.

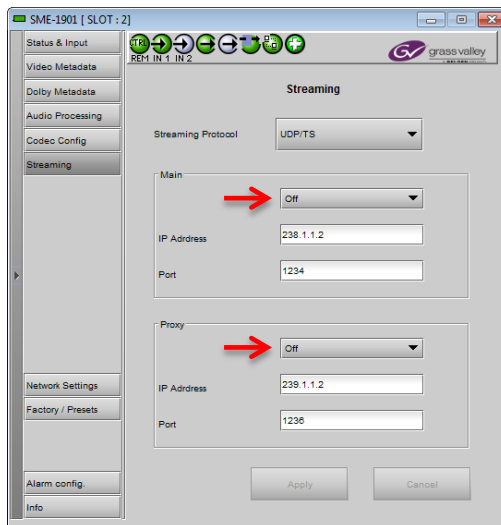

3. Close the SME-1901/SME-1911 control panel by clicking the  icon in the upper right corner.
4. In iControl, select *Densite Upgrade Manager* from the Tools pulldown menu

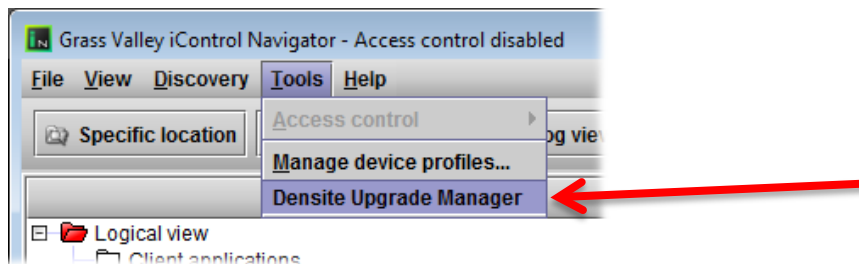

5. In the *Densite Upgrade Manager* window, click **Upload Files...**

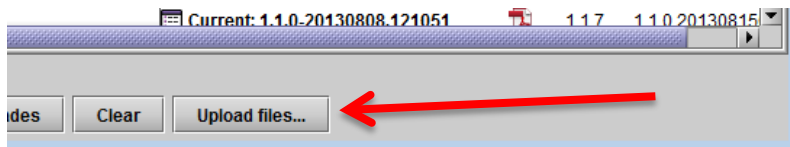

6. In the *Open* dialog, navigate to the upgrade file you saved, select it, and click **Open**. Then click **Upload**.

The selected file is uploaded, and saved on the appserver or PC. Click Close to return to the *Densite Upgrade Manager* window.

7. Locate the card you wish to upgrade in the *Densite Upgrade Manager* window, and click the down-arrow in the *Available package* column.
The pulldown list should include the new upgrade package that you uploaded to the appserver or PC in the previous step.

Version XYZ appears in the *list* as:

X.Y.Z-RC-N

where N is the package's Release number. This is only used to differentiate the package with a beta version that may exist.

8. Click on the new upgrade package name in the *Available package* pulldown list.
- The selected name will appear in the available package column.
 - The Select/Bypass checkbox will be selected for that card.
 - The Install progress window will become active, showing 0.0%.
 - The *Installed package*, *Installed firmware* and *Installed software* columns will show the upgrade path that is proposed; i.e. the existing version, and the version that will replace it.
 - The *Upgrade* button at the bottom of the *Densite Upgrade Manager* window will become enabled.

Multiple SME-1901/SME-1911 cards can be upgraded simultaneously by selecting the upgrade package for each.

9. Click **Upgrade**

The *Upgrade confirmation* window appears. Click **Yes**.

Observe the *Install Progress* window to see the current status of the upgrade. While the upgrade is in progress, the card LED is Yellow.

When the upgrade has been completed, the window will display the message "Upgrade succeeded" on a green background.

Look at the *Installed package*, *Installed firmware* and *Installed software* columns to verify that the upgrade has been correctly installed.

10. Close the *Densite Upgrade Manager* window by clicking the  icon in the upper right corner.
11. In iControl, double-click on the updated SME-1901/SME-1911 card's icon to open its control panel. Enable the streaming ports that were previously disabled in step 2. If the IP address was modified for the upgrade, set it to the previous IP address. The procedure is now complete for this card.

Alternate upgrade procedure:

If the recommended procedure is not possible, an alternate upgrade method exists when firmware version 1.2.0 or later is already installed in the SME-1901/SME-1911. The procedure does not require the rear panel Ethernet port so no changes have to be done to the equipment. This upgrade process will take approximately two hours per card. Although the iControl card panel will not be available during the upgrade, the SME-1901/SME-1911 remains functional until the end of the process at which time the card is automatically rebooted.

The software utility used to upgrade the SME-1901/SME-1911 is called *Miranda Interface Updater*. It is available in iControl Navigator (appserver) v4.x, iControl Solo v4.x, or as a stand-alone Java application. Contact Grass Valley to obtain the stand-alone application.

The upgrade file used here is contained in the zip file obtained from Grass Valley. Before beginning the procedure below, open the zip file and extract the file named:

firmware-X.Y.Z.B.zip

where X.Y.Z is the package version and B is the build number. This file is the upgrade package used in the procedure below.

1. The Densité frame containing the SME-1901/SME-1911 card to upgrade must not be *Online* in the iControl Densité Manager. If it is in the list, set it to *Standby* for the duration of the upgrade procedure.
2. Click **Miranda Interface Updater** in the Tools menu of iControl Navigator v4 or higher, or iControl Solo v4 or higher to execute the stand-alone version.

Enter the Densité frame's IP address in the Densité IP address box and click **Connect**.

Click **Open** and choose the upgrade package. The Upgrade Version displayed will only display the X in the X.Y.Z version number.

The SME-1901/SME-1911 cards in the frame will no longer be grayed. It is now possible to select the cards to upgrade using the checkboxes in the Select column.

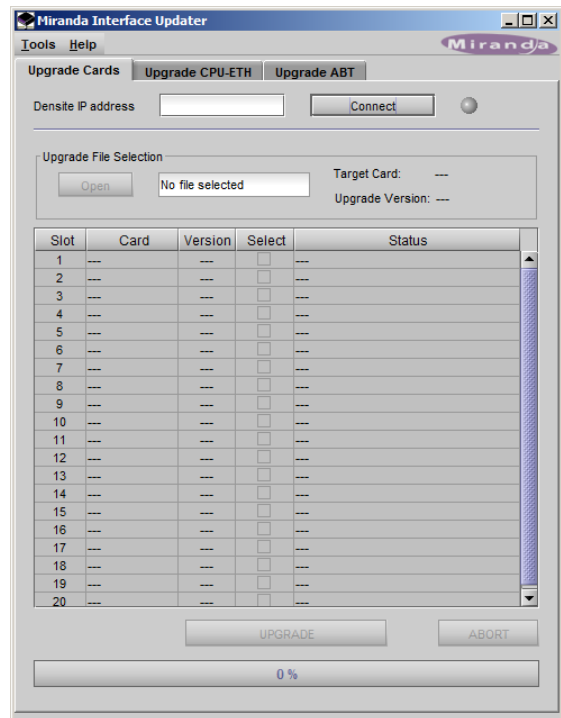

3. Click **Upgrade**. A message box will appear with a cautionary statement. Click **Yes** to continue.

The process will take approximately two hours for each card. While the upgrade is in progress, the card icon is Yellow.

When the upgrade has been completed for a card, the message "Upgrade Successful" on a green background will be displayed in the Status column.

4. Close the *Miranda Interface Updater* window by clicking the  icon in the upper right corner.