



grass valley

A **BELDEN** BRAND

XIP-3901

Agile SDI/IP Processing Platform

User Manual

13-03065-010-AI-M00

2020-07-31

www.grassvalley.com

Document History

Document Number	Publication Date	Notes
13-03065-010-AA-M00	2018-06-14	Initial release
13-03065-010-AB-M00	2018-09-25	External reference support for XIP-3901-UC 1.1 XIP-3901-DC 1.0 release Agile processing platform manager for XIP-3901-UC 1.1 and XIP-3901-DC 1.0
13-03065-010-AC-M00	2018-11-23	XIP-3901-FS 1.0 release
13-03065-010-AD-M00	2019-02-15	Improved HDR settings and options New rear panel: XIP-3901-3+DRP-HD
13-03065-010-AE-M00	2020-01-24	Improved HDR settings and options: <ul style="list-style-type: none"> • Support of HDR BBC LUTs • Support of HDR Custom LUTs • Possibility to force a new VPID • HLG and PQ Test Pattern Network: <ul style="list-style-type: none"> • New Bridged network interface through the frame • DHCP • LLDP • Network settings and statuses on local menu XIP-3901-DC: <ul style="list-style-type: none"> • DC1 SDI output duplicated on OUT2, 3, 4 • DC2 SDI output duplicated on OUT6, 7, 8 • On Quad Link 3G SDI inputs, possibility to select audio and metadata source XIP-3901-FS: <ul style="list-style-type: none"> • Transport of audio on link 2, 3, 4 in Quad Link 3G – 2SI/Square Operation mode.
13-03065-010-AF-M00	2020-02-06	Documented a card upgrade procedure to add and select a card application.
13-03065-010-AG-M00	2020-04-09	Documented the XIP-3901-UDC-IP V1.0 application.
13-03065-010-AH-M00	2020-06-18	Documented the XIP-3901-GB-IP application.

Document Number	Publication Date	Notes
13-03065-010-AI-M00	2020-07-31	<p>Documented the XIP-3901-UDC-IP V1.1 application update. Added Support for:</p> <ul style="list-style-type: none"> • Processing of common film rates 23.98p and 29.97p Hz to and from 59.94 Hz material. • Colorimetry and TCS information displayed/set at IP Receivers end • Time-code selection processing and re-generation either directly from the PTP source or a 2110-40 stream. • Video processing toolset: <ul style="list-style-type: none"> ○ Proc-Amp (Luma/Chroma gain, Black, Hue) ○ Color Corrector (RGB Gain, Offset & Gamma) ○ Gamut Legalization ○ Detail Horizontal and Vertical enhancer support on down-converted paths. <p>Documented the XIP-3901-UC/DC/FS V2.1.0: Support for BBC LUTs v1.4.</p>

Copyright and Trademark Notice

Copyright © 2018 to 2020, Grass Valley Canada. All rights reserved.

Belden, Belden Sending All The Right Signals, and the Belden logo are trademarks or registered trademarks of Belden Inc. or its affiliated companies in the United States and other jurisdictions. Grass Valley, Miranda, XIP-3901, iControl, and Densité are trademarks or registered trademarks of Grass Valley Canada. Belden Inc., Grass Valley Canada, and other parties may also have trademark rights in other terms used herein.

Product Patents

This product may be protected by one or more patents. For further information, please visit:

www.grassvalley.com/patents/

Terms and Conditions

Please read the following terms and conditions carefully. By using the XIP-3901 documentation, you agree to the following terms and conditions.

Grass Valley hereby grants permission and license to owners of XIP-3901 to use their product manuals for their own internal business use. Manuals for Grass Valley products may not be reproduced or transmitted in any form or by any means, electronic or mechanical, including photocopying and recording, for any purpose unless specifically authorized in writing by Grass Valley.

A Grass Valley manual may have been revised to reflect changes made to the product during its manufacturing life. Thus, different versions of a manual may exist for any given product. Care should be taken to ensure that one obtains the proper manual version for a specific product serial number.

Information in this document is subject to change without notice and does not represent a commitment on the part of Grass Valley.

Warranty information is available in the Support section of the Grass Valley website (www.grassvalley.com).

Electrostatic Discharge (ESD) Protection



Electrostatic discharge occurs when electronic components are improperly handled and can result in intermittent failure or complete damage, adversely affecting an electrical circuit. When you remove and replace any card from a frame, always follow ESD-prevention procedures:

- Ensure that the frame is electrically connected to earth ground through the power cord or any other means if available.
- Wear an ESD wrist strap, ensuring that it makes good skin contact. Connect the grounding clip to an *unpainted surface* of the chassis frame to safely ground unwanted ESD voltages. If no wrist strap is available, ground yourself by touching the *unpainted* metal part of the chassis.
- For safety, periodically check the resistance value of the antistatic strap, which should be between 1 and 10 megohms.
- When temporarily storing a card, make sure it is placed in an ESD bag.
- Cards in an earth-grounded metal frame or casing do not require any special ESD protection.

Recycling

Visit www.grassvalley.com for recycling information.

Certification and Compliance

Safety of Laser Modules



This equipment incorporates modules containing Class 1 lasers. These modules are certified by the manufacturer to comply with:

- IEC/EN 60825-1 Safety of laser products
- IEC 60950-1 Safety of information technology equipment

Restriction on Hazardous Substances (RoHS)

XIP-3901		有毒有害物质或元素 (Toxic or Hazardous Substances and Elements)					
部件名称Part name	铅 (Pb)	汞(Hg)	镉(Cd)	六价铬 (Cr6)	多溴联苯 (PBB)	多溴二苯 (PBDE)	
电缆及电缆组件Cables and Cable Assemblies	O	O	O	O	O	O	
电路模块 Circuit Modules	X	O	O	O	O	O	
组装风扇 Fan Assemblies	X	O	O	O	O	O	
XIP-3901-3+DRP		有毒有害物质或元素 (Toxic or Hazardous Substances and Elements)					
部件名称Part name	铅 (Pb)	汞(Hg)	镉(Cd)	六价铬 (Cr6)	多溴联苯 (PBB)	多溴二苯 (PBDE)	
电路模块 Circuit Modules	X	O	O	O	O	O	

O: 表示该有毒有害物质在该部件所有均质材料中的含量均在SJ/T 11363-2006规定的限量要求以下。
O: Indicates that this toxic or hazardous substance contained in all of the homogeneous materials for this part is below the limit requirement in SJ/T11363-2006.

X: 表示该有毒有害物质至少在该部件的某一均质材料中的含量超出SJ/T 11363-2006规定的限量要求。
X: Indicates that this toxic or hazardous substance contained in at least one of the homogeneous materials for this part is above the limit requirement in SJ/T11363-2006.

技术条款解释：
此声明所依据之数据由Grass Valley环境管理部门向我们的部件供应商获取。Grass Valley 公司相信此信息的正确性，但由于数据来源于公司外部，我们无法保证它的完整和准确。所有这些特性可能在未获通知的情况下更改。
Technical explanations:
This statement is based on the information provided by our suppliers and collected through Grass Valley's environmental management system. Grass Valley believes this environmental information to be correct but cannot guarantee its completeness or accuracy as it is based on data received from sources outside our company. All specifications are subject to change without notice.

Electromagnetic Compatibility



This equipment has been tested for compliance with FCC Part 15, Subpart B requirements for Class A digital devices.

NOTE: This equipment has been tested and found to comply with the limits for a Class A digital device, pursuant to Part 15 of the FCC Rules. These limits are designed to provide reasonable protection against harmful interference when the equipment is operated in a commercial environment. This equipment generates, uses, and can radiate radio frequency energy and, if not installed and used in accordance with the instruction manual, may cause harmful interference to radio communications. Operation of this equipment in a residential area is likely to cause harmful interference, in which case the user will be required to correct the interference at his own expense.



This equipment has been tested and found to comply with the requirements of the EMC directive 2004/108/CE:

- EN 55022 Class A radiated and conducted emissions
- EN 61000-3-2 Harmonic current emission limits
- EN 61000-3-3 Voltage fluctuations and flicker limitations
- EN 61000-4-2 Electrostatic discharge immunity
- EN 61000-4-3 Radiated electromagnetic field immunity – RF
- EN 61000-4-4 EFT immunity
- EN 61000-4-5 Surge immunity
- EN 61000-4-6 Conducted immunity
- EN 61000-4-8 EMP immunity
- EN 61000-4-11 Voltage dips, short interruptions and voltage variations immunity

Table of Contents

- 1 Introduction to the XIP-3901 Agile SDI/IP Processing Platform 9**
- 2 Applications 10**
 - 2.1 XIP-3901 -UC / -DC / -FS SDI Applications 10
 - 2.2 XIP-3901-UDC-IP Applications 13
 - 2.3 XIP-3901-GB-IP Application 17
 - 2.4 Optional HDR Processing 20
- 3 Front Card-edge Interface 20**
- 4 Installation 21**
 - 4.1 Installing the Rear Connector Panel 21
 - 4.2 Installing the XIP-3901 Card 21
 - 4.3 Rear Connector Panel 22
 - 4.3.1 Image of the Rear Connector Panel 22
 - 4.3.2 Summary of Rear Panel Connections 22
 - 4.3.3 Details of Rear Panel Connections 23
- 5 User Interface 27**
 - 5.1 Control Methods 27
 - 5.2 Card-edge Status LED 27
- 6 Local Control Using the Densité Frame Control Panel 30**
- 7 Card Upgrade 31**
 - 7.1 Starting iControl Solo 31
 - 7.2 Downloading new XIP applications 31
 - 7.3 Installing new applications on the XIP-3901 31
 - 7.4 Opening the XIP-3901 Panel 34
- 8 iControl System User Interface 36**
 - 8.1 XIP-3901 Card Application Configuration 42
- 9 Configuring the XIP-3901-UC / -DC / -FS Applications Using iControl 43**
 - 9.1 Video Input/Output Panel (XIP-3901-UC) 43
 - 9.1.1 Input/Output Config Tab 43
 - 9.1.2 Timing Tab 45
 - 9.1.3 Deglitcher Tab 47
 - 9.1.4 De-interlacer Tab 48
 - 9.2 Video Input/Output Panel (XIP-3901-DC) 49
 - 9.2.1 Input/Output Config Tab 49
 - 9.2.2 Timing Tab 51
 - 9.2.3 Deglitcher Tab 53
 - 9.3 Video Input/Output Panel (XIP-3901-FS) 54
 - 9.3.1 Input/Output Config Tab 54
 - 9.3.2 Timing Tab 57
 - 9.3.3 Deglitcher Tab 61
 - 9.4 Clean Switch Regions and Examples 62
 - 9.5 HDR Panel 65
 - 9.5.1 UC1&2 / DC1&2 / FS1&2 Tabs 65
 - 9.5.2 Custom LUTs Tab 68

9.6	Reference Panel	69
9.7	Test Panel	71
9.8	Network Panel.....	73
9.9	Options Panel.....	75
10	Configuring the XIP-3901-UDC-IP Application Using iControl	76
10.1	Network Panel.....	76
10.2	PTP Panel	81
10.3	NMOS Panel	83
10.4	Receivers Panel.....	85
10.5	Senders Panel.....	90
10.6	Video Panel.....	93
10.7	HDR Panel	101
10.8	Metadata Panel.....	105
10.9	Audio Panel.....	108
10.10	Test Panel	117
10.11	Options Panel.....	118
11	Configuring the XIP 3901-GB-IP Application Using iControl	120
11.1	Network Panel.....	120
11.2	PTP Panel	120
11.3	NMOS Panel	120
11.4	Receivers Panel.....	121
11.5	Senders Panel.....	126
11.6	Video Panel.....	128
11.7	Metadata Panel.....	129
11.8	Test Panel.....	129
12	Common Configuration Panels to all XIP-3901 Applications	130
12.1	Factory/Presets Panel.....	130
12.1.1	User Presets	131
12.1.2	Load Factory button	132
12.1.3	Profiles	133
12.2	Alarm Config Panel	136
12.3	Info Panel	139
12.4	Application Panel	141
13	Fan Replacement	143
13.1	Required Materials	143
13.2	Procedure.....	143
14	Specifications.....	145
15	Contact Us	147
	Grass Valley Technical Support.....	147
	Corporate Head Office	147
APPENDIX A – Local Menu		148
APPENDIX B – Installing the Optical Interface.....		149
APPENDIX C: BBC HLG Look-Up Table		151

1 Introduction to the XIP-3901 Agile SDI/IP Processing Platform

The Densité 3+ XIP-3901 from Grass Valley, a Belden Brand, is a new agile processing platform that focuses on high-quality live production for HD, 1080p, 4K UHD and HDR. This platform is a bridge for the hybrid world, consisting of today’s proven SDI technology and the latest IP connectivity.



Figure 1–Densité 3+ and XIP-3901

To meet customers’ needs both now and in the future, the XIP-3901 uses a flexible “virtualized” hardware platform. Based on a powerful FPGA engine, the XIP-3901 can be reconfigured with software updates for different applications as requirements change.

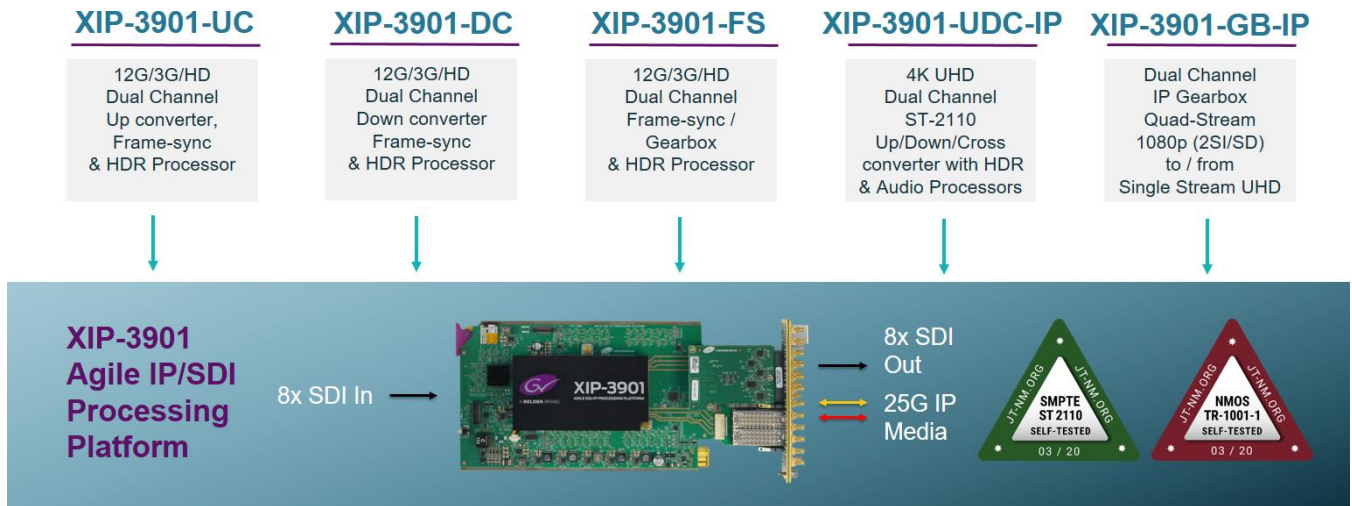

Figure 2– XIP-3901 Application Agility Evolution

2 Applications

The XIP-3901 card supports a number of processing applications that can be individually activated on this card, thereby allowing the card to be redeployed for other uses. See 12.4 - Application Panel on page 141. This user manual describes the following applications only:

Application	See for an overview description
XIP-3901-UC, XIP-3901-DC, or XIP-3901-FS	2.1 - XIP-3901 -UC / -DC / -FS SDI Applications on page 10.
XIP-3901-UDC-IP	2.2 - XIP-3901-UDC-IP Applications on page 13.
XIP-3901-GB-IP	2.3 - XIP-3901-GB-IP Application on page 17.

2.1 XIP-3901 -UC / -DC / -FS SDI Applications

The applications for the XIP-3901 agile IP/SDI processing platform provides full functionality of up/down/frame sync-gearbox processing capability delivered through three applications that allow your live productions — either from trucks, venues or stadiums — to make the most of the new 4K UHD and HDR formats. This includes playout channels where output of a 4K UHD HDR channel needs to be downconverted for an HD SDR simulcast version.

The XIP-3901 agile processing platform with the rear panel XIP-3901-3+DRP-H comes with all the 12G/Quad Link 3G/3G/HD HD-BNC SDI connectivity to support two 4K UHD processing paths with the XIP-3901-UC/DC/FS applications. The rear panel XIP-3901-3+DRP is also available for DIN SDI connectivity for backward compatibility, but Grass Valley is now promoting the HD-BNC as the miniature SDI connector going forward. The XIP-3901 is installed in a Densité modular frame. Due to advanced processing capabilities and power requirements, the XIP-3901 is supported only by the Densité 3+ FR1 and FR4 frames.

Densité 3+ XIP-3901-UC is an application that provides a dual-channel 12G/Quad Link 3G/3G/HD-SDI upconverter, which is designed to synchronize, upconvert and process HD and 3G 1080p signals for both 1080p and 4K UHD 2160p broadcast production. The XIP-3901-UC application features broadcast-quality scalers, motion-adaptive de-interlacers and color space conversions between ITU-R BT.709 and ITU-R BT.2020.

Densité 3+ XIP-3901-DC is an application that provides a dual-channel 12G/Quad Link 3G/3G/HD downconverter, which is designed to synchronize, downconvert and process 4K UHD 2160p and 1080p for both 1080p and HD broadcast production. The XIP-3901-DC application features broadcast-quality down-scalers, interlacers and color space conversions between ITU-R BT.2020 and ITU-R BT.709.

Densité 3+ XIP-3901-FS is an application that provides a dual-channel 12G/Quad Link 3G/3G/HD frame synchronizer with gearbox functionality, which is designed to synchronize and convert color space between ITU-R BT.2020 and ITU-R BT.709 in 4K UHD, 1080p and HD broadcast productions.

All applications will delay 12G/3G/HD embedded audio and metadata to maintain synchronization with video. The optional HDR processor, XIP-3901-UDC-HDR, allows conversion between SDR and HDR formats, supporting HLG (ITU-R BT.2100), PQ (ITU-R BT.2100) and S-Log3/S-Gamut3 formats, with conversion between formats. In addition to the Grass Valley LUTs, you can select BBC LUTs v1.4 or you can choose your own Custom LUTs compliant to Adobe cube file v1.0 for fully flexible HDR processing.

Based on the proven Densité modular framework of over 100 cards, the flexible, space-efficient XIP-3901 agile processing platform can accommodate a gradual adoption of different production elements into 1080p and 4K UHD broadcasting workflows — and it enables dual HDR/SDR production — all while protecting your investment in installed equipment. With flexibility to configure up to 12 XIP-3901 dual-channel processing applications per Densité 3+ FR4 frame, the Densité platform scales to a market-leading density of 24 4K UHD processors with HDR conversions in a 4 RU frame. This means space and cost-efficient scaling for today and tomorrow.

2.1.1 XIP-3901 -UC / -DC / -FS Key Features

- Independent dual processing channels
- 12G 2160p, 3G 1080p and HD 1080i/720p input/output (depending on application)
- 12G-SDI Mode 1 and Type 1
- Quad Link 3G in 2SI and Square Division
- 3G Level A & Level B Dual-Link
- High-quality scaler and advanced de-interlacer on XIP-3901-UC
- High-quality downscaler and interlacer on XIP-3901-DC
- 12G-SDI to/from Quad Link 3G in 2SI/Square Division on XIP-3901-FS
- Integrated frame synchronizer (freeze to last valid frame/field on error)
- Minimum processing delay mode available on XIP-3901-FS
- Audio/video deglitcher to handle video hot switches at the input
- Broadcast-quality color conversion (between ITU-R BT.709 and ITU-R BT.2020)
- SDR/HDR optional processing support HLG, PQ, and S-Log3/S-Gamut3 formats
- Selection between GV LUTs, BBC LUTs v1.4, or User Custom LUTs
- External reference or URS frame reference
- Embedded audio and metadata delay and synchronization
- Individual application licensed, purchased as needed
- Rapid switching between applications

2.1.2 XIP-3901 -UC / -DC / -FS Supported Video Formats

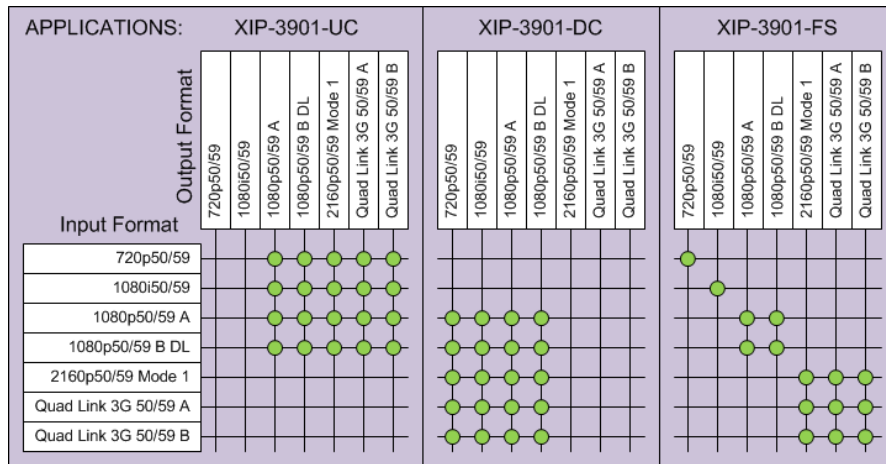

Figure 3—Supported Video Formats for XIP-3901 -UC / -DC / -FS Applications

Note: 50/59.94 Hz frame rate conversion is not supported.

2.1.3 Functional Block Diagrams

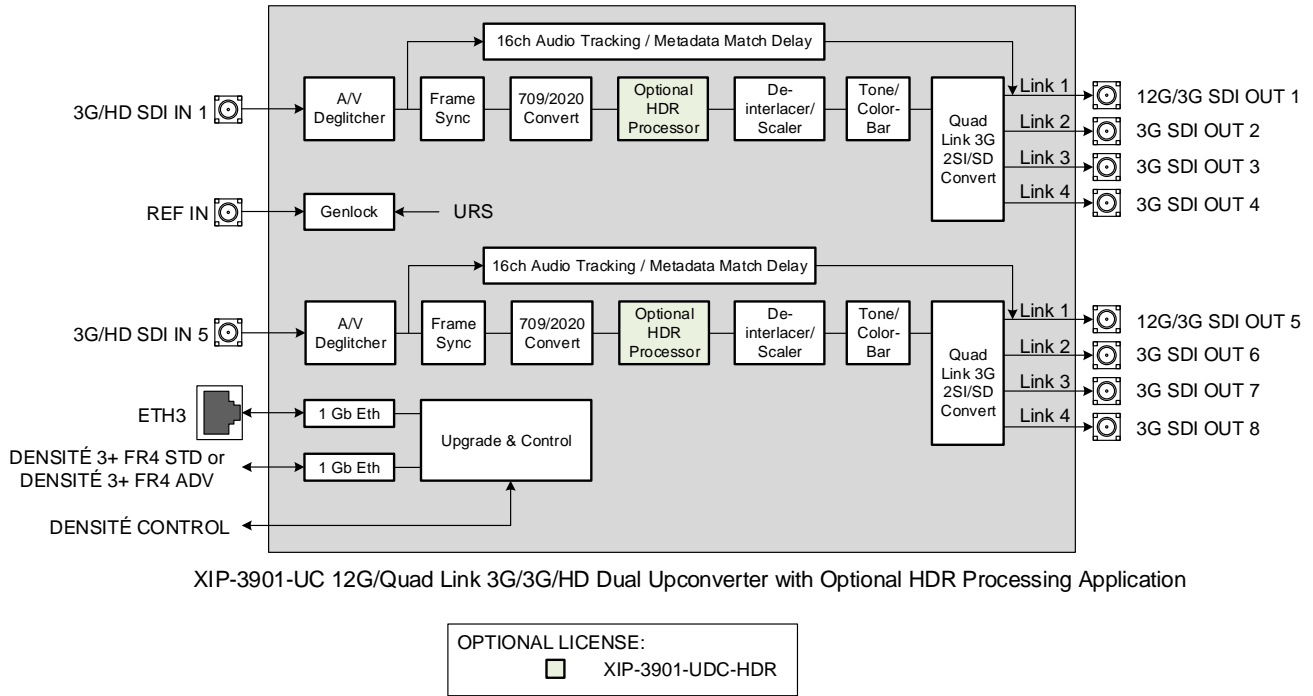

Figure 4–XIP-3901-UC Functional Block Diagram

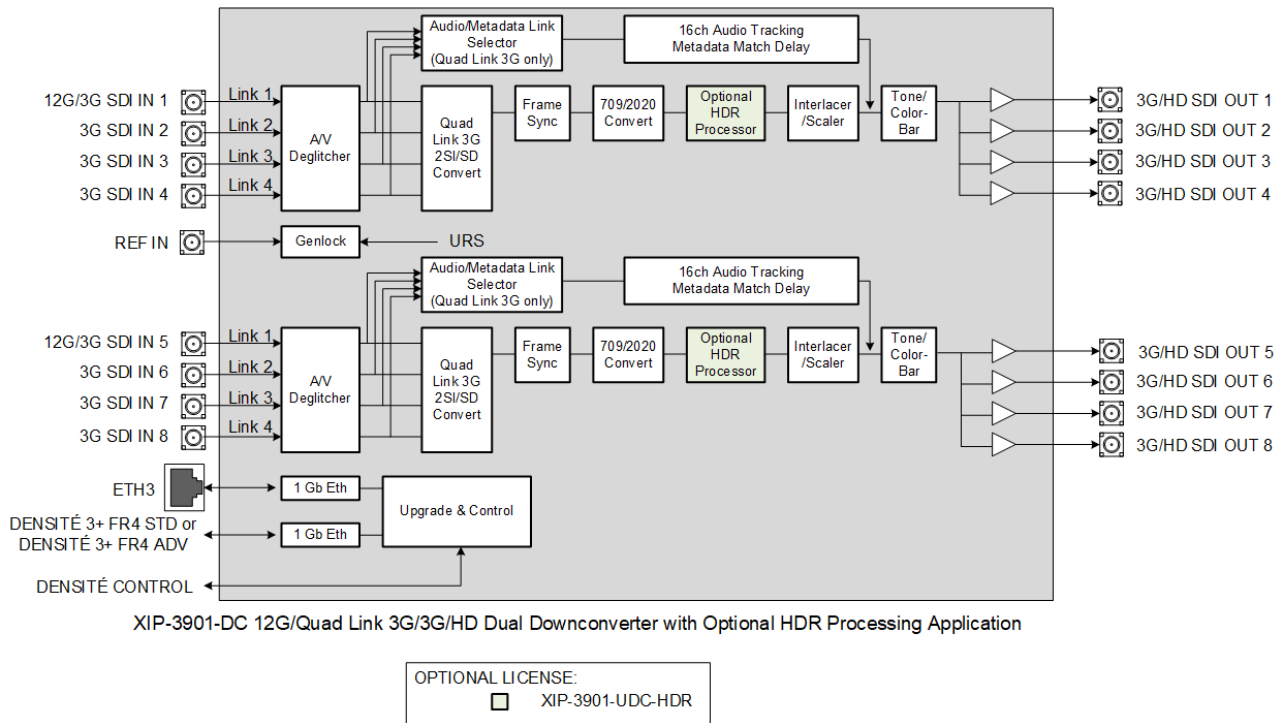

Figure 5–XIP-3901-DC Functional Block Diagram

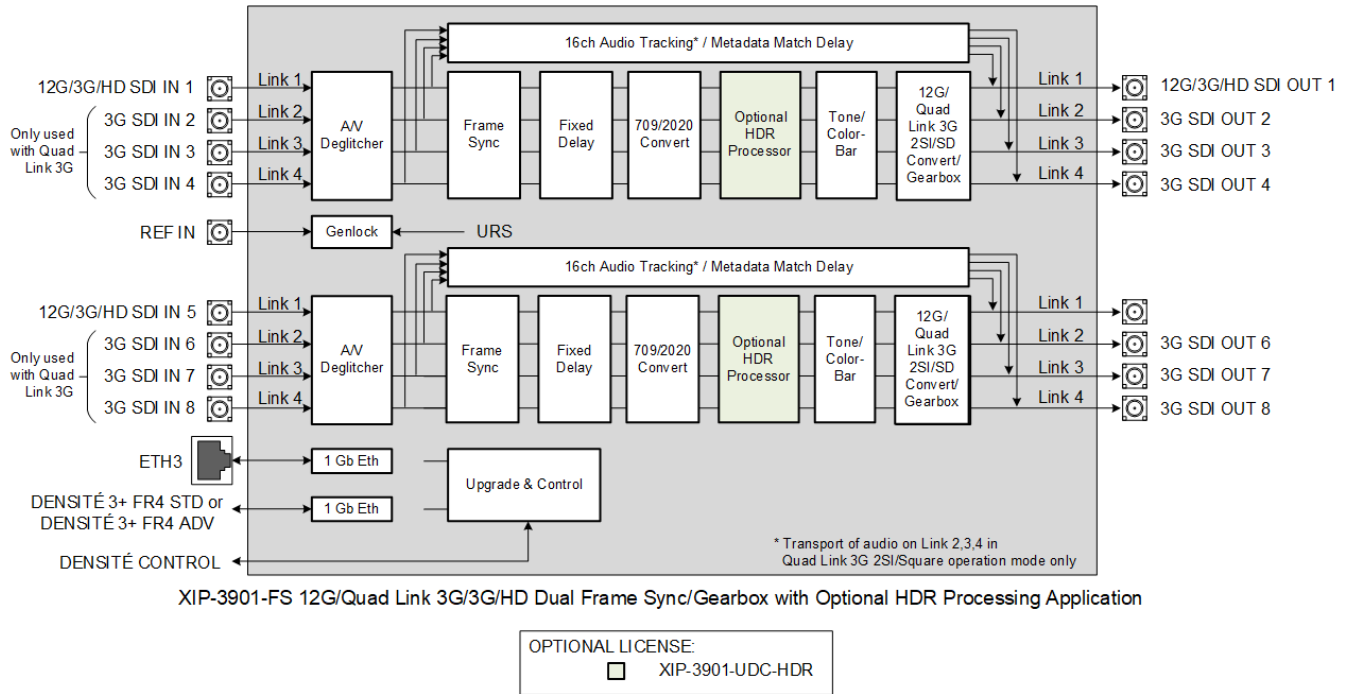

Figure 6–XIP-3901-FS Functional Block Diagram

2.2 XIP-3901-UDC-IP Applications

The XIP-3901-UDC-IP is a dual-channel 4K UHD broadcast quality format converter with optional HDR and Audio processor supporting IP with dual 25GbE I/O. Based on open standards, this IP edge processing application is compliant to SMPTE ST 2110 suite of standards and JT-NM TR-1001 technical recommendation for easy integration in a broadcast network production environment as confirmed by our successful participation in **JT-NM Tested** events in August 2019 and March 2020.



The **XIP-3901-UDC-IP** integrates all the video processing function to perform up/down/cross-conversion needed to maintain the chosen output formatting, irrespective of whether the input is HD 720p, 1080i, 1080p or UHD 2160p. High quality up/down/cross-conversion is performed at both 50 and 59.94 Hz, based on multiple sophisticated processing technologies. These include detail enhancement, pixel-based de-interlacing, and advanced motion adaptive de-interlacing and anti-ringing.

The XIP-3901-UDC-IP supports processing of common film rates 23.98p and 29.97p Hz to and from 59.94 Hz material and offers timecode selection either directly from the PTP source or the SMPTE ST 2110-40 stream for processing and regeneration.

The optional HDR processor, **XIP-3901-UDC-HDR**, allows conversion between SDR and HDR formats and wide color gamut BT.709 and BT.2020, supporting HLG (ITU-R BT.2100), PQ (ITU-R BT.2100), and SLog3/SGamut3 formats. In addition to the Grass Valley LUTs, you can select BBC LUTs v1.4 or you can choose your own Custom LUTs compliant to Adobe cube file v1.0 for fully flexible HDR processing. The HDR processor operates in full 10-bit video signals with the ability to pass sub-blacks and super-whites in SMPTE Narrow video signals and the support of SMPTE Full in PQ and S-Log3 signals.

Four streams of 2110-30/31 audio conforming to Level A and Level C is supported per video channel, giving a total of 228 channels of audio with automatic delay to keep lip sync. **The XIP-3901-UDC-AUD** option gives advanced processing control with audio level, delay, up & down-mixing, and shuffling for additional flexibility.

The XIP-3901-UDC-IP can be configured, controlled and monitored by GV Orbit from Grass Valley taking advantage of its many features and functions specifically crafted to make IP easy. It can also be configured and controlled from iControl systems.

Based on the proven Densité modular framework of over 100 cards, the flexible, space-efficient XIP-3901 agile processing platform can accommodate a gradual adoption of different production elements into 1080p and 4K UHD broadcasting workflows — and it enables dual HDR/SDR production — all while protecting your investment in installed equipment. With flexibility to configure up to 12 XIP-3901 dual-channel processing applications per Densité 3+ FR4 frame, the Densité platform scales to a market-leading density of 24 4K UHD processors with HDR conversions in a 4 RU frame. This means space and cost-efficient scaling for today and tomorrow.

2.2.1 XIP-3901-UDC-IP Key Features

- Independent dual-channel UHD up/down/cross IP video processor
- ST 2110-20 Video with UHD over single-stream
- ST 2110-21 Wide/Narrow profile receivers and Narrow senders
- ST 2110-30 PCM Audio
- ST 2110-31 AES3 Transparent Transport
- ST 2110-40 Metadata associated with ST 2110-20 video stream
- ST 2022-7 Class A & D seamless protection switching of IP streams.
- ST 2059-1 & -2 Precision Time Protocol with Best Master Clock Algorithm
- NMOS IS-04 discovery and registration with group hint tag support.
- NMOS IS-05 device connection management
- In-band or out-of-band control of NMOS
- Support of DHCP, LLDP and DNS-SD for easy IP configuration
- Video proc features include: gain, offset, hue, horizontal and vertical picture enhancement during downconversion, RGB color corrector, and gamut legalization
- XIP-3901-UDC-HDR option provides HDR conversion supporting both Wide Color Gamut BT.709/ BT.2020 and High Dynamic Range: HLG, PQ and S-Log3.
 - All processing operates in full 10-bit video signals with ability to pass sub-blacks and super-whites in SMPTE narrow video.
 - Choice between Grass Valley conversions algorithms, BBC HLG LUT v1.4 and user defined 3D-LUT support.
 - ITU R BT 2111 HLG/PQ Color bar test patterns
- Four ST 2110-30/31 Level A and C audio stream per processing channels.
- XIP-3901-UDC-AUD option provides 228 channels audio processors with level, delay, up/down mixing and 2:1 mixer/shuffling.
- Dual SFP28 Flexible Ethernet for 25GigE SFP+ cage:
 - **SFP-25G-SR** for short-range multi-mode optical connectors,
 - **SFP-25G-LR** for long range single-mode optical connectors,
 - Active optical cables and optical transceiver.
- Both FEC74 (CL74 Fire Code) and FEC108 (Reed Solomon IEEE) Forward Error Correction are supported.
- GV Orbit for configuration, control and monitoring.

2.2.2 XIP-3901-UDC-IP Supported Video Formats

The XIP-3901-UDC-IP supports the following ST 2110-20 Single-Stream formats. In addition the XIP-3901-UDC-IP supports processing of common film rates 23.98p and 29.97p Hz to and from 59.94 Hz material.

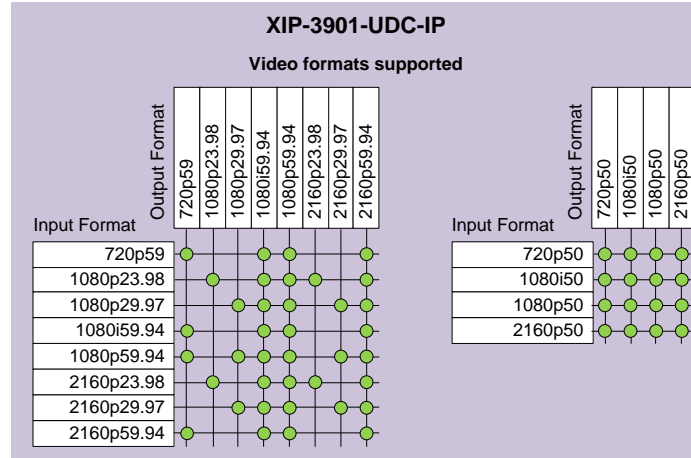

Figure 7–Supported Video Formats for XIP-3901-UDC-IP Applications

2.2.3 Optional XIP-3901-UDC-IP Application Audio processing, Down/Up Mix, Shuffling

The following audio processing features are available with the **XIP-3901-UDC-AUD** option.

- Audio probing (audio presence/ audio type)
- Input mixer
- Upmix
- Downmix
- Fixed delay
- Level & Phase invert
- Output audio: mixer & shuffler

See 9.9 - Options Panel for how to enable this option.

2.2.4 Functional Block Diagram

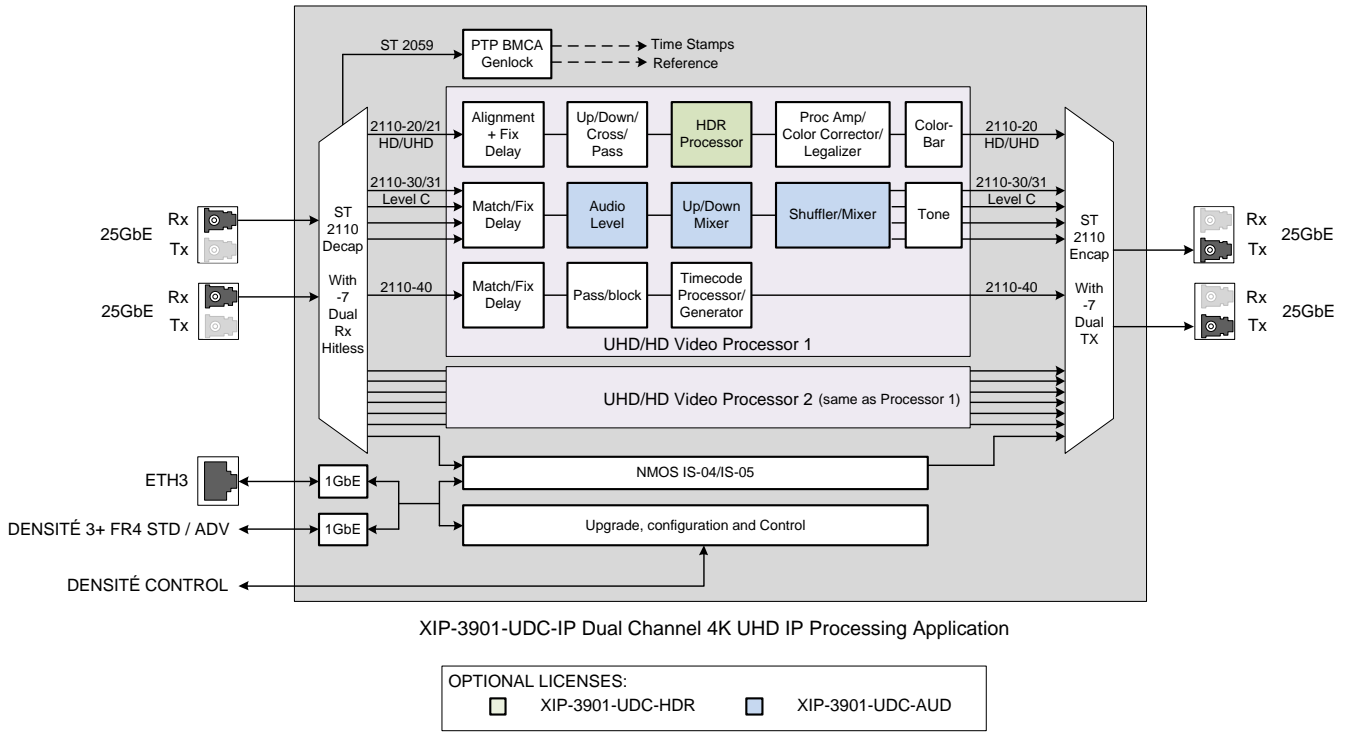
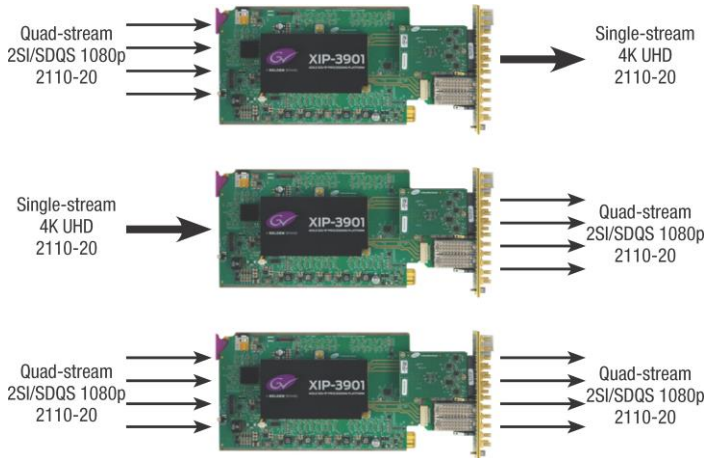

Figure 8 – XIP-3901-UDC-IP Functional Block Diagram

2.3 XIP-3901-GB-IP Application

The XIP-3901-GB-IP is a dual-channel 4K UHD gearbox application for conversion between Quadstream 1080p Two Sample Interleave (2SI) or Square Division Quad Stream (SDQS) and Single-stream 4K UHD supporting IP with dual 25 GbE I/O. Based on open standards, this IP edge gearbox processing application is compliant to the SMPTE ST 2110 suite of standards and JT-NM TR-1001 technical recommendation for easy integration in a broadcast IP network production environment.

The XIP-3901-GB-IP solves 4K UHD production problems with early IP devices implementing Quad-stream 1080p and SMPTE ST 2110-20 recommendations for Single-stream 2160p, which can be a gap when building a complete end-to-end 4K UHD solution.



The XIP-3901-GB-IP also supports four streams of SMPTE ST 2110-30/31 audio conforming to Level A and Level C, as well as one stream of SMPTE ST 2110-40 metadata per channel of IP gearbox.

The XIP-3901-GB-IP is configured, controlled and monitored by GV Orbit, taking advantage of its many features and functions specifically crafted to make IP easy. It can also be configured and controlled from iControl systems.

Based on the proven Densité modular framework with over 80 card types, the flexible, space-efficient XIP-3901 agile processing platform can accommodate a gradual adoption of different production elements into 1080p and 4K UHD broadcasting workflows, all while protecting your investment in installed equipment. With flexibility to configure up to 12 XIP-3901 dual-channel processing applications per Densité 3+ FR4 frame, the Densité platform scales to a density of 24 4K UHD processors in a 4 RU frame. This means space and cost-efficient scaling today and tomorrow.

All the processing applications delivered on the XIP-3901 platform allow live productions, either from trucks, venues, stadiums or broadcast facilities to make the most of new UHD and HDR formats. Packing lots of audio/video processing power in a small form factor means considerable savings in terms of space, power and weight.

2.3.1 XIP-3901-GB-IP Key Features

- Independent dual-channel UHD Gearbox IP video processor
- ST 2110-20 Video with UHD over single and quad-1080p streams
- Supports Two Sample Interleave and Square Division
- ST 2110-21 Wide/Narrow profile receivers and Narrow senders
- ST 2110-30 PCM Audio
- ST 2110-31 AES3 Transparent Transport

- ST 2110-40 Metadata associated with ST 2110-20 video stream
- ST 2022-7 Class A & D seamless protection switching of IP streams.
- ST 2059-1 & -2 Precision Time Protocol with Best Master Clock Algorithm
- NMOS IS-04 discovery and registration with group hint tags support.
- NMOS IS-05 device connection management
- In-band or out-of-band control of NMOS
- Support of DHCP, LLDP and DNS-SD for easy IP configuration
- Four ST 2110-30/31 Level A and C audio streams per processing channel.
- Dual SFP28 Flexible Ethernet for 25GigE SFP+ cage:
 - **SFP-25G-SR** for short-range multi-mode optical connectors,
 - **SFP-25G-LR** for long range single-mode optical connectors,
 - Active optical cables and optical transceiver.
- Both FEC74 (CL74 Fire Code) and FEC108 (Reed Solomon IEEE) Forward Error Correction are supported.
- GV Orbit for configuration, control and monitoring

2.3.2 XIP-3901-GB-IP Supported Video Formats

The XIP-3901-GB-IP supports the following video formats conversion.

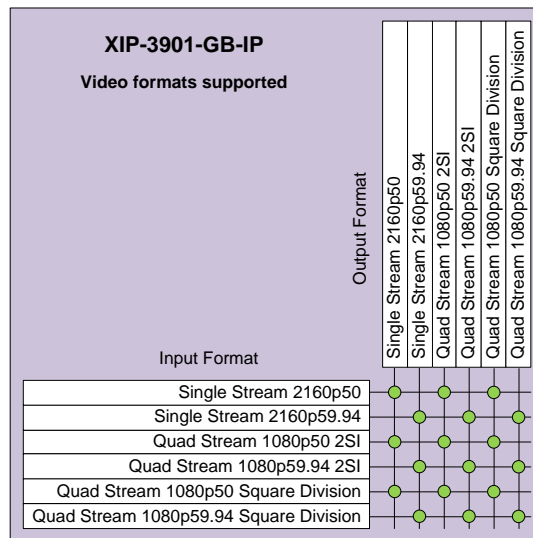
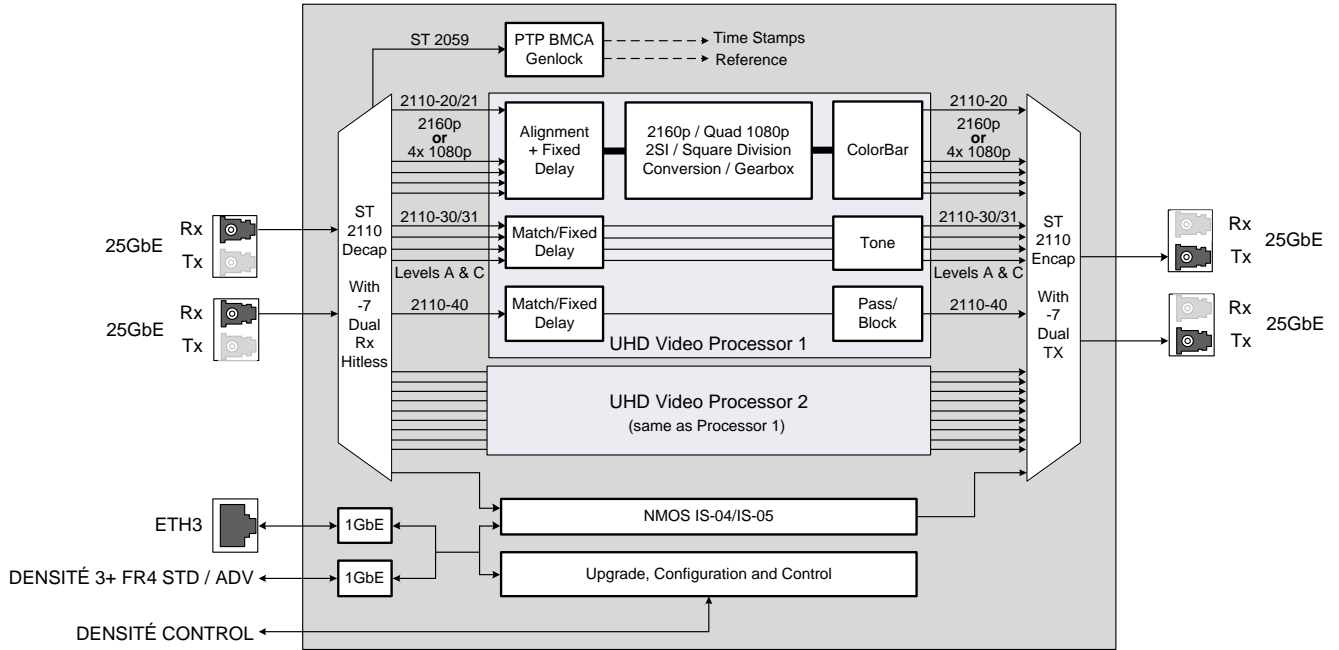

Figure 9—Supported Video Formats for XIP-3901-GB-IP Applications

2.3.3 Functional Block Diagram



XIP-3901-GB-IP Dual Channel 4K UHD Gearbox IP Processing Application

Figure 10 – XIP-3901-GB-IP Functional Block Diagram

2.4 Optional HDR Processing

Optional HDR processing is available for the following applications only:

- XIP-3901-UC / -DC / -FS Application
- XIP-3901-UDC-IP Application

The above applications include ITU-R BT.709 and ITU-R BT.2020 color space conversions. The **XIP-3901-UDC-HDR** option adds HDR/SDR up-mapping and down-mapping capabilities, as summarized in the following table:

GV LUT Conversions	BBC LUT	User Defined LUT
BT. 709 ↔ BT. 2020	BT.709 ↔ HLG BT.2100 SCENE REFERRED	Adobe cube file v1.0 – 33 cube
BT. 709 ↔ HLG BT.2100	BT.709 ↔ HLG BT.2100 DISPLAY REFERRED	BT. 709 ↔ BT. 2020
BT. 709 ↔ PQ ST.2100	HLG BT.2110 ↔ PQ BT.2110	Narrow ↔ Full range
HLG BT.2100 ↔ PQ ST.2100	S-Log3 BT.2020 → HLG BT.2110	
S-Log3/S-Gamut3 → BT. 709		
S-Log3/S-Gamut3 → HLG BT.2100		
S-Log3/S-Gamut3 → PQ BT.2100		

And ITU R BT 2111 HLG/PQ Color bar test patterns

Figure 11– HDR/SDR Up-mapping and Down-mapping Capabilities for XIP-3901-UC / -DC / -FS & XIP-3901-UDC-IP Applications

See 9.9 - Options Panel for how to enable this option.

3 Front Card-edge Interface

The front card-edge of the XIP-3901 incorporates two elements:

- Status LED (see 5.2 - Card-edge Status LED)
- Select button (see 6 - Local Control Using the Densité Frame Control Panel)

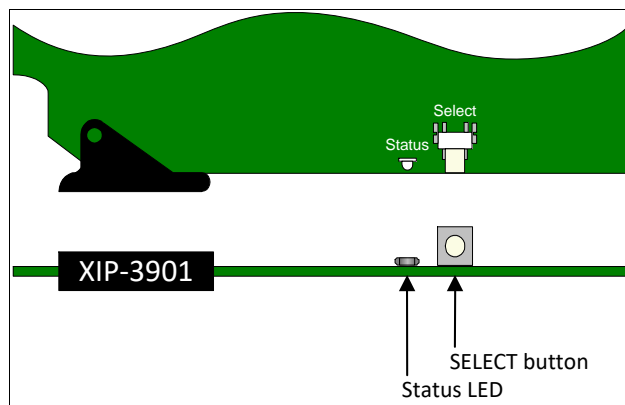

Figure 12–Front Card-edge Layout

4 Installation

4.1 Installing the Rear Connector Panel

Each Grass Valley Densité-series card is associated with a rear connector panel, which must be installed in the Densité frame before the card can be inserted.

The XIP-3901 card is designed to fit into Grass Valley's Densité3+ frames. The following rear connector panels are available:

- XIP-3901-3+DRP: Double rear connector panel for Densité 3+ (DIN connectors)
- XIP-3901-3+DRP-H: Double rear connector panel for Densité 3+ (HD BNC connectors)

See 4.3 - Rear Connector Panel for details about the signal connections available on this panel.

All cards and rear connector panels can be installed with the frame powered on. The card has connectors that plug into a mid-frame motherboard to distribute power and connect to the controller card, as well as a second connector that plugs directly into the rear connector panel for input and output.

To install the connector panel:



The rear connector panel must be installed with the card out of the frame.

1. If a card is installed in the slot for which the rear connector panel is being changed, it must be removed. Tilting the swivel handle on the front of the card to lever the connectors apart, and then use the handle to pull the card straight out of the slot.
2. Remove the existing rear connector panel (either blank or belonging to an existing card that is being changed) by releasing the captive screw(s) at the bottom (Densité3+ or Densité-3+FR4) or on the side (Densité-3+FR1) of the panel.
3. Position the new rear connector panel and secure it in place with the captive screw(s) at the bottom or on the side.

4.2 Installing the XIP-3901 Card

Once a matching rear connector panel is in place, install the XIP-3901 card as follows:

1. Open the front panel of the frame.
2. Slide the XIP-3901 card into the slot and push gently on the handle to seat the connectors.
 - When using a double-slot-width rear panel in a Densité-3+FR1 frame, the card should be inserted into the lower of the two slots.
 - When using a double-slot-width rear panel in a Densité-3+FR4 frame, the card should be inserted into the rightmost of the two slots.

Inserting the card into the wrong slot will not damage the card, but the status LED on the card will flash red to indicate that there is no connection to the rear panel.

3. Close the front panel of the frame.

4.3 Rear Connector Panel

4.3.1 Image of the Rear Connector Panel

The rear connector panel is shown in Figure 13. Details of the inputs and outputs are described below. Note that an application may not use all available inputs and outputs.

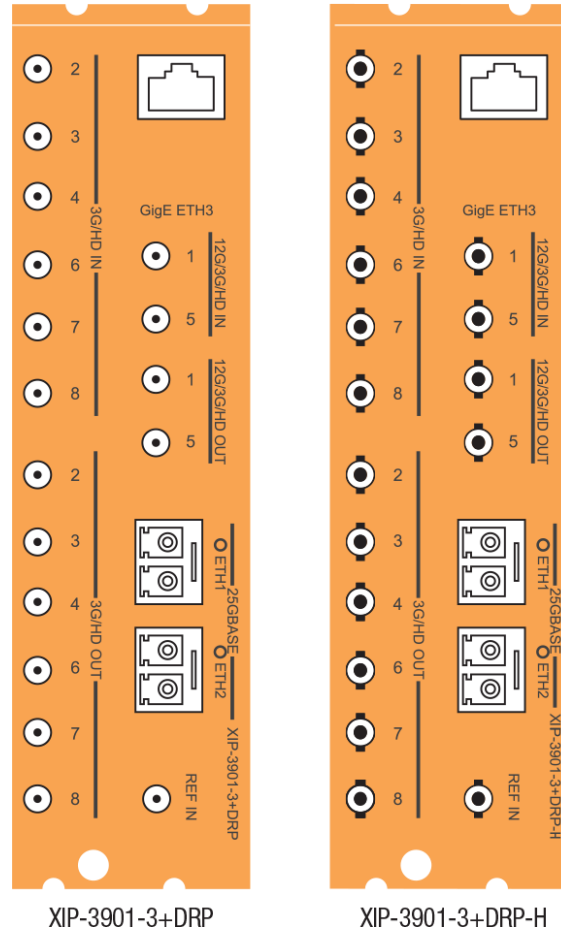

Figure 13–XIP-3901 Rear Panels

4.3.2 Summary of Rear Panel Connections

Connector Nomenclature	Count	XIP-3901-3+DRP Rear Connector Type	XIP-3901-3+DRP-H Rear Connector Type	Used for application
REF IN	1	DIN	HD BNC	XIP-3901-UC / -DC / -FS
3G/HD IN 2 / 3 / 4 / 6 / 7 / 8	6	DIN	HD BNC	XIP-3901 -DC / -FS
12G/3G/HD IN 1 / 5	2	DIN	HD BNC	XIP-3901-UC / -DC / -FS
3G/HD OUT 2 / 3 / 4 / 6 / 7 / 8	6	DIN	HD BNC	XIP-3901-UC / -FS
12G/3G/HD OUT 1 / 5	2	DIN	HD BNC	XIP-3901-UC / -DC / -FS
25G BASE ETH1 / ETH2	2	SFP+	SFP+	XIP-3901-UDC-IP XIP-3901-GB-IP
GigE ETH3	1	RJ-45	RJ-45	XIP-3901-UC / -DC / -FS XIP-3901-UDC-IP XIP-3901-GB-IP

4.3.3 Details of Rear Panel Connections

REF IN – External reference

Connect an NTSC or PAL reference signal (SMPTE 170M/SMPTE 318M/ITU 624-4 black burst). This is used with the XIP-3901-UC / -DC / -FS applications only.

12G/3G/HD IN – Serial digital 3G/HD Inputs

Connect serial digital video signals, conforming to SMPTE ST 2081 and ST 2082 for 12G input signals, SMPTE 425M for 3G input signals or SMPTE 292M for HD input signals, to the connectors specified in the tables below. This is used with the XIP-3901-UC / -DC / -FS applications only.

Connector Nomenclature	XIP-3901-UC Input Signal
12G/3G/HD IN 1	UC1 3G/HD SDI
3G/HD IN 2	Not used
3G/HD IN 3	Not used
3G/HD IN 4	Not used
12G/3G/HD IN 5	UC2 3G/HD SDI
3G/HD IN 6	Not used
3G/HD IN 7	Not used
3G/HD IN 8	Not used

Connector Nomenclature	XIP-3901-DC Input Signal
12G/3G/HD IN 1	DC1 Quad Link 3G - Link 1/12G/3G
3G/HD IN 2	DC1 Quad Link 3G - Link 2
3G/HD IN 3	DC1 Quad Link 3G - Link 3
3G/HD IN 4	DC1 Quad Link 3G - Link 4
12G/3G/HD IN 5	DC2 Quad Link 3G - Link 1/12G/3G
3G/HD IN 6	DC2 Quad Link 3G - Link 2
3G/HD IN 7	DC2 Quad Link 3G - Link 3
3G/HD IN 8	DC2 Quad Link 3G - Link 4

Connector Nomenclature	XIP-3901-FS Input Signal
12G/3G/HD IN 1	FS1 Quad Link 3G - Link 1/12G/3G/HD
3G/HD IN 2	FS1 Quad Link 3G - Link 2
3G/HD IN 3	FS1 Quad Link 3G - Link 3
3G/HD IN 4	FS1 Quad Link 3G - Link 4
12G/3G/HD IN 5	FS2 Quad Link 3G - Link 1/12G/3G/HD
3G/HD IN 6	FS2 Quad Link 3G - Link 2
3G/HD IN 7	FS2 Quad Link 3G - Link 3
3G/HD IN 8	FS2 Quad Link 3G - Link 4

12G/3G/HD OUT– Serial digital 12G/3G/HD outputs

SDI output signals appear on the rear panel connectors as shown in the table, conforming to SMPTE ST 2081 and ST 2082 for 12G output signals, SMPTE 425M for 3G output signals or SMPTE 292M for HD output signals. This is used with the XIP-3901-UC / -DC / -FS applications only.

Connector Nomenclature	XIP-3901-UC Output Signal
12G/3G/HD OUT 1	UC1 Quad Link 3G - Link 1/12G/3G
3G/HD OUT 2	UC1 Quad Link 3G - Link 2
3G/HD OUT 3	UC1 Quad Link 3G - Link 3
3G/HD OUT 4	UC1 Quad Link 3G - Link 4
12G/3G/HD OUT 5	UC2 Quad Link 3G - Link 1/12G/3G
3G/HD OUT 6	UC2 Quad Link 3G - Link 2
3G/HD OUT 7	UC2 Quad Link 3G - Link 3
3G/HD OUT 8	UC2 Quad Link 3G - Link 4

Connector Nomenclature	XIP-3901-DC Output Signal
12G/3G/HD OUT 1	DC1 3G/HD SDI
3G/HD OUT 2	DC1 3G/HD SDI
3G/HD OUT 3	DC1 3G/HD SDI
3G/HD OUT 4	DC1 3G/HD SDI
12G/3G/HD OUT 5	DC2 3G/HD SDI
3G/HD OUT 6	DC2 3G/HD SDI
3G/HD OUT 7	DC2 3G/HD SDI
3G/HD OUT 8	DC2 3G/HD SDI

Connector Nomenclature	XIP-3901-FS Output Signal
12G/3G/HD OUT 1	FS1 Quad Link 3G - Link 1/12G/3G/HD
3G/HD OUT 2	FS1 Quad Link 3G - Link 2
3G/HD OUT 3	FS1 Quad Link 3G - Link 3
3G/HD OUT 4	FS1 Quad Link 3G - Link 4
12G/3G/HD OUT 5	FS2 Quad Link 3G - Link 1/12G/3G/HD
3G/HD OUT 6	FS2 Quad Link 3G - Link 2
3G/HD OUT 7	FS2 Quad Link 3G - Link 3
3G/HD OUT 8	FS2 Quad Link 3G - Link 4

ETH1, ETH2 – 25 GigE on fiber (SFP+)

Transmit and receive video/audio/metadata streams for use with the XIP-3901-UDC-IP and XIP-3901-GB-IP applications only. In addition to video/audio/meta streams, the 25 GigE ports (media ports) support the following protocols:

- PTP
- NMOS IS-04 and IS-05

Note: These connections are not used for SDI applications such as XIP-3901-UC / -DC / -FS.

To install the SFP+ cartridge, see APPENDIX B – Installing the Optical Interface on page 149.

For the XIP-3901-UDC-IP / -GB-IP, the receiver supports:

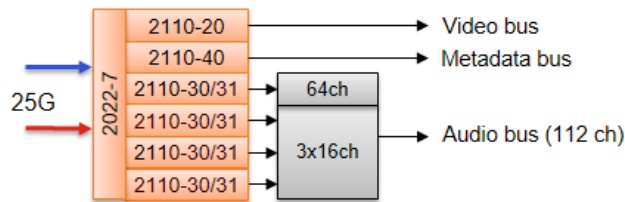

Figure 14 – XIP-3901-UDC-IP / -GB-IP Receiver Overview

- One ST 2110-20/21 Wide/Narrow profile stream supporting:
 - 720p, 1080i, 1080p, 2160p 50/59.94 (single-stream) for the XIP-3901-UDC-IP
 - Quad-stream and single-stream 2160p 50/59.94 for the XIP-3901-GB-IP
- One ST 2110-40 stream associated with video
- Up to 4 x ST 2110-30/31 streams
 - level A (from 1 to 8 channels with 1 ms packet times), and
 - Stream 1: level C (1 to 64 channels with 125 us packet times)
 - Stream 2-4: level C (1 to 16 channels with 125 us packet times)
- Full 2022-7 Class A (10msec) & D (150usec) hitless switching protection

For the XIP-3901-UDC-IP / -GB-IP, the transmitter supports:

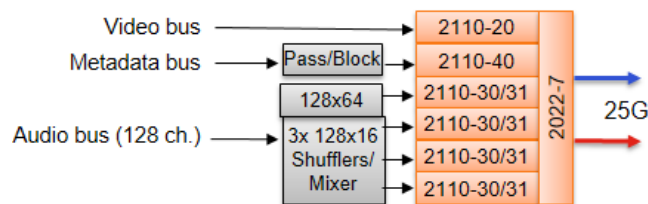

Figure 15 – XIP-3901-UDC-IP / -GB-IP Transmitter Overview

- One ST 2110-20 Narrow profile stream supporting:
 - 720p, 1080i, 1080p, 2160p 50/59.94 (single-stream) for the XIP-3901-UDC-IP
 - Quad-stream and single-stream 2160p 50/59.94 for the XIP-3901-GB-IP
- One ST 2110-40 stream associated with video
- Up to 4 x ST 2110-30/31 streams
 - level A (from 1 to 8 channels with 1 ms packet times), and
 - Stream 1: level C (1 to 64 channels with 125 us packet times)
 - Stream 2-4: level C (1 to 16 channels with 125 us packet times)
- Full 2022-7 switching protection

GigE ETH3 – 1 GigE MANAGEMENT Port (RJ-45)

This network port is used:

- For Densité Upgrade Manager (DUM) upgrades.
- To upload Custom LUTs (for the XIP-3901-UC / -DC / -FS and XIP-3901-UDC-IP applications only).
- For NMOS IS-04 and IS-05 (for the XIP-3901-UDC-IP and XIP-3901-GB-IP applications only).

This connection is not necessary when the XIP-3901 is used with Densité frames that are equipped with Densité 3+FR4 STD or Densité 3+ FR4 ADV frame controllers that are connected to the management IP network.

5 User Interface

5.1 Control Methods

The XIP-3901 card's applications can be controlled in two different ways:

- The local control panel and its buttons can be used to move through a menu of status reports (see 6 - Local Control Using the Densité Frame Control Panel).
- Grass Valley's iControl system must be used to access the card's operating parameters remotely using a convenient graphical user interface (GUI) (see 7 - Card Upgrade on page 31).

5.2 Card-edge Status LED

The status LED is located on the front card-edge of the XIP-3901 and is visible through the front access door of the Densité-3 frame. This LED indicates the status of the XIP-3901 using different colors and by flashing/steady illumination.

The table shows how the various error conditions that can be flagged on the XIP-3901 affect the LED status.

- If a cell is gray, the LED cannot be configured to assume that status.
- If more than one LED status is possible for a particular error condition, the status is configurable. See 12.2 - Alarm Config Panel for details.
- The factory default status, if available, is marked with a ⚙ symbol.

The LED will always show the most severe error status that has been detected and that it is configured to display. In the chart, error severity increases from left to right. Green represents no error/disabled, and flashing red represents the most severe error.

Note: If the LED is flashing yellow, the card has been selected for local control using the Densité frame control panel. See 6 - Local Control Using the Densité Frame Control Panel for details.



Error Condition	XIP-3901 Card		LED Status			
	-UC / -DC / -FS	-UDC-IP -GB-IP	Green	Yellow	Red	Flashing Red
Hardware failure	⚙	⚙				⚙
Wrong or missing rear connector panel	⚙	⚙				⚙
UC1/DC1/FS1 IN1 – No carrier	⚙				⚙	
UC1/DC1/FS1 IN1 – Unsupported	⚙				⚙	
UC1/DC1/FS1 IN1 – Video/TRS error	⚙				⚙	
UC1/DC1/FS1 IN1 – Reference mismatch	⚙				⚙	
DC1/FS1 IN2 – No carrier	⚙				⚙	
DC1/FS1 IN2 – Unsupported	⚙				⚙	
DC1/FS1 IN2 – Video/TRS error	⚙				⚙	
DC1/FS1 IN2 – Reference mismatch	⚙				⚙	
DC1/FS1 IN3 – No carrier	⚙				⚙	
DC1/FS1 IN3 – Unsupported	⚙				⚙	
DC1/FS1 IN3 – Video/TRS error	⚙				⚙	

Error Condition	XIP-3901 Card		LED Status			
	-UC / -DC / -FS	-UDC-IP -GB-IP	Green	Yellow	Red	Flashing Red
DC1/FS1 IN3 – Reference mismatch	✱				✱	
DC1/FS1 IN4 – No carrier	✱				✱	
DC1/FS1 IN4 – Unsupported	✱				✱	
DC1/FS1 IN4 – Video/TRS error	✱				✱	
DC1/FS1 IN4 – Reference mismatch	✱				✱	
DC1/FS1 – Quad Link 3G ALIGN	✱				✱	
UC2/DC2/FS2 IN5 – No carrier	✱				✱	
UC2/DC2/FS2 IN5 – Unsupported	✱				✱	
UC2/DC2/FS2 IN5 – Video/TRS error	✱				✱	
UC2/DC2/FS2 IN5 – Reference mismatch	✱				✱	
DC2/FS2 IN6 – No carrier	✱				✱	
DC2/FS2 IN6 – Unsupported	✱				✱	
DC2/FS2 IN6 – Video/TRS error	✱				✱	
DC2/FS2 IN6 – Reference mismatch	✱				✱	
DC2/FS2 IN7 – No carrier	✱				✱	
DC2/FS2 IN7 – Unsupported	✱				✱	
DC2/FS2 IN7 – Video/TRS error	✱				✱	
DC2/FS2 IN7 – Reference mismatch	✱				✱	
DC2/FS2 IN8 – No carrier	✱				✱	
DC2/FS2 IN8 – Unsupported	✱				✱	
DC2/FS2 IN8 – Video/TRS error	✱				✱	
DC2/FS2 IN8 – Reference mismatch	✱				✱	
DC2/FS2 – Quad Link 3G ALIGN	✱				✱	
UC1/DC1/FS1 – Reference present	✱				✱	
UC1/DC1/FS1 – Reference supported	✱				✱	
UC1/DC1/FS1 – Reference locked	✱				✱	
UC2/DC2/FS2 – Reference present	✱				✱	
UC2/DC2/FS2 – Reference supported	✱				✱	
UC2/DC2/FS2 – Reference locked	✱				✱	
UC1/DC1/FS1 – Color Bars & Tone enabled	✱			✱		
UC2/DC2/FS2 – Color Bars & Tone enabled	✱			✱		
ETH1/ETH2 Link up		✱			✱	
ETH3/FRM Link up	✱	✱	✱			
ETH1/ETH2 SFP Presence		✱			✱	

Error Condition	XIP-3901 Card		LED Status			
	-UC / -DC / -FS	-UDC-IP -GB-IP	Green	Yellow	Red	Flashing Red
ETH1/ETH2 SFP Alarm Rx Power Low/High		✱			✱	
ETH1/ETH2 SFP Alarm Tx Power Low/High		✱			✱	
ETH1/ETH2 SFP Alarm Tx Bias Low/High		✱			✱	
ETH1/ETH2 SFP Alarm Vcc Low/High		✱			✱	
ETH1/ETH2 SFP Alarm Temperature Low/High		✱			✱	
ETH1/ETH2 SFP Warning Temperature Low/High		✱		✱		
PTP Locked		✱			✱	
NMOS registered		✱			✱	
ETH1/ETH2 Video receiver		✱			✱	
ETH1/ETH2 Metadata receiver		✱			✱	
ETH1/ETH2 Audio 1 to 4 receivers		✱			✱	
ETH1/ETH2 Video Redundancy Reconstruction		✱			✱	
ETH1/ETH2 Metadata Redundancy Reconstruction		✱			✱	
ETH1/ETH2 Audio 1 to 4 Redundancy Reconstruction		✱			✱	
ETH1/ETH2 Video sender		✱			✱	
ETH1/ETH2 Metadata sender		✱			✱	
ETH1/ETH2 Audio 1 to 4 sender		✱			✱	
UDC1/UDC2 Input Video		✱			✱	
UDC1/UDC2 Color Bars & Tone enabled		✱		✱		

6 Local Control Using the Densité Frame Control Panel

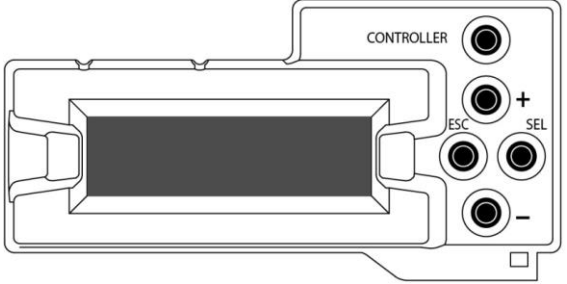
There are two types of local control panels:

Panel type	Frame models	Appearance
Physical	Densité-3+FR1	
Touch-screen	Densité-3+FR4, GV Node	

To assign the local control panel to the XIP-3901:

- Physical panel: Open the front door of the frame to access the panel. Push the [SELECT] button on the front of the card (see 3 - Front Card-edge Interface).
- Touch-screen panel: Use the opening in the frame door to access the panel. On the home screen, touch the icon that corresponds to the card.

The status LED on the XIP-3901 will flash yellow, and the touch-screen status will be yellow for the XIP-3901.

The panel displays two lines of 16 characters and the following four buttons for navigating the menu:

- [+] [-] Navigate menus and modify values.
- [SEL] Accesses the next menu level. When a parameter value is shown, push this button once to modify the value using the [+] and [-] buttons; push it again to confirm the new value.
- [ESC] Cancels parameter value changes that have not been confirmed and reverts the parameter to its former value.

Returns to the previous menu. In the main menu, [ESC] does *not* exit the menu system. To exit, push the [SELECT] button on the card being controlled.

If no controls are operated for 30 seconds, the controller reverts to its normal standby status, and the selected card's status reverts to its normal operating mode.

The complete menu structure is shown in APPENDIX A – Local Menu.

7 Card Upgrade

The XIP-3901 card upgrade can be made through iControl Solo or through the iControl Appserver.

7.1 Starting iControl Solo

To setup the XIP-3901 card, you must have installed on your PC iControl Solo, version 7.51 or higher. To verify the version of iControl Solo installed on your PC, go to the **Help** menu and select **About**, as shown below:

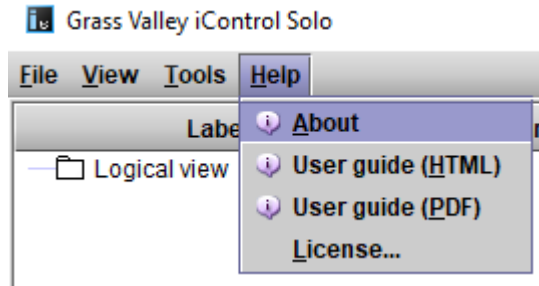

iControl Solo can be downloaded from the Grass Valley website. See [iControl Solos Software](#).

7.2 Downloading new XIP applications

XIP-3901 applications can be downloaded from the Grass Valley support site, under **Downloads for Broadcast Products** and look for **XIP-3901 Agile Modular SDI/IP Processing Platform for Densité 3+** to download latest applications.

This is a .ZIP file. Do not unzip the file for the following procedures.

7.3 Installing new applications on the XIP-3901

To install a new application on an XIP-3901, proceed as follows:

1. In iControl Solo or in iControl Navigator, go in the **Tools** menu and select **Densité Upgrade Manager**, as shown below:

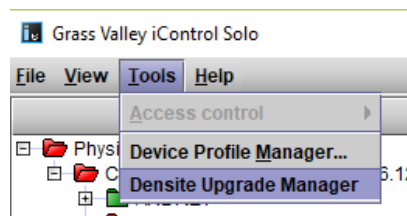

This will start the Densité Upgrade Manager. It may take a few minutes for the frames and cards to populate the window.

In the **Physical View** Tab (1), you will see a list of Densité frames (2), and for each Densité frame is a list of cards installed in the frame's slots (3). You need to expand the tree to see the information, as shown below:

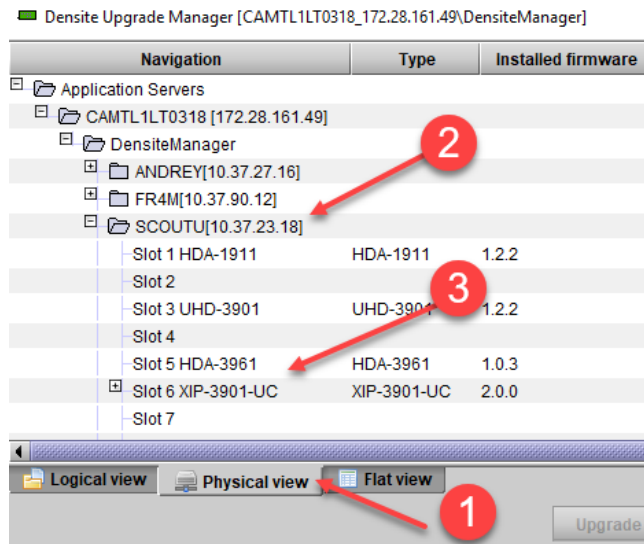

2. Click **Upload files** found at the bottom of the Densité upgrade manager, and in the file browser, select one or more XIP application ZIP files, as shown below. Use <Ctrl> + click to select more than one file.

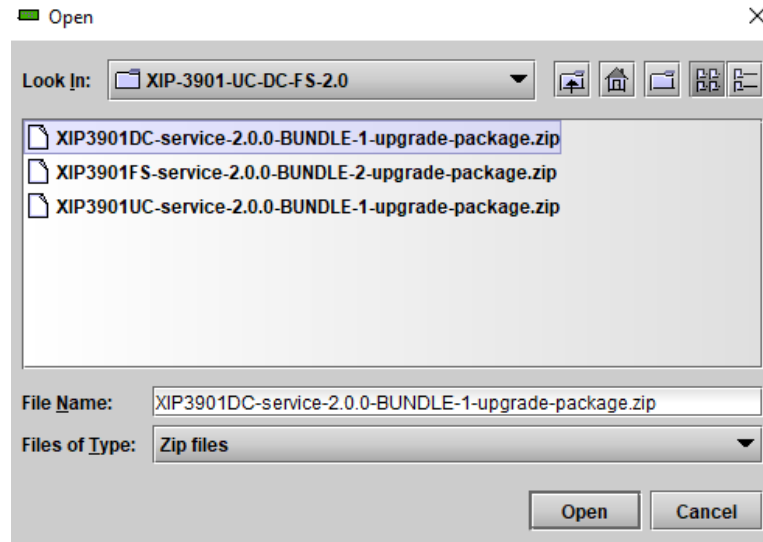

3. Click **Open**.

- Click **Upload** in the Progress dialog:

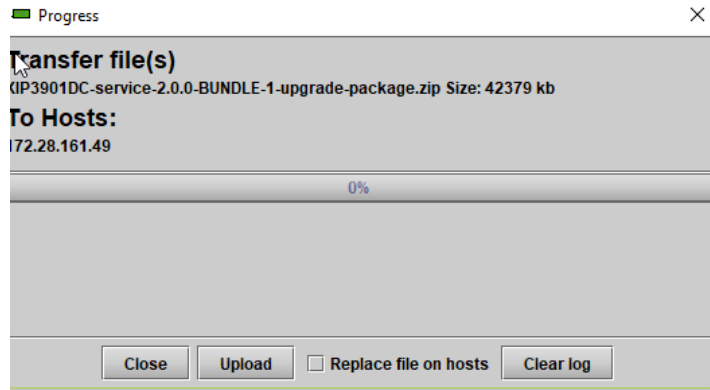

- Once the upload of the application(s) has completed, click **Close**.
- Once complete, click **Clear** at the bottom of the Densité Upgrade Manager window.
- Select the application you want to now use on your XIP-3901 card. Click the **Available package** pulldown for the corresponding XIP-3901 card you want to install/update and select the appropriate bundle for it from the list.

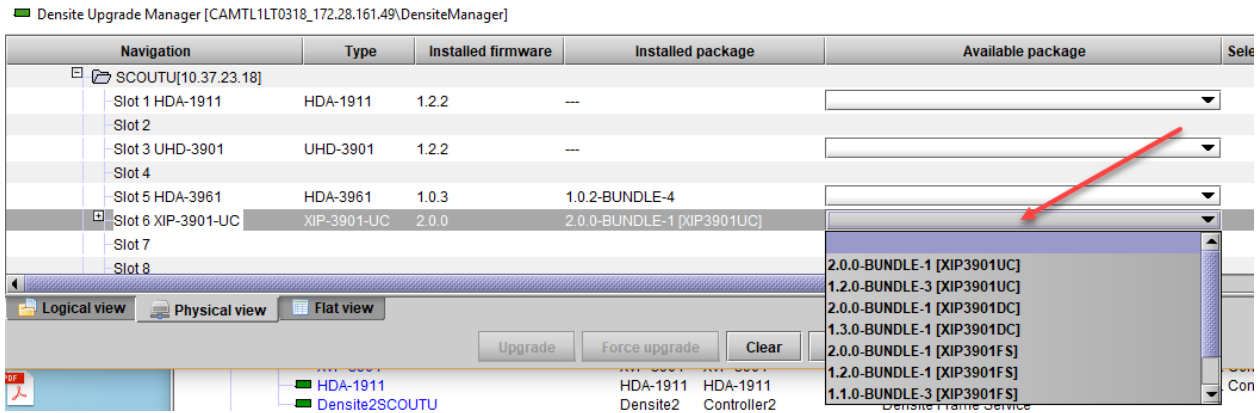

- Click **Upgrade** to launch the card's upgrade process by uploading the firmware into the XIP-3901 card and installing the corresponding application.

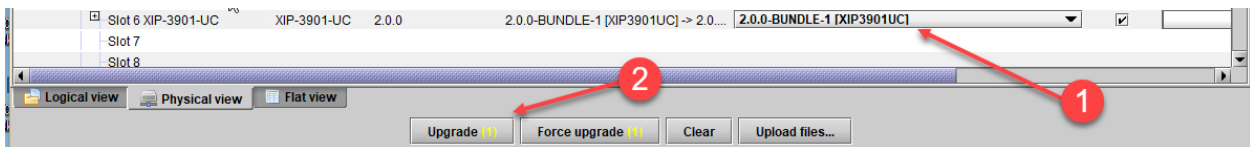

The installation progress bar should update, as shown below:

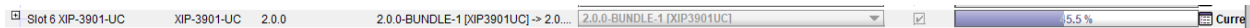

And then it completes.

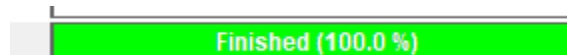

The XIP-3901 card then will disappear for 30 seconds as it will reboot after the upgrade and then it will show the XIP-3901 card with the right firmware and installed package, as show below.

Slot 6 XIP-3901-UC	XIP-3901-UC	2.0.0	2.0.0-BUNDLE-1 [XIP3901UC]
--------------------	-------------	-------	----------------------------

You can use the **Available package** pulldown to activate any other application, at any time. The last installed application will be the current one running on the XIP-3901.

7.4 Opening the XIP-3901 Panel

1. Close the Densité Upgrade Manager and then launch the XIP-3901 application from iControl Solo by double clicking on the XIP-3901-UC application to launch the iControl panel for the card. As shown below, this example shows that the XIP-3901-UC was the last application installed on the card:

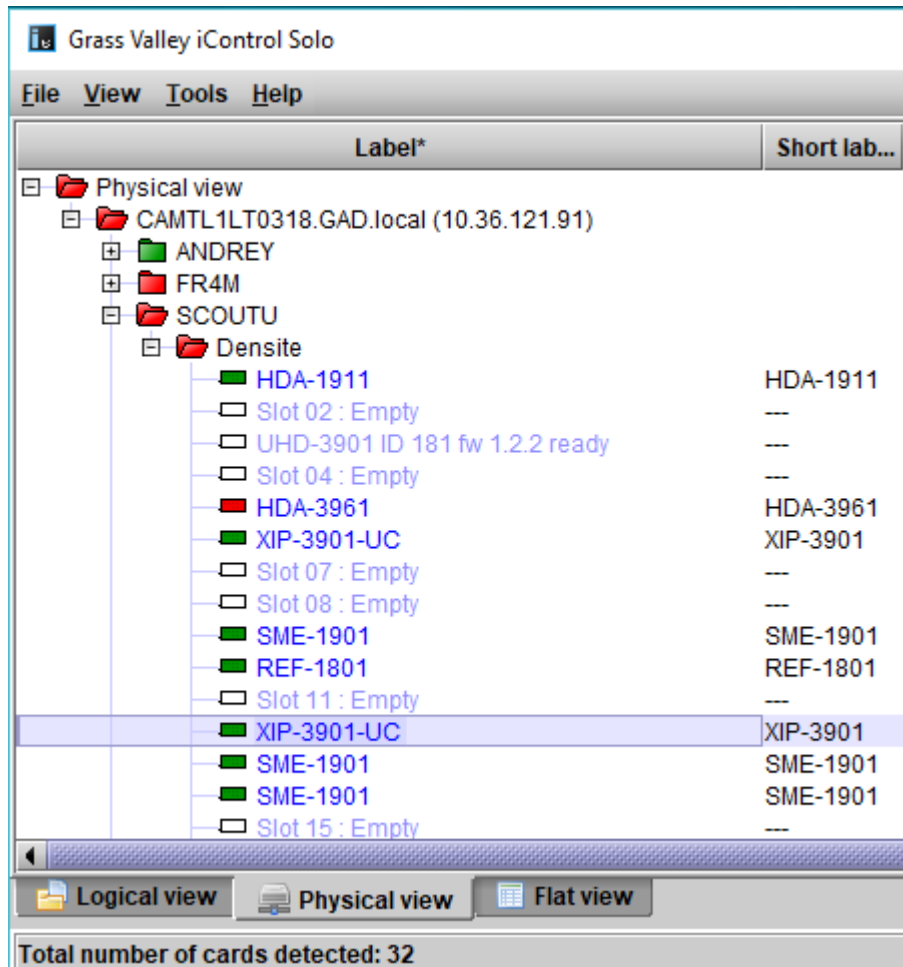

The iControl panel for the card then shown.

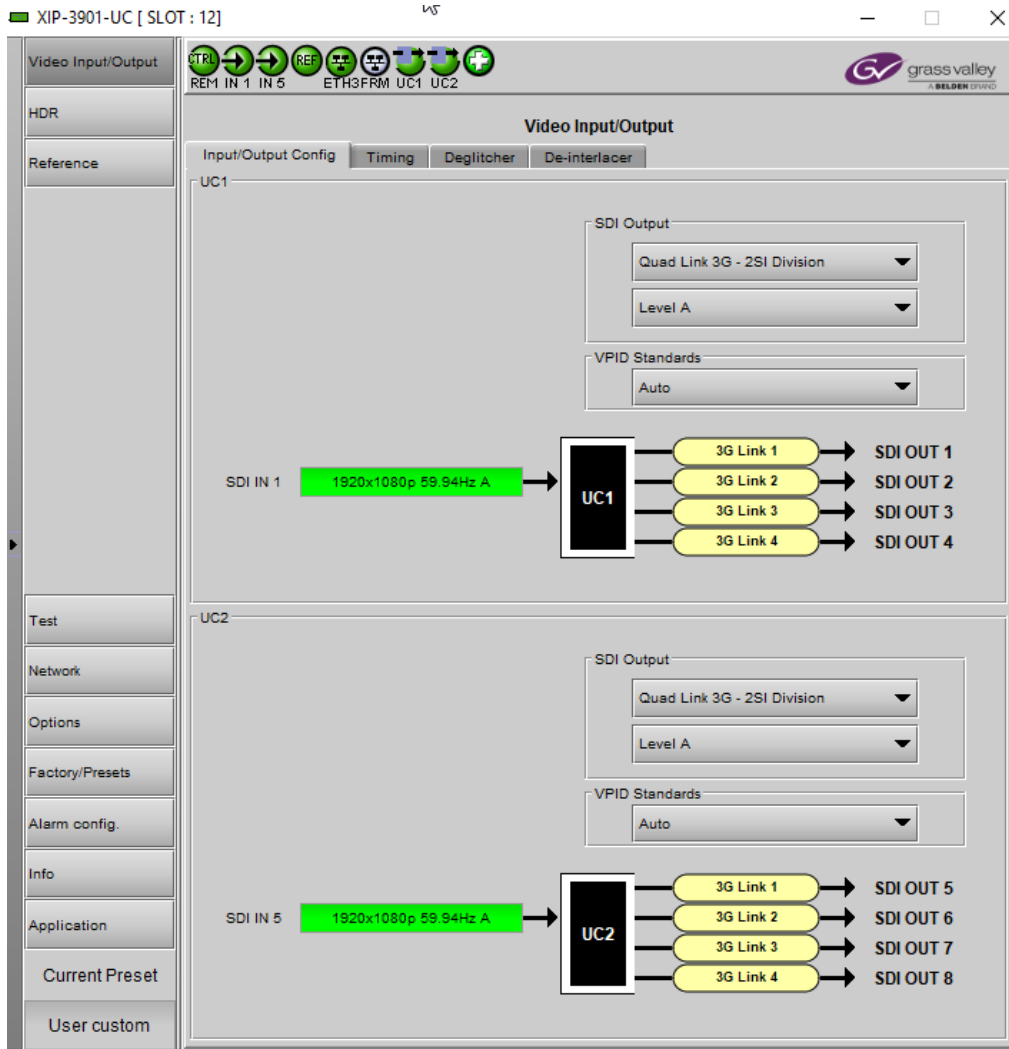

You can also change the current application in the **Application** panel. See 12.4 - Application Panel on page 141.

8 iControl System User Interface

The XIP-3901 applications can be remotely controlled using Grass Valley's iControl system. This manual describes the control panels associated with the XIP-3901 applications and their use. Please consult the iControl User's Guide for information about setting up and operating iControl.

In iControl Navigator or iControl Websites, double-click on the XIP-3901-UC, XIP-3901-DC, XIP-3901-FS, XIP-3901-UDC-IP or XIP-3901-GB-IP icon to open the control panel (for XIP-3901-UC v1.0 only, the icon shows XIP-3901).

The basic window structure is shown in Figure 16. Although the example displayed is from the XIP-3901-UC, the XIP-3901-DC, XIP-3901-FS, XIP-3901-UDC-IP, and XIP-3901-GB-IP interfaces follow the same structure. The window title bar shows the card type and the slot number where the card is installed in its Densité frame.

There are four main sections in the window:

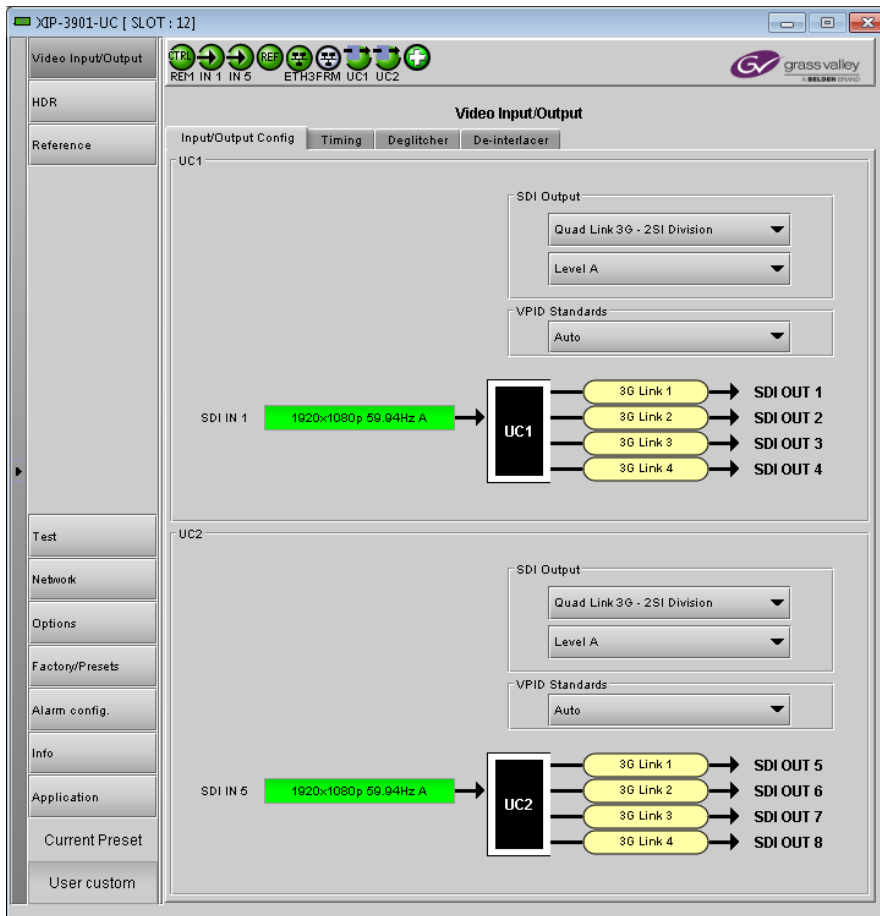

Figure 16– XIP-3901 iControl Graphic Interface (Shown on XIP-3901-UC)

Section 1: The top section displays icons that report different statuses, such as the card communication status, input status, health status, and card operation mode. Mousing over an icon will display a status message with additional information.



Figure 17 –XIP-3901-UC Status Icons



Figure 18 –XIP-3901-DC Status Icons



Figure 19 –XIP-3901-FS Status Icons



Figure 20 – XIP-3901-UDC-IP Status Icons















Figure 21 – XIP-3901-GB-IP Status Icons



















Figure 22– XIP-3901 Status Message (mouse over a status icon, shown on XIP-3901-UC)

The table below describes the various iControl status icons that can appear. If more than one interpretation is possible, read the error message in the iControl window to see which applies.

Manual Card Configuration	
	Remote card control is activated. The iControl interface can be used to operate the card.
	Local card control is activated. The card is being controlled using the Densité frame control panel, as described in 6 Local Control Using the Densité Frame Control Panel. Any changes made using the iControl interface will have no effect on the card.

Media Network (UDC-IP and GB-IP only)	
 IP (green)	No IP status error.
 IP (red)	At least one IP status is in error. See: <ul style="list-style-type: none"> • Receiver Stream statuses: see 10.4.1 - Config Tab on page 85 • Receiver Media statuses: see 10.4.2 - Timing Tab on page 87 • Receiver Media statuses: see 10.4.3 - Redundancy Tab on page 88 • Sender Stream statuses: see 10.7.1 - UDC1/2 Tab on page 101 • NMOS IS-04 Registration status: see 10.3 - NMOS Panel on page 83
UDC1 / UDC2 Input Status (-UDC-IP only)	
 UDC1 (green)	Video is present and valid. The video format is indicated when there are no errors.
 UDC1 (red)	Video not present; or Video invalid; or Video unsupported; or Rate mismatch.
 UDC1 (grey)	Receiver Disabled.
GB1 / GB2 Input Status (-GB-IP only)	
 GB1 (green)	Video is present and valid. The receiver operation mode is indicated.
 GB1 (red)	Video not present; or Video invalid; or Video unsupported.
 GB1 (grey)	Receiver Disabled.
SDI IN Status (UC)	
 (green)	SDI is present and valid. The video format is indicated when there are no errors.
 (red)	SDI not present; or SDI invalid; or SDI unsupported; or Reference mismatch.

SDI IN Status (DC and FS only)	
 (green)	All SDI inputs are present and valid. At least one SDI input is reporting an error. See the diagram in the Input/Output Config tab to diagnose the issue.
 (red)	At least one SDI input is reporting an error. See the diagram in the Input/Output Config tab to diagnose the issue.
Reference Status (UC, DC, and FS only)	
 (green)	Reference on both channels is locked.
 (red)	Reference on at least one channel is not locked. See 9.6 - Reference Panel for more details on the problem(s).
URS Status (UDC-IP only)	
 (green)	Reference on both channels is locked on the Universal Reference Signal from the Densité frame's backplane.
 (red)	Reference on at least one channel is not locked. See 9.6 - Reference Panel for more details on the problem(s).
PTP Status (UDC-IP and GB-IP only)	
 (green)	The card is locked to the network's PTP.
 (red)	The card is not locked to the network's PTP. See 10.2 - PTP Panel for more details on the problem(s).
Network Status (ETH1/ETH2/ETH3/FRM)	
 (green)	Network linkup and active.
 (red)	No network link (port down).
 (gray)	Network port is disabled.
 (yellow)	Network connections in progress.

Operating Mode	
 (green)	Operating mode: Process
 (red)	Operating mode: Color Bars & Tone
Health Monitoring	
 (green)	Hardware OK.
 (red)	Hardware failure detected. If this icon is flashing red, call Technical Support.

If there is an error, the error status message will appear in the message area.

- If there are multiple errors, the error messages cycle so that each message can be seen.
- The icon for the status or error message being shown will be highlighted in mauve.

Section 2: The left portion of the window contains buttons for each individual panel, which are highlighted when they are selected. Section 3 then displays the selected panel.

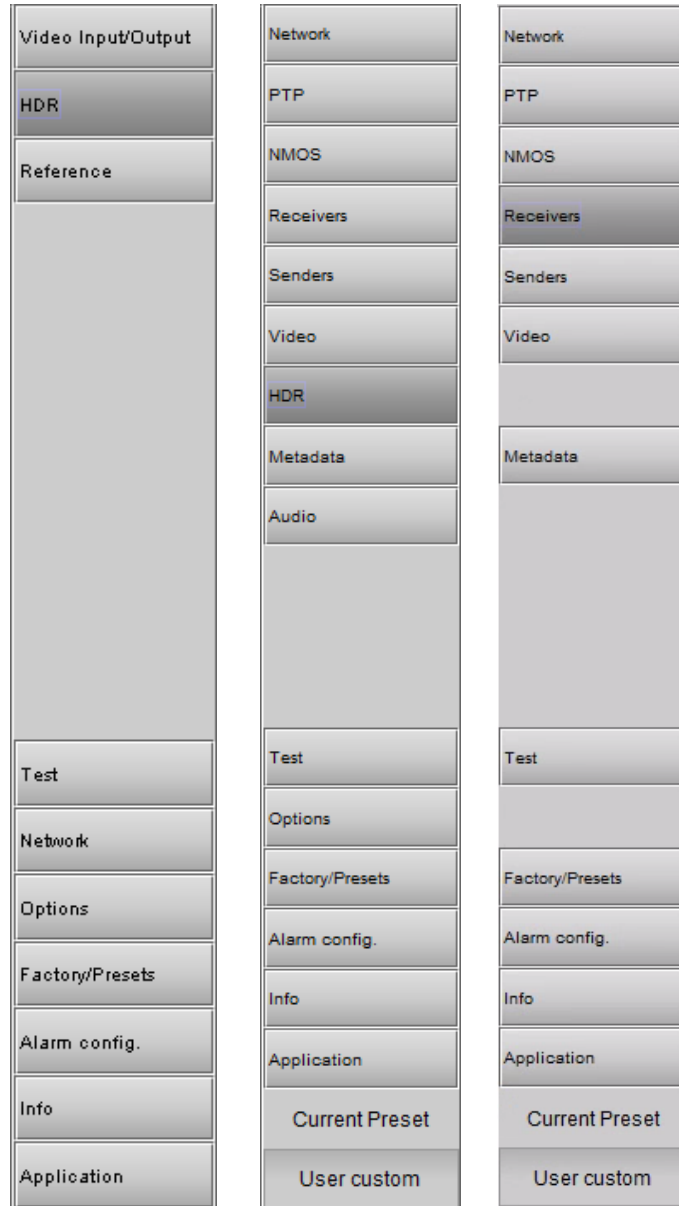

Figure 23– Buttons for Each Individual Panel (XIP-3901-UC, XIP-3901-DC, and XIP-3901-FS on the left, XIP-3901-UDC-IP in the middle, and XIP-3901-GB-IP on the right)

Section 3: This main section displays the panel selected in Section 2. It may contain multiple tabs to access any appropriate sub-panel.

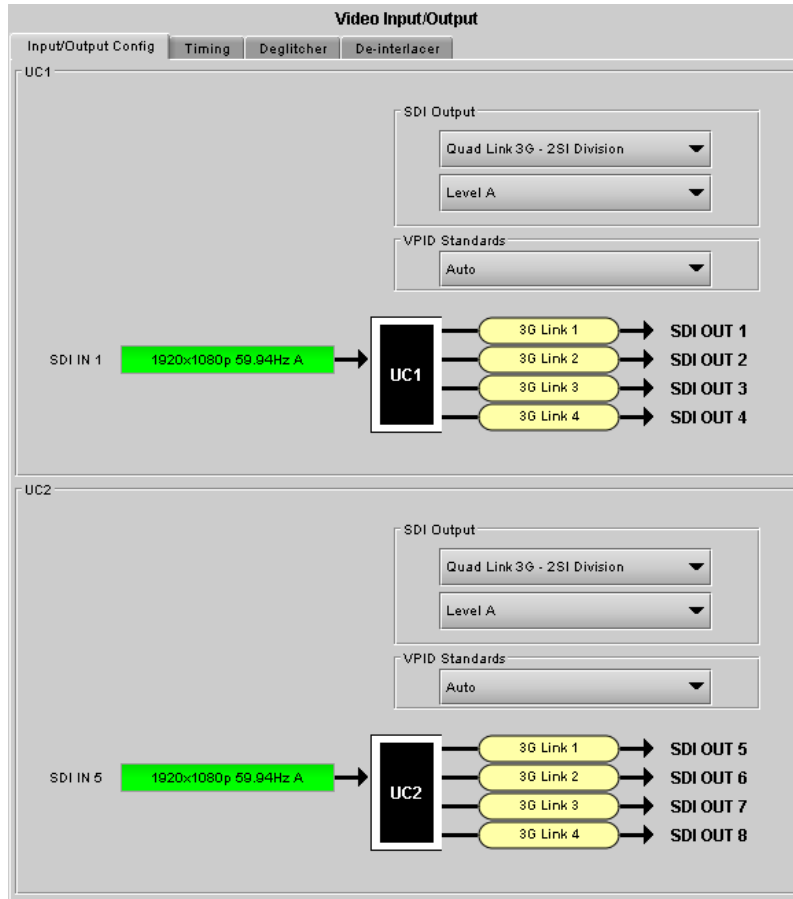

Figure 24– Panel Display (Shown on XIP-3901-UC)

Section 4: The lower left corner of the window identifies the preset currently in use, “User custom” if none is applicable, or “Factory default” when the card is currently using its factory-default settings.

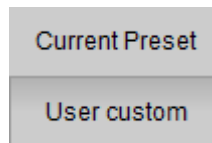

Figure 25–Current Preset or User Custom

8.1 XIP-3901 Card Application Configuration

To Configure	See
XIP-3901-UC, XIP-3901-DC, or XIP-3901-FS	9 - Configuring the XIP-3901-UC / -DC / -FS Applications Using iControl on page 43
XIP-3901-UDC-IP	10 - Configuring the XIP-3901-UDC-IP Application Using iControl on page 76
XIP-3901-GB-IP	11 - Configuring the XIP 3901-GB-IP Application Using iControl on page 120

9 Configuring the XIP-3901-UC / -DC / -FS Applications Using iControl

This section describes the control panels associated with the XIP-3901-UC / -DC / -FS applications and their use.

9.1 Video Input/Output Panel (XIP-3901-UC)

9.1.1 Input/Output Config Tab

This panel allows you to configure the settings for the two upconverters. Each can be configured independently.

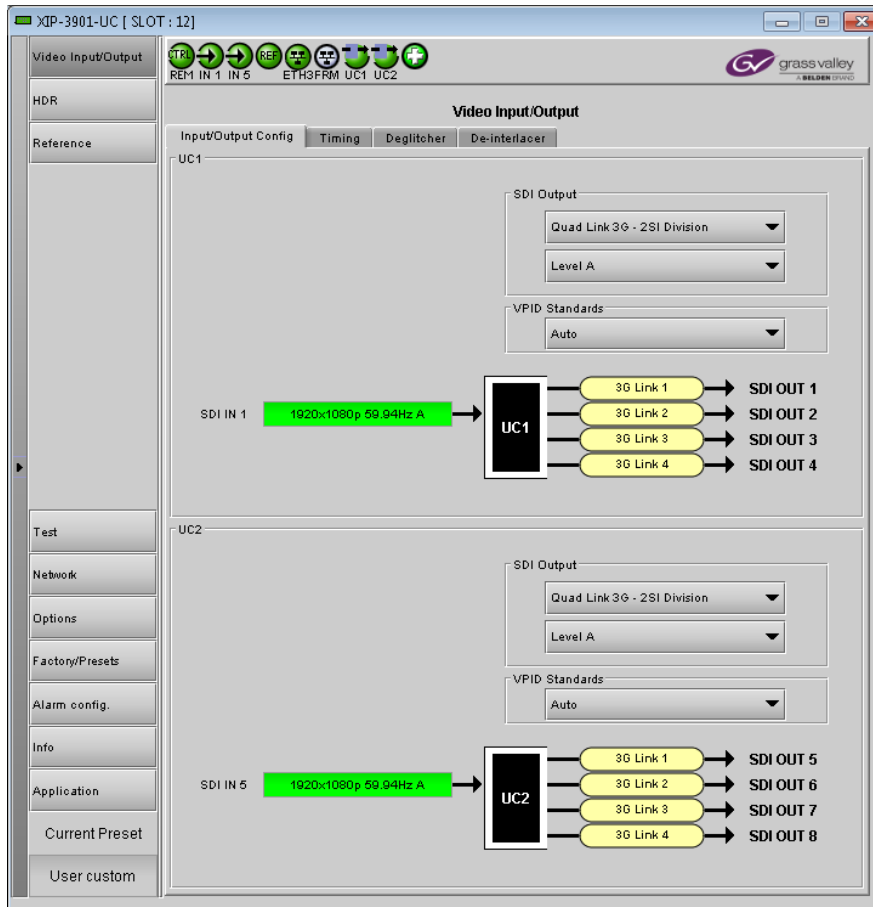

Figure 26–Video I/O Config

Use the pulldown menus to configure these parameters:

Parameter		Settings	Note
SDI Output	Transport & 2160-Line Data Mapping (on Quad Link 3G)	Quad Link 3G – 2SI Division (default) Quad Link 3G – Square Division 12G 3G	1
	3G Mapping	Level A (default) Level B Dual-Link	3
VPID Standards		Auto (default) 3 Gb/s Legacy (SMPTE 425-1)	2

Note 1: For each upconverter, you must select the format of the SDI output transport using the SDI Output pulldown menu. For the Quad Link 3G SDI Transport setting, you must also select which 2160-Line Data Mapping to use (Square Division or 2SI Division). The choice will depend on the format used by the destination equipment.

- Quad Link 3G – Square Division: The 4K image is split into four full-resolution quadrants, each sent on a single 3G link.
- Quad Link 3G – 2SI Division: The 4K image is sub-sampled into four full-frame images, each at half the vertical and horizontal resolution.
- 12G: The 4K image is sent on a single 12G link.
- 3G: The image is sent on a single 3G Link.

Note 2: Usually, 2-Sample Interleave outputs have a different VPID on each link, per SMPTE 425-5. Some downstream equipment may not support this standard, so the use of SMPTE 425-1 VPIDs can be forced by selecting 3Gb/s legacy in the VPID Standards pulldown menu. VPID Standards settings are ignored when the SDI Output is set to 3G or 12G.

VPID Standards	Quad Link 3G	
	Square Division	2SI Division
Auto	SMPTE 425-1	SMPTE 425-5
3Gb/s legacy	SMPTE 425-1	SMPTE 425-1

Note 3: The XIP-3901-UC supports two of the mappings of video into the serial digital interface defined by SMPTE 424M. 3G Mapping settings are ignored when the SDI Output is set to 12G.

- The Level A format is the direct mapping of uncompressed 1080p (up to 60 fps) video into a serial digital interface at the nominal 3 Gb/s.
- The Level B-DL (DualLink) format is the mapping of DualLink HD-SDI/SMPTE 372M (for example, 1080p up to 60 fps) in a single serial digital interface at the nominal 3 Gb/s.

A diagram of the upconversion process is displayed underneath the settings for each upconverter. Each link will be either green (no error) or red (error).

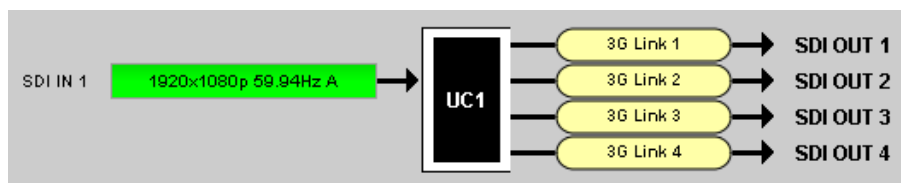

Figure 27– Upconversion Diagram

9.1.2 Timing Tab

For each upconverter, you can adjust the timing relative to the reference. Use the slider or type a value into the data box on the right of the slider.

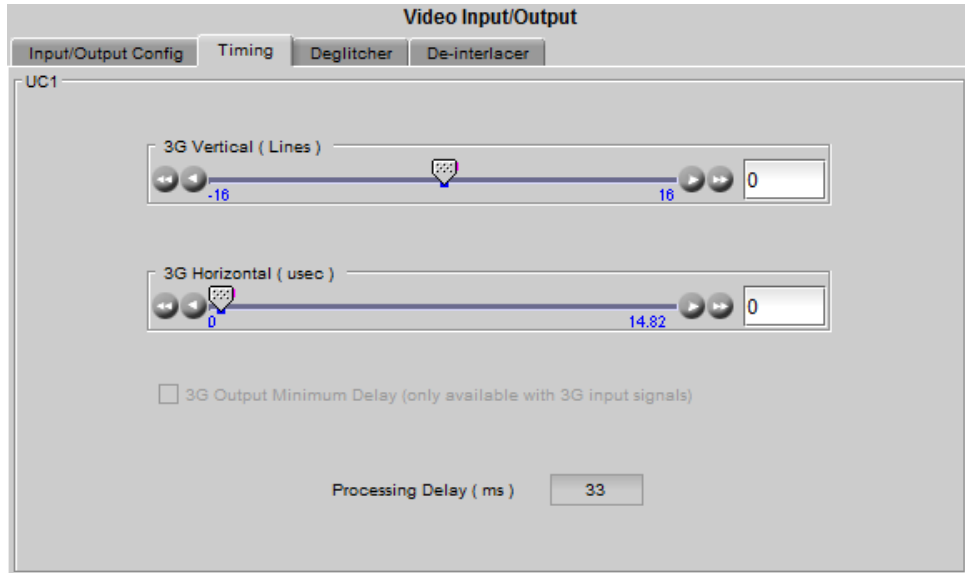

Figure 28–Video I/O Timing

The sliders can be adjusted as follows:

Adjustment	Range
Vertical (lines)	-16 to +16
Horizontal (µsec)	Up to 1 line: 0 to 14.82µsec (59 Hz) 0 to 17.77µsec (50 Hz)

For a 3G SDI Output, the 3G Output Minimum Delay setting can be enabled. In this case, the reference source will be forced to Input for this channel and the user settings for the reference source will be ignored (see 9.6 - Reference Panel on page 69 for more information). The 3G Mapping settings will also be ignored. If Level A format is received, the card will output Level A. If Level B DualLink format is received, the card will output Level B DualLink. The following features are also disabled:

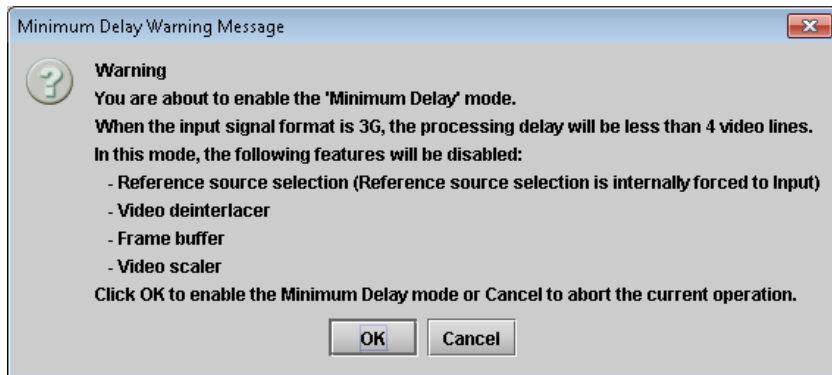

Figure 29–Disabled Features

This section also displays the Processing Delay in milliseconds (ms) for each channel so you can manage the processing delay on your system.

Min. Delay	Ref	SDI Input	SDI Output	Processing Delay			
				Async or Isochrone Inputs		Synced & Phase-Aligned Inputs	
				Minimum	Maximum	59Hz	50Hz
OFF	Input	1080i	ALL	2 fields	2 fields	33 ms	40 ms
		720p, 1080p	ALL	2 frames	2 frames	33 ms	40 ms
	URS, External	1080i	ALL	12 ms + 1 field	12 ms + 3 fields	33 ms	40 ms
		720p, 1080p	ALL	12 ms + 1 frame	12 ms + 2 frames	33 ms	40 ms
ON	Input	1080p	1080p	< 4 lines	< 4 lines	< 4 lines	< 4 lines

The XIP-3901 has an integrated frame sync that supports synchronous and asynchronous SDI input signals. The input signals will be synchronized and realigned to either the URS or External Reference.

The frame sync behaves like a frame buffer. It also supports frame skips/repeats in the case of an asynchronous SDI input. When an input error occurs, it freezes to the last valid field/frame.

Min. Delay	Ref	Signal	SDI Input	SDI Output	Skip/Repeat Period	Freeze on Input Error		
OFF	Input	ALL	ALL	ALL	N/A	None		
	URS, External	Video	HD/1080i	ALL	ALL	2 fields	Last valid field	
			HD/720p	ALL	ALL	1 frame	Last valid frame	
			3G Level A	ALL	ALL	1 frame	Last valid frame	
			3G Level B DL	12G	ALL	ALL	1 frame	Last valid frame
				3G Level A	ALL	ALL	1 frame	Last valid frame
				Quad Link 3G Level A	ALL	ALL	1 frame	Last valid frame
				3G Level B DL	ALL	ALL	2 frames	Last valid frame
			Quad Link 3G Level B DL	ALL	ALL	2 frames	Last valid frame	
	Audio	PCM	ALL	ALL	N/A	Tracking during 15 seconds per frame	Muted	
		Non-PCM	ALL	ALL	N/A	Instant catch-up	Muted	
Metadata	ALL	ALL	ALL	N/A	Lost when skipped, duplicated when repeated	Blanked		
ON	ALL	ALL	ALL	ALL	N/A	None		

9.1.3 Deglitcher Tab

For each upconverter, select the appropriate deglitcher mode (ON or OFF) using the pulldown menu.

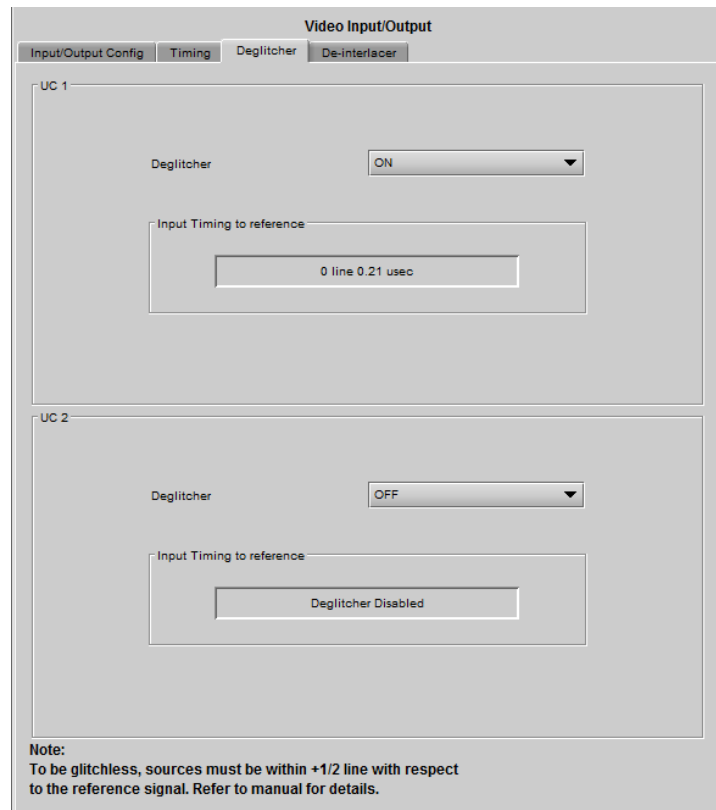

Figure 30– Deglitcher Tab

When the deglitcher is enabled, the card supports a hotswitch between upstream signals without producing a freeze on the frame sync, and without producing artifacts on the output.

The deglitcher must be disabled when the input is asynchronous to the reference. Otherwise, it will create audio and video glitches at the output.

For this mode to function correctly, the following requirements must be met:

- The two inputs must be synchronized to the reference
- They must be phased within one line of each other
- They must be phased to within +/- ½ line of the HREF of the reference signal

The offset from the VREF can be variable, but a distance of greater than 10 lines could create an artifact in the active video. If the two signals are more than one line apart, a vertical jump will occur at the moment of switching that is proportional to the number of vertical lines of offset between the two signals. This will last for only one frame. For more information about using clean switch regions to perform glitch-free switches, see 9.4 - Clean Switch Regions and Examples.

The Input Timing to Reference box reports any difference in timing between the input and reference when the transition occurs. When the deglitcher is disabled, it will display "Deglitcher Disabled". When the deglitcher is enabled, it can display one of the following error messages in red:

- Missing Reference: The External or URS reference source is missing.

- Locked on Input: The reference source is set to Input.
- Video Error: There is an error with the input.

9.1.4 De-interlacer Tab

Each upconverter has its own de-interlacer used during interlaced sources. The Film Mode and Video Over Film settings can either be set to On or Off. By default, both are set to On for optimal performance.

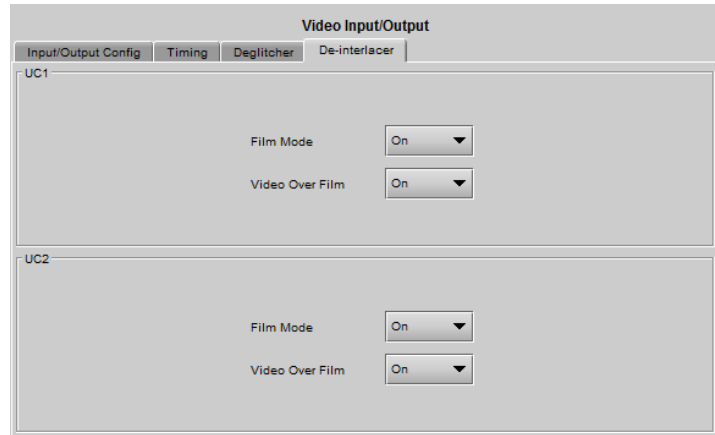

Figure 31–Video I/O De-interlacer

Property	Description
Film Mode	Some interlaced video sources are film-based, originating from 24p film images. When Film Mode is on, the de-interlacer will monitor the input for this type of source. When detected, it will merge the fields to recreate the original 24p image, thereby avoiding de-interlacer artifacts prior to scaling and upconversion. Film detection is provided for 3:2, 2:2 (59 Hz and 50 Hz sources) and 5:5 sequences.
Video Over Film	Video Over Film is available only when Film Mode is enabled. When Video Over Film is on, the de-interlacer will detect video over film content and bypass field-merging on certain video regions such as scrolling video characters over an entire film frame, thereby preventing any unwanted combing effects.

9.2 Video Input/Output Panel (XIP-3901-DC)

9.2.1 Input/Output Config Tab

This panel allows you to configure the settings for the two downconverters. Each can be configured independently.

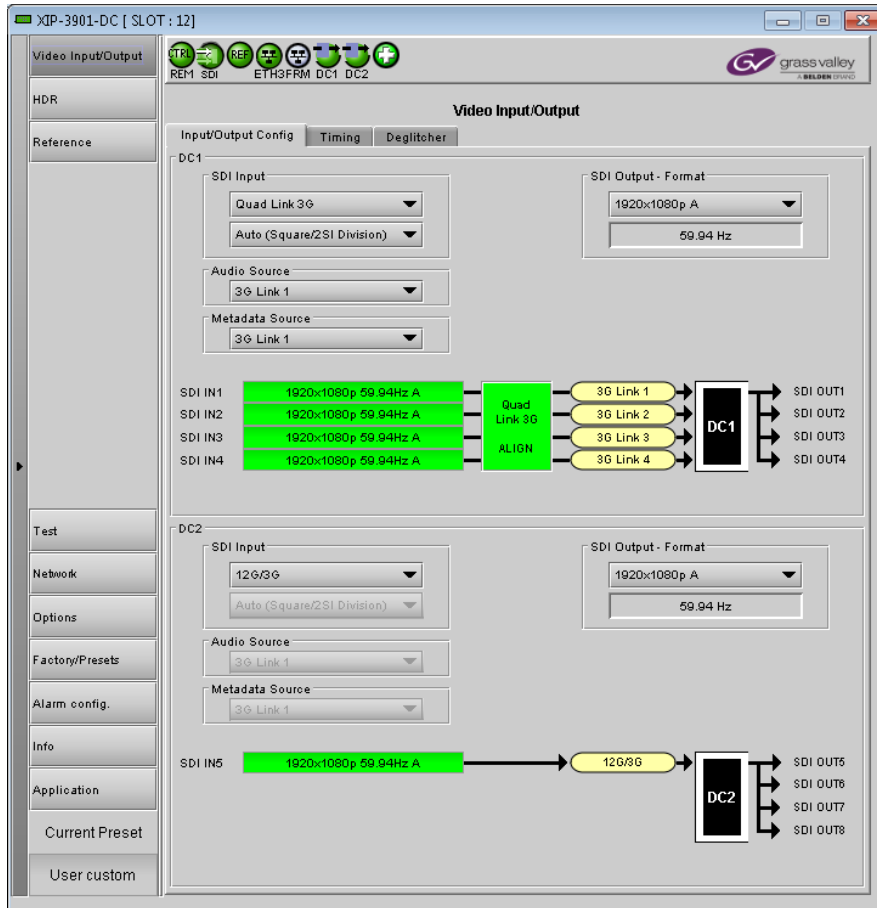

Figure 32– Video I/O Config

Use the pulldown menus to configure these parameters:

Parameter		Settings	Note
SDI Input	SDI Transport	Quad Link 3G (default) 12G/3G	1
	2160-Line Data Mapping	Auto (Square/2SI Division) (default) 2SI Division Square Division	2
Audio Source		3G Link 1 to 4. Set the SDI input link to receive the audio source. Default value is 3G Link 1.	–
Metadata Source		3G Link 1 to 4. Set the SDI input link to receive the metadata source. Default value is 3G Link 1.	–
SDI Output – Format	SDI Output – Resolution	1920x1080p A (default) 1920x1080p B DL 1920x1080i 1280x720p	3

Note 1: For each downconverter, you must select the format of the SDI input transport using the SDI Input pulldown menu. The choice will depend on the format used by the origin equipment.

- Quad Link 3G: The 4K UHD image is split into four full-resolution quadrants, each received on a single 3G link.
- 12G/3G: The 4K UHD image is received on a single 12G or the HD image on a 3G link.

Note 2: For Quad Link 3G SDI Transport, you must also select how 2160-Line Data Mapping is detected.

- Auto (Square/2SI Division): Automatically detects the mapping type based on the incoming VPID on the first link (this setting may not be able to automatically detect certain legacy signals).
- 2SI Division: Assumes 2SI Division regardless of the incoming VPID.
- Square Division: Assumes Square Division regardless of the incoming VPID.

2160-Line Data Mapping settings are ignored when the SDI Input is set to 12G/3G.

Note 3: The frame rate (59.94 Hz or 50 Hz) of the selected SDI output resolution is reported underneath the SDI Output - Resolution menu.

A diagram of the downconversion process is displayed underneath the settings for each downconverter. The status for each input SDI will be either green (no error) or red (error). In the event of an error, you can mouse over this field to display a tooltip with more details.

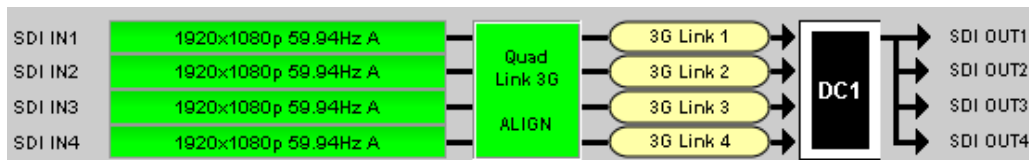

Figure 33–Downconversion Diagram

The possible errors are as follows:

- No Carrier: No SDI Carrier is detected.
- No Error: No errors are detected.
- Video/TRS Error: The received video has TRS errors.

- Not Supported: The received video format is not supported.
- Reference Mismatch: The received video does not match the reference frame rate.
- Wrong Link: Received the wrong Quad Link 3G link on 2SI Division.
- Quad Link 3G Error: The received Quad Link 3G has different video formats.
- Unexpected Format: Did not receive the video format selected by the user.

Quad Link 3G ALIGN monitors the timing of the four link inputs. The timing difference between the Quad Link 3G links shall not exceed 400 ns, as per SMPTE ST-425-5.

Status	Quad Link 3G ALIGN	
Gray	No carrier on Quad Link 3G links	
Green	Timing difference between Quad Link 3G links does not exceed the internal buffer	
Red	Timing difference between Quad Link 3G links exceeds the internal buffer	

9.2.2 Timing Tab

For each downconverter and output resolution, you can adjust the timing relative to the reference. The vertical setting applies to all output formats, whereas the horizontal settings are specific to individual output formats. To adjust the timing, use the slider or type a value into the data box on the right of the slider.

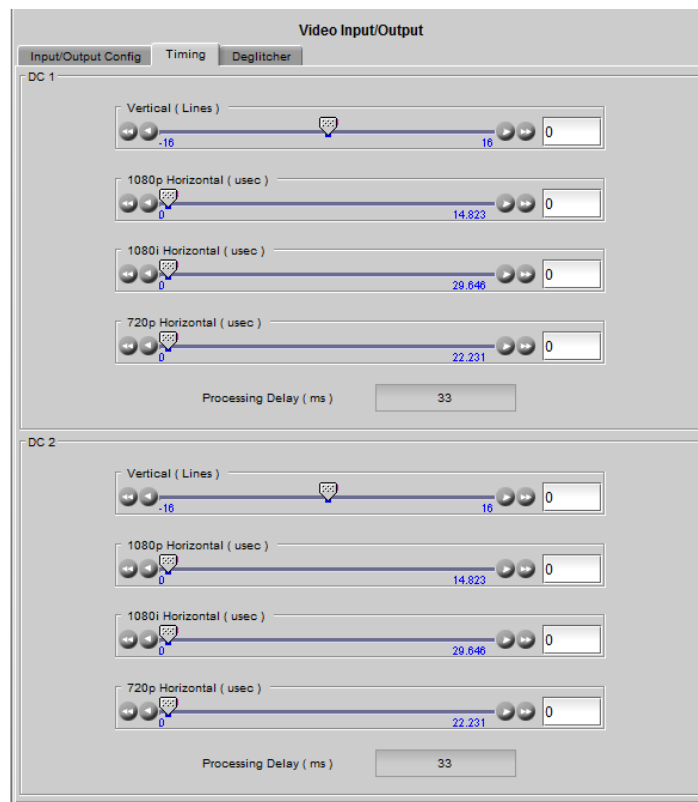

Figure 34– Video I/O Timing

The sliders can be adjusted as follows:

Adjustment	Range (50 Hz)	Range (59 Hz)
Vertical (Lines)	-16 to +16	-16 to +16
1920x1080p (A and B DL) Horizontal (µsec)	0 to 17.771 µsec	0 to 14.825 µsec
1920x1080i Horizontal (µsec)	0 to 35.542 µsec	0 to 29.646 µsec
1280x720p Horizontal (µsec)	0 to 26.653 µsec	0 to 22.231 µsec

This section also displays the Processing Delay in milliseconds (ms) for each channel so you can manage the processing delay on your system. For more details about processing delay, see the table below.

Ref	SDI Input	SDI Output	Processing Delay			
			Async or Isochrone Inputs		Synced & Phase-Aligned Inputs	
			Min	Max	59Hz	50Hz
Input	ALL	ALL	2 frames	2 frames	33 ms	40 ms
URS, External	3G Level A	ALL	12 ms	12 ms + 1 frame	17 ms	20 ms
	3G Level B DL	HD	12 ms	12 ms + 1 frame	17 ms	20 ms
		3G Level A	12 ms	12 ms + 1 frame	17 ms	20 ms
	3G Level B DL	3G Level B DL	12 ms	12 ms + 2 frames	33 ms	40 ms
	12G	ALL	12 ms + 1 frame	12 ms + 2 frames	33 ms	40 ms
	Quad Link 3G Level A	ALL	12 ms + 1 frame	12 ms + 2 frames	33 ms	40 ms
	Quad Link 3G Level B DL	HD	12 ms + 1 frame	12 ms + 2 frames	33 ms	40 ms
		3G Level A	12 ms + 1 frame	12 ms + 2 frames	33 ms	40 ms
3G Level B DL		12 ms + 2 frames	12 ms + 4 frames	67 ms	80 ms	

The XIP-3901 has an integrated frame sync that supports synchronous and asynchronous SDI input signals. The input signals will be synchronized and realigned to either the URS or External Reference.

The frame sync behaves like a frame buffer. It also supports frame skips/repeats in the case of an asynchronous SDI input. When an input error occurs, it freezes to the last valid field/frame.

Ref	Signal	SDI Input	SDI Output	Skip/Repeat Period	Freeze on Input Error
Input	ALL	ALL	ALL	N/A	None
URS, External	Video	12G,	ALL	1 frame	Last valid frame
		3G Level A	ALL	1 frame	Last valid frame
		Quad Link 3G Level A	ALL	1 frame	Last valid frame
		3G Level B DL	3G Level A	1 frame	Last valid frame
			3G Level B DL	2 frames	Last valid frame
		Quad Link 3G Level B DL	3G Level A	1 frame	Last valid frame
			3G Level B DL	2 frames	Last valid frame
	Audio	PCM	N/A	Tracking during 15 seconds per frame	Muted
		Non-PCM	N/A	Instant catch-up	Muted
	Metadata	ALL	N/A	Lost when skipped, duplicated when repeated	Blanked

9.2.3 Deglitcher Tab

For each downconverter, select the appropriate deglitcher mode (ON or OFF) using the pulldown menu.

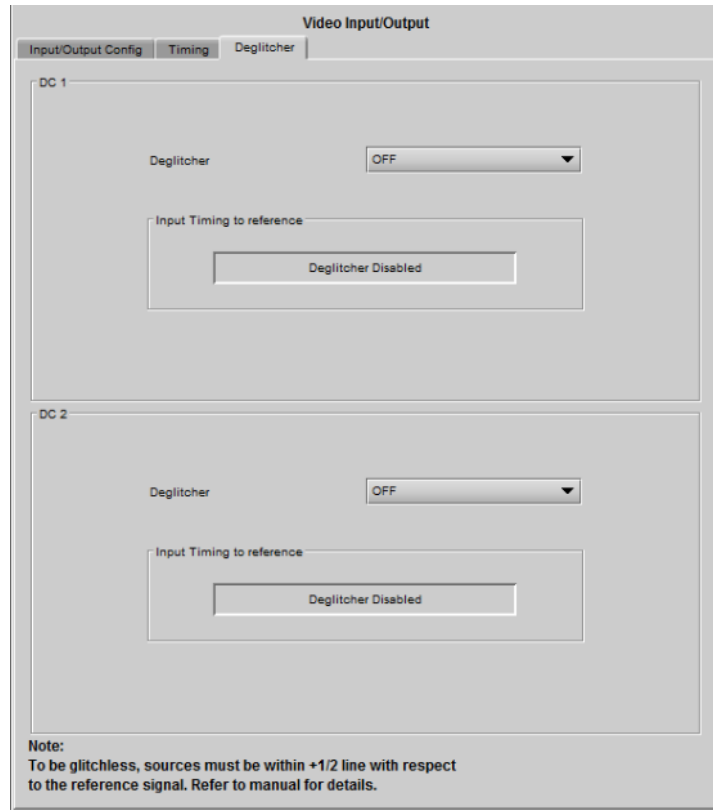

Figure 35– Deglitcher Tab

When the deglitcher is enabled, the card supports a hot switch between upstream signals without producing a freeze on the frame sync, and without producing artifacts on the output.

The deglitcher must be disabled when the input is asynchronous to the reference. Otherwise, it will create audio and video glitches at the output.

For this mode to function correctly, the following requirements must be met:

- The two inputs must be synchronized to the reference
- They must be phased within one line of each other
- They must be phased to within +/- 1/2 line of the HREF of the reference signal

The offset from the VREF can be variable, but a distance of greater than 10 lines could create an artifact in the active video. If the two signals are more than one line apart, a vertical jump will occur at the moment of switching that is proportional to the number of vertical lines of offset between the two signals. This will last for only one frame. For more information about using clean switch regions to perform glitch-free switches, see 9.4 - Clean Switch Regions and Examples.

The Input Timing to Reference box reports any difference in timing between the input and reference when the transition occurs. Since the XIP-3901-DC supports multiple links, the measurement displayed is taken from the first link (shown as SDI IN 1 in the Input/Output Config tab). When the deglitcher is disabled, it will display “Deglitcher Disabled”. When the deglitcher is enabled, it can display one of the following messages in red:

- Missing Reference: The External or URS reference source is missing.
- Locked on Input: The reference source is set to Input.
- Video Error: There is an error with the input.

9.3 Video Input/Output Panel (XIP-3901-FS)

9.3.1 Input/Output Config Tab

This panel allows you to configure the settings for the two synchronizers. Each can be configured independently.

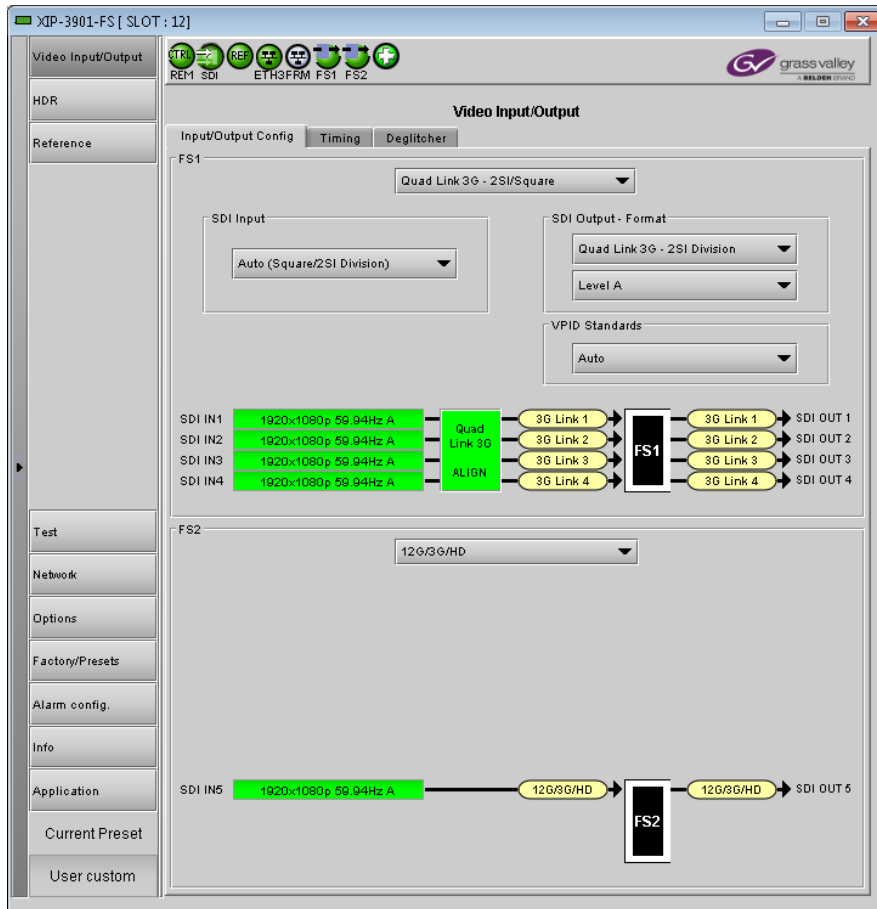

Figure 36– Video I/O Config

Use the topmost pulldown menu to select an operation mode. Depending on the selected mode, you may also need to select an SDI input format, SDI output format, and/or VPID standards.

Operation Mode	Setting Type	Settings	Note
12G/3G/HD	N/A	N/A	N/A
Quad Link 3G (default)	N/A	N/A	N/A
3G Level A/B DL	SDI Output – Format (3G Mapping)	Level A (default) Level B Dual-Link	3
Quad Link 3G - 2SI/Square	SDI Input (2160p Data Mapping)	Auto (Square/2SI Division) (default) 2SI Division Square Division	1
	SDI Output - Format (2160p Data Mapping)	Quad Link 3G - Square Division Quad Link 3G - 2SI Division (default)	2
	SDI Output - Format (3G Mapping)	Level A (default) Level B Dual-Link	3
	VPID Standards *only active for 2SI Division	Auto (default) 3Gb/s legacy (SMPTE 425-1)	4
Quad Link 3G to 12G	SDI Input (2160p Data Mapping)	Auto (Square/2SI Division) (default) 2SI Division Square Division	1
12G to Quad Link 3G	SDI Output - Format (2160p Data Mapping)	Quad Link 3G - Square Division Quad Link 3G - 2SI Division (default)	2
	SDI Output - Format (3G Mapping)	Level A (default) Level B Dual-Link	3
	VPID Standards *only active for 2SI Division	Auto (default) 3Gb/s legacy (SMPTE 425-1)	4

Note 1: Using the Auto setting, the XIP-3901-FS can automatically detect whether the input format is Square Division or 2SI Division. You can also choose to consider the input as either Square Division or 2SI Division.

Note 2: For the Quad Link 3G SDI Output - Format setting, you must select which 2160p Data Mapping to use (Square Division or 2SI Division). The choice will depend on the format used by the destination equipment.

- Quad Link 3G – Square Division: The 4K image is split into four full-resolution quadrants, each sent on a single 3G link.
- Quad Link 3G – 2SI Division: The 4K image is sub-sampled into four full-frame images, each at half the vertical and horizontal resolution.

Note 3: The XIP-3901-FS supports two of the mappings of video into the serial digital interface defined by SMPTE 424M. 3G Mapping settings are ignored when the SDI Output is set to 12G.

- The Level A format is the direct mapping of uncompressed 1080p (up to 60 fps) video into a serial digital interface at the nominal 3 Gb/s.
- The Level B DL (Dual-Link) format is the mapping of Dual-Link HD-SDI/SMPTE 372M (for example, 1080p up to 60 fps) in a single serial digital interface at the nominal 3 Gb/s.

Note 4: Usually, 2-Sample Interleave outputs have a different VPID on each link, per SMPTE 425-5. Some downstream equipment may not support this standard, so the use of SMPTE 425-1 VPIDs can be forced by selecting 3Gb/s legacy in the VPID Standards pulldown menu. VPID Standards settings are ignored when the SDI Output is set to 3G or 12G.

VPID Standards	Quad Link 3G	
	Square Division	2SI Division
Auto	SMPTE 425-1	SMPTE 425-5
3 Gb/s legacy	SMPTE 425-1	SMPTE 425-1

A diagram of the synchronization process is displayed underneath the settings for each synchronizer. The status for each input SDI will be either green (no error) or red (error). In the event of an error, you can mouse over this field to display a tooltip with more details.

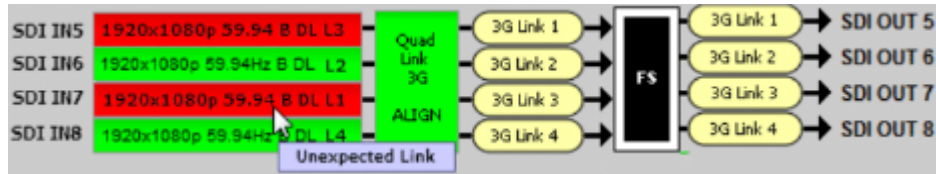

Figure 37–Synchronization Diagram

The possible errors are as follows:

- No Carrier: No SDI Carrier is detected.
- No Error: No errors are detected.
- Video/TRS Error: The received video has TRS errors.
- Not Supported: The received video format is not supported.
- Reference Mismatch: The received video does not match the reference frame rate.
- Wrong Link: Received the wrong Quad Link 3G link on 2SI Division.
- Quad Link 3G Error: The received Quad Link 3G has different video formats.
- Unexpected Format: Did not receive the video format selected by the user.

Quad Link 3G ALIGN monitors the timing of the four link inputs. The timing difference between the Quad Link 3G links shall not exceed 400 ns, as per SMPTE ST-425-5.

Status	Quad Link 3G ALIGN
Gray	No carrier on Quad Link 3G links
Green	Timing difference between Quad Link 3G links does not exceed the internal buffer
Red	Timing difference between Quad Link 3G links exceeds the internal buffer

9.3.2 Timing Tab

For each synchronizer and output resolution, you can adjust the timing relative to the reference. The vertical setting applies to all output formats, whereas the horizontal settings are specific to individual output formats. To adjust the timing, use the slider or type a value into the data box on the right of the slider.

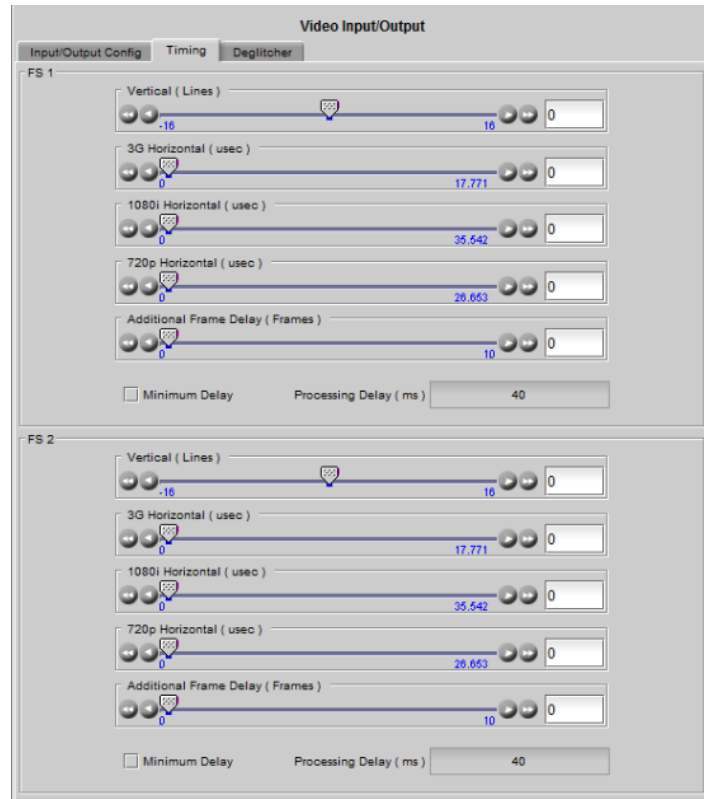

Figure 38– Video I/O Timing

The sliders can be adjusted as follows:

Adjustment	Range (50 Hz)	Range (59 Hz)
Vertical (Lines)	-16 to +16	-16 to +16
1920x1080p (A and B DL) Horizontal (μsec)	0 to 17.771 μsec	0 to 14.825 μsec
1920x1080i Horizontal (μsec)	0 to 35.542 μsec	0 to 29.646 μsec
1280x720p Horizontal (μsec)	0 to 26.653 μsec	0 to 22.231 μsec
Additional Frame Delay	0 to 10	0 to 10

Additional frame delay is usually selected in steps of one frame, but some exceptions exist for 1080p B DL where you can only select frames in multiples of two. The following table lists the number of frame steps for each combination of operation modes and SDI inputs and outputs.

Operation Mode	SDI Input	SDI Output	Frame Steps
12G/3G/HD	1080p A, 1080i, 720p, 2160p	N/A	1
	1080p B DL	N/A	2
Quad Link 3G	Quad Link 3G Level A	N/A	1
	Quad Link 3G Level B DL	N/A	2
3G Level A/B DL	1080p A	1080p A	1
		1080p B DL	1
	1080p B DL	1080p A	1
		1080p B DL	2
Quad Link 3G - 2SI/Square	Quad Link 3G Level A	1080p A	1
		1080p B DL	1
	Quad Link 3G Level B DL	1080p A	1
		1080p B DL	2
Quad Link 3G to 12G	Quad Link 3G Level A, Quad Link 3G Level B DL	2160p	1
12G to Quad Link 3G	2160p	1080p A	1
		1080p B DL	1

This section also displays the Processing Delay in milliseconds (ms) for each channel so you can manage the processing delay on your system. For more details about processing delay, see the tables below for the various operation modes.

12G/3G/HD and Quad Link 3G

Min. Delay	Ref	Operation Mode	SDI Input (SDI output = SDI input)	Processing Delay				
				Async or Isochrone Inputs		Synced & Phase-Aligned Inputs		
				Min.	Max.	59 Hz	50Hz	
OFF	Input	ALL	ALL	2 frames	2 frames	33 ms	40 ms	
			12G/3G/HD	12G, 3G Level A	3 ms	3 ms + 1 frame	17 ms	20 ms
				HD	3 ms	3 ms + 2fields	33 ms	40 ms
	3G Level B DL	3 ms		3 ms + 2 frames	33 ms	40 ms		
	Quad Link 3G	Quad Link 3G Level A	3 ms	3 ms + 1 frame	17 ms	20 ms		
		Quad Link 3G Level B DL	3 ms	3 ms + 2 frames	33 ms	40 ms		
ON		Input	ALL	HD	< 3 lines	< 3 lines	< 3 lines	< 4 lines
3G Level A	< 3 lines			< 3 lines	< 3 lines	< 3 lines		
3G Level B DL	< 6 lines			< 6 lines	< 6 lines	< 6 lines		
12G	< 4 lines			< 4 lines	< 4 lines	< 4 lines		
2SI Quad Link 3G Level A	< 4 lines			< 4 lines	< 4 lines	< 4 lines		
2SI Quad Link 3G Level B DL	< 7 lines			< 7 lines	< 7 lines	< 7 lines		
SQ Quad Link 3G Level A	< 3 lines			< 3 lines	< 3 lines	< 3 lines		
SQ Quad Link 3G Level B DL	< 6 lines			< 6 lines	< 6 lines	< 6 lines		

3G Level A/B DL

Ref	SDI Input	SDI Output	Processing Delay			
			Async or Isochrone Inputs		Synced & Phase-Aligned Inputs	
			Min.	Max.	59 Hz	50Hz
Input	ALL	ALL	2 frames	2 frames	33 ms	40 ms
URS, External	3G Level A	ALL	3 ms	3 ms + 1 frame	17 ms	20 ms
	3G Level B DL	3G Level A	3 ms	3 ms + 1 frame	17 ms	20 ms
		3G Level B DL	3 ms	3 ms + 2 frames	33 ms	40 ms

Quad Link 3G – 2SI/Square

Ref	SDI Input	SDI Output	Processing Delay			
			Async or Isochrone Inputs		Synced & Phase-Aligned Inputs	
			Min.	Max.	59Hz	50Hz
Input	ALL	ALL	2 frames	2 frames	33 ms	40 ms
URS, External	2SI Quad Link 3G Level A	2SI Quad Link 3G Level A	3 ms	3 ms +1 frame	17 ms	20 ms
		2SI Quad Link 3G Level B DL	3 ms	3 ms +1 frame	17 ms	20 ms
	2SI Quad Link 3G Level B	2SI Quad Link 3G Level A	3 ms	3 ms +1 frame	17 ms	20 ms
		2SI Quad Link 3G Level B DL	3 ms	3 ms + 2 frames	33 ms	40 ms
	2SI Quad Link 3G Level A	SQ Quad Link 3G Level A	3 ms +1 frame	3 ms + 2 frames	33 ms	40 ms
		SQ Quad Link 3G Level B DL	3 ms +1 frame	3 ms + 2 frames	33 ms	40 ms
	2SI Quad Link 3G Level B	SQ Quad Link 3G Level A	3 ms +1 frame	3 ms + 2 frames	33 ms	40 ms
		SQ Quad Link 3G Level B DL	3 ms + 2 frames	3 ms + 4 frames	67 ms	80 ms
	SQ Quad Link 3G Level A	2SI Quad Link 3G Level A	3 ms +1 frame	3 ms + 2 frames	33 ms	40 ms
		2SI Quad Link 3G Level B DL	3 ms +1 frame	3 ms + 2 frames	33 ms	40 ms
	SQ Quad Link 3G Level B	2SI Quad Link 3G Level A	3 ms +1 frame	3 ms + 2 frames	33 ms	40 ms
		2SI Quad Link 3G Level B DL	3 ms + 2 frames	3 ms + 4 frames	67 ms	80 ms
	SQ Quad Link 3G Level A	SQ Quad Link 3G Level A	3 ms	3 ms + 1 frame	17 ms	20 ms
		SQ Quad Link 3G Level B DL	3 ms	3 ms + 1 frame	17 ms	20 ms
	SQ Quad Link 3G Level B	SQ Quad Link 3G Level A	3 ms	3 ms + 1 frame	17 ms	20 ms
		SQ Quad Link 3G Level B DL	3 ms	3 ms + 2 frames	33 ms	40 ms

Quad Link 3G to 12G

Ref	SDI Input	SDI Output	Processing Delay			
			Async or Isochrone Inputs		Synced & Phase-Aligned Inputs	
			Min.	Max.	59Hz	50Hz
Input	ALL	12G	2 frames	2 frames	33 ms	40 ms
URS, External	2SI Quad Link 3G Level A	12G	3 ms	3 ms + 1 frame	17 ms	20 ms
	2SI Quad Link 3G Level B DL	12G	3 ms	3 ms + 1 frame	17 ms	20 ms
	SQ Quad Link 3G Level A	12G	3 ms + 1 frame	3 ms + 2 frames	33 ms	40 ms
	SQ Quad Link 3G Level B DL	12G	3 ms + 1 frame	3 ms + 2 frames	33 ms	40 ms

12G to Quad Link 3G

Ref	SDI Input	SDI Output	Processing Delay			
			Async or Isochrone Inputs		Synced & Phase-Aligned Inputs	
			Min.	Max.	59Hz	50Hz
Input	12G	ALL	2 frames	2 frames	33 ms	40 ms
URS, External	12G	2SI Quad Link 3G Level A	3 ms	3 ms + 1 frame	17 ms	20 ms
	12G	2SI Quad Link 3G Level B DL	3 ms	3 ms + 1 frame	17 ms	20 ms
	12G	SQ Quad Link 3G Level A	3 ms + 1 frame	3 ms + 2 frames	33 ms	40 ms
	12G	SQ Quad Link 3G Level B DL	3 ms + 1 frame	3 ms + 2 frames	33 ms	40 ms

The XIP-3901 has an integrated frame sync that supports synchronous and asynchronous SDI input signals. The input signals will be synchronized and realigned to either the URS or External Reference.

The frame sync behaves like a frame buffer. It also supports frame skips/repeats in the case of an asynchronous SDI input. When an input error occurs, it freezes to the last valid field/frame.

Min. Delay	Ref	Signal	SDI Input	SDI Output	Skip/Repeat Period	Freeze on Input Error
OFF	Input	ALL	ALL	ALL	N/A	None
	URS, External	Video	HD/1080i	HD/1080i	2 fields	Last valid field
			HD/720p	HD/720p	1 frame	Last valid frame
			3G Level A	ALL	1 frame	Last valid frame
			12G	ALL	1 frame	Last valid frame
			3G Level B DL	3G Level A	1 frame	Last valid frame
				3G Level B DL	2 frames	Last valid frame
			Quad Link 3G Level A	ALL	1 frame	Last valid frame
			Quad Link 3G Level B DL	Quad Link 3G Level A	1 frame	Last valid frame
	Quad Link 3G Level B DL	2 frames		Last valid frame		
	Audio	PCM	N/A	Tracking during 15 seconds per frame	Muted	
		Non-PCM	N/A	Instant catch-up	Muted	
Metadata	ALL	N/A	Lost when skipped, duplicated when repeated	Blanked		
ON	ALL	ALL	ALL	ALL	N/A	None

For the 12G/3G/HD and Quad Link 3G operating modes, Minimum Delay can be enabled on a channel. The reference source will be internally forced to Input for the channel, and the user settings for the reference source will be ignored (see 9.6 - Reference Panel on page 69 for more information). The Frame Sync and Deglitcher will be bypassed, and the Test Tone Generator will no longer be available. The following warning message will appear to request confirmation to enable Minimum Delay:

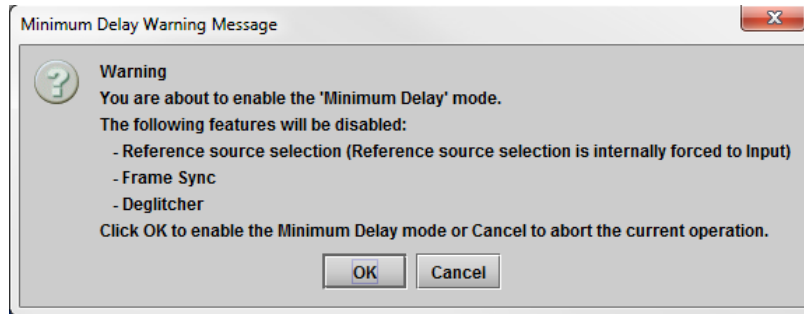

Figure 39– Disabled Features

9.3.3 Deglitcher Tab

For each synchronizer, select the appropriate deglitcher mode (ON or OFF) using the pulldown menu.

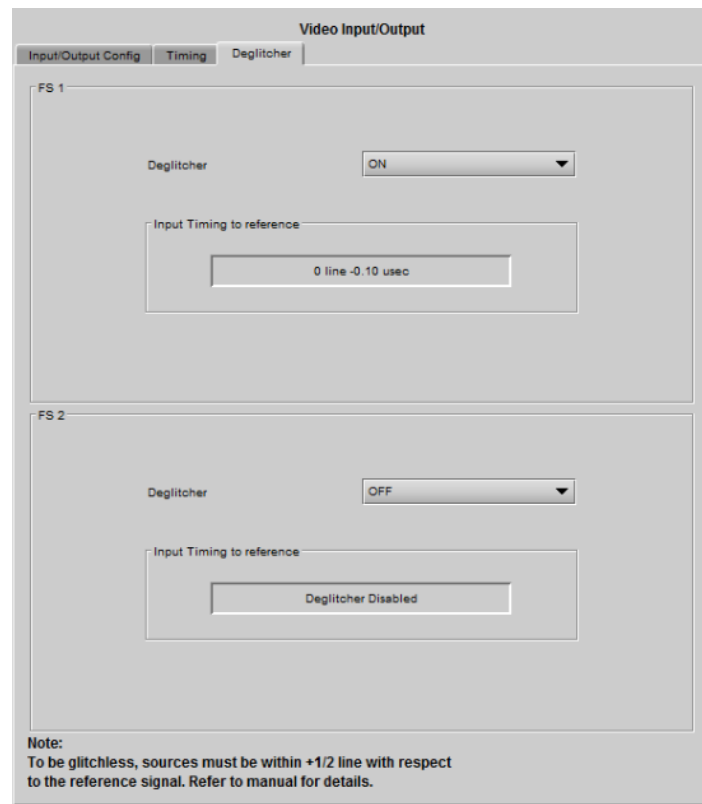

Figure 40– Deglitcher Tab

When the deglitcher is enabled, the card supports a hot switch between upstream signals without producing a freeze on the frame sync, and without producing artifacts on the output.

The deglitcher must be disabled when the input is asynchronous to the reference. Otherwise, it will create audio and video glitches at the output.

For this mode to function correctly, the following requirements must be met:

- The two inputs must be synchronized to the reference
- They must be phased within one line of each other
- They must be phased to within +/- ½ line of the HREF of the reference signal

The offset from the VREF can be variable, but a distance of greater than 10 lines could create an artifact in the active video. If the two signals are more than one line apart, a vertical jump will occur at the moment of switching that is proportional to the number of vertical lines of offset between the two signals. This will last for only one frame. For more information about using clean switch regions to perform glitch-free switches, see 9.4 Clean Switch Regions and Examples.

The Input Timing to Reference box reports any difference in timing between the input and reference when the transition occurs. When the deglitcher is disabled, it will display “Deglitcher Disabled”. When the deglitcher is enabled, it can display one of the following error messages in red:

- Missing Reference: The External or URS reference source is missing.
- Locked on Input: The reference source is set to Input.
- Video Error: There is an error with the input.

9.4 Clean Switch Regions and Examples

To perform a glitch-free switch between two sources, they must be in the same clean switch region. A clean switch region is contained within $\pm \frac{1}{2}$ line about an H=0 point in the reference signal, as shown by the dotted lines in the figure. There is a clean switch region centered on every H interval. As you can see, vertical alignment with the reference is not important for the deglitcher to operate properly.

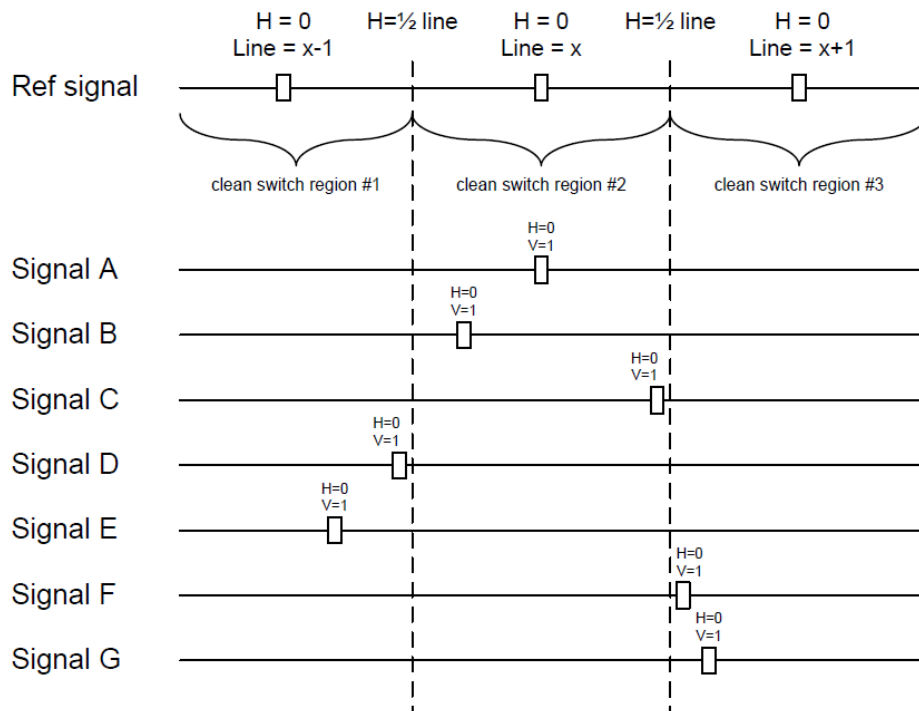

Figure 41 – Clean Switch Regions

You may switch between signals A, B or C, without any glitches, and also between the D->E and F->G signals. Any other transition, like A->D, will cause a vertical image shift for one frame.

To determine whether a clean hot switch is possible, you need to determine whether the two sources lie in the same clean switch region. You can measure the position of the signals with respect to the reference:

- Use the deglitcher tab in iControl (Video Input/Output -> Deglitcher)

When the deglitcher is enabled, the alignment offset between the reference signal and the input signal can be displayed for either of these sources. Knowing the offset for both input signals, you can determine if they are in the same clean switch region. If so, any hot switch between those two signals will be glitch-free.

To determine the limits of a clean switch region, you must know the input's line length in μs . The first region is delimited by $+\frac{1}{2}$ line and $-\frac{1}{2}$ line of the reference. For example, with an HD (1080i59) signal, the line length is $29.65 \mu\text{s}$ and so the first region lies between $-14.83 \mu\text{s}$ and $14.83 \mu\text{s}$. Other regions can be found by adding or removing a multiple of line length to the two boundaries.

Example: For an HD (1080i59) input signal, we have these clean switch regions:

- -1 line and $-14.83 \mu\text{s}$ to 0 line and $-14.83 \mu\text{s}$;
- 0 line and $-14.83 \mu\text{s}$ to 0 line and $14.83 \mu\text{s}$;
- 0 line and $14.83 \mu\text{s}$ to 1 line and $14.83 \mu\text{s}$; etc.

Practical examples:

Example 1: We have two HD (1080i59) sources, one that indicates an offset of $-10 \mu\text{s}$ with respect to the reference (A) and the other an offset of $-20 \mu\text{s}$ (B). We know that a clean switch region limit is present at $-\frac{1}{2}$ line, which corresponds to $-14.83 \mu\text{s}$. We can now determine that this switch will not be clean, because the two sources are on opposite sides of the limit and are therefore not in the same clean switch region.

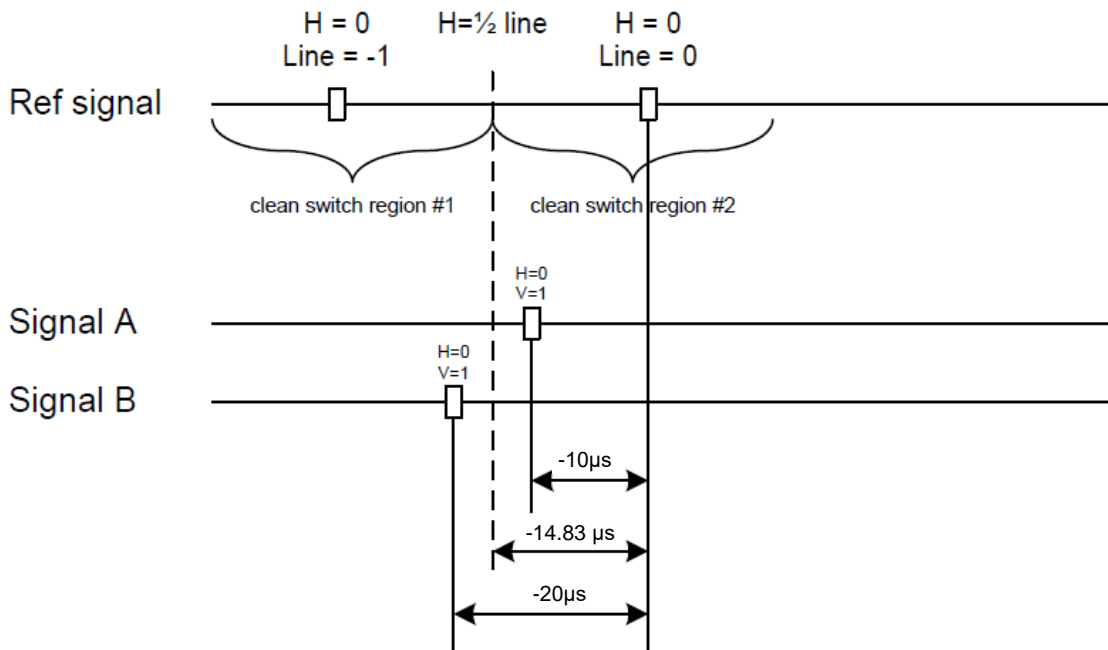

Figure 42– Clean Switch Regions Example 1

Example 2: We have two HD (1080i59) sources, one that indicates an offset of $30 \mu\text{s}$ with respect to the reference (A) and the other an offset of $20 \mu\text{s}$ (B). We know that a clean switch region limit is present at $+\frac{1}{2}$ line

and another one at $\frac{1}{2}$ line plus one line. These correspond to $14.83 \mu\text{s}$ and $44.48 \mu\text{s}$. We can now determine that this switch will be clean, because the two sources are inside the same clean switch region.

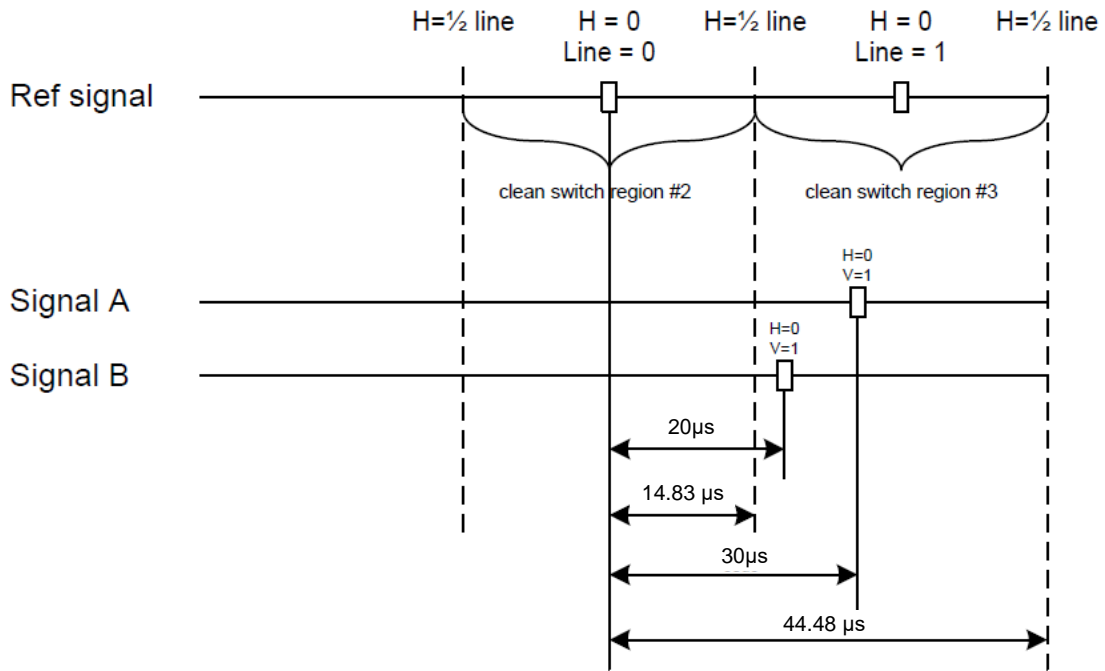

Figure 43– Clean Switch Regions Example 2

9.5 HDR Panel

The HDR panel has two tabs (**UC1** and **UC2 / DC1** and **DC2 / FS1** and **FS2**); one for each of XIP-3901-UC / -DC / -FS's independent processing channels. The configuration of the **UC2 / DC2 / FS2** tab is the same as the **UC1 / DC1 / FS1** tab. Only the configuration of the **UC1** tab is shown below as a representative example for all XIP-3901-UC / -DC / -FS applications.

9.5.1 UC1&2 / DC1&2 / FS1&2 Tabs

Grass Valley offers its own HDR processing. However, you can decide to use BBC LUTs or to load your own Custom LUTs. Furthermore, we can correct incoming VPID without applying any HDR conversion. Use the radio button to select the desired processing. Grass Valley HDR processing is selected by default.

Grass Valley BT.709 to BT2020 and BT.2020 to BT.709 are always available. Other video processing settings can be enabled for each channel by activating the **XIP-3901-UDC-HDR** option. See 9.9 - Options Panel for details about how to activate card options.



Figure 44–HDR UC1 / UC2 Tab (Shown on XIP-3901-UC)

Property	Description
Enable	Set to enable color space conversion and dynamic range conversion. When disabled, incoming color space and dynamic range are bypassed without processing. The Applied Conversion statuses will indicate "Bypass". You can change the HDR processing setting values even if processing is disabled, but processing will not be performed. Processing is disabled by default.
Grass Valley LUTs	Set the LUT to use for HDR processing. The following HDR processing setting are available as part of the Grass Valley LUTs : <ul style="list-style-type: none"> • BT.709 to BT.2020 • BT.2020 to BT.709 • SDR to HLG BT.2100 • SDR to PQ BT.2100 • HLG BT.2100 to SDR • PQ BT.2100 to SDR • PQ BT.2100 to HLG BT.2100 • HLG BT.2100 to PQ BT.2100 • S-Log3 S-Gamut3 to BT.709 800% • S-Log3 S-Gamut3 to HLG BT.2100 • S-Log3 S-Gamut3 to PQ BT.2100
BBC LUTs	Set the LUT to use for HDR processing. The following HDR processing setting are available as part of the BBC LUTs : <ul style="list-style-type: none"> • SDR to HLG Scene (4-1a - v1.4) • SDR to HLG Scene Strict (4-2a - v1.4) • SDR to HLG Scene Upmap (6-1a - v1.4) • SDR to HLG Scene Upmap Strict (6-2a - v1.4) • SDR to HLG Display (3c - v1.4) • SDR to HLG Display Upmap (5c - v1.4) • HLG to SDR Scene (12-1c - v1.4) • HLG to SDR Scene Strict (12-2c - v1.4) • HLG to SDR Display (8c - v1.4) • HLG to SDR Display Harsh (9c - v1.4) • PQ 1000 Nits Full Range to HLG (1c - v1.4) • PQ 1000 Nits Narrow Range to HLG (1e - v1.4) • PQ 4000 Nits Full Range to HLG (2c - v1.4) • PQ 4000 Nits Narrow Range to HLG (2e - v1.4) • HLG to PQ 1000 Nits Narrow range (7c - v1.4) • SLog3 100% Scene to HLG (10a - v1.4) • SLog3 200% Scene to HLG (11a - v1.4) • Unity
Custom LUTs	Set the LUT to use for HDR processing. You can pre-load up to 8 custom HDR conversions on the card. These are configured in the Custom LUTs tab.
Only force colorimetry fields in VPID/SDP	Set to force the use of a VPID. Sometimes, incoming HDR processing is not flagged properly on VPID. You can use this option to correct the outgoing VPID: <ul style="list-style-type: none"> • SDR BT.709 Narrow • HLG BT.2020 Narrow • PQ BT.2020 Narrow • PQ BT.2020 Full <p>Note: This application does not use SDP.</p>
HLG BT.2100 to SDR – Input HDR Ref White (nits)	Set the <i>reference white</i> luminance level in nits that will become 100% white in the SDR output. The value range must be between 100 and 1000 nits. The default value is 203 nits. This parameter is only applied when the Grass Valley HLG BT.2100 to SDR LUT is selected.

Property	Description
SDR to HLG BT.2100 – Output HDR Ref White (nits)	Set the <i>reference white</i> luminance level in nits for the HDR output that represents 100% white in the SDR input. The value range must be between 100 and 1000 nits. The default value is 203 nits. This parameter is only applied when the Grass Valley SDR to HLG BT.2100 LUT is selected.
PQ BT.2100 to SDR – Input HDR Ref White (nits)	Set the <i>reference white</i> luminance level in nits that will become 100% white in the SDR output. The value range must be between 100 and 1000 nits. The default value is 203 nits. This parameter is only applied when the Grass Valley PQ BT.2100 to SDR is selected.
PQ BT.2100 to SDR – Input Range	Set the input range to Full or Narrow : <ul style="list-style-type: none"> • Full: 0 to 1023 image mapping range according to SMPTE RP. 2077. • Narrow: The standard 64 to 940 image mapping broadcast range. This parameter is only applied when the Grass Valley PQ BT.2100 to SDR LUT is selected.
SDR to PQ BT.2100 – Output HDR Ref White (nits)	Set the <i>reference white</i> luminance level in nits for the HDR output that represents 100% white in the SDR input. The value range must be between 100 and 1000 nits. The default value is 203 nits. This parameter is only applied when the Grass Valley SDR to PQ BT.2100 LUT is selected.
SDR to PQ BT.2100 – Output Range	Set the output range to Full or Narrow : <ul style="list-style-type: none"> • Full: 0 to 1023 image mapping range according to SMPTE RP. 2077. • Narrow: The standard 64 to 940 image mapping broadcast range. This parameter is only applied when the Grass Valley SDR to PQ BT.2100 LUT is selected.
Colorimetry	Shows the applied conversion according to the above settings.
Transfer Characteristic	
Range	

9.5.2 Custom LUTs Tab

This tab allows you to load up to 8 custom LUTs (LUT1 to LUT8) that can be selected for use in the **UDC1/2** tabs. The XIP only supports files that conform to the Adobe Cube file v1.0 format. Custom LUTs are shared among all XIP applications. This feature requires the **XIP-3901-UDC-HDR** option. See 9.9 - Options Panel on page 75 for details about how to activate card options.

In order to use Custom LUTs, you first need to configure the Network tab. See 9.8 - Network Panel on page 73.

You can Load up to 8 LUTs. For each custom LUT you load, you need to specify input/output colorimetry, input/output range and output transfer characteristics.

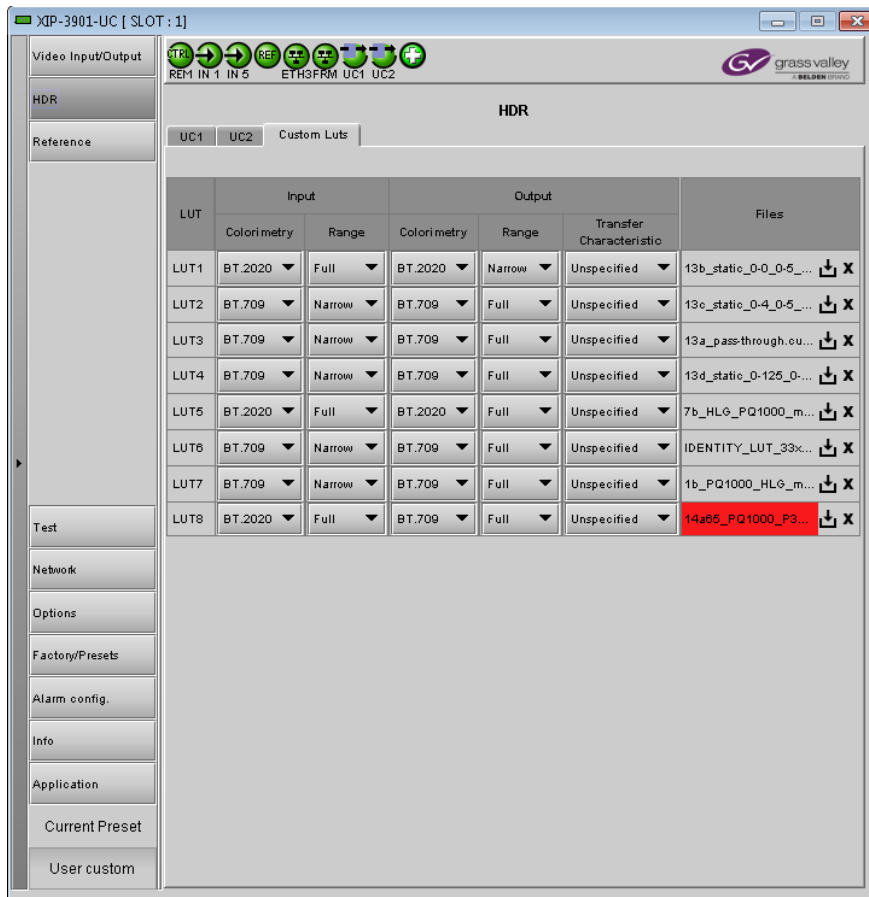

Figure 45–Custom LUTs Tab

Property	Custom LUTs Parameters	Available Values / Description
Input	Colorimetry	BT.709, BT.2020
	Input Range	Narrow, Full
Output	Colorimetry	BT.709, BT.2020
	Output Range	Narrow, Full
	Transfer Characteristic	SDR, HLG, PQ, Unspecified
Files	–	Click to upload or replace a LUT file. Click to remove the currently loaded LUT file. The name of the currently loaded LUT file will be partially displayed. Mouse-over the field to display the full name. The background will change to RED if the uploaded file is invalid.

9.6 Reference Panel

This panel is used to select the reference to be used by the XIP-3901 for synchronization.



Figure 46– Reference Panel (Shown on XIP-3901-UC)

Property	Description
Reference Presence	The icons show the presence and status of the various reference sources. For the external reference, the format is shown in the External Format window. Gray: There is no carrier or the carrier is not valid. Yellow: The carrier is present and is valid but its format is not supported. Green: The carrier is present and is valid and its format is supported.
External Format	Shows the current external reference format. The following shows which reference formats are supported: NTSC: Supported PAL: Supported 1080i 59 Hz: Unsupported 1080i 50 Hz: Unsupported 720p 59 Hz: Unsupported 720p 50 Hz: Unsupported

Property	Description
Selected Reference	<p>Shows which source is selected as a reference for each channel. The icons show whether the channel is locked to its reference or not.</p> <p>Gray: Locked on input, but the reference is not available.</p> <p>Green: Locked.</p> <p>Red: Missing, invalid, unsupported, or the channel is not locked to the selected reference.</p> <p>Note: If the selected reference is missing, invalid or unsupported, the SDI output(s) will be inactive (no carrier).</p>
Reference Source	<p>Use the radio buttons to select from the following settings:</p> <p>Auto (default): This mode selects the first source detected in this order of priority:</p> <ol style="list-style-type: none"> 1. External Reference input 2. URS 3. Input <p>External: Selects the signal connected to the rear panel REF IN connector.</p> <p>URS: Selects the Universal Reference Signal from the Densité frame's backplane.</p> <p>Input: Each path will lock on its SDI input:</p> <ul style="list-style-type: none"> • UC1/DC1/FS1 on SDI IN 1 • UC2/DC2/FS2 on SDI IN 2 <p>Note: On the XIP-3901-UC, you can enable 3G Output Minimum Delay for a 3G SDI Output in the Timing tab for a channel. On the XIP-3901-FS, you can enable Minimum Delay for a channel with the 12G/3G/HD and Quad Link 3G operation modes. In these cases, the reference source will be forced to Input for the channel (for the XIP-3901-UC, this will only occur if SDI input is 3G). For more information, see 9.1.2 - Timing Tab.</p>
URS Format	<p>Use the radio buttons in the URS Format area to select the URS mode:</p> <p>OFF (default): URS cannot be selected as the reference source and is ignored by the Auto detection mode. URS is grayed out in the Reference Source section of the user interface.</p> <p>URS 29.97 Hz: If Reference Source is set to URS, lock on 29.97 Hz.</p> <p>URS 25 Hz: If Reference Source is set to URS, lock on 25 Hz.</p>

9.7 Test Panel

You may activate the Color Bars & Tone test signal for the two channels independently by enabling the appropriate checkboxes.





Figure 47– Test Panel (Shown on XIP-3901-UC)

Property	Description
Color Bars & Tone	<p>Enables test signals at the card’s output:</p> <ul style="list-style-type: none"> Video: Generate a video test pattern. On HD Video outputs, this will generate a 75% color bar with 75% white. On 3G, Quad Link 3G and 12G Video outputs, test pattern will follow the format setting. In the XIP-3901 UC only, the 75% color bar is inserted as 3G/HD SDI and upconverted to 12G/3G/Quad Link 3G. Audio: Generate a 1 KHz sine wave at -18dBFS on all audio channel outputs: <ul style="list-style-type: none"> Continuous tone on right channel; pulsed tone on left channel of every pair (250 ms pulse every 3 seconds). Audio inserted on Quad Link 3G - link 1 only. Metadata: blank except for VPID on SDI output
Format	<p>Set video test pattern format for 3G, Quad Link 3G and 12G Video outputs:</p> <ul style="list-style-type: none"> SDR BT.709 (75%): 75% Color bar with 75% white HLG BT.2110-0: Test pattern HLG narrow range as per ITU-R BT.2111-0 PQ Narrow BT.2111-0: Test pattern PQ narrow range as per ITU-R BT.2111-0 PQ Full BT 2111-0: Test pattern PQ full range as per ITU-R BT.2110-0

Status

When Test mode is activated on a channel, the status icon display for that channel will show the Color Bars&Tone icon.

Test Pattern	Operating Mode	Icon
Enabled	Color Bars&Tone	
Disabled	Process	

9.8 Network Panel

The Network panel is used to set the network configuration of the ETH3 Ethernet port on the XIP-3901 and the bridged port through the Densité frame controller (FRM). These settings are shared by all UC, DC, and FS applications, since there is only one Ethernet port on the platform.

The ETH3 Ethernet port is used to perform firmware upgrades and to upload HDR Custom LUTs on the XIP-3901 only if the card is installed in a Densité 3+FR1 or Densité 3+FR4 frame with a CPU-ETH3 Basic controller. When the card is installed in a Densité 3+FR4 frame with a CPU-ETH3 Standard or Advanced controller, the firmware upgrade is performed using the frame controller’s Ethernet port and HDR Custom LUTs can be uploaded through the bridged port through the Densité frame controller (FRM).



Figure 48– Network Panel (Shown on XIP-3901-UC)

Property	Description
Hostname	Set a unique network identification label by which this device will be known. Only alpha-numeric characters and the hyphen are permitted.
Domain Name	Shows the name of the domain(s) the card is part of. At least one interface must be configured with DHCP in order to be able to receive this information.
DNS Servers	Shows the addresses of the name resolution servers. At least one interface must be configured with DHCP in order to be able to receive this information.

Property	Description
Control Port ETH3, Control Port Frame (FRM)	The FRM port is a bridged port through the Densité frame controller. The physical frame controller's Ethernet port must be connected to the network for this interface to work. Note: The FRM port address must not contain any of the frame controller's IP addresses. Control ports can be used for firmware upgrades: <ul style="list-style-type: none"> If the card is installed in a Densité 3+FR1 or Densité 3+FR4 frame with a CPU-ETH3 Basic controller, the ETH3 port must be used. Note: Before upgrading through the ETH3 port, you will need to configure ETH3 through local menu or install the iControl bundle for the current firmware version in order to configure ETH3. Once ETH3 has been configured, you will be able to upgrade/downgrade the card and its iControl bundle. If the card is installed in a Densité 3+FR4 frame with a CPU-ETH3 Standard or Advanced controller, the firmware upgrade is performed using the frame controller's Ethernet port (FRM).
Mode	Set the mode to assign an IP address to an Ethernet port. Off: Ethernet port disabled, it will not be used. Auto (DHCP): Ethernet port enabled with automatic configuration using a network's DHCP server. Static: Ethernet port enabled with static user specified configuration (IP Address, Subnet Mask, and Gateway).
IP Address	When Mode is set to Static , set the card's IP address.
Subnet Mask	When Mode is set to Static , set the subnet mask for your network.
Gateway	When Mode is set to Static , set the network switch's IP address.
MAC address	Shows the Ethernet port's MAC Address.
LLDP	Shows the Link Layer Discovery Protocol (LLDP) TLV values. LLDP is used to advertise the identity, capabilities, and neighbors on a LAN. Click Details for any one Ethernet port to view the LLDP TLV values. See Figure 49.
Test Address	Test the IP connectivity to a device (on the same network) from any one Ethernet port for troubleshooting purposes. Enter the device's IP address and click Ping . In Status , a message shows the ping's IP connectivity status.
Apply Cancel	When active, this applies or rejects your current changes. Pending changes are displayed in red.

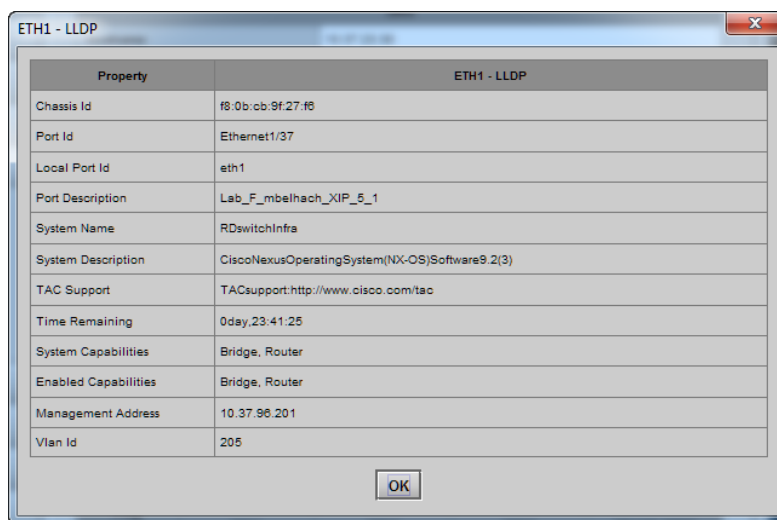

Figure 49– Network ETH LLDP Properties

9.9 Options Panel

There is one option available for the XIP-3901:

- XIP-3901-UDC-HDR:** Enables the card's HDR conversion function. This option is shared by all applications; for example, when activated on a XIP-3901-UC application, it will also be activated on any XIP-3901-DC and XIP-3901-FS applications. When this option is activated, all HDR conversion settings are available. When it is not activated, only the BT.709 to BT.2020 and BT.2020 to BT.709 settings are available. See 9.5 - HDR Panel to see all settings available with this option.

To activate this option, you must:

1. Obtain a license key for the option from Grass Valley.
2. Open the Options panel and select the appropriate tab.
3. Type the license key in the Enter key box.
4. Click **Enable option** to enable the option's features.

Once the option is activated, the status box beneath the Enter key area will show the status as active, with a green background.

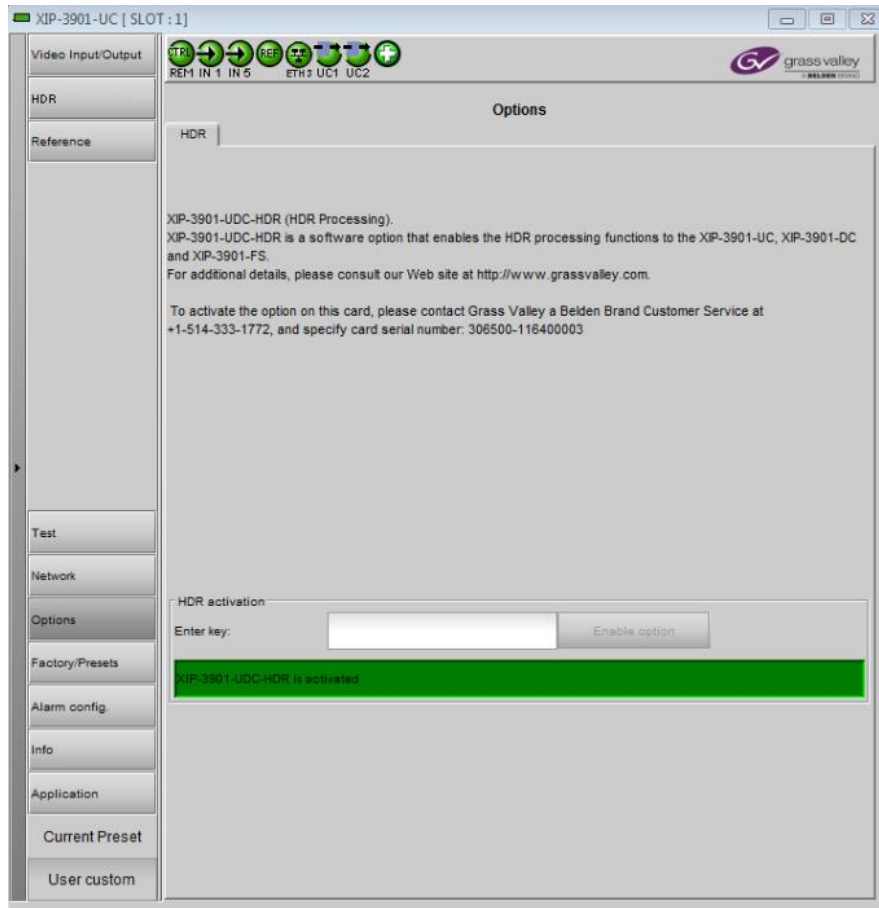

Figure 50– Options Panel (Shown on XIP-3901-UC)

10 Configuring the XIP-3901-UDC-IP Application Using iControl

This section describes the control panels associated with the XIP-3901-UDC-IP application and their use.

10.1 Network Panel

The Network panel is used to set the network configuration of the media and control Ethernet ports on the XIP-3901-UDC-IP. ETH1 and ETH2 are media ports and ETH3 and FRM are control (management) ports.

- Media ports manage PTP, video, metadata, and audio streams, as well as NMOS IS-04 and IS-05 also.
- Control ports manage card upgrade as well as NMOS IS-04 and IS-05 also.

10.1.1 Interface Tab

This tab allows you to configure the network settings for media and control ports.



Figure 51 – Network Interface Tab

Property	Description
Hostname	Set a unique network identification label by which this device will be known. Only alphanumeric characters and the hyphen are permitted.

Property	Description
Domain Name	Shows the name of the domain(s) the card is part of. At least one interface must be configured with DHCP in order to be able to receive this information.
DNS Servers	Shows the addresses of the name resolution servers. At least one interface must be configured with DHCP in order to be able to receive this information.
Media Port ETH1 and ETH2	The media ports support PTP, video, metadata, and audio streams and can be used for NMOS IS-04/IS-05 (see 10.3 - NMOS Panel on page 83).
Control Port ETH3 Control Port Frame (FRM)	<p>The FRM port is a bridged port through the Densité frame controller. The physical frame controller's Ethernet port must be connected to the network for this interface to work. Note: The FRM port address must not contain any of the frame controller's IP addresses. Control ports can be used for firmware upgrades:</p> <ul style="list-style-type: none"> • If the card is installed in a Densité 3+FR1 or Densité 3+FR4 frame with a CPU-ETH3 Basic controller, the ETH3 port must be used. Note: Before upgrading through the ETH3 port, you will need to configure ETH3 through the frame's local menu or install the iControl bundle for the current firmware version in order to configure ETH3. Once ETH3 has been configured, you will be able to upgrade/downgrade the card and its iControl bundle. • If the card is installed in a Densité 3+FR4 frame with a CPU-ETH3 Standard or Advanced controller, the firmware upgrade is performed using the frame controller's Ethernet port (FRM). <p>Control ports can also be used for NMOS IS-04 and IS-05. If both control ports are enabled and in the same subnet as the NMOS registry, the FRM port will be used.</p>
Mode	<p>Set the mode to assign an IP address to an Ethernet port.</p> <p>Off: Ethernet port disabled, it will not be used.</p> <p>Auto (DHCP): Ethernet port enabled with automatic configuration using a network's DHCP server.</p> <p>Static: Ethernet port enabled with static user specified configuration (IP Address, Subnet Mask, and Gateway).</p>
IP Address	When Mode is set to Static , set the card's IP address.
Subnet Mask	When Mode is set to Static , set the subnet mask for your network.
Gateway	When Mode is set to Static , set the network switch's IP address.
MAC address	Shows the Ethernet port's MAC Address.
LLDP	Shows the Link Layer Discovery Protocol (LLDP) TLV values. LLDP is used to advertise the identity, capabilities, and neighbors on a LAN. Click Details for any one Ethernet port to view the LLDP TLV values. See Figure 49.
Test Address	Test the IP connectivity to a device (on the same network) from any one Ethernet port for troubleshooting purposes. Enter the device's IP address and click Ping . In Status , a message shows the ping's IP connectivity status.
Apply Cancel	When active, this applies or rejects your current changes made in this tab. Pending changes are displayed in red.

10.1.2 SFP Tab

The SFP tab shows the media ports' SFP cartridge status.

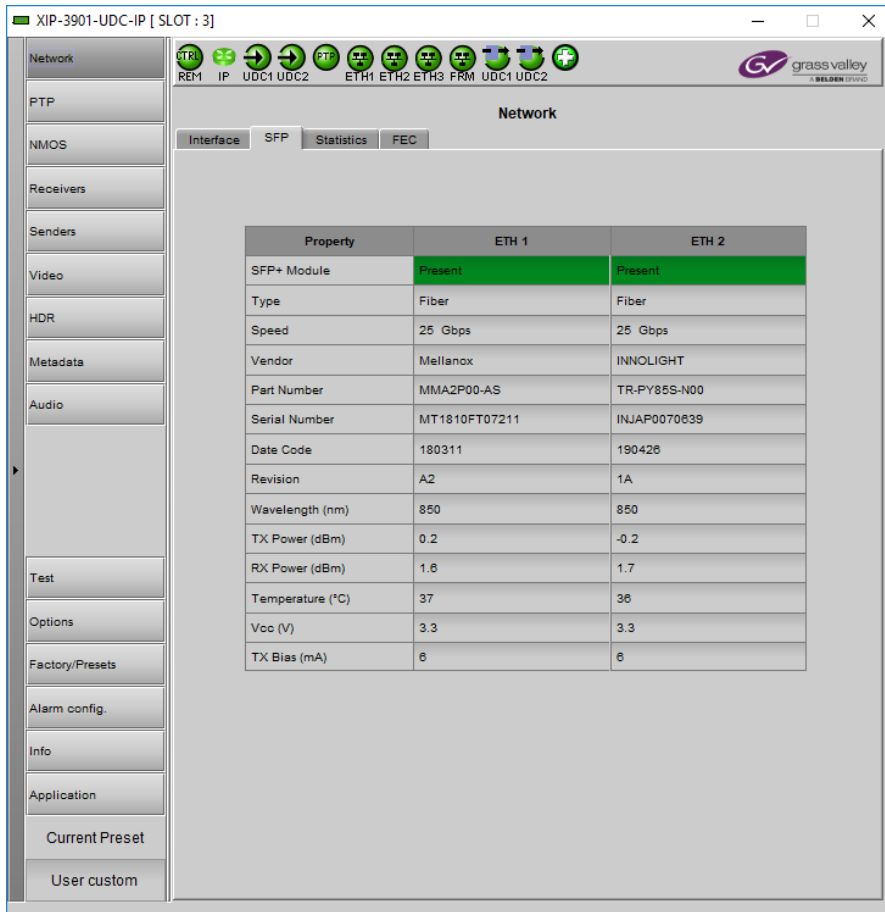

Figure 52 – Network SFP Tab

Property	Description
SFP+ Module	The current status of the SFP+ module. Green: SFP module detected Grey: SFP mode not detected
Type	The connection media type.
Speed	The connection speed
Vendor	Manufacturer's information about the SFP+ module.
Part Number	
Serial Number	
Datacode	
Revision	

Property	Description
Wavelength	These are values from the SFP's Diagnostic Monitoring Interface (DMI). The background color changes according to the current state: Green: low/high warning flags Red: low/high alarm flags Grey: current state is normal
TX Power	
RE Power	
Temperature	
Vcc	
TX Bias	

10.1.3 Statistics Tab

The SFP tab shows the data transmission and reception statistics for the media ports. This information can be used to see the level of network utilization and to know if the level of media traffic is at or near the rated network bandwidth. A saturated network will result in packet loss at the receiver.



Figure 53 – Network Statistics Tab

When Reset is clicked, the current date and time is shown as a record of how long the packet counters have been running.

10.1.4 FEC Tab

This tab allows you to configure the media network’s error correction scheme for **ETH 1** and **ETH 2**.

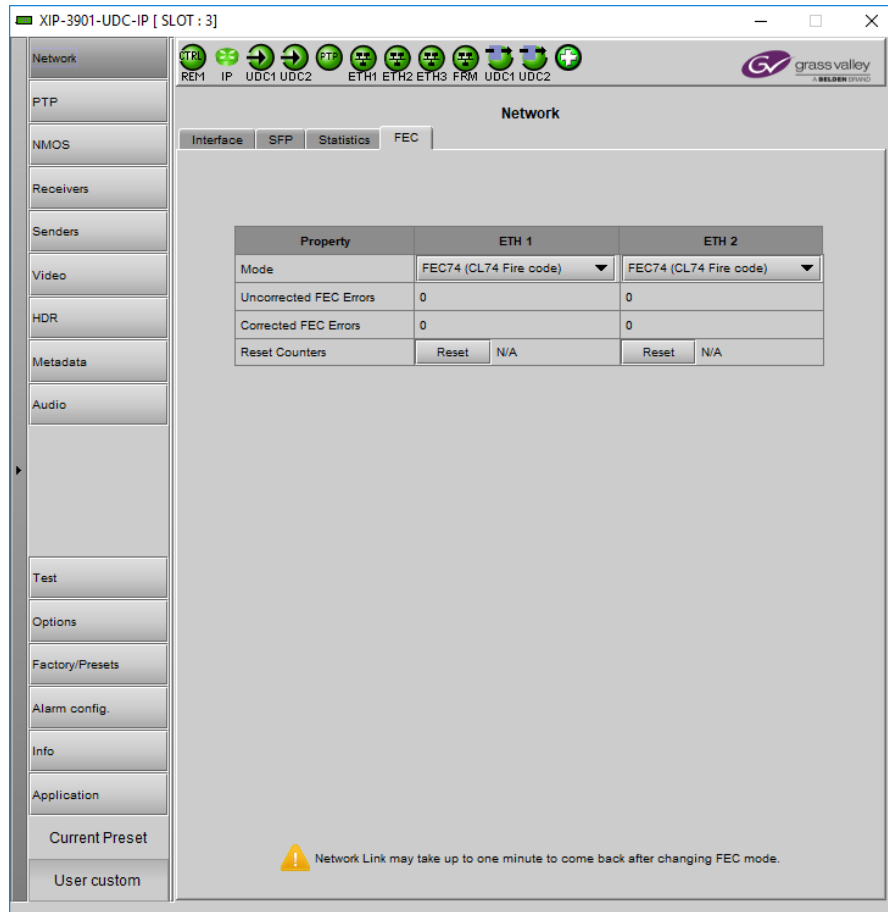

Figure 54 – Network FEC Tab

Property	Description
Mode	<p>The error correction mode:</p> <ul style="list-style-type: none"> • Off: No error correction is used. • FEC74: Applies IEEE 802.3 Clause 74 Fire Code Forward Error Correction. • FEC108: Applies IEEE 802.3 Clause 108 Reed Solomon Forward Error Correction. <p>Corresponding equipment sending or receiving these media streams must also be configured with the same error correction method. Otherwise the link will fail.</p>
Uncorrected FEC Error Corrected FEC Error	<p>The current number of detected errors at the physical layer.</p> <ul style="list-style-type: none"> • Corrected errors are errors that the FEC algorithm was able to remove. • Uncorrected errors are errors that the FEC algorithm was unable to remove as the bit stream is too damaged. <p>NOTE: The error counters only work when the Mode is set to FEC108 or FEC74.</p>
Reset Counter	<p>Clear the number of errors shown above. When Reset is clicked, the current date and time is shown as a record of how long the corresponding error counter has been running since the last reset.</p>

10.2 PTP Panel

To allow vertically accurate video frame synchronization, multicast Precision Timing Protocol (described in IEEE Standard 1588) is used to distribute time across a packet network. It is used on both media ports (ETH1 and ETH2) for BMCA redundancy. This supports Best Master Clock Algorithm (BMCA) as per IEEE-1588-2008. The XIP-3901-UDC-IP supports:

- SMPTE 2059-2; locks the inputs and outputs on PTP
- AES-67 profiles
- one-step and two-step synchronization mode automatically
- End-to-End Delay mechanism.
- Multicast PTP only

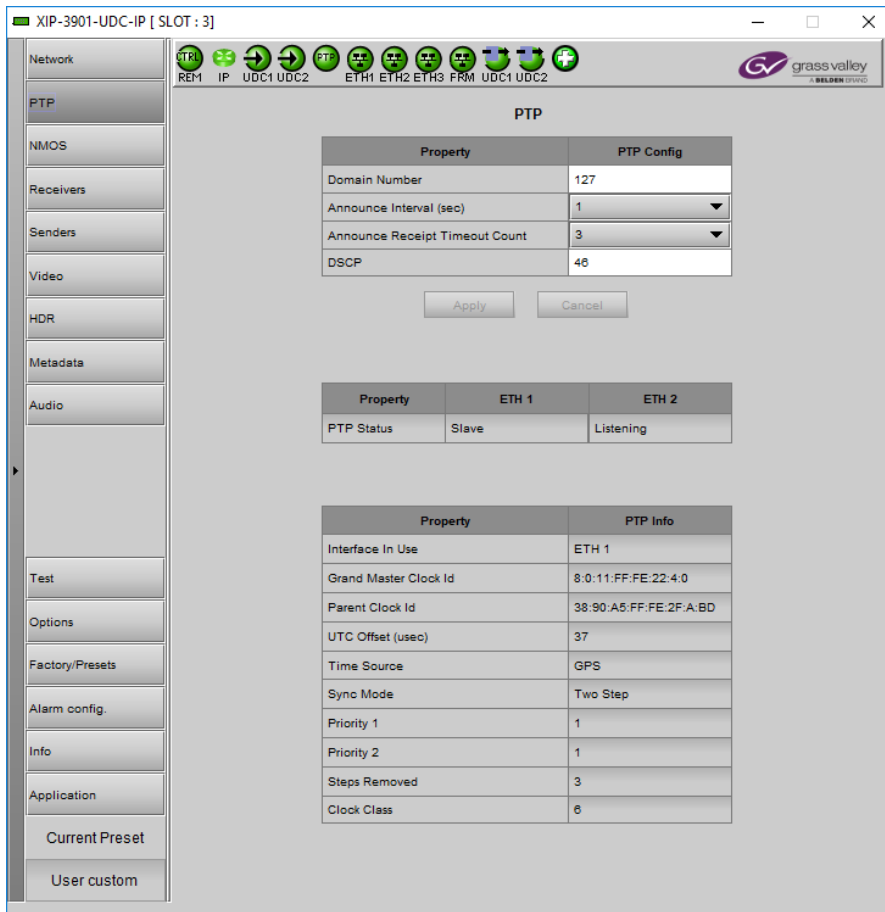

Figure 55 – PTP Panel

Property	Description
Domain Number	Specify the PTP Domain Number the card is to use to synchronize its clock. A domain is an interacting set of clocks that synchronize to one another using PTP. Clocks are assigned to a domain by virtue of the contents of the Subdomain name or the domain Number (IEEE 1588-2008) fields in PTP messages they receive or generate. The range is 0 to 127. The default value is 127.

Property	Description
Announce Interval	Specify the Announce message interval used by the parent clock (Boundary clock). Announce Interval range is: 0.125, 0.250, 0.500, 1, 2, 4, 8, 16 seconds. The default value is 0.125 second.
Announce Receipt Timeout Count	Specify the Announce Receipt Timeout used by the parent Boundary clock. The Announce Receipt Timeout range is 2 to 10 seconds. The default value is 3 seconds.
DSCP	Sets the quality of service priority for outgoing PTP packets. The range is 0 to 63. The default value is 46.
PTP Status ETH1 & ETH2	Shows the status of the ETH interfaces. The possible values are: Faulty: The protocol's fault state. Listening: The port is waiting for the announceReceiptTimeout to expire or to receive an Announce message from a master. Uncalibrated: One or more master ports have been detected in the domain. Slave: The port is synchronized to the selected master port.
Interface In Use	Shows the interface that is currently receiving PTP (ETH1, ETH2).
Grand Master ID	Shows the Grand Master's ID (for example, Tektronix).
Parent Master ID	Shows the Boundary clock's ID (Switch ID).
UTC Offset (sec)	Shows the current time offset between UTC and PTP. This value can change. The possible range is -32768 to 32767.
Time Source	Shows the source of time used by the grandmaster clock. The possible values are Atomic Clock, GPS, Terrestrial Radio, PTP, NTP, Hand Set, Other, Internal Oscillator.
Sync mode	Shows the Sync Mode from the Grand Master. A boundary clock cannot have a different setting. The possible values are One Step, Two Step.
Priority 1	Shows the first priority. This is used in the execution of the Best Master Clock Algorithm (BCMA). The possible values are 0 to 255.
Priority 2	Shows the second priority. This is used in the execution of the Best Master Clock Algorithm (BCMA). The possible values are 0 to 255.
Step Removed	Shows how many hops the card is from the Grandmaster. This is used by the Best Master Clock Algorithm (BCMA). The possible values are 0 to 65535.
Clock Class	Shows the clockClass attribute of an ordinary or boundary clock. This denotes the traceability of the time or frequency distributed by the grandmaster clock. The possible values are 0 to 255.

10.3 NMOS Panel

XIP-3901-UDC-IP supports Networked Media Open Specifications (NMOS) AMWA IS-04 for device discovery and registration and IS-05 for connection management. Furthermore, it supports AMWA BCP-002 recommendations for Grouping NMOS Resources.

XIP-3901-UDC-IP relies on an external NMOS registry that is used to register NMOS devices. You must point XIP-3901-UDC-IP to this external NMOS registry.

PREREQUISITE: A working NMOS registry service must be available on the network.

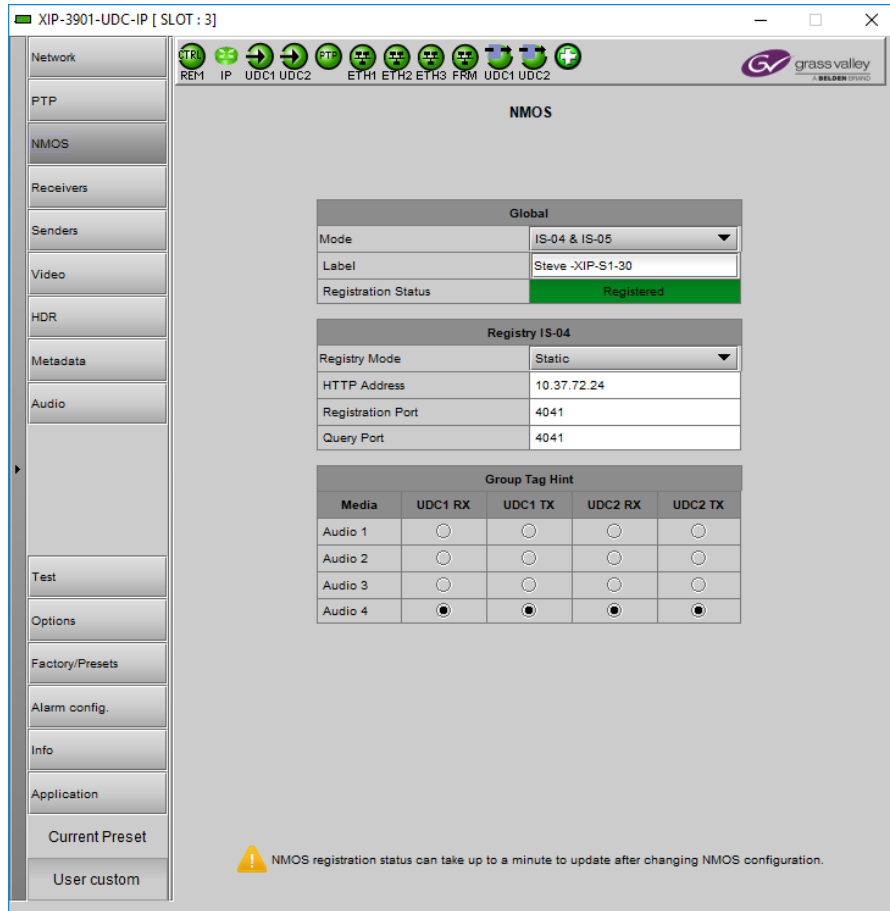

Figure 56 – NMOS Panel

Property	Description
Mode	Set the NMOS mode: IS-04: enable the Networked Media Open Specifications (NMOS) IS-04 v1.2 or higher for device discovery and registration. All senders will publish and update SDP file, but receivers can't be updated. IS-04 & IS-05: enable the NMOS IS-04 for device discovery and registration and IS-05 for connection management. All senders will publish and update an SDP File and receivers will accept routing request and process the received SDP file. OFF: disable NMOS. This eliminates the RED status when NMOS IS-04 is not used. This is the default.
Label	Set the identifier by which this XIP-3901-UDC-IP card will be known in the NMOS registry, and by extension, to other NMOS devices using this NMOS registry.

Property	Description
Registration Status	Shows if the card has successfully registered itself in the NMOS registry. Green: the card has successfully registered itself with the NMOS registry. Red: the card is not yet registered with the NMOS registry. Grey: NMOS is disabled (Mode is OFF).
Registry IS-04, Registry Mode	Set the IS-04, Registry Mode: Auto: automatic discovery of the NMOS registry using DNS Service Discovery (DNS-SD), as described in AMWA IS-04 NMOS Discovery and Registration Specification v1.2. Static: manually specified NMOS registry values for address, registration port and query port. In this mode, by specifying a registry address in the same subnet as one of the interfaces, the interface will be used. However, when specifying an address in a different subnet, the first available interface will be used in the following order: FRM, ETH3, ETH1 , and then ETH2 . The default Registry Port value is 3210. The default Query Port value is 3211.
HTTP Address	Set the NMOS registry's IP Address when the Registry IS-04, Registry Mode is Static .
Registration Port	Set the NMOS registry's registration port number when the Registry IS-04, Registry Mode is Static .
Query Port	Set the NMOS registry's query port number when the Registry IS-04, Registry Mode is Static .
Group Tag Hint	Set which audio receiver/sender to include in the Group Hint Tag. By Default GV Convergent creates logical source/destination groups with only one audio stream. If you want to have more audio receivers in a source/destination group, you will have to create them manually in GV Convergent.

10.4 Receivers Panel

The Receivers panel has two tabs (**UDC1** and **UDC2**); one for each of XIP-3901-UDC-IP’s independent processing channels. The configuration of the **UDC2** tab is the same as the **UDC1** tab. Only the configuration of the **UDC1** tab is shown below.

10.4.1 Config Tab

This tab allows you to configure the expected source media’s audio channels, stream address, port, and IGMPv3 source. The receivers are ST 2110-30 (Audio 1, Audio 2, Audio 3, and Audio 4). The receivers are SMPTE ST 2110-20 (Video), ST 2110-40 (Meta 1), and ST 2110-30 (Audio 1, Audio 2, Audio 3, And Audio 4).

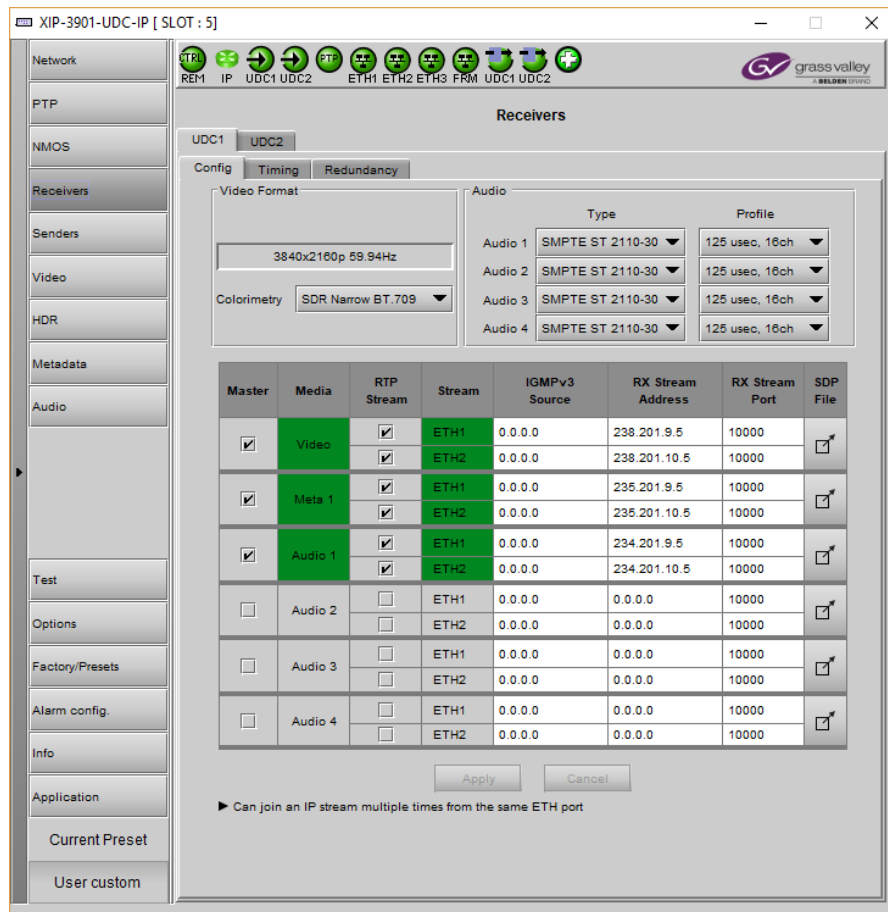

Figure 57 – Receivers Config Tab

Property	Description
Video Format	Shows the video source stream's format (resolution / frame rate).
Colorimetry	Shows the colorimetry and TCS information extracted from the associated SDP file for the selected SMPTE 2110 stream allowing for a constant update between a sender and a receiver. In the absence of valid SDP contents, use the dropdown list to manually set the stream colorimetry type.
Audio	<p>Type: Use the pull-down to set the audio source stream's type for streams Audio 1 to Audio 4.</p> <ul style="list-style-type: none"> • Type SMPTE ST 2110-30: for PCM linear audio (AES67 compatible) • Type SMPTE ST 2110-31: for transparent transport of non-linear audio and data formats: provides bit-transparent AES3 over IP <p>Profile: Use the pull-down to set the audio profile for streams Audio 1 to Audio 4. Audio receivers support Level C as per SMPTE 2110-30/31: 48kHz stream from 1 to 8 channels (1 to 4 for SMPTE 2110-31) at packet times of 1ms and 1 to 64 channels (1 to 60 for SMPTE 2110-31) at packet time of 125us.</p> <p>These settings can also be managed by external NMOS control. See 10.3 - NMOS Panel on page 83.</p>
Master	Set to enable a media receiver. This manages the Join/Release of both the primary and secondary streams. These settings can also be managed by external NMOS control. See 10.3 - NMOS Panel on page 83.
Media	Shows the stream type. The background shows the current media status: Green: no error Red: error Grey: inactive
RTP Stream	Set to enable each stream receiver individually (primary and secondary).
Stream	Shows the primary (ETH1) and secondary (ETH2) stream receiver status: Green: no error Red: error Grey: inactive
IGMPv3 Source	Set the source from which to receive multicast streams. With this protocol, the card deals with a switch to subscribe to one or many streams that are coming from different sources. Both iGMPv3 and iGMPv2 protocols are supported. Set this to 0.0.0.0 if iGMP source is not used. The source range is 0.0.0.0 to 255.255.255.255. The default value is 0.0.0.0. These settings can also be managed by external NMOS control. See 10.3 - NMOS Panel on page 83.
RX Stream Address	Set the IP address and UDP port number at which this card receives a specific stream. IP address 0.0.0.0 disables a receiver. The default UDP port values are:
RX Stream Port	<ul style="list-style-type: none"> • 10000 for all media receivers. <p>These settings can also be managed by external NMOS control. See 10.3 - NMOS Panel on page 83.</p>
SDP File	Click to show the last SDP file received through NMOS IS-05 since the last bootup. This window does not refresh automatically; you need to close and re-open the window to see an update. If the card has never received an SDP file since last its last bootup, the window will be empty.
Apply Cancel	When active, this applies or rejects your current changes made in this tab except for Audio type and Profile

10.4.2 Timing Tab

This tab allows you to view the network health of the stream's connection (link latency, receiver buffer level, and offset time).

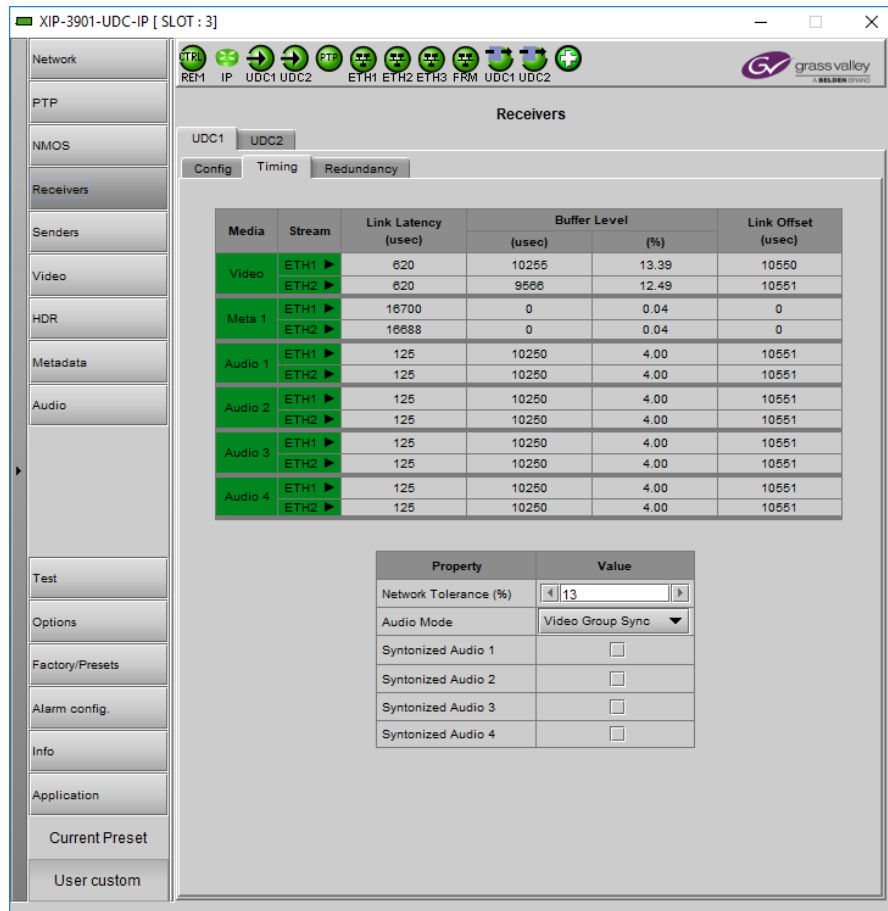

Figure 58 – Receivers Timing Tab

Property	Description
Media	Shows the stream type. The background shows the current media status: Green: No error Red: Error Grey: Inactive
Stream	Shows the primary (ETH1) and secondary (ETH2) stream receiver status: Green: No error Red: Error Grey: Inactive
Link Latency	Shows the time it takes for a packet to come from the source to the receiver. This measurement represents the difference between incoming RTP timestamp and PTP time before the receiver's buffer.
Buffer level	Shows the amount of preloaded data stored in the receiver that is ready for use in microseconds and in percentage. The current buffer level in microseconds shows the minimum latency required to receive a continuous stream. The current buffer level in percentage shows how much of the internal buffering is used to receive the current stream.

Property	Description
Link Offset	Shows the resulting link latency after being read out from receiver's buffer. This measurement is the difference between the packet RTP timestamp and the PTP time after the receiver's buffer and represents the total reception delay. Video, Metadata, and audio link offset depends on the selected Network Tolerance. Moreover, Audio link offset can also depend on the currently-selected Audio Mode.
Network Tolerance	Network Tolerance is directly related to the current operating level of the video receiver's buffer. That is, the bigger the value, the greater the buffer usage will be. Additional latency is then introduced as a result, thus giving a better tolerance to packet distribution and network jitter. SMPTE ST 2022-7 Class A, wide source or software-based sources can then be received without errors. To optimize this parameter, start with the smallest Network Tolerance and increase it until video, metadata, and audio streams statuses become GREEN. NOTE: Metadata streams are automatically synchronized to the video. Incoming metadata streams should not be delayed by more than one frame with respect to the video to be properly synchronized. If the metadata stream is delayed by more than one frame, then it is going to be delayed by one frame. Use the Link Offset measurement to monitor this condition.
Audio Mode	Video Group Sync: Audio is synchronized with the video stream. You might have to add more Network Tolerance until the audio Receiver Stream Statuses are GREEN in order to be able to receive audio streams that are delayed. Audio streams are synchronized to the video based on the RTP Timestamp. Audio Group Sync: Audio reception is done without regard to video synchronization. Audio buffer level is set automatically based on incoming Link Latency measures of all audio streams. A common link offset value will be selected based on the highest received link latency (except those in synchronized mode). It will keep the worst measured link latency since a stream was enabled, after a PTP disturbance or bootup. To force a recalculation of the link offset, disable/enable one of your received streams.
Syntonized Audio 1 to 4	Set to ignore Audio RTP timestamps. Audio buffer reception is then fixed to 25%. Use these settings to manage audio streams that are not properly time stamped. Enable syntonize for audio 1 to 4 individually.

10.4.3 Redundancy Tab

This tab allows you to view the reception state regarding SMPTE ST 2022-7 redundancy. The primary and secondary streams, at the packet level, will work together in order to produce a valid resulting stream. To achieve redundancy, both streams need to be in range with respect to the receiver buffer. Adjustments can be done by applying a bigger Network Tolerance if need be (see 10.4.2 - Timing Tab on page 87). In the circumstance in which only one stream is successfully received, the resulting stream will be valid as well but without any active redundancy protection.

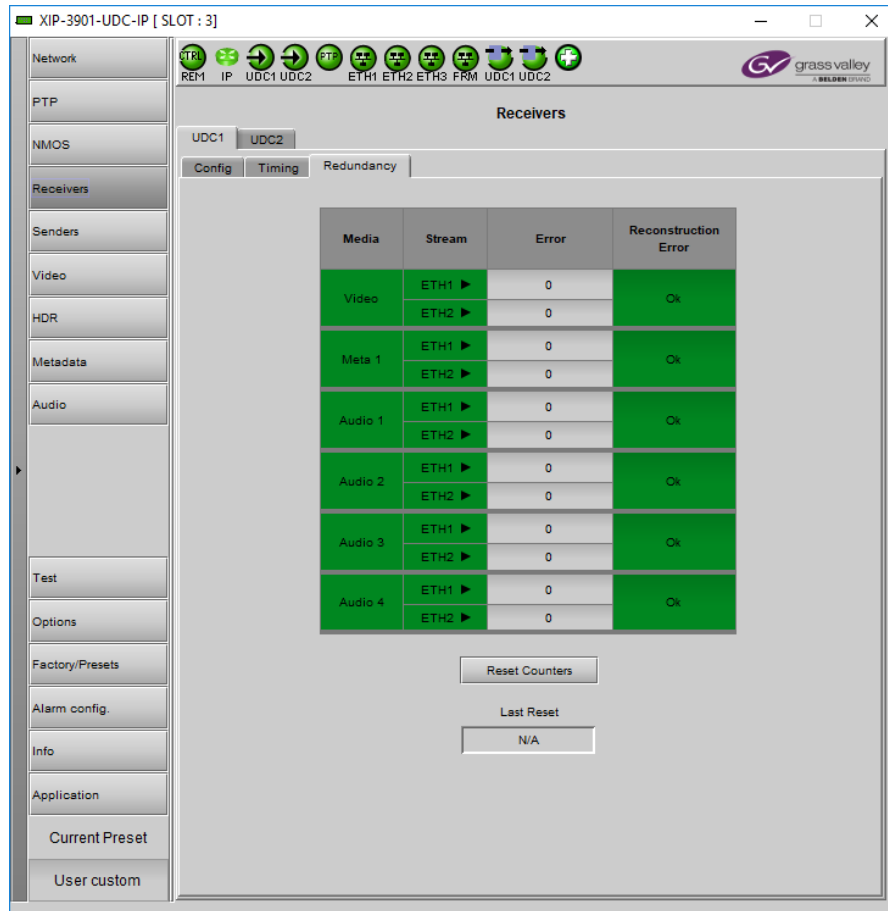

Figure 59 – Receivers Redundancy Tab

Property	Description
Media	The background shows the current media status: Green: No error Red: Error Grey: Inactive
Stream	Shows the primary (ETH1) and secondary (ETH2) stream receiver status: Green: No error Red: Error Grey: Inactive
Error	Shows the number of packets in error that will required SMPTE 2022-7 reconstruction for each Ethernet port.
Reconstruction Error	Shows if the redundant stream was successful at maintaining signal integrity for the previous 5 seconds, when primary (ETH1) and secondary (ETH2) ports are enabled.
Reset Counters	Clears the number of errors shown above. When Reset is clicked, the current date and time is shown as a record of how long the error counters have been running since the last reset.

10.5 Senders Panel

The Senders panel has three tabs (**GB1**, **GB2**, and **Advanced**); **GB1** and **GB2** are for each of XIP-3901-UDC-IP’s independent processing UHD channels. These tabs configure the SMPTE ST 2110 outputs. The configuration of the **UDC2** tab is the same as the **UDC1** tab. Only the configuration of the **UDC1** tab is shown below.

Each channel can:

- Send one SMPTE 2110-20 video stream
- Send full ancillary space on one SMPTE 2110-40 metadata stream
- Send 4 audio streams
 - Audio 1 can send up to 64 processed audio channels
 - Audio 2 to 4 can send up to 64 audio channels, but only audio channel 1 to 16 can be processed audio channels. Audio channels 17 to 64 will contain silence.

Statuses confirm that the RTP stream is successfully streaming.

10.5.1 UDC1 / UDC2 Tabs

This tab allows you to configure the destination media’s video format, audio channels, stream IP addresses and port numbers.

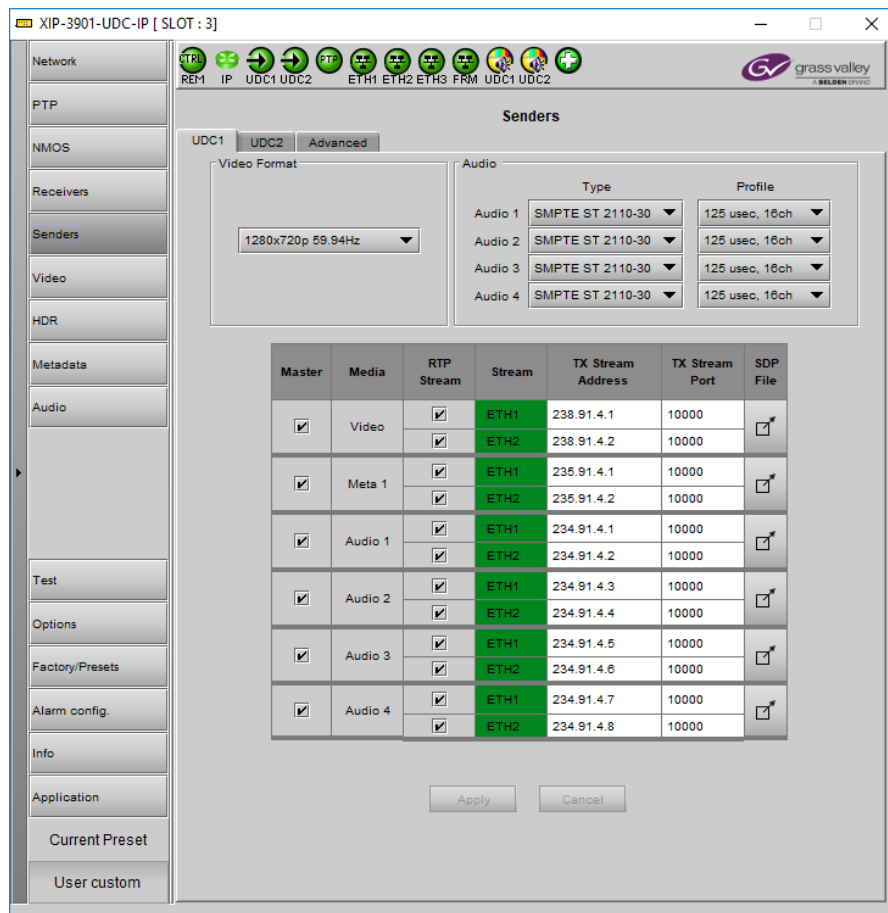

Figure 60 – Senders Config Tab

Property	Description
Video Format	Use the pull-down to set the video format for the destination (resolution / frame rate).
Audio	<p>Type: Use the pull-down to set the audio stream’s type for streams Audio 1 to Audio 4.</p> <ul style="list-style-type: none"> • Type SMPTE ST 2110-30: for PCM linear audio (AES67 compatible) • Type SMPTE ST 2110-31: for transparent transport of non-linear audio and data formats. Provides bit-transparent AES3 over IP. <p>Profile: Use the pull-down to set audio profile for streams Audio 1 to Audio 4. Audio receivers support Level C as per SMPTE 2110-30/31: 48kHz stream from 1 to 8 channels (1 to 4 for SMPTE 2110-31) at packet times of 1ms and 1 to 64 channels (1 to 60 for SMPTE 2110-31) at packet time of 125us.</p> <p>These settings can also be managed by external NMOS control. See 10.3 - NMOS Panel on page 83.</p>
Master	Set to enable a media sender. This manages both the primary and secondary streams. This can also be managed by external NMOS control. See 10.3 - NMOS Panel on page 83.
Media	Shows the stream type.
RTP Stream	Set to enable a media stream sender for primary and secondary. This can also be managed by external NMOS control. See 10.3 - NMOS Panel on page 83.
Stream	Shows the primary (ETH1) and secondary (ETH2) streaming status: Green: streaming Red: not streaming Grey: not active
TX Stream Address	Set the IP address and UDP port number of the outgoing stream. IP address 0.0.0.0 disables a sender. The default UDP port values are 10000.
TX Stream Port	Address & UDP port can also be managed by external NMOS control. See 10.3 - NMOS Panel on page 83.
SDP File	Click to show the last SDP file transmitted through NMOS since the last bootup. This window does not refresh automatically; you need to close and re-open the window to see an update. If the card has never received an SDP file since its last bootup, the window will be empty.
Apply Cancel	When active, this applies or rejects your current changes made in this tab except for Audio Type and Audio Profile

10.5.2 Advanced Tab

This tab allows you to configure the outgoing payload type and DSCP priority for SMPTE 2110-20 (Video), SMPTE 2110-40 (Meta 1) and SMPTE 2110-30/31 (Audio 1 to Audio 4). These setting apply to both UDC1 and UDC2 tabs.

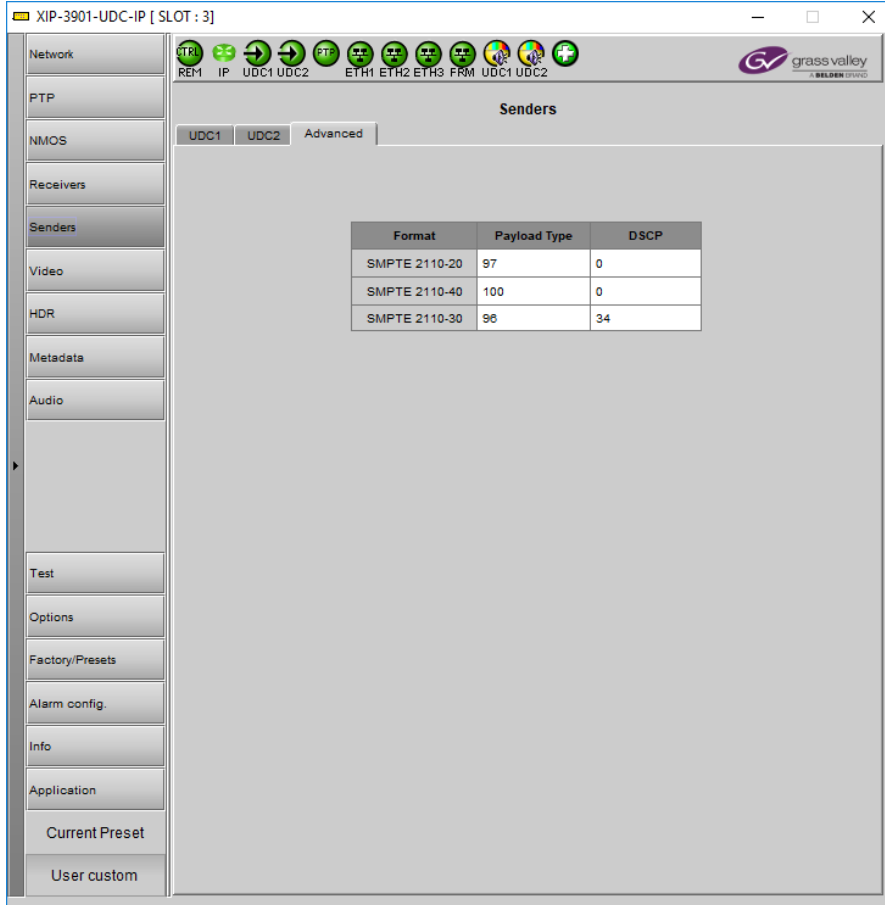

Figure 61 – Senders Advanced Tab

Property	Description
Payload Type	<p>Sets the RTP Payload ID value of outgoing video, metadata and audio streams. Possible range: 0 a 128</p> <p>The default value are:</p> <ul style="list-style-type: none"> • 97 for SMPTE 2110-20 (Video) • 100 for SMPTE 2110-40 (Metadata) • 96 for SMPTE 2110-30 (audio)
DSCP	<p>Sets the quality of service priority on the network for the outgoing video, metadata, and audio streams. The range is 0 to 63.</p> <p>The default values are:</p> <ul style="list-style-type: none"> • 0 for SMPTE 2110-20 (Video) • 0 for SMPTE 2110-40 (Metadata) • 34 for SMPTE 2110-30 (audio)

10.6 Video Panel

The Video panel has two tabs (**UDC1** and **UDC2**); one for each of XIP-3901-UDC-IP's independent processing channels. The configuration of the **UDC2** tab is the same as the **UDC1** tab. Only the configuration of the **UDC1** tab is shown below.

10.6.1 Timing Tab

For each upconverter / downconverter, you can adjust the timing relative to the reference. Use the slider or type a value into the data box on the right of the slider. Metadata and audio streams will match the video delay set below.

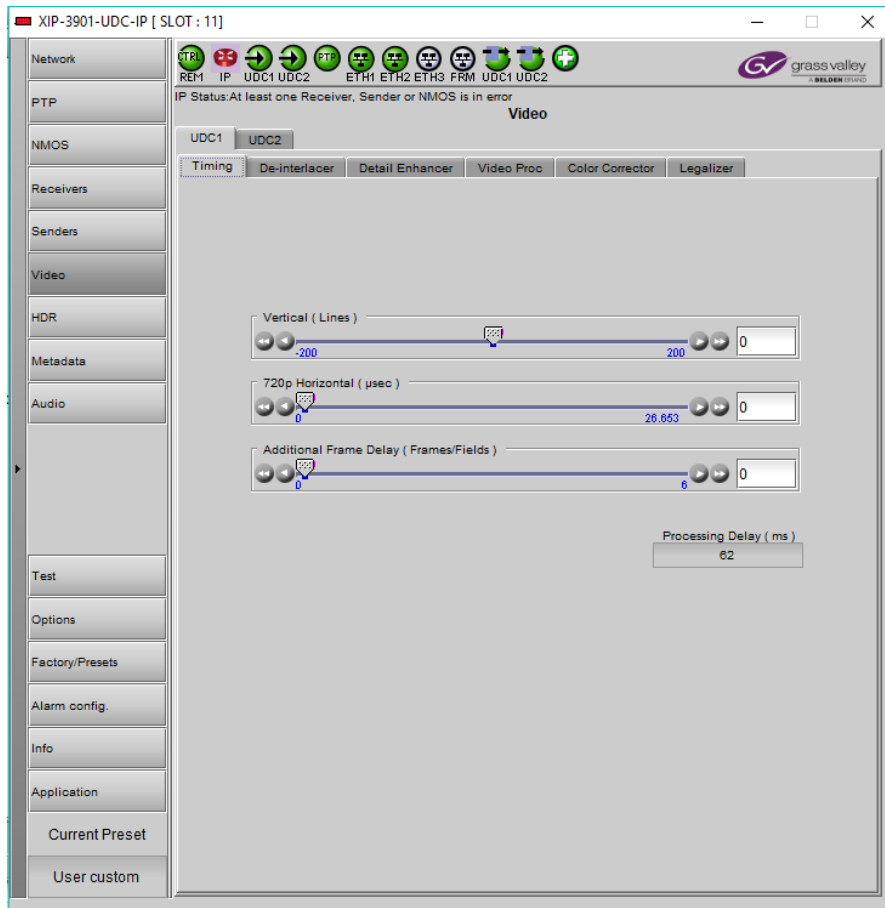

Figure 62 – Video Timing Tab

The following adjustment sliders are available:

Adjustment	Range (50 Hz)	Range (59 Hz)	Description
Vertical (Lines)	-200 to +200	-200 to +200	Vertical setting applies to all output formats.
1920x1080p (A) Horizontal (µsec)	0 to 17.771 µsec	0 to 14.825 µsec	Horizontal settings are specific to individual output formats.
1920x1080i Horizontal (µsec)	0 to 35.542 µsec	0 to 29.646 µsec	
1280x720p Horizontal (µsec)	0 to 26.653 µsec	0 to 22.231 µsec	

Adjustment	Range (50 Hz)	Range (59 Hz)	Description
Additional Frame Delay	0 to 6	0 to 6	Manage frames for progressive outputs and fields for interlaced format. With interlaced formats, the slider jumps by steps of 2 fields.

This section also displays the Processing Delay in microseconds so you can manage the processing delay on your system.

The XIP-3901 has an integrated frame sync that supports synchronous and asynchronous SDI input signals. The input signals will be synchronized and realigned to the URS.

The frame sync behaves like a frame buffer. It also supports frame skips/repeats in the case of an asynchronous SDI input. When an input error occurs, it freezes to the last valid field/frame.

1. On a skip/repeat frame, PCM audio will take up to 15 seconds to track. For non-PCM audio, it will instantly catch-up.
2. On skip/repeat frame, metadata is skipped or duplicated.
3. On freeze, audio is muted and metadata is blanked

The following table shows the amount of time for a vertical line.

Input Video Format Setting	Output Video Format	Line length	Description		
1280x720p 59Hz	Auto (Follow Input)	22.244 µsec	Frame rate follows Input - video format (detected video format)		
1280x720p 50Hz		26.667 µsec			
1920x1080p 23.98Hz		37.074 µsec			
1920x1080p 29.97Hz		29.659 µsec			
1920x1080i 59Hz		29.659 µsec			
1920x1080i 50Hz		35.556 µsec			
1920x1080p 59Hz		14.830 µsec			
1920x1080p 50Hz		17.778 µsec			
3840x2160p 23.98Hz		37.074 µsec			
3840x2160p 29.97Hz		29.659 µsec			
3840x2160p 59Hz		14.830 µsec			
3840x2160p 50Hz		17.778 µsec			
<i>Ignored</i>		1280x720p 59Hz		22.244 µsec	Frame rate follows Output - video format
		1280x720p 50Hz		26.667 µsec	
	1920x1080p 23.98Hz	37.074 µsec			
	1920x1080p 29.97Hz	29.659 µsec			
	1920x1080i 59Hz	29.659 µsec			
	1920x1080i 50Hz	35.556 µsec			
	1920x1080p 59Hz	14.830 µsec			
	1920x1080p 50Hz	17.778 µsec			
	3840x2160p 23.98Hz	37.074 µsec			
	3840x2160p 29.97Hz	29.659 µsec			
	3840x2160p 59Hz	14.830 µsec			
3840x2160p 50Hz	17.778 µsec				

10.6.2 De-interlacer Tab

Each processing channel has its own de-interlacer for use with interlaced sources. The Film Mode and Video Over Film settings can either be set to On or Off. By default, both are set to On for optimal performance.

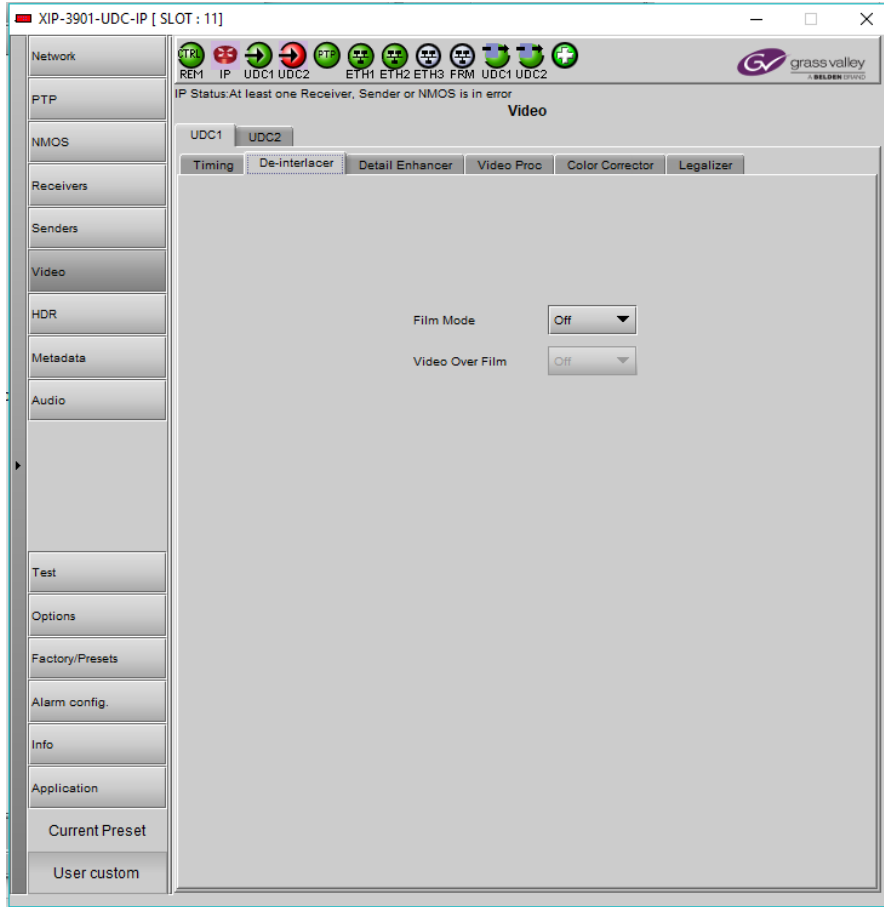

Figure 63 – De-interlacer Timing Tab

Property	Description
Film Mode	Some interlaced video sources are film-based, originating from 24p film images. When Film Mode is on, the de-interlacer will monitor the input for this type of source. When detected, it will merge the fields to recreate the original 24p image, thereby avoiding de-interlacer artifacts prior to scaling and upconversion. Film detection is provided for 3:2, 2:2 (59 Hz and 50 Hz sources) and 5:5 sequences.
Video Over Film	Video Over Film is available only when Film Mode is enabled. When Video Over Film is on, the de-interlacer will detect video over film content and bypass field-merging on certain video regions such as scrolling video characters over an entire film frame, thereby preventing any unwanted combing effects.

10.6.3 Detail Enhancer Tab

The Detail Enhancer allows you to apply a level of enhancement to the signal to regain lost detail or to simply create a sharper image. Horizontal and Vertical slide controllers allow you to adjust the magnitude of the enhancer to be set both horizontal and vertical directions. These controls only work after down-scaling of video resolution. For example, 2160p to 1080p or 1080i for instance.

The **Mode** Control allows the user to select the particular luminance frequency band to be enhanced – Medium Frequency or High frequency.

Horizontal and Vertical Enhancer Controls are usually used with restraint by only making minor adjustments. The optimum settings of the Horizontal and Vertical Detail Enhancer are dependent on the source. The amount of aliasing on the output will be dependent upon the higher frequencies present in the source content and a balance would need to be established between aliasing artifacts, picture sharpness, and the amount of detail. For example, if the enhancers are configured to allow more high frequency content through, this will have the benefit of making the output pictures appear sharper, but the effect can come at the cost of introducing aliasing to the image.



Figure 64 – Detail Enhancer Tab

Property	Description
Enable	Set to enable vertical and horizontal enhancement adjustment. The below settings can be adjusted, but they will only be applied when Enable is set.

Property	Description
Mode	Select the particular frequency band to be enhanced: High: Boost the high frequency content of the input signal. Medium: Boost the medium frequency content of the input signal.
Horizontal Detail Enhancer	Set the amount of horizontal detail enhancement to be applied to the video signal. TIP: Use restraint and only make minor adjustments.
Vertical Detail Enhancer	Set the amount of vertical detail enhancement to be applied to the video signal. The Vertical Enhancer adjustment ranges from a <i>soft</i> range (negative values) to a max intensity <i>sharper</i> (positive values): It is not usual practice to want to make pictures <i>softer</i> than the source. However, in some circumstances this is a requirement. For example, when an ultra-sharp high definition content is to be down-converted, the high frequency content of the source may cause aliasing in the downconverted output. By <i>softening</i> the processed pictures, the aliasing can be reduced or eliminated. TIP: Use restraint and only make minor adjustments.
Reset Defaults	Click to revert all controls to their default settings.

10.6.4 Video Proc Tab

The Video Proc controls allow you to apply a correction to the individual signal components of the Y'CrCb color space. This follows the input colorimetry of the one selected in the HDR panel.



Figure 65 – Video Proc Tab

Property	Description
Enable	Set to enable Y'CrCb color space adjustment.
Master Gain	Set the overall gain (Y and Cb/Cr). Y and C gain may be independently adjusted with the controls shown below. Note: The total range of both Master + Y and Master + C controls is limited to +6 dB to -6 dB
Luma (Y) Gain	Set the Y (Luminance) gain.
Chroma (Cb/Cr) Gain	Set the Cb/Cr (Color difference) gain.
Black Level	Set the Black level.
Hue	Set the Hue of the signal.
Reset Defaults	Click to revert all controls to their default settings.

10.6.5 Color Corrector Tab

The Color Corrector controls allow you to apply correction to the individual primary RGB channels.



Figure 66 – Color Corrector Tab

Property	Description
Enable	Set to enable RGB color space adjustment.
Gang	Set to adjust all three RGB channels together at the same time. Deselect to adjust the RGB channels individually.
Green Gain	Set the Green Channel Gain value.
Blue Gain	Set the Blue Channel Gain value.
Red Offset (Lift)	Set the Red Channel Offset value.
Green Offset (Lift)	Set the Green Channel Offset value.
Blue Offset (Lift)	Set the Blue Channel Offset value.
Red Gamma	Set the Red Gamma.
Green Gamma	Set the Green Gamma.
Blue Gamma	Set the Blue Gamma.
Reset Defaults	This function allows for all controls to revert to their preset values.

10.6.6 Legalizer Tab

The Legalizer ensures that the output video stays within the legal RGB gamut limit, making it suitable for the broadcast signal chain.

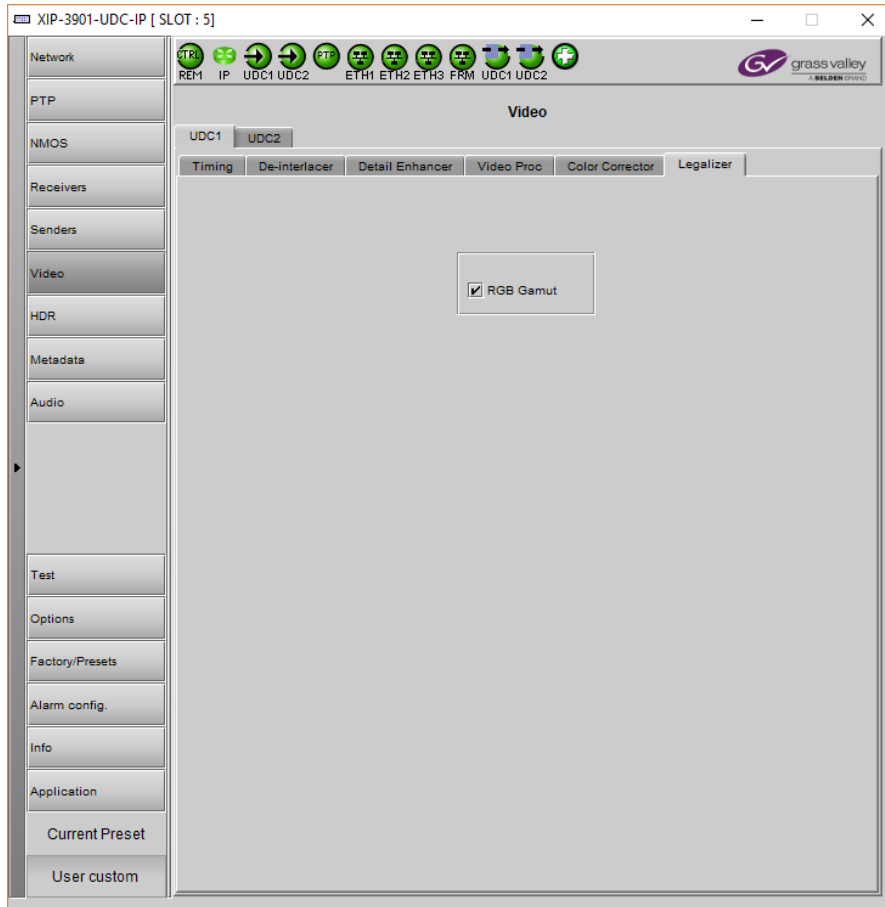

Figure 67 – Legalizer Tab

Property	Description
RGB Gamut	Set to clip all illegal Y’CbCr colors in the RGB space to a legal value.

10.7 HDR Panel

The HDR panel has two tabs (**UDC1** and **UDC2**); one for each of XIP-3901-UDC-IP's independent processing channels. The configuration of the **UDC2** tab is the same as the **UDC1** tab. Only the configuration of the **UDC1** tab is shown below.

10.7.1 UDC1/2 Tab

Grass Valley offers its own HDR processing. However, you can decide to use BBC LUTs or to load your own Custom LUTs. Furthermore, we can correct incoming VPID without applying any HDR conversion. Use the radio button to select the desired processing. Grass Valley HDR processing is selected by default.

Grass Valley BT.709 to BT2020 and BT.2020 to BT.709 are always available. Other video processing settings can be enabled for each channel by activating the **XIP-3901-UDC-HDR** option. See 10.11 _Options Panel on page 118 for details about how to activate card options.

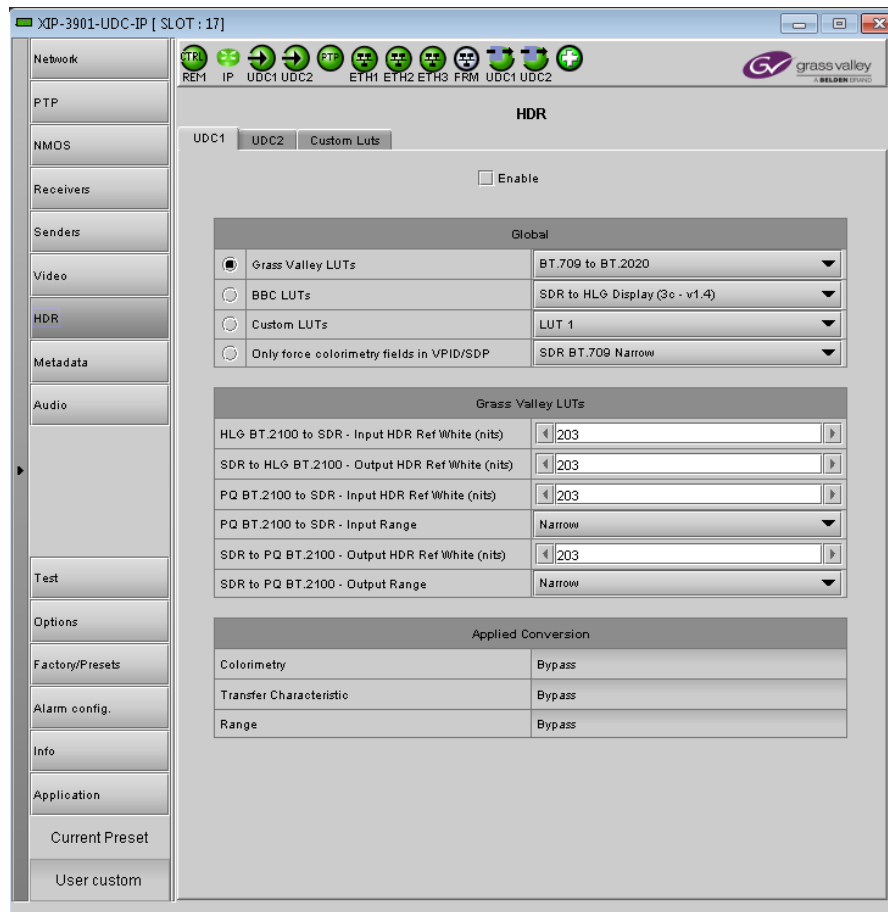

Figure 68 – HDR UDC1 / UDC2 Tab

Property	Description
Enable	Set to enable color space conversion and dynamic range conversion. When disabled, incoming color space and dynamic range are bypassed without processing. The Applied Conversion statuses will indicate “Bypass”. You can change the HDR processing setting values even if processing is disabled, but processing will not be performed. Processing is disabled by default.
Grass Valley LUTs	Set the LUT to use for HDR processing. The following HDR processing setting are available as part of the Grass Valley LUTs : <ul style="list-style-type: none"> • BT.709 to BT.2020 • BT.2020 to BT.709 • SDR to HLG BT.2100 • SDR to PQ BT.2100 • HLG BT.2100 to SDR • PQ BT.2100 to SDR • PQ BT.2100 to HLG BT.2100 • HLG BT.2100 to PQ BT.2100 • S-Log3 S-Gamut3 to BT.709 800% • S-Log3 S-Gamut3 to HLG BT.2100 • S-Log3 S-Gamut3 to PQ BT.2100
BBC LUTs	Set the LUT to use for HDR processing. The following HDR processing setting are available as part of the BBC LUTs : <ul style="list-style-type: none"> • SDR to HLG Scene (4-1a - v1.4) • SDR to HLG Scene Strict (4-2a - v1.4) • SDR to HLG Scene Upmap (6-1a - v1.4) • SDR to HLG Scene Upmap Strict (6-2a - v1.4) • SDR to HLG Display (3c - v1.4) • SDR to HLG Display Upmap (5c - v1.4) • HLG to SDR Scene (12-1c - v1.4) • HLG to SDR Scene Strict (12-2c - v1.4) • HLG to SDR Display (8c - v1.4) • HLG to SDR Display Harsh (9c - v1.4) • PQ 1000 Nits Full Range to HLG (1c - v1.4) • PQ 1000 Nits Narrow Range to HLG (1e - v1.4) • PQ 4000 Nits Full Range to HLG (2c - v1.4) • PQ 4000 Nits Narrow Range to HLG (2e - v1.4) • HLG to PQ 1000 Nits Narrow range (7c - v1.4) • SLog3 100% Scene to HLG (10a - v1.4) • SLog3 200% Scene to HLG (11a - v1.4) • Unity
Custom LUTs	Set the LUT to use for HDR processing. You can pre-load up to 8 custom HDR conversions on the card. These are configured in the Custom Luts tab.
Only force colorimetry fields in VPID/SDP	Set to force the use of an SDP File. Sometimes, incoming HDR processing is not flagged properly by its SDP File. You can use this option to correct the outgoing SDP File: <ul style="list-style-type: none"> • SDR BT.709 Narrow • HLG BT.2020 Narrow • PQ BT.2020 Narrow • PQ BT.2020 Full <p>Note: This application does not use VPID.</p>
HLG BT.2100 to SDR – Input HDR Ref White (nits)	Set the <i>reference white</i> luminance level in nits that will become 100% white in the SDR output. The value range must be between 100 and 1000 nits. The default value is 203 nits. This parameter is only applied when the Grass Valley HLG BT.2100 to SDR LUT is selected.

Property	Description
SDR to HLG BT.2100 – Output HDR Ref White (nits)	Set the <i>reference white</i> luminance level in nits for the HDR output that represents 100% white in the SDR input. The value range must be between 100 and 1000 nits. The default value is 203 nits. This parameter is only applied when the Grass Valley SDR to HLG BT.2100 LUT is selected.
PQ BT.2100 to SDR – Input HDR Ref White (nits)	Set the <i>reference white</i> luminance level in nits that will become 100% white in the SDR output. The value range must be between 100 and 1000 nits. The default value is 203 nits. This parameter is only applied when the Grass Valley PQ BT.2100 to SDR is selected.
PQ BT.2100 to SDR – Input Range	Set the input range to Full or Narrow : <ul style="list-style-type: none"> • Full: 0 to 1023 image mapping range according to SMPTE RP. 2077. • Narrow: The standard 64 to 940 image mapping broadcast range. This parameter is only applied when the Grass Valley PQ BT.2100 to SDR LUT is selected.
SDR to PQ BT.2100 – Output HDR Ref White (nits)	Set the <i>reference white</i> luminance level in nits for the HDR output that represents 100% white in the SDR input. The value range must be between 100 and 1000 nits. The default value is 203 nits. This parameter is only applied when the Grass Valley SDR to PQ BT.2100 LUT is selected.
SDR to PQ BT.2100 – Output Range	Set the output range to Full or Narrow : <ul style="list-style-type: none"> • Full: 0 to 1023 image mapping range according to SMPTE RP. 2077. • Narrow: The standard 64 to 940 image mapping broadcast range. This parameter is only applied when the Grass Valley SDR to PQ BT.2100 LUT is selected.
Colorimetry	Shows the applied conversion according to the above settings.
Transfer Characteristic	
Range	

10.7.2 Custom Luts Tab

This tab allows you to load up to 8 custom LUTs (LUT1 to LUT8) that can be selected for use in the UDC1/2 tabs. The XIP only supports files that conform to the Adobe Cube file v1.0 format. Custom Luts are shared among all XIP applications. This feature requires the XIP-3901-UDC-HDR option. See 10.11 - Options Panel on page 118 for details about how to activate card options.

You can Load up to 8 LUTs. For each custom LUT you load, you need to specify input/output colorimetry, input/output range and output transfer characteristics.

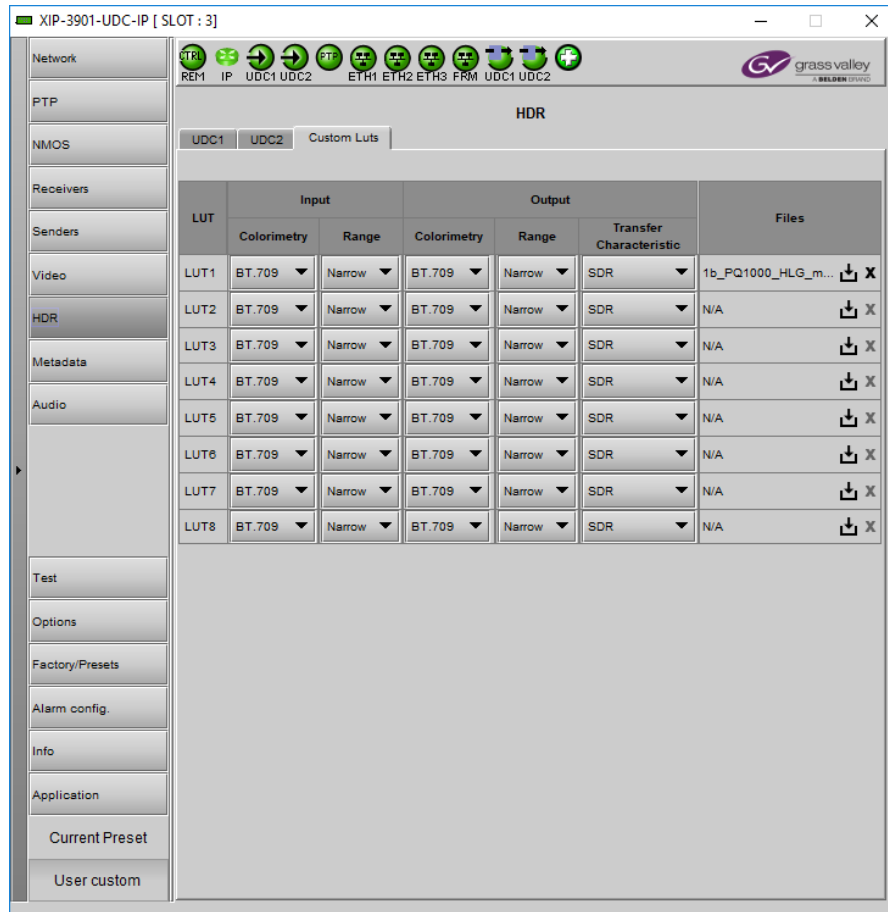

Figure 69–Custom Luts Tab

Property	Custom LUTs Parameters	Available Values / Description
Input	Colorimetry	BT.709, BT.2020
	Input Range	Narrow, Full
Output	Colorimetry	BT.709, BT.2020
	Output Range	Narrow, Full
	Transfer Characteristic	SDR, HLG, PQ, Unspecified
Files	–	Click to upload or replace a LUT file. Click to remove the currently loaded LUT file. The name of the currently loaded LUT file will be partially displayed. Mouse-over the field to display the full name. The background will change to RED if the uploaded file is invalid.

10.8 Metadata Panel

The Metadata panel has two tabs (**UDC1** and **UDC2**); one for each of XIP-3901-UDC-IP's independent processing channels. The configuration of the **UDC2** tab is the same as the **UDC1** tab. Only the configuration of the **UDC1** tab is shown below.

The XIP-3901-UDC-IP manages the transfer of metadata between its input and output, but does not process the metadata information regarding the video conversion. In the Metadata Panel, you can selectively pass or block any one of eight specific ANC data types by specifying the DIDs and SDIDs to be passed from input to output and those that are to be blocked.

In the case of **Time Code** option, when set to the **Process** mode, this activates the controls under the **Timecode** tab.

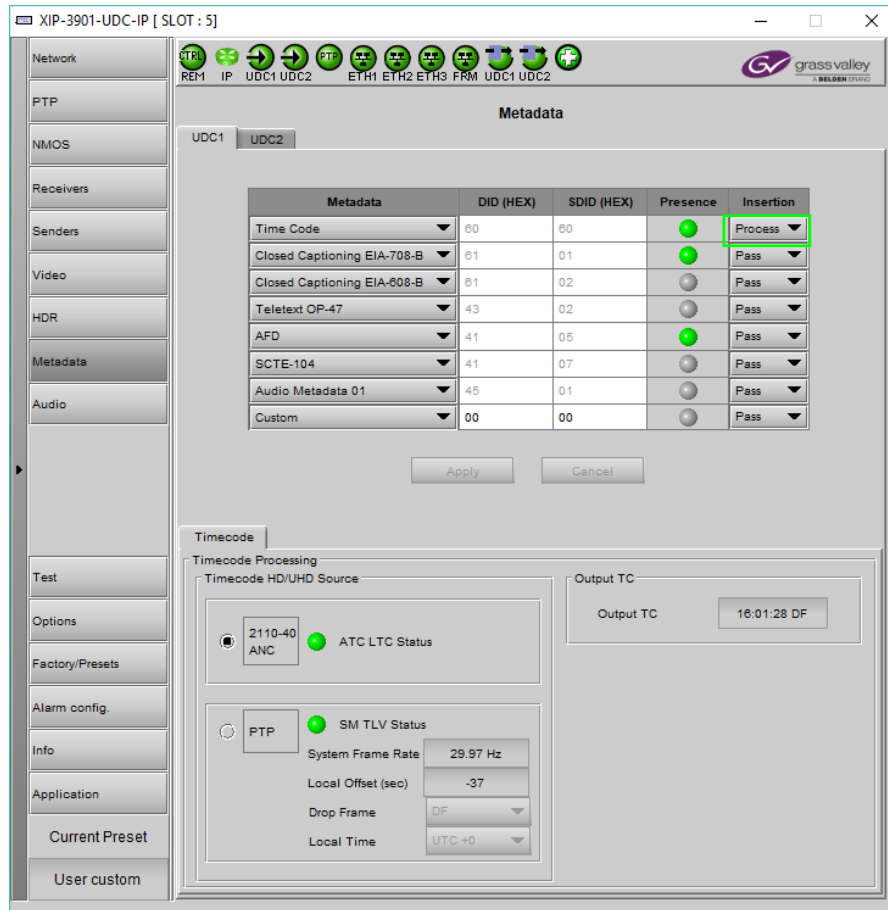

Figure 70 – Metadata panel

Property	Description
Metadata DID (HEX) SDID (HEX)	Use any of the eight pulldowns to select the metadata you want to pass or block. You can select any predefined Metadata and the card will manage DID and SDID for you: <ul style="list-style-type: none"> • Time Code: DID/SDID = 60h/60h. When set to Process mode, this activates the controls under the Timecode tab at the bottom of the panel. • Closed Captioning EIA-708-B: DID/SDID = 61h/01h • Closed Captioning EIA-608-B: DID/SDID = 61h/02h • Teletext OP-47: DID/SDID = 43h/02h • AFD: DID/SDID = 41h/05h • SCTE 104: DID/SDID = 41h/07h • Audio Metadata 01: DID/SDID = 45h/01h • Audio Metadata 02: DID/SDID = 45h/02h • Audio Metadata 03: DID/SDID = 45h/03h • Audio Metadata 04: DID/SDID = 45h/04h • Audio Metadata 05: DID/SDID = 45h/05h • Audio Metadata 06: DID/SDID = 45h/06h • Audio Metadata 07: DID/SDID = 45h/07h • Audio Metadata 08: DID/SDID = 45h/08h • Audio Metadata 09: DID/SDID = 45h/09h • Custom: you can specify a custom metadata by specifying DID and SDID. You cannot set the same metadata twice based on DID and SDID.
Presence	Shows if the selected metadata type has been detected. The status indicator shows the current metadata status: Green: the selected metadata is present. Grey: the selected metadata is not present.
Insertion	Set whether the detected ancillary packet is to be inserted into the card's output: Pass: allow the detected ancillary packet is to be passed through the card. Block: drop the detected ancillary packet from being passed through the card.
Apply Cancel	When active, this applies or rejects your current changes made in this tab.
Timecode HD/UHD Source	Select the source containing Timecode information for further processing. 2110-40 ANC: Extract Timecode from the 2110-40 metadata stream in the format of ATC LTC timecode. The presence status of ATC LTC timecode is reflected through the color of the associated LED: Green: ATC LTC timecode packet present Red: ATC LTC timecode packet not present PTP: Extract Timecode from the PTP packet and extract the following additional information from the TLV messages: <ol style="list-style-type: none"> 1. System Frame Rate associated with the timecode information. 2. Style of Timecode DF (drop frame) or NDF (non-drop frame). 3. Local Offset and the derive Local Time form Local Offset. The presence status of all three TLV's is reflected through the color of the associated LED: Green: SM TLV timecode packet present Red: SM TLV timecode packet not present
Drop Frame	For the PTP option, when there is no TLV Status (status LED is red), set the timecode type: DF: Drop frame. NDF: Non-drop frame.
Local Time	For the PTP option, when there is no TLV Status (status LED is red), set your UTC time zone offset for your geographic location.

Property	Description
Output TC	Shows the output timecode in Hours:Min:Sec and the timecode type: DF (drop frame) or NDF (non-drop frame). Only active when Time Code under Metadata is set to Process .

10.9 Audio Panel

The Audio panel has two tabs (**UDC1** and **UDC2**); one for each of XIP-3901-UDC-IP's independent processing channels. The configuration of the **UDC2** tab is the same as the **UDC1** tab. Only the configuration of the **UDC1** tab is shown below.

The relative processing order of audio panel components is shown below.

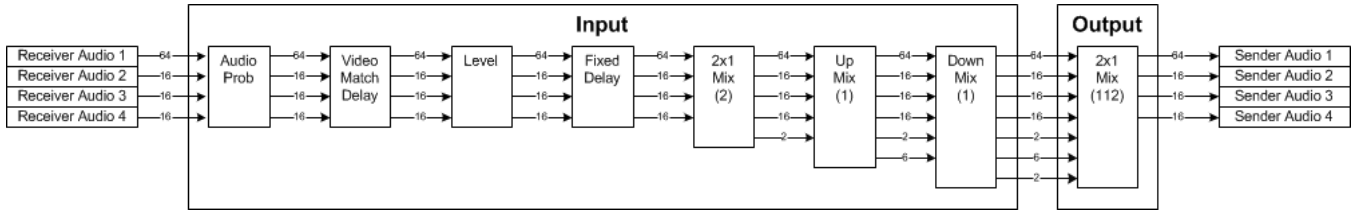

Figure 71 – Overview of XIP-3901-UDC-IP Audio Processing

10.9.1 Inputs Tab

This tab allows you to set individual audio stream input parameters such as the level, delay, phase invert, and to mute an input. This tab also supports audio probing: embedded audio group detection, audio presence and audio type for all incoming audio channels. There are also tabs for incoming audio: **Audio 1**, **Audio 2**, **Audio 3**, and **Audio 4**.

Tab	Audio Channels Supported
Audio 1	CH1 to CH64
Audio 2	CH1 to CH16
Audio 3	CH1 to CH16
Audio 4	CH1 to CH16

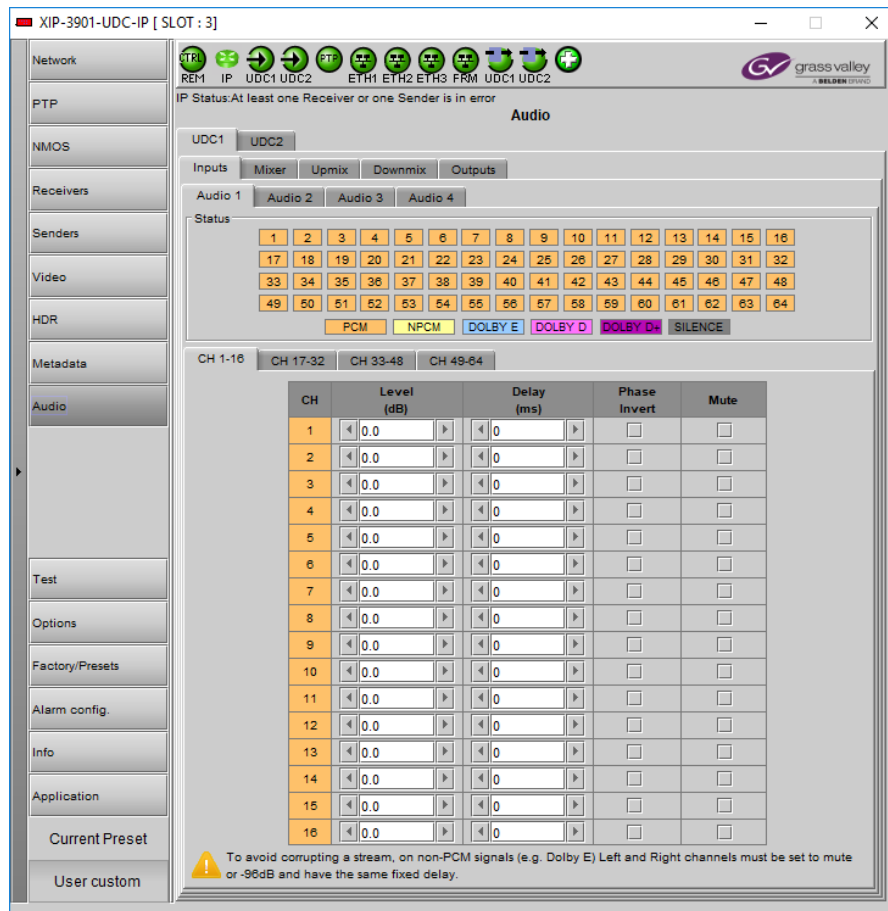

Figure 72 – Audio Inputs Tab

Property	Description
Status	Shows audio group 1 to 4 detection for embedded audio: Green: Audio Group present Grey: Audio Group not present PCM Signal is present and detected audio type is PCM NPCM Signal is present and detected audio type is NPCM Dolby E Signal is present and detected audio type is Dolby E Dolby D Signal is present and detected audio type is Dolby Digital (Dolby D) Dolby D+ Signal is present and detected audio type is Dolby Digital plus (Dolby D+) Silence Signal not present because a silence of -60 dBFS or less was detected for over 3 seconds
Level	Sets input gain level for an audio channel. At -96dB, the signal is completely muted. You can mouse over the level setting to see the available range. The range is always -96 to 12dB and can be set in 0.5 dB steps. By default no gain level is applied (0 dB). This setting has no effect on a non-PCM audio channel except if this level is set to -96dB (signal is muted).

Property	Description
Delay	<p>You can delay or advance audio from the nominal value, in order to deal with problems such as lip-sync errors and audio phase alignment in the incoming feed.</p> <p>You can delay of up to 500 ms in steps of 1ms. To advance audio, you need first to delay the video. Video can be delayed up to 6 fields/frames. As an example, if you delay 1920x1080p59Hz output by 2 frames, you can advance the audio by up to 66ms.</p> <p>At any time you can mouse over this field to see the current available fixed delay range. By default no fixed delay is applied (0ms).</p> <p>A fixed delay can still be used with non-PCM signals, but you must use the same delay values for the left and right channels to preserve signals such as Dolby E.</p>
Phase Invert	<p>Set to phase invert an audio channel. This setting has no effect on a non-PCM audio channel. By default, phase invert is disabled.</p>
Mute	<p>Set to mute an audio channel. By default, mute is disabled.</p>

10.9.2 Mixer Tab

This tab provides two 2x1 mixers. Each mixer will adds two new audio mix output channels to the audio processing path: **Mixer - CH1** and **Mixer - CH2**. These channels are available as inputs to other audio processing tabs. See also Figure 71.

All incoming audio channels are available for mixing:

- **Audio 1 - CH1 to CH64:** Audio coming from the 1st audio receiver.
- **Audio 2 - CH1 to CH16:** Audio coming from the 2nd audio receiver.
- **Audio 3 - CH1 to CH16:** Audio coming from the 3rd audio receiver.
- **Audio 4 - CH1 to CH16:** Audio coming from the 4th audio receiver.

This tab allows you to mix two pairs of PCM audio channels. This feature requires the **XIP-3901-UDC-AUD** option. See 10.11 - Options Panel on page 118_for details about how to activate card options.



Figure 73 – Audio Mixer Tab

Property	Description
Inputs: Mixer Source A and Source B	Select audio sources.
Level	Sets input gain level for an audio channel. At -96dB, the signal is completely muted. You can mouse over the level setting to see the available range. The range is always -96 to 12dB and can be set in 0.5 dB steps. By default no gain level is applied (0 dB). By default, Source A is passed-through and Source B is muted. If one audio mix input channel is non-PCM, Source A will pass-through except if its level setting is -96dB (signal is muted).
Mute	Set to mute a mixed audio channel output. By default, mixed signals are not muted.

10.9.3 Upmix Tab

This tab allows you to upmix stereo audio channels into simulated 5.1 surround sound. Upmix will generate 6 new audio channels to the audio processing path: **UPMIX - CH1** to **CH6** that can be used as inputs to other audio processing tabs. See also Figure 71.

All incoming audio channels and new mixed audio channels are available:

- **Audio 1 - CH1 to CH64**: Audio coming from the 1st audio receiver.
- **Audio 2 - CH1 to CH16**: Audio coming from the 2nd audio receiver.
- **Audio 3 - CH1 to CH16**: Audio coming from the 3rd audio receiver.
- **Audio 4 - CH1 to CH16**: Audio coming from the 4th audio receiver.
- **Mixer - CH1 to CH2**: Mixed audio channels.

This feature requires the **XIP-3901-UDC-AUD** option. See 10.11 - Options Panel on page 118 for details about how to activate card options.

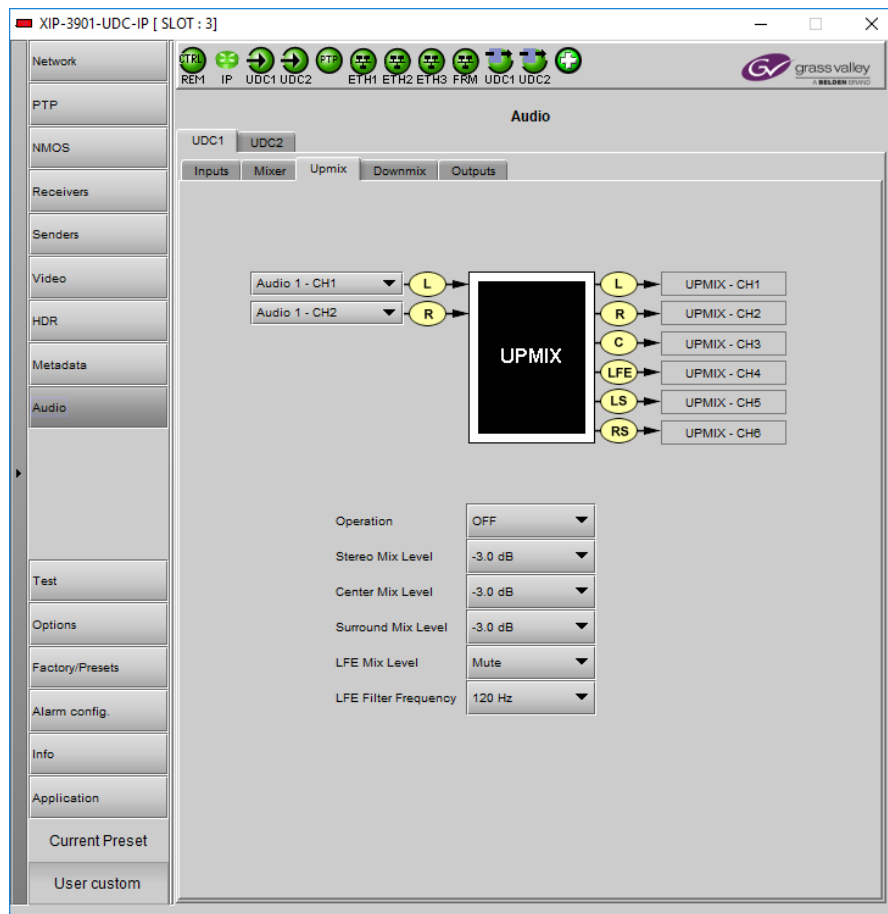

Figure 74 – Audio Upmix Tab

Property	Description
Inputs: Left (L), Right (R) Inputs	Select audio sources. If one or more upmix input channel is non-PCM, all UPMIX output channels will be muted.
Operation	OFF : Disable upmix processing. UPMIX – CH1 to UPMIX – CH6 outputs are muted. ON : Enable upmix processing. By default, upmix is disabled.

Property	Description
Stereo Mix Level	Set the gain level for the left and right upmix channels. Possible values are: +3.0 dB, +1.5 dB, 0.0 dB, -1.5 dB, -3.0 dB, -4.5 dB, -6.0 dB and Mute. The default level is -3.0 dB.
Center Mix Level	Set the gain level for the center upmix channel. Possible values are: +3.0 dB, +1.5 dB, 0.0 dB, -1.5 dB, -3.0 dB, -4.5 dB, -6.0 dB, and Mute. The default level is -3.0 dB.
Surround Mix Level	Set the gain level for the left surround and right surround upmix channels. Possible values are: +3.0 dB, +1.5 dB, 0.0 dB, -1.5 dB, -3.0 dB, -4.5 dB, -6.0 dB, and Mute. The default level is -3.0 dB.
LFE Mix Level	Set the gain level for the low-frequency effects (LFE) upmix channel. Possible values are: +10.0 dB, + 9.0 dB, +7.5 dB, +6.0 dB, +4.5 dB, +3.0 dB, +1.5 dB, 0.0 dB, -1.5 dB, -3.0 dB, -4.5 dB, -6.0 dB, and Mute. The default level is Muted.
LFE Filter Frequency	Set the crossover frequency for bass at which: <ul style="list-style-type: none"> • Bass program content is filtered to the low-frequency effects (LFE) upmix channel. • The remaining upper frequency band is filtered to the other upmix channels (left, right, center, left surround, and right surround). • The default frequency is 120Hz.

10.9.4 Downmix Tab

This tab allows you to downmix a 5.1 surround sound signal to a LoRo or LtRt stereo channel pair. Downmix will generate 2 new audio channels to the audio processing path: **DMIX - CH1** to **CH2** that can be used as inputs to other audio processing tabs. See also Figure 71.

All incoming audio channels, new mixed and upmixed audio channels are available:

- **Audio 1 - CH1 to CH64:** Audio coming from the 1st audio receiver.
- **Audio 2 - CH1 to CH16:** Audio coming from the 2nd audio receiver.
- **Audio 3 - CH1 to CH16:** Audio coming from the 3rd audio receiver.
- **Audio 4 - CH1 to CH16:** Audio coming from the 4th audio receiver.
- **Mixer - CH1 to CH2:** Mixed audio channels.
- **Upmix - CH1 to CH6:** Upmixed audio channels.

This feature requires the **XIP-3901-UDC-AUD** option. See 10.11 - Options Panel on page 118 for details about how to activate card options.

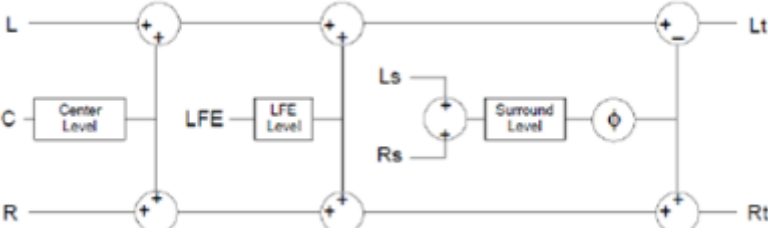
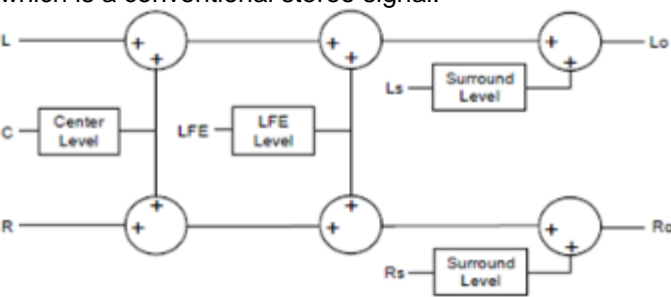

Figure 75 – Audio Downmix Tab

Property	Description
Inputs: Left (L), Right (R), Center (C), LFE, Left surround (LS) and Right surround (LR)	Select audio sources. If one or more downmix input channel is non-PCM, all DMIX output channels will be muted.
Operation	OFF: Disable downmix processing. DMIX – CH1 and DMIX – CH2 outputs are muted. ON: Enable downmix processing.
Mode	<p>LtRt: Enables the downmix of 5.1 channels into an LtRt (Left total Right total) matrix surround encoded stereo pair.</p>  <p>LoRo: Enables the downmix of 5.1 channels into a LoRo (Left only Right only) stereo pair, which is a conventional stereo signal.</p> 
Dialnorm	Set the dialog normalization level. Possible values are: -31 dBFS to -1 dBFS, and OFF. Default value is OFF.
Center Mix Level	Set the gain level for the center downmix channel. Possible values are: +3.0 dB, +1.5 dB, 0.0 dB, -1.5 dB, -3.0 dB, -4.5 dB, -6.0 dB, and Mute. The default level is -3.0 dB.
Surround Mix Level	Set the gain level for the left surround and right surround downmix channels. Possible values are: +3.0 dB, +1.5 dB, 0.0 dB, -1.5 dB, -3.0 dB, -4.5 dB, -6.0 dB, and Mute. The default level is -3.0 dB.
LFE Mix Level	Set the gain level for the low-frequency effects (LFE) downmix channel. Possible values are: +10.0 dB, +9.0 dB, +7.5 dB, +6.0 dB, +4.5 dB, +3.0 dB, +1.5 dB, 0.0 dB, -1.5 dB, -3.0 dB, -4.5 dB, -6.0 dB, and Mute. The default level is mute.
Level Normalization	OFF: Disable output level normalization. ON: Enable output level normalization: the output level is normalized based on the applied mix levels to provide a uniform output over the range of mix levels available. Clipping will never occur, even with full scale input channels and mix levels. Default value is ON.

10.9.5 Outputs Tab

This tab allows you to shuffle and mix audio output streams down to a maximum of 128 output channels. There is a tab for each audio output: **Audio 1**, **Audio 2**, **Audio 3**, and **Audio 4**.

All incoming audio channels and all new generated audio channels are available:

- **Audio 1 - CH1 to CH64:** Audio coming from the 1st audio receiver
- **Audio 2 - CH1 to CH16:** Audio coming from the 2nd audio receiver
- **Audio 3 - CH1 to CH16:** Audio coming from the 3rd audio receiver
- **Audio 4 - CH1 to CH16:** Audio coming from the 4th audio receiver
- **Mixer - CH1 to CH2:** Mixed audio channels
- **Upmix - CH1 to CH6:** Upmixed audio channels
- **Dmix - CH1 to CH2:** Downmixed audio channels

The output processing (shuffler and mixer) will set the following outgoing audio channels:

- **Audio 1 CH1 to CH64:** 1st Audio sender
- **Audio 2 CH1 to CH16:** 2nd Audio sender
- **Audio 3 CH1 to CH16:** 3rd audio sender
- **Audio 4 CH1 to CH16:** 4th audio sender

This feature requires the **XIP-3901-UDC-AUD** option. See 10.11 Options Panel on page 118 for details about how to activate card options.



Figure 76 – Audio Downmix Tab

Property	Description
Inputs: Mixer Source A and Source B	Select audio sources.
Level	Sets input gain level for an audio channel. At -96dB, the signal is completely muted. You can mouse over the level setting to see the available range. The range is always -96 to 12dB and can be set in 0.5 dB steps. By default no gain level is applied (0 dB). By default, Source A is passed-through and Source B is muted. If one audio mix input channel is non-PCM, Source A will pass-through except if its level setting is -96dB (signal is muted).
Mute	Set to mute a mixed audio channel output. By default, mixed signals are not muted.

10.10 Test Panel

You may activate the Color Bars & Tone test signal for the two channels independently by enabling the appropriate checkboxes. When HDR the **XIP-3901-UDC-HDR** option is activated, HDR test patterns are available. See 10.11 - Options Panel on page 118 for details about how to activate card options.





Figure 77 – Test Panel

Property	Description
Color Bars & Tone	<p>Enables test signals at the card's output:</p> <ul style="list-style-type: none"> Video: Generate a video test pattern. On HD Video outputs, this will generate a 75% color bar with 75% white. On 1080p & 2160p Video outputs, test pattern will follow the format setting. Audio: Generate a 1 KHz sine wave at -18dBFS on all audio channel outputs: <ul style="list-style-type: none"> Continuous tone on right channel; pulsed tone on left channel of every pair (250 ms pulse every 3 seconds). Audio tones enabled on all 16 embedded audio channels and on all streamed audio channels. Metadata: blank
Format	<p>Set video test pattern format for 1080p & 2160p Video outputs:</p> <ul style="list-style-type: none"> SDR BT.709 (75%): 75% Color bar with 75% white HLG BT.2110-0: Test pattern HLG narrow range as per ITU-R BT.2111-0 PQ Narrow BT.2111-0: Test pattern PQ narrow range as per ITU-R BT.2111-0 PQ Full BT 2111-0: Test pattern PQ full range as per ITU-R BT.2110-0

Status

When Test mode is activated on a channel, the status icon display for that channel will show the Color Bars & Tone icon.

Test Pattern	Operating Mode	Icon
Enabled	Color Bars & Tone	
Disabled	Process	

10.11 Options Panel

The following options are available for the XIP-3901-UDC-IP:

- XIP-3901-UDC-HDR:** Enables the card's HDR conversion function. When this option is activated, all HDR conversion settings are available. When it is not activated, only the BT.709 to BT.2020 and BT.2020 to BT.709 settings are available.
See 10.7.1 -UDC1/2 Tab on page 101 to see all settings available with this option.
- XIP-3901-UDC-AUD:** Enables the card's audio probing and processing for all XIP applications. See 2.2.3 - Optional XIP-3901-UDC-IP Application Audio processing, Down/Up Mix, Shuffling on page 15.

To activate an option, you must:

- Obtain a license key for the option from Grass Valley.
- Open the Options panel and select the appropriate tab.
- Type the license key in the Enter key box.
- Click **Enable option** to enable the option's features.

Once the option is activated, the status box beneath the Enter key area will show the status as active, with a green background.

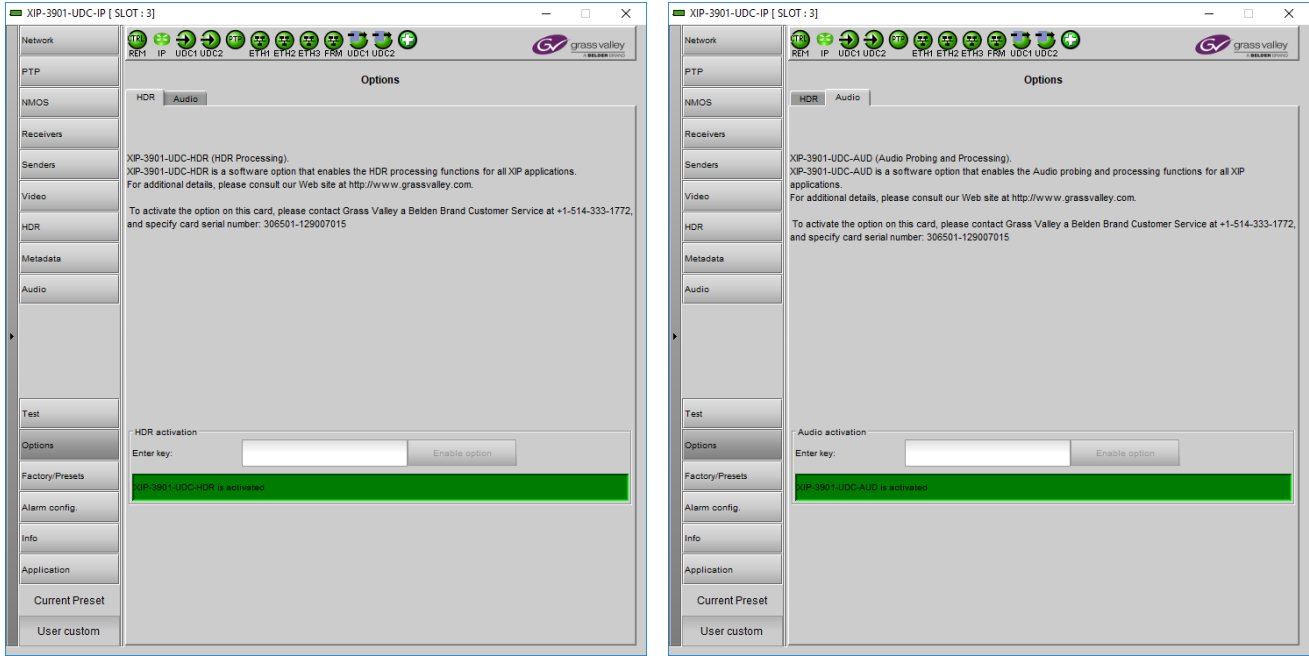

Figure 78 – Options Panel

11 Configuring the XIP 3901-GB-IP Application Using iControl

This section describes the control panels associated with the XIP-3901-GB-IP application and their use.

11.1 Network Panel

The Network panel is used to set the network configuration of the media and control Ethernet ports on the XIP-3901-GB-IP.

The XIP-3901-GB-IP's **Network** Panel configuration is the same as the XIP-3901-UCP-IP's **Network** Panel configuration, including all tabs; see 10.1 - Network Panel on page 76.

11.2 PTP Panel

To allow vertically accurate video frame synchronization, multicast Precision Timing Protocol (described in IEEE Standard 1588) is used to distribute time across a packet network. It is used on both media ports (ETH1 and ETH2) for BMCA redundancy. This supports Best Master Clock Algorithm (BMCA) as per IEEE-1588-2008.

The XIP-3901-GB-IP's **PTP** Panel configuration is the same as the XIP-3901-UCP-IP's **PTP** Panel configuration; see 10.2 - PTP Panel on page 81.

11.3 NMOS Panel

XIP-3901-GB-IP supports Networked Media Open Specifications (NMOS) AMWA IS-04 for device discovery and registration and IS-05 for connection management. Furthermore, it supports AMWA BCP-002 recommendations for Grouping NMOS Resources.

The XIP-3901-GB-IP's **NMOS** Panel configuration is the same as the XIP-3901-UCP-IP's **NMOS** Panel configuration; see 10.3 - NMOS Panel on page 83.

11.4 Receivers Panel

The Receivers panel has two tabs (**GB1** and **GB2**); one for each of XIP-3901-GB-IP's independent processing channels. The configuration of the **GB2** tab is the same as the **GB1** tab. Only the configuration of the **GB1** tab is shown below.

Each channel can:

- Receive up to four SMPTE 2110-20 video streams:
 - 4 × 3G 2SI division 1080p IP input signals
 - 4 × 3G square division 1080p IP input signals
 - 1 × 12G single-stream 2160p IP input signal
- Receive full ancillary space on one SMPTE 2110-40 metadata stream
- Receive 4 audio streams
 - Audio 1 can receive up to 64 audio channels
 - Audio 2 to 4 can receive up to 64 audio channels, but only audio channel 1 to 16 are passed through. Audio channels 17 to 64 will contain silence.

Statuses confirm that the RTP stream is being correctly received.

11.4.1 Config Tab

This tab allows you to configure the expected source media's:

- Video link operating mode associated to this input stream: single-stream 12G or quad-stream 3G.
- Audio channels, stream address, port, and IGMPv3 source.
- The receivers are SMPTE ST 2110-20 (Video), ST 2110-40 (Meta 1), and ST 2110-30 (Audio 1, Audio 2, Audio 3, And Audio 4).

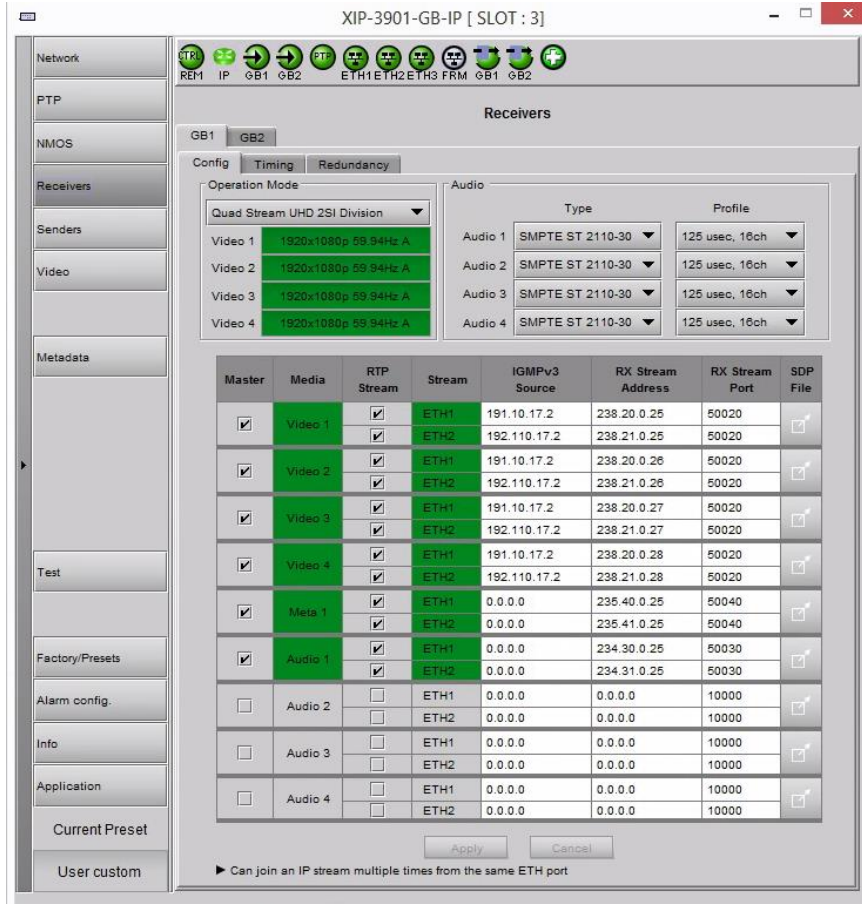

Figure 79 – Receivers Config Tab

Property	Description
Operation Mode	<p>Quad Stream UHD 2SI Division: Provide the card with 4 × 3G 2SI division 1080p IP input signals.</p> <p>Quad Stream UHD Square Division: Provide the card with 4 × 3G square division 1080p IP input signals.</p> <p>Single Stream UHD: Provide the card with 1 × 12G single-stream 2160p IP input signal.</p>
Video 1 to Video 4	<p>Shows the video source stream’s current status: resolution / frame rate or signal absence (No Carrier). The color shows the source stream’s current status:</p> <p>Green: streaming</p> <p>Red: not streaming</p> <p>Grey: not active</p> <p>When the Operation Mode is Quad Stream UHD 2SI Division or Quad Stream UHD Square Division, Video 1 to Video 4 should be green.</p> <p>When the Operation Mode is Single Stream UHD, Video 1 should be green and Video 2 to Video 4 should be grey.</p>

Property	Description
Audio	<p>Type: Use the pull-down to set the audio source stream's type for streams Audio 1 to Audio 4.</p> <ul style="list-style-type: none"> • Type SMPTE ST 2110-30: for PCM linear audio (AES67 compatible) • Type SMPTE ST 2110-31: for transparent transport of non-linear audio and data formats: provides bit-transparent AES3 over IP <p>Profile: Use the pull-down to set the audio profile for streams Audio 1 to Audio 4. Audio receivers support Level C as per SMPTE 2110-30/31: 48kHz stream from 1 to 8 channels (1 to 4 for SMPTE 2110-31) at packet times of 1ms and 1 to 64 channels (1 to 60 for SMPTE 2110-31) at packet time of 125us.</p> <p>These settings can also be managed by external NMOS control. See 11.3 - NMOS Panel on page 120.</p>
Master	<p>Set to enable a media receiver. This manages the Join/Release of both the primary and secondary streams.</p> <p>These settings can also be managed by external NMOS control. See 11.3 - NMOS Panel on page 120.</p>
Media	<p>Shows the stream type. The background shows the current media status:</p> <p>Green: no error Red: error Grey: inactive</p> <p>When the Operation Mode is Quad Stream UHD 2SI Division or Quad Stream UHD Square Division, Video 1 to Video 4 should be green.</p> <p>When the Operation Mode is Single Stream UHD, Video 1 should be green and Video 2 to Video 4 should be grey.</p>
RTP Stream	Set to enable each stream receiver individually (primary and secondary).
Stream	<p>Shows the primary (ETH1) and secondary (ETH2) stream receiver status:</p> <p>Green: no error Red: error Grey: inactive</p>
IGMPv3 Source	<p>Set the source from which to receive multicast streams. With this protocol, the card deals with a switch to subscribe to one or many streams that are coming from different sources. Both iGMPv3 and iGMPv2 protocols are supported. Set this to 0.0.0.0 if iGMP source is not used. The source range is 0.0.0.0 to 255.255.255.255. The default value is 0.0.0.0.</p> <p>These settings can also be managed by external NMOS control. See 11.3 - NMOS Panel on page 120.</p>
RX Stream Address	Set the IP address and UDP port number at which this card receives a specific stream. IP address 0.0.0.0 disables a receiver. The default UDP port values are:
RX Stream Port	<ul style="list-style-type: none"> • 10000 for all media receivers. <p>These settings can also be managed by external NMOS control. See 11.3 - NMOS Panel on page 120.</p>
SDP File	Click to show the last SDP file received through NMOS IS-05 since the last bootup. This window does not refresh automatically; you need to close and re-open the window to see an update. If the card has never received an SDP file since last its last bootup, the window will be empty.
Apply Cancel	When active, this applies or rejects your current changes made in this tab except for Operation Mode , Audio type and Audio Profile

11.4.2 Timing Tab

This tab allows you to view the network health of the stream's connection (link latency, receiver buffer level, and offset time).

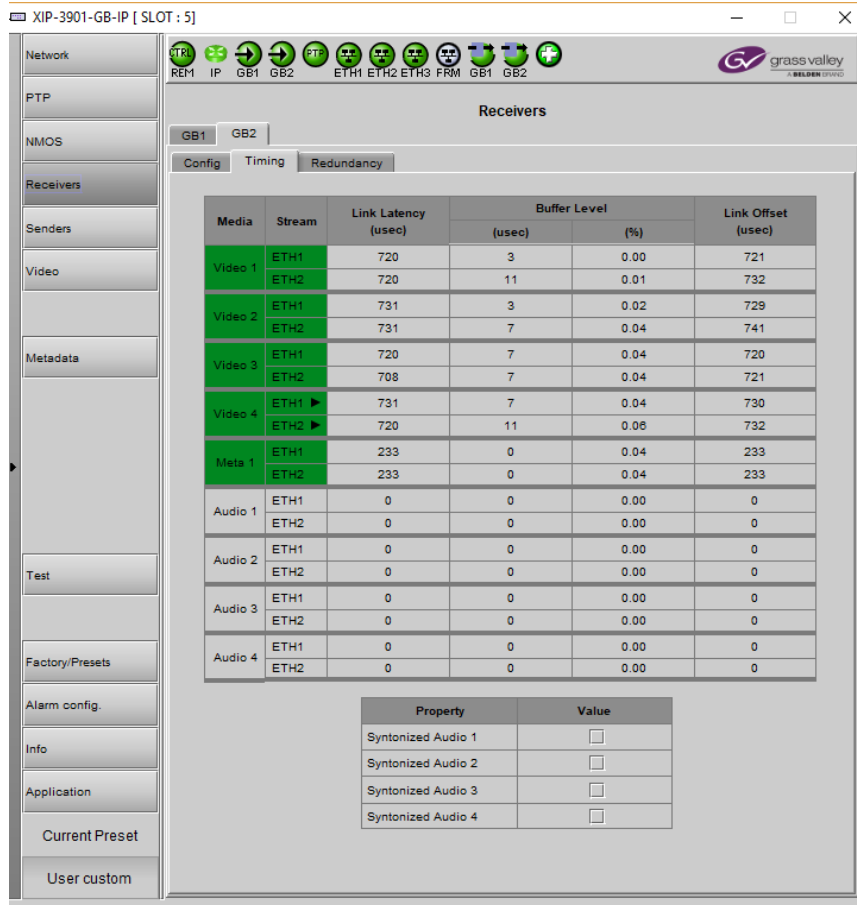

Figure 80 – Receivers Timing Tab

Property	Description
Media	Shows the stream type. The background shows the current media status: Green: No error Red: Error Grey: Inactive
Stream	Shows the primary (ETH1) and secondary (ETH2) stream receiver status: Green: No error Red: Error Grey: Inactive
Link Latency	Shows the time it takes for a packet to come from the source to the receiver. This measurement represents the difference between incoming RTP timestamp and PTP time before the receiver's buffer.
Buffer level	Shows the amount of preloaded data stored in the receiver that is ready for use in microseconds and in percentage. The current buffer level in microseconds shows the minimum latency required to receive a continuous stream. The current buffer level in percentage shows how much of the internal buffering is used to receive the current stream.

Property	Description
Link Offset	Shows the resulting link latency after being read out from receiver's buffer. This measurement is the difference between the packet RTP timestamp and the PTP time after the receiver's buffer and represents the total reception delay.
Syntonized Audio 1 to 4	Set to ignore Audio RTP timestamps. Audio buffer reception is then fixed to 25%. Use these settings to manage audio streams that are not properly time stamped. Enable syntonize for audio 1 to 4 individually.

11.4.3 Redundancy Tab

This tab allows you to view the reception state regarding SMPTE ST 2022-7 redundancy. The primary and secondary streams, at the packet level, will work together in order to produce a valid resulting stream. To achieve redundancy, both streams need to be in range with respect to the receiver buffer. In the circumstance in which only one stream is successfully received, the resulting stream will be valid as well but without any active redundancy protection.

The XIP-3901-GB-IP's **Receivers** Panel, **Redundancy** tab configuration is the same as the XIP-3901-UCP-IP's **Receivers** Panel, **Redundancy** tab configuration; see 10.4.3 - Redundancy Tab on page 88.

11.5 Senders Panel

The Senders panel has three tabs (**GB1**, **GB2**, and **Advanced**); **GB1** and **GB2** are for each of XIP-3901-GB-IP's independent processing UHD channels. These tabs configure the SMPTE ST 2110 outputs. The configuration of the **GB2** tab is the same as the **GB1** tab. Only the configuration of the **GB1** tab is shown below.

Each channel can:

- Send up to four SMPTE 2110-20 video streams:
 - 4 × 3G 2SI division 1080p IP output signals
 - 4 × 3G square division 1080p IP output signals
 - 1 × 12G single-stream 2160p IP output signal
- Send full ancillary space on one SMPTE 2110-40 metadata stream
- Send 4 audio streams
 - Audio 1 can send up to 64 audio channels
 - Audio 2 to 4 can send up to 64 audio channels, but only audio channel 1 to 16 are passed through. Audio channels 17 to 64 will contain silence.

Statuses confirm that the RTP stream is successfully streaming.

11.5.1 GB1 / GB2 Tabs

This tab allows you to configure the destination media's video format, audio channels, stream IP addresses and port numbers.

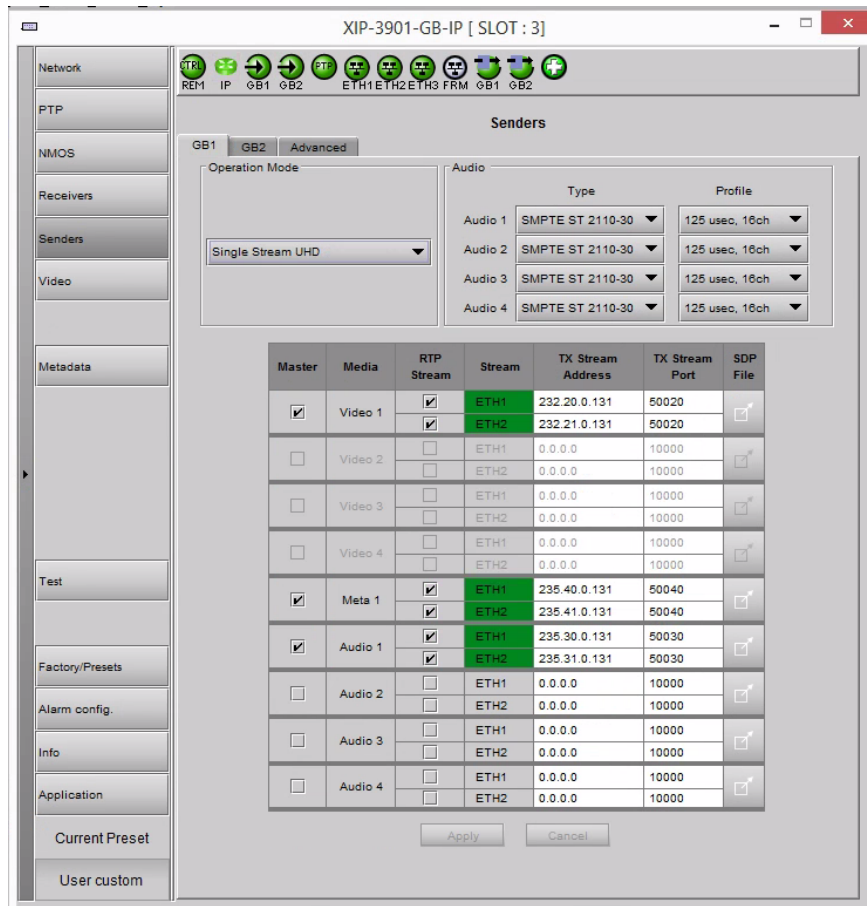

Figure 81 – Senders Config Tab

Property	Description
Operation Mode	Quad Stream UHD 2SI Division: Sends 4 × 3G 2SI division 1080p IP output signals. Quad Stream UHD Square Division: Sends 4 × 3G square division 1080p IP output signals. Single Stream UHD: Sends 1 × 12G single-stream 2160p IP output signal.
Audio	Type: Use the pull-down to set the audio stream’s type for streams Audio 1 to Audio 4 . <ul style="list-style-type: none"> Type SMPTE ST 2110-30: for PCM linear audio (AES67 compatible) Type SMPTE ST 2110-31: for transparent transport of non-linear audio and data formats. Provides bit-transparent AES3 over IP. Profile: Use the pull-down to set audio profile for streams Audio 1 to Audio 4 . Audio receivers support Level C as per SMPTE 2110-30/31: 48kHz stream from 1 to 8 channels (1 to 4 for SMPTE 2110-31) at packet times of 1ms and 1 to 64 channels (1 to 60 for SMPTE 2110-31) at packet time of 125us. These settings can also be managed by external NMOS control. See 11.3 - NMOS Panel on page 120 .
Master	Set to enable a media sender. This manages both the primary and secondary streams. This can also be managed by external NMOS control. See 11.3 - NMOS Panel on page 120 .
Media	Shows the stream type.
RTP Stream	Set to enable a media stream sender for primary and secondary. This can also be managed by external NMOS control. See 11.3 - NMOS Panel on page 120 .
Stream	Shows the primary (ETH1) and secondary (ETH2) streaming status: Green: streaming Red: not streaming Grey: not active When the Operation Mode is Quad Stream UHD 2SI Division or Quad Stream UHD Square Division , the streams for Video 1 to Video 4 should be green. When the Operation Mode is Single Stream UHD , the streams for Video 1 should be green and the streams for Video 2 to Video 4 should be grey.
TX Stream Address	Set the IP address and UDP port number of the outgoing stream. IP address 0.0.0.0 disables a sender. The default UDP port values are 10000.
TX Stream Port	Address & UDP port can also be managed by external NMOS control. See 11.3 - NMOS Panel on page 120 .
SDP File	Click to show the last SDP file transmitted through NMOS since the last bootup. This window does not refresh automatically; you need to close and re-open the window to see an update. If the card has never received an SDP file since its last bootup, the window will be empty.
Apply Cancel	When active, this applies or rejects your current changes made in this tab except for Audio Type and Audio Profile

11.5.2 Advanced Tab

This tab allows you to configure the outgoing payload type and DSCP priority for SMPTE 2110-20 (Video), SMPTE 2110-40 (Meta 1) and SMPTE 2110-30/31 (Audio 1 to Audio 4). These setting apply to both **GB1** and **GB2** tabs.

The XIP-3901-GB-IP’s **Senders Panel, Advanced** tab configuration is the same as the XIP-3901-UCP-IP’s IP’s **Senders Panel, Advanced** tab configuration; see 10.5.2 - Advanced Tab on page 92.

11.6 Video Panel

The Video panel has two tabs (**GB1** and **GB2**); one for each of XIP-3901-GB-IP's independent processing channels. The configuration of the **GB2** tab is the same as the **GB1** tab. Only the configuration of the **GB1** tab is shown below.

11.6.1 Timing Tab

For each processing channel, you can adjust the timing relative to the reference. Use the slider or type a value into the data box on the right of the slider. Metadata and audio streams will match the video delay set below.

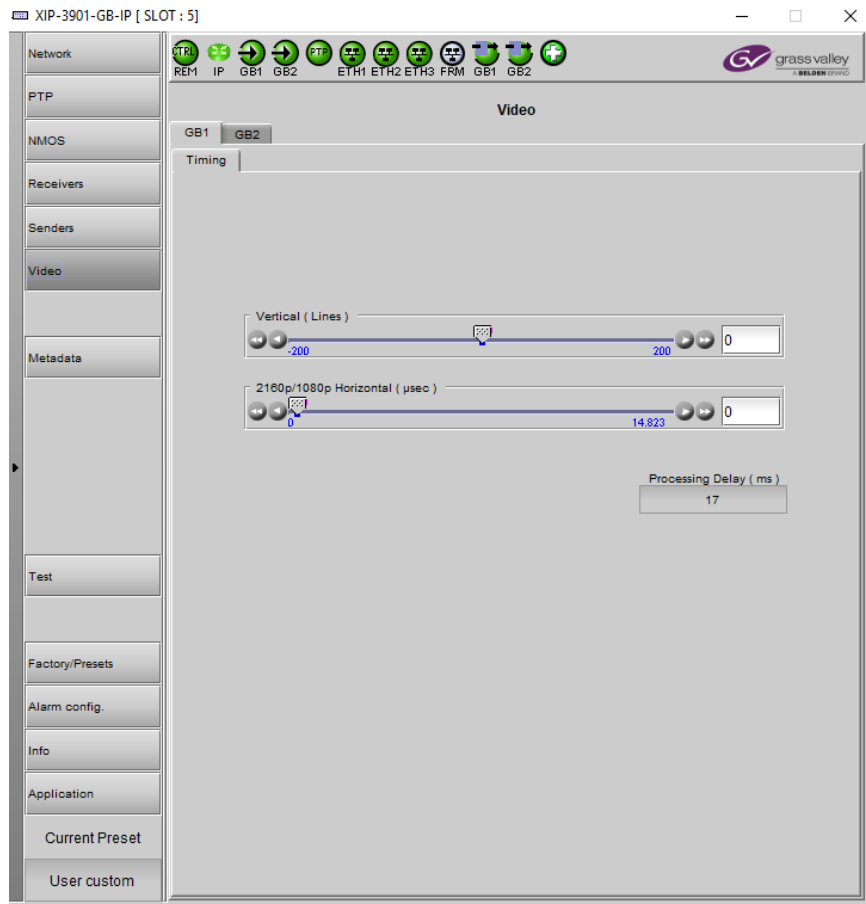

Figure 82 – Video Timing Tab

The following adjustment sliders are available:

Adjustment	Range (50 Hz)	Range (59 Hz)	Description
Vertical (Lines)	-200 to +200	-200 to +200	Vertical setting applies to all output formats.
2180p/1080p Horizontal (µsec)	0 to 17.771 µsec	0 to 14.825 µsec	Horizontal settings are specific to individual output formats.

This section also displays the Processing Delay in microseconds so you can manage the processing delay on your system.

The XIP-3901 has an integrated frame sync that supports synchronous and asynchronous input signals. The input signals will be synchronized and realigned to PTP.

The frame sync behaves like a frame buffer. It also supports frame skips/repeats in the case of an asynchronous SDI input. When an input error occurs, it freezes to the last valid field/frame.

1. On a skip/repeat frame, PCM audio will take up to 15 seconds to track. For non-PCM audio, it will instantly catch-up.
2. On skip/repeat frame, metadata is skipped or duplicated.
3. On freeze, audio is muted and metadata is blanked

The following table shows the amount of time for a vertical line.

Input Video Format	Output Video Format	Line length	Description
3840x2160p 59Hz	3840x2160p 59Hz	14.825 μ sec	Frame rate follows detected input video format
3840x2160p 50Hz	3840x2160p 50Hz	17.771 μ sec	

11.7 Metadata Panel

The XIP-3901-GB-IP manages the transfer of metadata between its input and output, but does not process the metadata information regarding the video conversion. In the Metadata Panel, you can selectively pass or block any one of eight specific ANC data types by specifying the DIDs and SDIDs to be passed from input to output and those that are to be blocked.

The XIP-3901-GB-IP's **Metadata** Panel configuration is the same as the XIP-3901-UCP-IP's IP's **Metadata** Panel configuration; see 10.8 - Metadata Panel on page 105.

11.8 Test Panel

You may activate the Color Bars & Tone test signal for the two channels independently by enabling the appropriate checkboxes.

The XIP-3901-GB-IP's **Test** Panel configuration is the same as the XIP-3901-UCP-IP's IP's **Test** Panel configuration; see 10.10 - Test Panel on page 117.

12 Common Configuration Panels to all XIP-3901 Applications

12.1 Factory/Presets Panel

This panel provides access to three functions, which apply only to the current application (unlike the restore point, which saves the settings for all applications on the platform).

- User Presets. See 12.1.1 - User Presets on page 131.
- Factory. See 12.1.2 - Load Factory button on page 132.
- Profiles. See 12.1.3 - Profiles on page 133.

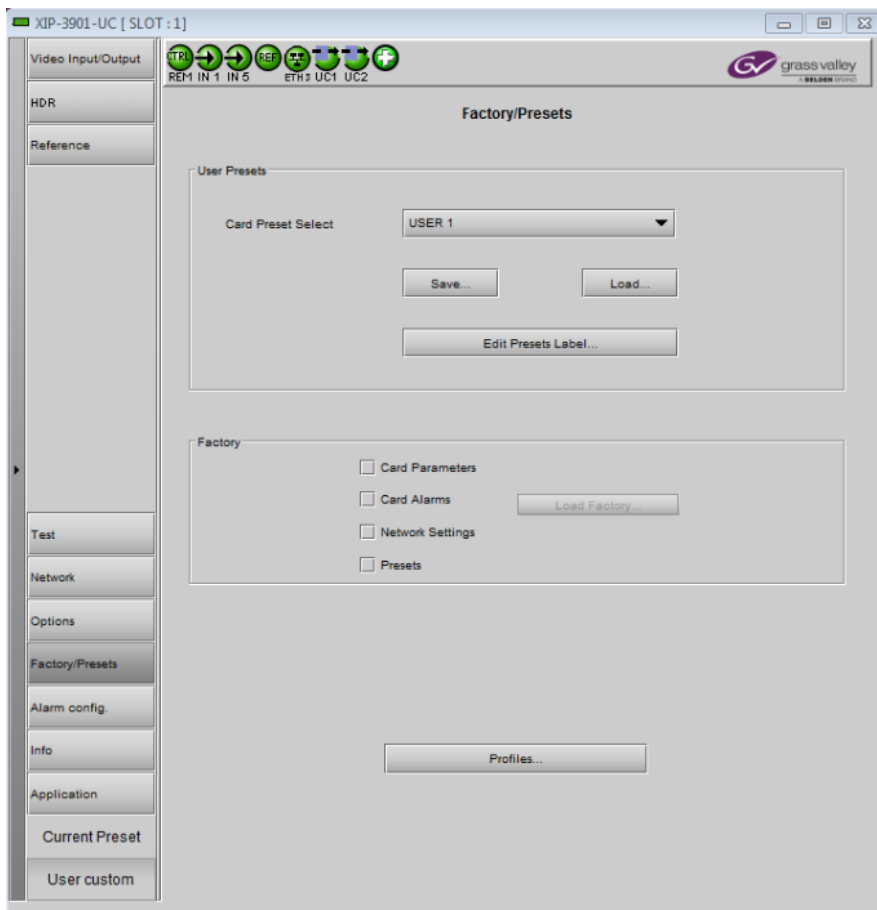

Figure 83– Factory/Presets Panel (Shown on XIP-3901-UC)

At the bottom left of the window, the Current Preset field displays the presets that are currently used on the XIP-3901 application. Possible values are:

- Factory default
- User defined presets (for example, USER 1)
- User custom (when a setting has been modified from a defined preset or factory default settings)

12.1.1 User Presets

Each XIP-3901 application has memory registers that can hold up to five user-defined parameter settings.

Select any one of the five presets using the Card Preset Select pulldown menu.

Click **Load** to load the contents of the selected user preset into the XIP-3901 application. All parameter settings and values will be replaced by the contents of the selected user preset.

A confirmation box will pop up to allow you to proceed or cancel the load.

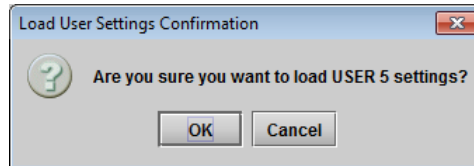

Figure 84–Load User Settings Confirmation Box

Click **Save** to store the current parameter settings and values from the XIP-3901 application in the selected user preset. The existing contents of the preset will be overwritten. A confirmation box will pop up to allow you to proceed or cancel the save.

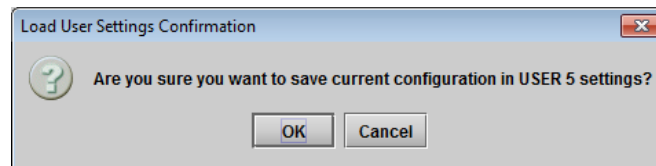

Figure 85–Save Configuration Confirmation Box

You can edit the name assigned to each user preset.

- Click **Edit Presets Label** to open the Presets window.
- Double-click on a name in the Label column.
- Type a new name in the window.
- Click **OK**.

The text you have entered (up to 16 characters) will be appended to the label name in the pulldown menu.

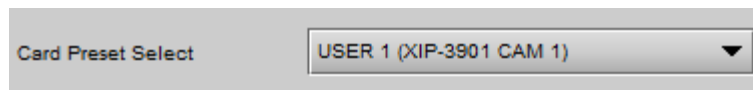

Figure 86– Card Preset Select

12.1.2 Load Factory button

Clicking the Load Factory button will restore the card to a factory default state. Four checkboxes can be used to choose whether to include card parameters, card alarms, network settings and presets in the restoration process.

Note: Card alarms are reset to factory values; iControl alarms and GSM alarms are not reset. With reference to the Alarm Configuration panel:

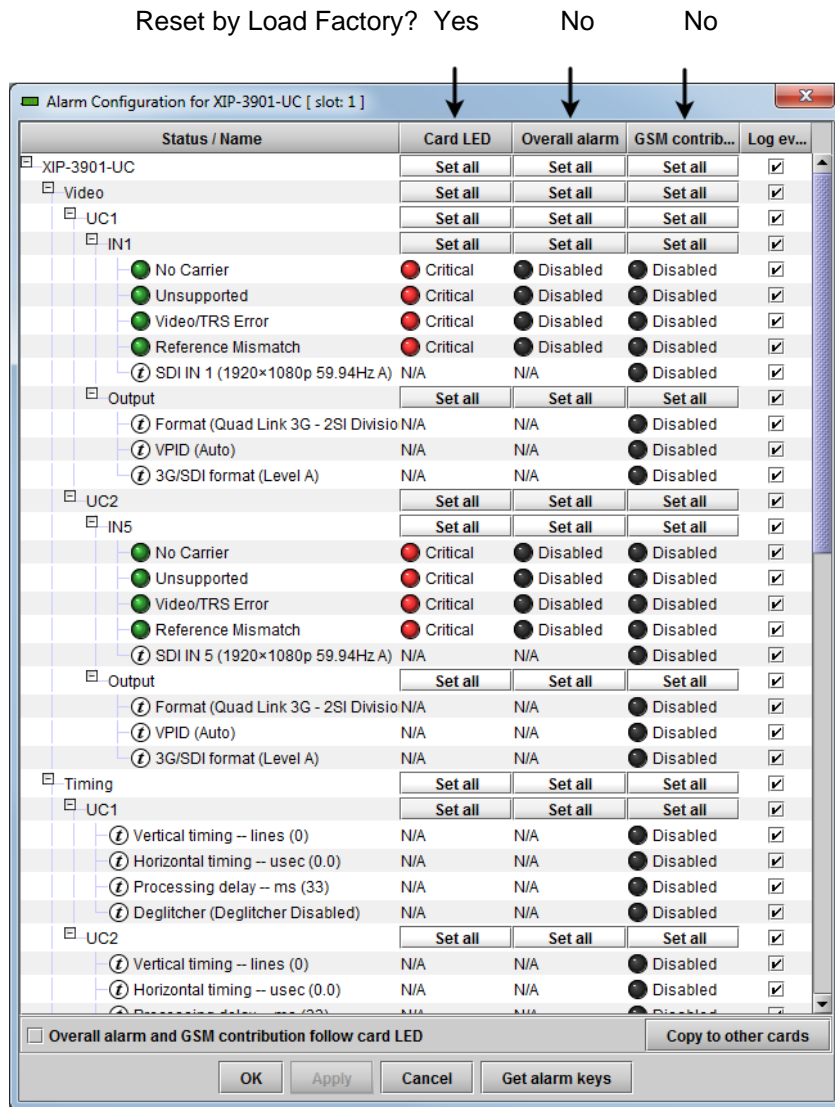

Figure 87–Alarm Types Reset by Load Factory (Shown on XIP-3901-UC)

12.1.3 Profiles

Use Profiles to save or recover the entire card configuration (including user presets if desired) on an external disk, or to copy it to another XIP-3901 card located in any Densité frame in the system.

Click **Profiles** to open the Profile Copy window.

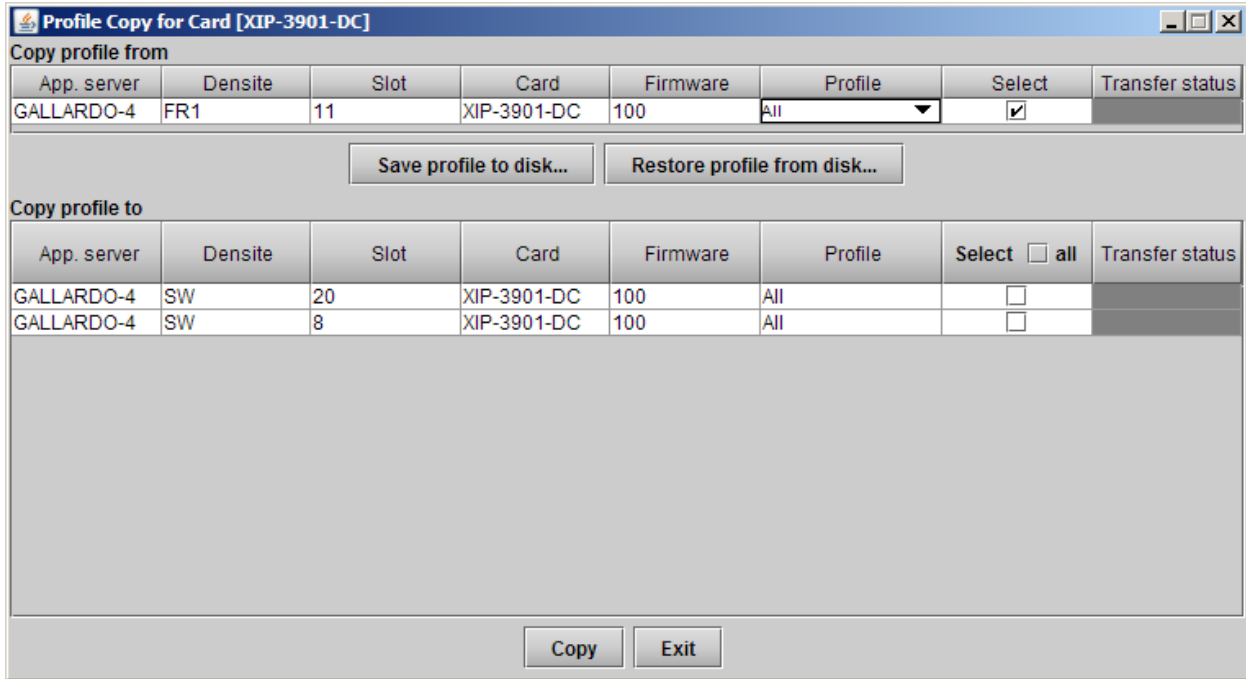

Figure 88–Profile Copy for Card (Shown on XIP-3901-DC)

Copy profile from

This line shows the XIP-3901 card and its App. server, Densité frame, slot number, card type, firmware version and profile.

The Profile column has a pulldown menu that allows you to select from the following options:

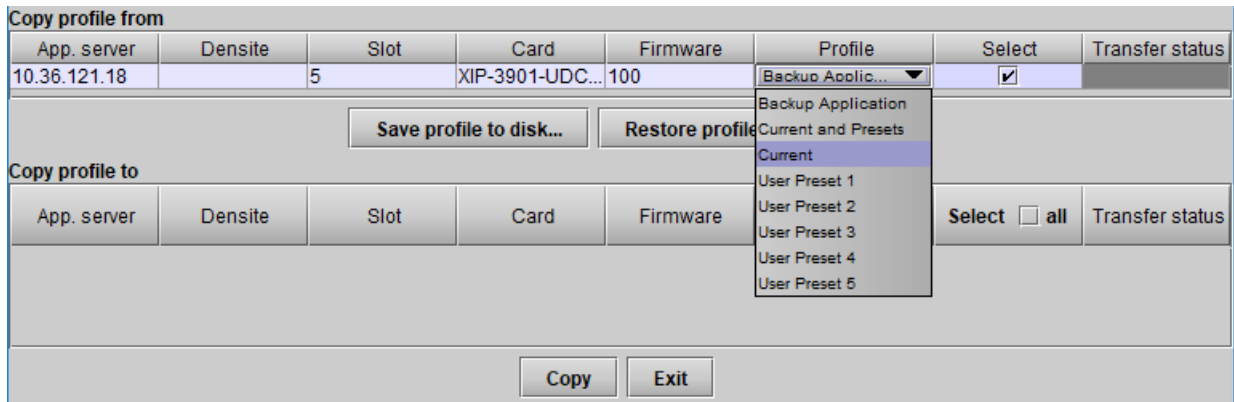

Figure 89–Profile Column Pulldown Menu

Property	Description	Profile Option Saves	
		Card Parameters	Receivers / Senders Configuration, Alarms, NMOS, PTP, and Ethernet / Network
Backup Application	The card's current configuration and all presets will be copied or saved to disk.	<input checked="" type="checkbox"/>	<input checked="" type="checkbox"/>
Current and Presets	Part of the current configuration and presets will be copied or saved to disk.	<input checked="" type="checkbox"/>	
Current	Only the card's current configuration will be copied or saved on disk.	<input checked="" type="checkbox"/>	
User Presets 1 - 5	Only the selected preset will be copied or saved on disk.	<input checked="" type="checkbox"/>	

The Select column includes a checkbox (pre-checked) to confirm that you want to work with the current card.

Save profile to disk...

After selecting which profiles to save, click this button to open a Save dialog. Specify a file name and location to which the selected profiles for this card will be saved.

Note: It is a good idea to create a folder for these files, because they are not explicitly identified as XIP-3901 profiles and will be difficult to identify if not clearly named and conveniently located.

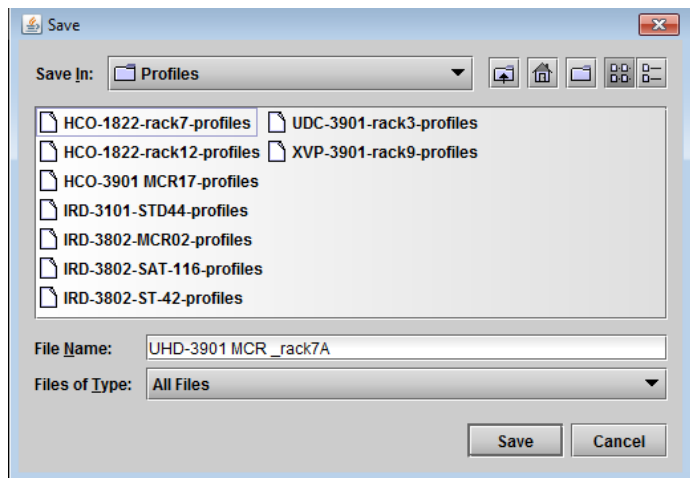
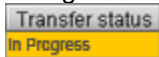
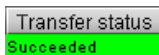

Figure 90–Save Profile to Disk Dialog

- Click **Save** once the name and location have been identified in the Save box. The Transfer Status box on the right of the Copy profile from line will indicate In Progress against a yellow background.



- If the file was saved correctly, the Transfer Status box will indicate Succeeded against a green background.



- If the file was not saved for some reason, the Transfer Status box will indicate Failed against a red background.



Restore profile from disk...

Click this button to open an Open dialog box to locate and select a valid XIP-3901 profile file.

- Click **Open** to read the contents of the file and reconfigure the XIP-3901's profiles accordingly.
- While the reconfiguration is in progress, the Transfer Status box on the right of the Copy profile from line will indicate Working against a yellow background.
- When the reconfiguration is complete, the Transfer Status box will indicate Succeeded against a green background.

On a restore profile from disk, there is no need to select a profile type (ALL, Current, User1 to User5). All the profile contents of the file will be restored.

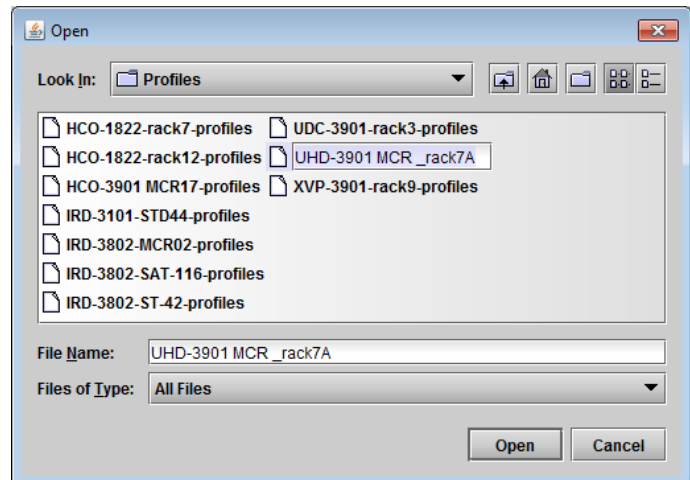

Figure 91—Restore Profiles from Disk Dialog

Copy profile to

This section shows other XIP-3901 cards that are available on the iControl network, each identified by its app. server, Densité frame, slot number, card type and firmware version.

The **Profile** column shows the same setting as selected for the current card in the **Copy profile from** line. See Figure 89.

The **Select** column includes a checkbox to identify the XIP-3901 cards to which profiles will be copied from the current card.

- For convenience, a Select all checkbox is provided in the column header.

Click **Copy** to copy the selected profiles from this card into the selected other XIP-3901 cards.

- While the profile copy operation is in progress, the Transfer Status box on the right of the Copy profile to line will indicate Working against a yellow background.
- When the profile copy operation is complete, the Transfer Status box on the right of the Copy profile to line will indicate Succeeded against a green background.

Note: The source and destination cards must have the same firmware version. Any destination cards with a different firmware version that are shown in the Copy profile to list cannot be selected, and their transfer status is always N/A on a yellow background.

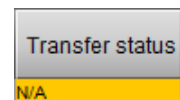

12.2 Alarm Config Panel

This panel is used to configure the alarm reporting of the XIP-3901 application. The panel opens in a new window when the button is clicked and can be resized.

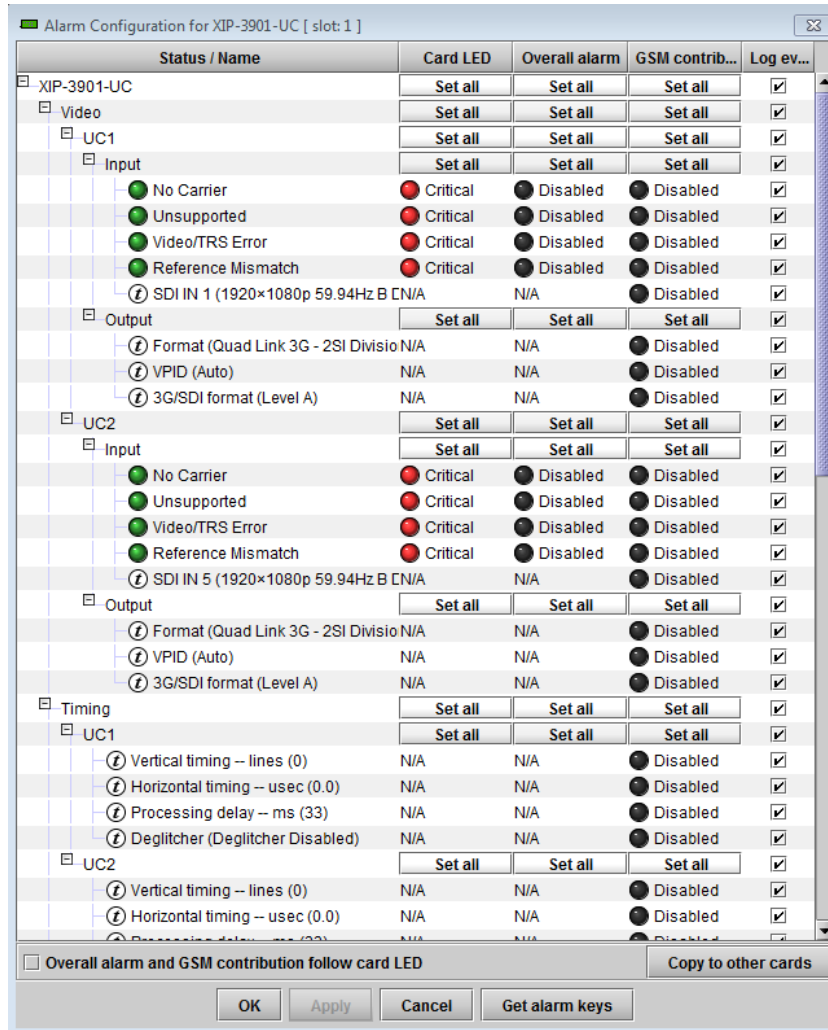

Figure 92–Alarm Configuration (Shown on XIP-3901-UC)

Status/Name

This column contains an expandable tree listing all the alarms reported by this XIP-3901 card.

- Each alarm name includes an icon that shows its current status.
- Some alarms may be text-only, and the alarm status is shown in the name and not by a status icon.

Card LED, Overall Alarm and GSM Contribution

These columns contain pulldown menus used to set the severity level of each individual alarm to the alarm named in the column heading. This can be set independently for Card LED, Overall Alarm and GSM Contribution.

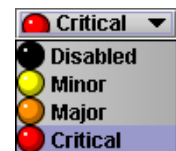

Card LED

This column is used to set the severity level of the selected individual alarm to the status LED located on the front card-edge. The Card LED status is shown at the bottom of the alarm tree in the Status/Name column. If at least

one Critical or Major alarm is triggered, the LED will change to red. If no Critical or no Major alarms are triggered and Minor alarms are occurring, the LED will change to yellow.

Overall Alarm

This column is used to set the severity level of each individual alarm to the Overall Alarm associated with the card. The Overall Alarm is shown in the upper left corner of the iControl panel and also appears at the bottom of the Status/Name column.

GSM Contribution

This column is used to set the severity level of each individual alarm to the GSM Alarm Status associated with this card. GSM is a dynamic register of all iControl system alarms and is also an alarm provider for external applications. The possible values for this contribution are related to the Overall Alarm contribution:





- If the Overall Alarm contribution is Disabled, the GSM alarm contribution can be set to any available value.
- If the Overall Alarm contribution is any level other than Disabled, the GSM contribution is forced to follow the Overall Alarm.

Log Events

iControl maintains a log of alarm events associated with the card. The log is useful for troubleshooting and identifying event sequences. Check the box to log alarm events for each individual alarm.

Levels associated with these alarms:

The pulldown menus may contain some or all of the following settings:

- | | | |
|---|-------------|---|
|  | Disabled | The alarm makes no contribution (black icon) |
|  | Minor | The alarm is of minor importance (yellow icon) |
|  | Major | The alarm is of major importance (orange icon) |
|  | Critical | The alarm is of critical importance (red icon) |
|  | Passthrough | The alarm exists but has no effect (used for text and composite alarms) |

Note: As a shortcut, you can click one of the Set All boxes beside a section heading to open a pulldown menu that lets you assign a level to all alarms in that section of the column simultaneously.

Once the alarms are configured, you may accept the changes or discard them:

Overall alarm and GSM contribution follow card LED

Check the box to force the Overall Alarm and GSM contribution to match the Card LED status.

- All Overall Alarms and GSM contributions for which there is a Card LED alarm will be forced to match the Card LED alarm.
- All Overall Alarms and GSM contributions for which there is no Card LED alarm will be forced to be Disabled.

A warning dialog box will open to ask you to confirm the action, since it will change the configuration and cannot be undone.

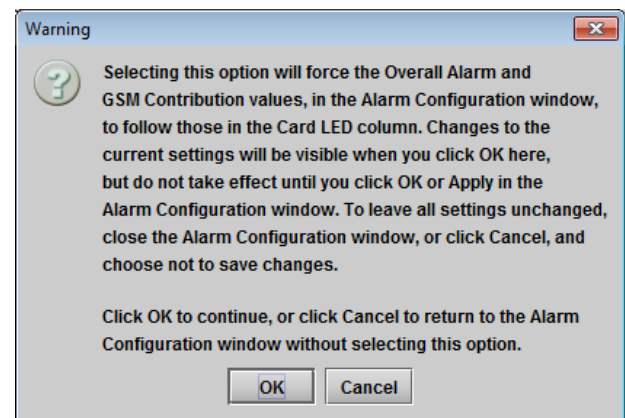

Figure 93–Warning for Follow LED Change

Copy to other cards

Click this button to open a panel that is used to copy the alarm configuration set for this card to another XIP-3901 card.

- Select one or more destination cards from the list in the window by checking the boxes, or check **All** to select them all.
- Note that when you copy a profile for the XIP-3901 card (see 12.1.3 - Profiles), the alarm configuration is copied along with all the other settings.

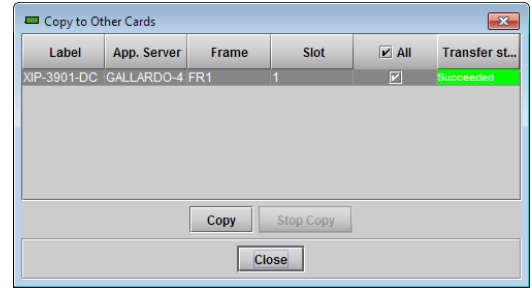

Figure 94–Copy to Other Cards Window

Get alarm keys

Click this button to open a save dialog where you can save a file containing a list of all alarms on this card and their current values, along with an alarm key for each. The alarm keys are useful for system integration and troubleshooting.

- The file is saved in .csv format.

OK, Apply, Cancel

- **OK:** Accepts the settings and closes the window once the card confirms that there are no errors.
- **Apply:** Accepts the settings but leaves the window open.
- **Cancel:** Closes the window without applying any changes and leaves the previous settings intact.

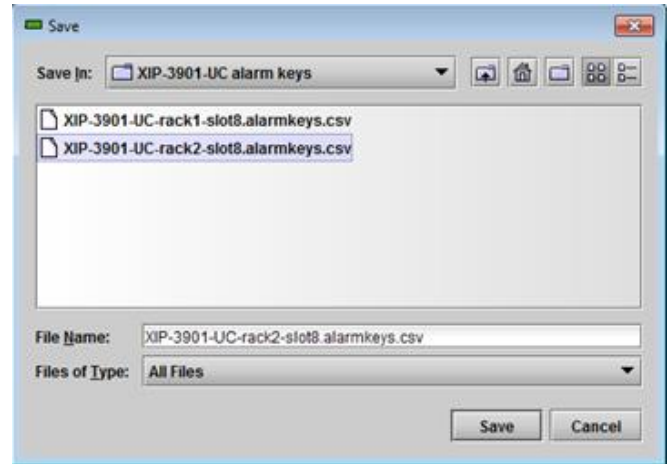

Figure 95–Get Alarm Keys Dialog

12.3 Info Panel

When the XIP-3901 is included in an iControl environment, certain information about the card should be available to the iControl system. You can enter labels and comments that will make this card easy to identify in a complex setup. This information is entered into data boxes in the Info control panel.

- **Label:** Enter the label that appears for the XIP-3901 application in iControl applications.
- **Short label:** Enter the short-form label sometimes used by iControl (8 characters).
- **Source ID:** Enter a descriptive name for the XIP-3901 application.
- **Comments:** Enter any desired text.

The remaining data boxes show manufacturing information about the card.



Figure 96– Info Panel (Shown on XIP-3901-UC)

Three buttons in the panel give access to other information.

- **Details...:** Reports the service version and panel version for the card.

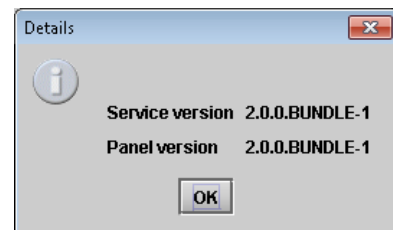

Figure 97–Details Window

- **Advanced...:** Shows the Long ID for this card. The Long ID is the address of this XIP-3901 application on the iControl network.

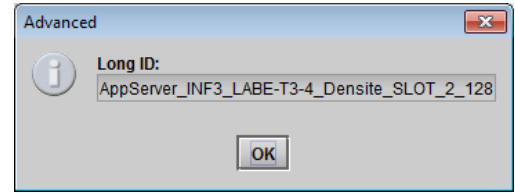

Figure 98—Advanced Window

- **Remote system administration...:** Opens the *Joining Locators* window, which lists the remote lookup services to which this XIP-3901 application is registered.

Add: Force the iControl service for this XIP-3901 application to register itself on a user-specified Jini lookup service, using the following syntax in the data box:

jini://<ip_address>

where <ip_address> is the IP address of the server running the lookup service:

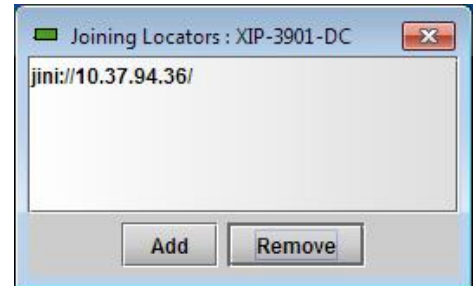

Figure 99—Joining Locators Window

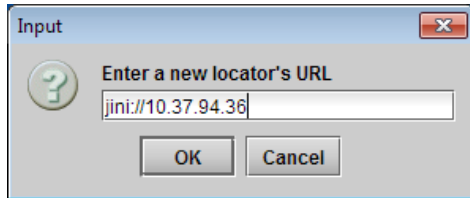

Figure 100— Add Window

Remove: Click to select one of the services listed in the window and click **Remove**. A confirmation dialog box will appear.

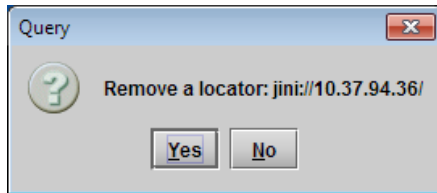
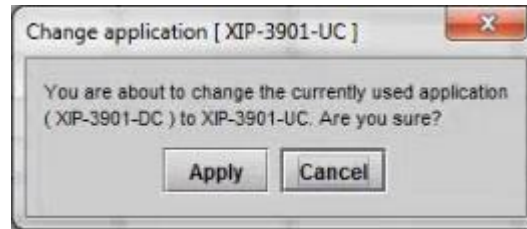

Figure 101— Remove Window

To switch to a different application:

1. Select the **In Use** radio button for the application you wish to use.
2. In the Change application dialog box, click **Apply**.
3. Wait several seconds for the application to reboot.



13 Fan Replacement

In the event of a fan failure, Grass Valley has replacement fans available that can be installed in the field. Contact Grass Valley Customer Support for details.



Figure 103—Fan Assembly on the XIP-3901 Card

13.1 Required Materials

To replace the fan assembly on the XIP-3901 card, you will need:

- XIP-3901-FAN Fan Assembly Replacement Kit
- Anti-static mat
- Needle-nose pliers
- Tweezers

13.2 Procedure

Step 1: Remove the failed fan assembly

1. Remove the XIP-3901 card from the Densité frame.
2. Flip the card over on an anti-static mat so that you can see the rear (solder side) of the card.

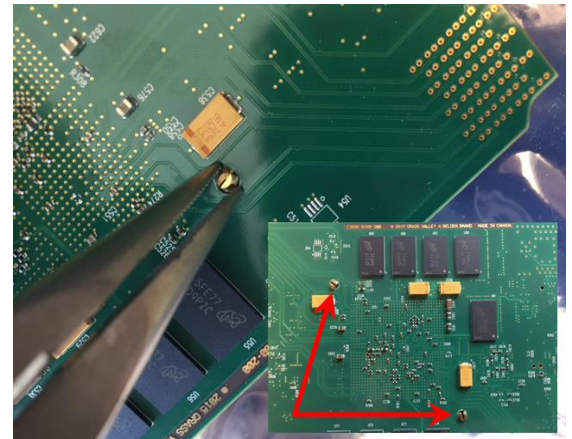

Figure 104—Compressing the Pushpins

INSTALLATION AND OPERATION GUIDE

3. Using needle-nose pliers, compress the two pushpins so that they unlatch. Push the pin through the card to release it from the assembly.
4. Flip the card back to the component side. Insert the pliers under the one of the pushpin heads. Press down on the center of the fan assembly to prevent it from flipping on its side and gently pry the pin from the heatsink assembly. Repeat for the second pushpin.
5. Remove the wires from both wire clips on the fan assembly.
6. Note the position of the black wire to assist with reconnecting the replacement assembly.
7. Use tweezers to gently disconnect the power connector on the fan assembly from the card.
8. Dispose of the failed fan assembly.

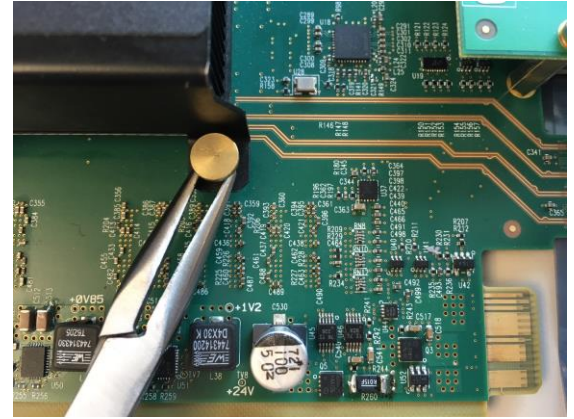

Figure 105—Prying Out the Pushpins

Step 2: Install the new fan assembly

1. Connect the power connector for the replacement fan assembly to the FAN 1 jack on the card.
2. Insert the wires for the fan assembly into the wire clips.
3. Place the fan assembly on the heatsink and align the two pushpins with their respective holes on the card.
4. Press down on the fan assembly to hold it in place and press the pushpins into the holes until they lock into place.

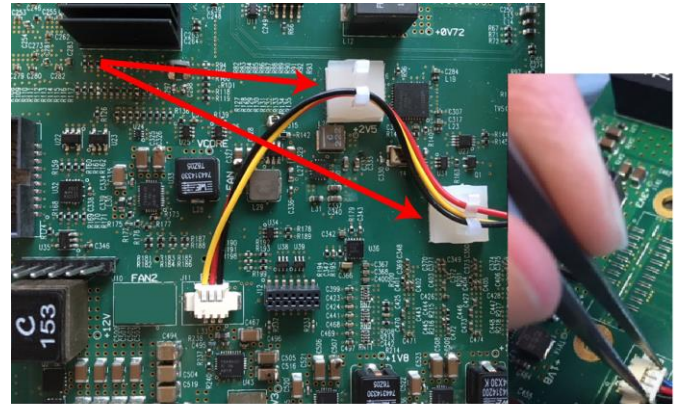

Figure 106—Removing the Wires and Connector

14 Specifications

SDI (Inputs/Outputs); XIP-3901-UC / -DC / -FS Applications

Physical:	16 DIN connectors: 8 IN, 8 OUT
SDI Standard:	SMPTE ST 292 (1.485, 1.485/1.001 Gb/s) SMPTE ST 424 (2.970, 2.970/1.001Gb/s) SMPTE ST 2082-1:2015 (on DIN IN 1 & 5 and OUT 1 & 5)
Supported formats:	HD: SMPTE ST 274: 1080i59.94, 1080i50 HD: SMPTE ST 296: 720p59.94, 720p50 3G: SMPTE ST 425 Level A (mapping 1), level B: 1080p59.94, 1080p50 4K UHD: Quad Link 3 Gb/s SMPTE ST 425-5: 1080p59.94, 1080p50 12G: SMPTE-2082-10: 2160p59.94, 2160p50
Cable length (Belden 1694A):	HD: 250m (820 ft.) at 1.485 Gb/s 3G: 150m (492 ft.) at 2.970 Gb/s 12G: 60m (197 ft.) at 11.88 Gb/s
Jitter:	HD: <0.2 UI (alignment jitter) 3G: <0.3 UI (alignment jitter) 12G: <0.3UI (alignment jitter)

Reference Input; XIP-3901-UC / -DC / -FS Applications

Signal:	SMPTE ST 170 / SMPTE ST 318M / ITU 624-4 blackburst
---------	---

Ethernet Port (Control)

Physical:	1 RJ45 port
Standard:	IEEE 802.3 1,000 Mb/s Ethernet

Media Ports; XIP-3901-UDC-IP & XIP-3901-GB-IP Applications

Physical:	Two SFP+ sockets
Performance:	Up to 25 Gb of streaming per direction
Compatible SFP+ Cartridges:	GV SFP-25G-SR: SFP28 25GBASE Optical Transceiver MMF GV SFP-25G-LR: SFP28 25GBASE Optical Transceiver SMF Cisco SFP-25G-AOC-xM: 25GBASE Active Optical SFP28 Cable 2, 3 and 5 meter

Video Processing Performance

Signal path: 10 bits minimum

Latency: No reference: 33 ms (59Hz)
40 ms (50Hz)
With reference: 28 ms to 61 ms (59Hz)
32 ms to 72 ms (50Hz)

3G Output Minimum Delay: Fewer than 4 video lines

Electrical

Power: 60 W maximum (XIP-3901-UDC-IP)
50 W maximum (XIP-3901 UC / -DC / -FS & XIP-3901-GB-IP)

15 Contact Us

Grass Valley Technical Support

For technical assistance, contact our international support center at 1-800-547-8949 (US and Canada) or +1 530 478 4148.

To obtain a local phone number for the support center nearest you, please consult the Contact Us section of Grass Valley's website (www.grassvalley.com).

An online contact form is also available on the [Contact Customer Support](#) page of the website.

Corporate Head Office

Grass Valley
3499 Douglas B. Floreani St.
St. Laurent, QC H4S 2C6
Canada

Telephone: +1 514 333 1772
Fax: +1 514 333 9828

www.grassvalley.com

APPENDIX A – Local Menu

1st Level	2nd Level	3rd Level	4th Level	Comments/Default Value
Status	Current Application			XIP-3901-UC, XIP-3901-DC, XIP-3901-FS, XIP-3901-UDC-IP, XIP-3901-GB-IP
	ETH1	LINK STATUS		
		IP ADDRESS		
		NETMASK		
		GATEWAY		
		MAC ADDRESS		
	ETH2	as per ETH1		
ETH3	as per ETH1			
FRAME	as per ETH1			
NETWORK CONFIG	ETH1	MODE	STATIC, DHCP, OFF	
		IP ADDRESS	XXX.XXX.XXX.XXX	
		MASK	XXX.XXX.XXX.XXX	
		GATEWAY	XXX.XXX.XXX.XXX	
	ETH2	as per ETH1	as per ETH1	
	ETH3	as per ETH1	as per ETH1	
	FRAME	as per ETH1	as per ETH1	
VERSION	X.Y.Z.B			X major Y minor Z revision B build
	FPGA: X.Y.Z.B			
	UBOOT: X.Y.Z			
APPLICATIONS	XIP-3901-UC vX.Y.Z.B			When present on platform
	XIP-3901-DC vX.Y.Z.B			When present on platform
	XIP-3901-FS vX.Y.Z.B			When present on platform
	XIP-3901-UDC-IP vX.Y.Z.B			When present on platform
	XIP-3901-GB-IP vX.Y.Z.B			

APPENDIX B – Installing the Optical Interface

Installing and removing the Fiber I/O interface cartridge requires special care. This annex describes the process. Some rear panels used with the MDX-3901 incorporate a fiber optic interface. The interface consists of two parts:

- A socket on the rear panel into which an SFP interface module is plugged
- An SFP (Small Form-factor Pluggable) module into which the optical fibers are plugged, and which incorporates the optical/electrical interface

Cautions and Warnings



SFP Transmitter modules contain a class 1 laser, which emits invisible radiation whenever the module is powered up. Because the SFP is hot-swappable, the module may be powered up as soon as it is installed.

DO NOT LOOK INTO AN OPERATING SFP MODULE'S CONNECTORS, AS EYE DAMAGE MAY RESULT.



The SFP module is sensitive to electrostatic discharge (ESD). It is recommended that you use an ESD-preventive wrist strap grounded to the Densité chassis while handling the SFP module.



SFP modules are subject to wear, and their useful lifetime is reduced each time they are inserted or removed. Do not remove them more often than is absolutely necessary.



Never remove or install an SFP module with the fiber optic cables connected. Damage to the cables could result.



The presence of dust and debris can seriously degrade the performance of an optical interface. It is recommended that you insert a dust plug into the SFP module whenever a fiber optic cable is not connected.

Installing an SFP module

1. Make sure that the bale clasp lever is in the closed position
2. Position the SFP module so that the recessed slot is lined up with the tab side of the socket.

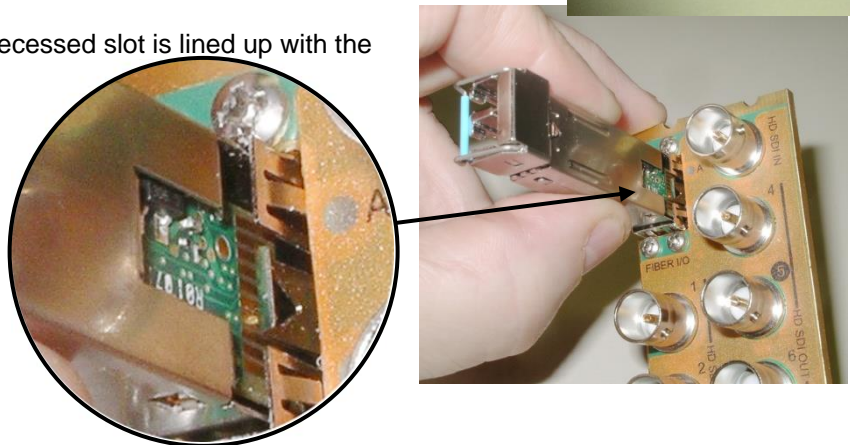
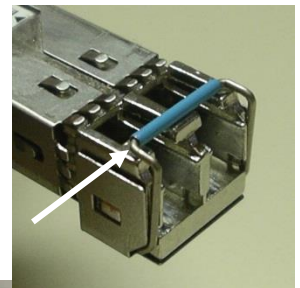

3. Slide the module straight into the socket, and push gently until it clicks into position.

Connecting the fiber optic cables

1. Remove the dust plug from the SFP module if present
2. Verify that the exposed end of the optical fiber in the LC connector is clean
 - Carefully remove any debris if necessary.
3. Plug the LC-terminated fiber optic cable into the SFP module

Removing the fiber optic cables

1. Grasp the LC fiber optic connector that is plugged into the SFP module, and pull it straight out to disengage the optical fiber from the SFP.
 - Never pull the fiber optic cable itself, as catastrophic damage may occur.
2. Insert a dust plug into the SFP module.

Removing the SFP module

1. Move the bale clasp lever to the open position.
2. Grasp the SFP module between your thumb and forefinger, and pull it straight out of the slot.
 - Do NOT pull on the bale clasp lever to remove the module, as it is easily damaged
 - You may find that you need to wiggle the module, or perhaps push it into the slot a bit, before it will release and slide out.
3. Insert a dust plug into the SFP module.

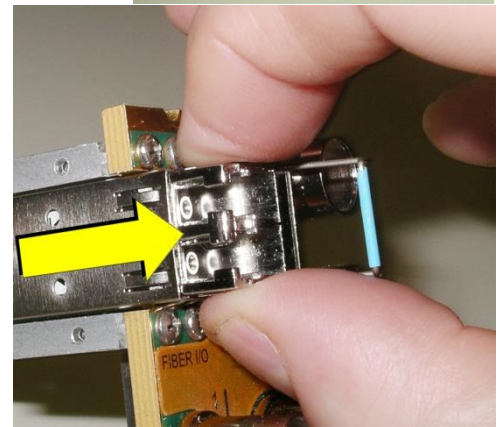
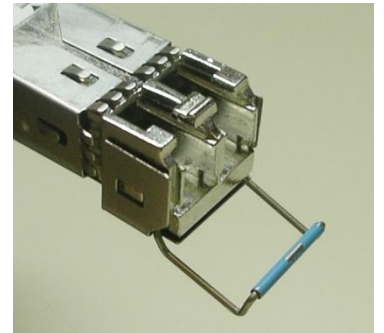
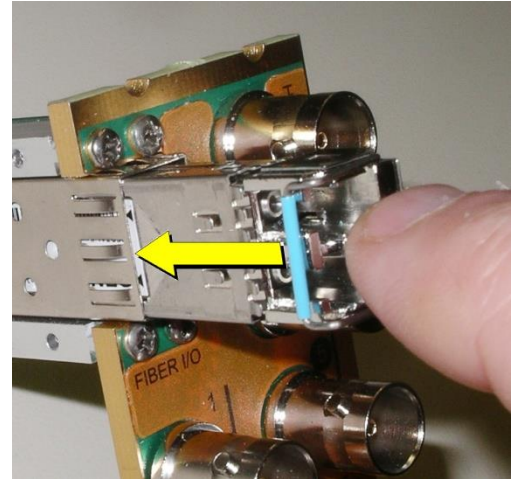

APPENDIX C: BBC HLG Look-Up Table

Introduction

To facilitate the introduction of HLG production, the XIP-3901-UDC-HDR option now includes the BBC R&D look-up tables (LUTs) release v1.4 which implement a range of key format conversions. The conversions are 33-cube 3D-LUTs including:

- BT.2100 PQ (1000 cd/m² nominal peak) to BT.2100 HLG
- BT.2100 PQ (4000 cd/m² nominal peak) to BT.2100 HLG
- BT.709 (SDR) to BT.2100 HLG (display-referred direct mapping maintaining SDR "look")
- BT.709 (SDR) to BT.2100 HLG (scene-referred direct mapping for matching cameras)
- BT.709 (SDR) to BT.2100 HLG (display-referred "up-mapping"/ "inverse tone mapping" to maintain SDR artistic intent)
- BT.709 (SDR) to BT.2100 HLG (scene-referred "up-mapping"/ "inverse tone mapping" for matching SDR and HDR cameras)
- BT.2100 HLG to BT.2100 PQ (1000 cd/m² nominal peak)
- BT.2100 HLG to BT.709 (SDR) (display-referred "down-mapping"/ "tone mapping" maintaining HDR "look")
- BT.2100 HLG to BT.709 (SDR) (scene-referred "down-mapping"/ "tone mapping" to match SDR cameras)
- S-Log3 SR-Live (BT.2020 color) to BT.2100 HLG (scene-referred conversion to match BT.2100 HLG cameras)

The scene-light LUTs will only work correctly with ITU-R BT.2100 signals. They will not color match cameras configured for Sony's "HLG Live" variant, nor the "Traditional Color" variant of HLG specified in ITU-R report BT.2390, described as "HLG Vivid" in Canon cameras.

LUT Details

Of the various licensed LUT from the BBC, the XIP-3901 will use Type II LUTs that are intended for full-range SDI input signals such as S-Log3 and those produced by some PQ devices and Type III LUTs are intended for LUT devices that process narrow-range video signals, but which operate over the full 10-bit signal range (0 to 1023). They will therefore pass sub-blacks (signals below 10-bit code value 64) and super-whites (signals above 10-bit code value 940) (required for ITU-R BT.814 HDR PLUGE and ITU-R BT.2111 HDR Color Bars), so are most suitable for broadcast TV applications.

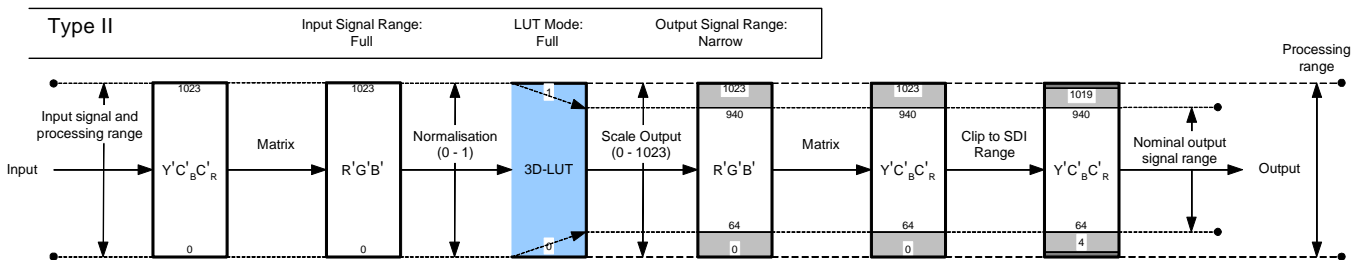

Figure 107 – Type II signal scaling, intended for full-range input signals (for example, S-Log3)

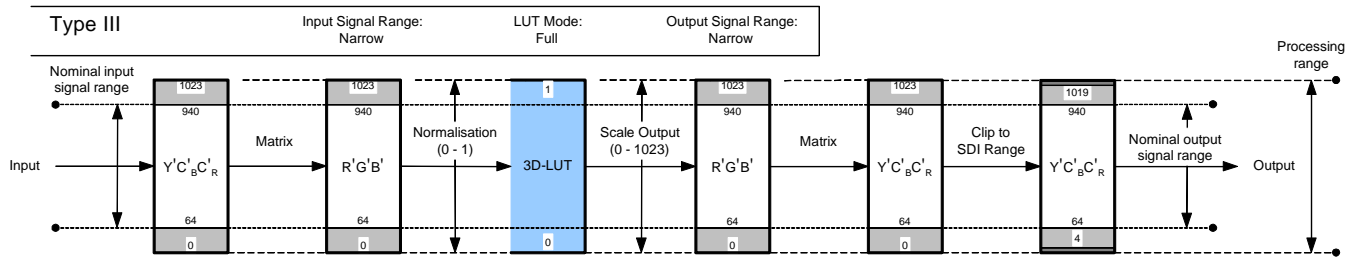

Figure 108 – Type III signal scaling, primarily intended for hardware-based LUT applications

The Type II “full-range mode” LUT is used to convert full-range PQ and S-Log3 signals to HLG. So full-range Type II versions of the PQ1000, PQ4000, S-Log3 (100%) and S-Log3 (200%) conversion LUTs are provided.

We recommended only using narrow-range signals with HLG, to improve interoperability, maintain signal fidelity and reduce the likelihood of errors in production. So even when a hardware LUT device is operated in full-range mode, the HLG output signal is always offset and scaled within the full-range “container”, to lie within the usual narrow signal range of 64 to 940 (10-bits).

Scene-Light versus Display-Light Conversions

Most SDR/HDR format conversions are based on “display-light”. By that we mean that the conversion calculates the light produced by the original signal on a reference display operating in the original format, and attempts to produce a similar light output on a reference display operating in the new output format. Display-light conversions are designed to preserve the artistic intent of the pictures after conversion. So display-light conversions work well for graded content. An example of a display-light conversion for BT.709 to BT.2100 HLG is shown in the Figure below.

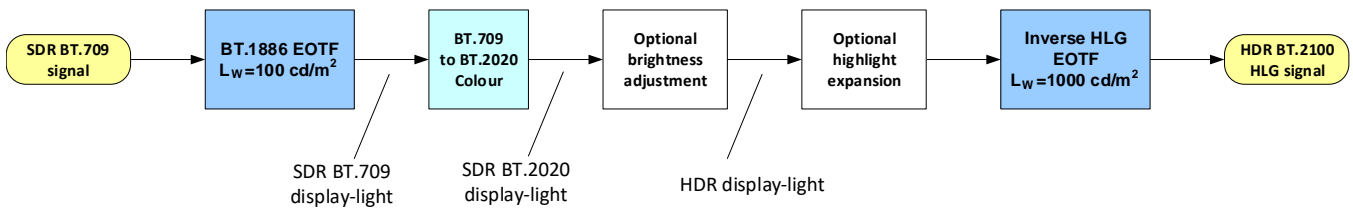

Figure 109 – SDR to HDR Display-Light Conversion

For live production, however, it is usually more important to color match signals produced in different formats – for example a native BT.2100 HLG camera with an SDR BT.709 super slo-mo camera. However, as the native displayed “look” of the SDR BT.709, SDR BT.2020, BT.2100 HLG, BT.2100 PQ and S-Log3 (SR-Live) production formats are all different (in terms of color and tone reproduction), color matching of cameras will be difficult using display-light conversions. Instead, a scene-light conversion should be used.

A scene-light conversion first calculates the light falling on the camera sensor by applying an inverse OETF, then any color space conversion and highlight expansion, and finally derives the output signal by applying the output format’s OETF. As the light falling on the camera sensor is the same regardless of production format, a more exact color and tone match is obtained than through display-light conversion. An example of a scene-light conversion for BT.709 to BT.2100 HLG is shown in the Figure below.

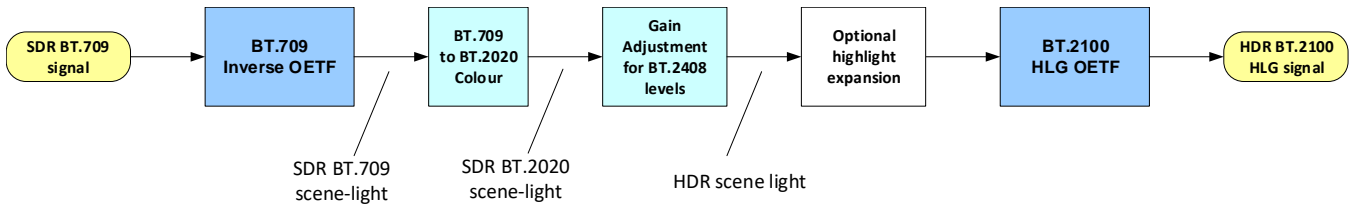

Figure 110 – Scene-light SDR to HDR conversion

Scene-light conversions are also useful for HDR to SDR conversion, where the desire is to match the “look” of a traditional SDR camera. For example, the LUT 12 (scene-light conversion from BT.2100 HLG to SDR BT.709) should be used when a BT.2100 HLG production is required to provide an SDR BT.709 output that closely resembles the “look” of a traditional SDR BT.709 camera; perhaps for intercutting with SDR BT.709 cameras covering the same event in SDR.

More details can be found in section 7.1.3 of ITU-R report BT.2408, “Guidance for Operational Practices in HDR Television Production”.

Table 1 illustrates the recommended conversions for a range of different signal types and applications.

Table 1 – Recommended Conversions and LUTs

	BBC LUT	Conversion Type		SDR to HDR		HDR to SDR	HDR to HDR
		Scene-Light	Display -Light	Direct Mapping	Up-Mapping	Down-Mapping	Trans-code
Graded Content	SDR graded inserts	5	✓		✓		
	SDR graded programs	3		✓			
	HLG graded content	8				✓	
	PQ graded content	1 or 2		✓			✓
Camera to switcher	SDR BT.709 camera	6	✓		✓		
	S-Log3 camera	10	✓				✓
	"S-Log3 Live" camera	11	✓				✓
Camera to SDR shading	HDR only camera	8 or 12	✓	✓		✓	
Graphics	SDR matching color branding	3		✓			
	SDR matching in-vision signage	4	✓		✓		
Program Output	SDR complete program	8		✓		✓	
	SDR "Clean Feed" for mixing with unilateral and ISO SDR cameras	12	✓			✓	
	PQ for onward distribution	7		✓			✓

Extending the SDR Color Gamut

When matching SDR BT.709 cameras with BT.2100 HLG cameras, significantly better results can be obtained if the signal clippers on the SDR cameras are relaxed to EBU Technical Recommendation R103 signal levels (-5%/+105%) and the conversion process takes account of the signals in the sub-blacks and super-whites. The sub-black and super-white signals produced by many cameras effectively increase the dynamic range and color gamut of the camera. More details can be found in ITU-R report BT.2250.

In order to exploit the extended SDR signal range, the conversion LUT has to operate in “full-range” mode, taking account of the black level offset of the SDR input signals (10-bit code value 64) (LUT Type III). Because of the improved performance, the scene-referred BT.709 to BT.2100 HLG direct mapping LUT (LUT 4) and up-mapping LUTs (LUT 6-1 and 6-2), are only provided in full-range mode (Type III) versions.

Output Signal Clipping

Type III LUTs with SDR BT.709 outputs are clipped within the look-up table to EBU Technical Recommendation R103 signal levels. In territories with stricter limits on the SDR signal range, an additional hardware legalizer may be needed.

The remaining Type II and Type III LUTs with PQ or HLG outputs are clipped to full-range, to ensure that they pass ITU-R BT.2111 HDR Color Bars. External processing, illustrated in Figure 107 and Figure 108, is necessary to clip the LUT output to 10-bit SDI range (4 to 1019).

Table 2 – LUT Conversions and variant table

LUT Conversion	Description
SDR to HLG Scene (4-1a - v1.4)	For use with SDR cameras that approximate the BT.709 OETF with a square root BT.709 signals are directly mapped into BT.2100 HLG at the BT.2408 signal levels using a scene-light (scene-referred) conversion. The “look” of the original BT.709 content is changed to match native BT.2100 HLG cameras. 100% SDR signal is mapped to 75% HLG (HDR Reference White).
SDR to HLG Scene Strict (4-2a - v1.4)	For use with SDR cameras that implement a strict BT.709 OETF BT.709 signals are directly mapped into BT.2100 HLG at the BT.2408 signal levels using a scene-light (scene-referred) conversion. The “look” of the original BT.709 content is changed to match native BT.2100 HLG cameras. 100% SDR signal is mapped to 75% HLG (HDR Reference White). NOTE: Unlike BT.2100 HLG, SDR cameras that implement a strict BT.709 OETF tend to crush detail in the shadows of a scene. That detail will become more visible after applying this conversion.
SDR to HLG Scene Upmap (6-1a - v1.4)	For use with SDR cameras that approximate the BT.709 OETF with a square root. BT.709 signals are inverse tone mapped (up-converted) to BT.2100 HLG using a scene-light (scene-referred) conversion. The “look” of the original BT.709 content is changed to match native BT.2100 HLG cameras. Whilst the ITU-R BT.2408 signal levels are taken into account, a small boost is applied to the SDR highlights to better match natively produced HDR content. 100% SDR signal is inverse tone mapped to 79% HLG. 105% SDR signals (EBU R.103 signal levels) are inverse tone-mapped to 83% HLG.
SDR to HLG Scene Upmap Strict (6-2a - v1.4)	For use with SDR cameras that implement a strict BT.709 OETF BT.709 signals are inverse tone mapped (up-converted) to BT.2100 HLG using a scene-light (scene-referred) conversion. The “look” of the original BT.709 content is changed to match native BT.2100 HLG cameras. Whilst the ITU-R BT.2408 signal levels are taken into account, a small boost is applied to the SDR highlights to better match natively produced HDR content. 100% SDR signal is inverse tone mapped to 79% HLG. 105% SDR signals (EBU R.103 signal levels) are inverse tone-mapped to 83% HLG. NOTE: Unlike BT.2100 HLG, SDR cameras that implement a strict BT.709 OETF tend to crush detail in the shadows of a scene. That detail will become more visible after applying this conversion.

LUT Conversion	Description
SDR to HLG Display (3c - v1.4)	Display-referred direct mapping maintaining SDR "look". 100% SDR maps to 75 % HLG (HDR Reference White - see ITU-R BT.2408 and BT.2390). Recommended for matching the displayed color of SDR graphics.
SDR to HLG Display Upmap (5c - v1.4)	BT.709 signals are inverse tone mapped (up-converted) to BT.2100 HLG using a display-light (display-referred) conversion. This LUT is designed to complement LUT 8 (BT.2100 HLG to BT.709 tone mapping - display-light) to reduce round-tripping losses (SDR to HDR to SDR conversion). Whilst the ITU-R BT.2408 signal levels are taken into account, a modest boost is applied to the SDR highlights to better match natively produced HDR content. The LUT, however, attempts to preserve the artistic intent of the original BT.709 content. 100% SDR signal is inverse tone mapped to 83% HLG.
HLG to SDR Scene (12-1c - v1.4)	For use with SDR cameras that approximate the BT.709 OETF with a square root BT.2100 HLG signals are tone mapped (down-converted) to BT.709 using a scene-light (scene-referred) conversion. The "look" of the original BT.2100 HLG content is changed to match native BT.709 cameras with a square root approximation of the BT.709 OETF. This LUT is the exact inverse of LUT 6-1 (BT.709 to BT.2100 HLG inverse tone mapping - scene-light) to minimize round-tripping losses (SDR to HDR to SDR conversion). HDR Reference White (75% HLG) is tone mapped to 95% BT.709, allowing for some soft clipping of highlights. 79% HLG signal is tone mapped to 100% BT.709. For sub-blacks and super-whites, the LUT outputs are clipped to EBU R.103 signal levels.
HLG to SDR Scene Strict (12-2c - v1.4)	For use with SDR cameras that implement a strict BT.709 OETF BT.2100 HLG signals are tone mapped (down-converted) to BT.709 using a scene-light (scene-referred) conversion. The "look" of the original BT.2100 HLG content is changed to match native BT.709 cameras with a strict implementation of the BT.709 OETF. This LUT is the exact inverse of LUT6-2 (BT.709 to BT.2100 HLG inverse tone mapping - scene-light) to minimize round-tripping losses (SDR to HDR to SDR conversion). HDR Reference White (75% HLG) is tone mapped to 95% BT.709, allowing for some soft clipping of highlights. 79% HLG signal is tone mapped to 100% BT.709. For sub-blacks and super-whites, the LUT outputs are clipped to EBU R.103 signal levels. NOTE: Unlike BT.2100 HLG, SDR cameras that implement a strict BT.709 OETF tend to crush detail in the shadows of a scene. So shadow detail visible in the HDR image will become less visible after applying this conversion
HLG to SDR Display (8c - v1.4)	BT.2100 HLG signals are tone mapped (down-converted) to BT.709 using a display-light (display-referred) conversion. The LUT, therefore, attempts to preserve the artistic intent of the original HLG content, when converting to SDR. This LUT is designed to complement LUT 5 (BT.709 to BT.2100 HLG inverse tone mapping - display-light) to reduce round-tripping losses (SDR to HDR to SDR conversion). HDR Reference White (75% HLG) is tone mapped to 86% BT.709, allowing signal headroom for compressed highlights. 100% HLG signal is tone mapped to 100% BT.709. For sub-blacks and super-whites, the HLG super-white signals are tone-mapped to SDR super-white signals. The LUT outputs are clipped to EBU R.103 signal levels. In version 1.4, the LUT is brighter to correctly map the BT.709 equivalent color bars within the up-coming "EBU HDR Line-Up Bars" to 75% BT.709. There are also color saturation improvements over the v1.3.1 release

LUT Conversion	Description
HLG to SDR Display Harsh (9c - v1.4)	<p>HDR-graded content and live programs with graphics - BT.2100 HLG to BT.709, downmapping (display-light) using SDR “super-whites”</p> <p>BT.2100 HLG signals are down-mapped (tone-mapped) to BT.709 using a display-light conversion. Colors and the appearance of mid-tones and lowlights are maintained after conversion. The LUT, therefore, attempts to preserve the artistic intent of the original HLG content.</p> <p>“HDR Reference White” (75% HLG) is mapped to 95% BT.709 and HDR highlights extend into the SDR super-white region; for that reason, only “Full-Range Mode” Type III LUTs are made available. 94% HLG signal is mapped to the EBU R103 preferred maximum of 105% BT.709. HLG signals above 94% are clipped.</p> <p>This LUT is recommended for use in scenarios where minimizing SDR>HDR>SDR “round-trip” losses is of the utmost importance. Minimal round-trip losses are achieved when used with the display-light up-mapping LUT5. Better overall results are, however, usually achieved with the LUT8 down-mapper, which does not rely on the SDR super-white signal ranges being maintained through the program delivery and distribution chains.</p>
PQ 1000 Nits Full Range to HLG (1c - v1.4)	<p>BT.2100 PQ signals are converted to BT.2100 HLG at the 1000 cd/m² “bridge” condition, so that 1000 cd/m² PQ maps to 100% HLG. See ITU-R report BT.2390 Section 7.2. PQ signals above 1000 cd/m² are mapped into the HLG “super-white” signal range up to a maximum of 1810 cd/m², corresponding to 109% HLG (10-bit code value 1019).</p>
PQ 1000 Nits Narrow Range to HLG (1e - v1.4)	<p>BT.2100 PQ signals are converted to BT.2100 HLG at the 1000 cd/m² “bridge” condition, so that 1000 cd/m² PQ maps to 100% HLG. See ITU-R report BT.2390 Section 7.2.</p>
PQ 4000 Nits Full Range to HLG (2c - v1.4)	<p>4000 cd/m² BT.2100 PQ signals are converted to BT.2100 HLG by first tone mapping to the 1000 cd/m² “bridge” condition, and then converting to HLG. The tone mapping is applied on the luminance component to avoid hue distortions. 4000 cd/m² PQ maps to 100% HLG. See ITU-R report BT.2390 Section 7.4</p>
PQ 4000 Nits Narrow Range to HLG (2e - v1.4)	<p>4000 cd/m² BT.2100 PQ signals are converted to BT.2100 HLG by first tone mapping to the 1000 cd/m² “bridge” condition, and then converting to HLG. The tone mapping is applied on the luminance component to avoid hue distortions. 4000 cd/m² PQ maps to 100% HLG. See ITU-R report BT.2390 Section 7.4. PQ signals above 4000 cd/m² are mapped into the HLG “super-white” signal range.</p>
HLG to PQ 1000 Nits Narrow range (7c - v1.4)	<p>BT.2100 HLG signals are converted to BT.2100 PQ at the 1000 cd/m² “bridge” condition, so that 100% HLG maps to 1000 cd/m² PQ. See ITU-R report BT.2390 Section 7.2. HLG signals above 100% are mapped to PQ signals greater than 1000 cd/m², up to a maximum of 1810 cd/m², corresponding to 109% HLG (10-bit code value 1019).</p>
SLog3 100% Scene to HLG (10a - v1.4)	<p>S-Log3 signals produced using the Sony’s “100 %” workflow (for example, 100% IRE input equals 90% reflectance) are converted to BT.2100 HLG with ITU-R BT.2408 signal levels. Thus a 100% IRE input signal (90% reflectance) maps to 73% HLG. A scene-light conversion is used, so that the converted S-Log3 signal matches the “look” of BT.2100 HLG cameras.</p>
SLog3 200% Scene to HLG (11a - v1.4)	<p>S-Log3 signals produced using the Sony’s “200 %” workflow (for example, 200% IRE input equals 90% reflectance) are converted to BT.2100 HLG with ITU-R BT.2408 signal levels. Thus a 200% IRE input signal (90% reflectance) maps to 73% HLG. 200% workflows are common for “S-Log3 Live” productions. A scene-light conversion is used, so that the converted S-Log3 signal matches the “look” of BT.2100 HLG cameras.</p>
Unity	Pass-through LUT