

IPVU

COMPACT IP MONITORING GATEWAY

Installation Guide

13-03068-010-M00 AD

2021-07-15

FCC Compliance

In order to comply with FCC/CFR47: Part 15 regulations, it is necessary to use high-quality, triple-screened Media or Monitor cable assemblies with integrated ferrite suppression at both ends.

Patent Information

This product may be protected by one or more patents.

For further information, please visit: www.grassvalley.com/patents/

Copyright and Trademark Notice

Grass Valley[®], GV[®] and the Grass Valley logo and/or any of the Grass Valley products listed in this document are trademarks or registered trademarks of GVBB Holdings SARL, Grass Valley USA, LLC, or one of its affiliates or subsidiaries. All other intellectual property rights are owned by GVBB Holdings SARL, Grass Valley USA, LLC, or one of its affiliates or subsidiaries. All third party intellectual property rights (including logos or icons) remain the property of their respective owners.

Copyright © 2019 - 2021-07-15 GVBB Holdings SARL and Grass Valley USA, LLC. All rights reserved.

Specifications are subject to change without notice.

Terms and Conditions

Please read the following terms and conditions carefully. By using documentation, you agree to the following terms and conditions.

Grass Valley hereby grants permission and license to owners of to use their product manuals for their own internal business use. Manuals for Grass Valley products may not be reproduced or transmitted in any form or by any means, electronic or mechanical, including photocopying and recording, for any purpose unless specifically authorized in writing by Grass Valley.

A Grass Valley manual may have been revised to reflect changes made to the product during its manufacturing life. Thus, different versions of a manual may exist for any given product. Care should be taken to ensure that one obtains the proper manual version for a specific product serial number.

Information in this document is subject to change without notice and does not represent a commitment on the part of Grass Valley.

Warranty information is available from the Legal Terms and Conditions section of Grass Valley's website (www.grassvalley.com).

Title	IPVU Installation Guide
Part Number	13-03068-010-M00 AD
Revision	2021-07-15, 13:10

Important Safety Information

This section provides important safety guidelines for operators and service personnel. Specific warnings and cautions appear throughout the manual where they apply. Please read and follow this important information, especially those instructions related to the risk of electric shock or injury to persons.

Symbols and Their Meanings



Indicates that dangerous high voltage is present within the equipment enclosure that may be of sufficient magnitude to constitute a risk of electric shock.



Indicates that the user, operator or service technician should refer to the product manuals for important operating, maintenance, or service instructions.



This is a prompt to note the fuse rating when replacing fuses. The fuse referenced in the text must be replaced with one having the ratings indicated.



Identifies a protective grounding terminal which must be connected to earth ground prior to making any other equipment connections.



Identifies an external protective grounding terminal which may be connected to earth ground as a supplement to an internal grounding terminal.



Indicates that static sensitive components are present, which may be damaged by electrostatic discharge. Use anti-static procedures, equipment and surfaces during servicing.



Indicates that the equipment has more than one power supply cord, and that all power supply cords must be disconnected before servicing to avoid electric shock.



The presence of this symbol in or on Grass Valley equipment means that it has been tested and certified as complying with applicable Underwriters Laboratory (UL) regulations and recommendations for USA.



The presence of this symbol in or on Grass Valley equipment means that it has been tested and certified as complying with applicable Canadian Standard Association (CSA) regulations and recommendations for USA/Canada.



The presence of this symbol in or on Grass Valley equipment means that it has been tested and certified as complying with applicable Underwriters Laboratory (UL) regulations and recommendations for USA/Canada.



The presence of this symbol in or on Grass Valley equipment means that it has been tested and certified as complying with applicable Intertek Testing Services regulations and recommendations for USA/Canada.



The presence of this symbol in or on Grass Valley product means that it complies with all applicable European Union (CE) directives.



The presence of this symbol in or on Grass Valley product means that it complies with safety of laser product applicable standards.

Warnings



A warning indicates a possible hazard to personnel, which may cause injury or death. Observe the following general warnings when using or working on this equipment:

- Appropriately listed/certified mains supply power cords must be used for the connection of the equipment to the rated mains voltage.
- This product relies on the building's installation for short-circuit (over-current) protection. Ensure that a fuse or circuit breaker for the rated mains voltage is used on the phase conductors.
- Any instructions in this manual that require opening the equipment cover or enclosure are for use by qualified service personnel only.
- Do not operate the equipment in wet or damp conditions.
- This equipment is grounded through the grounding conductor of the power cords. To avoid electrical shock, plug the power cords into a properly wired receptacle before connecting the equipment inputs or outputs.
- Route power cords and other cables so they are not likely to be damaged. Properly support heavy cable bundles to avoid connector damage.
- Disconnect power before cleaning the equipment. Do not use liquid or aerosol cleaners; use only a damp cloth.
- Dangerous voltages may exist at several points in this equipment. To avoid injury, do not touch exposed connections and components while power is on.
- High leakage current may be present. Earth connection of product is essential before connecting power.
- Prior to servicing, remove jewelry such as rings, watches, and other metallic objects.
- To avoid fire hazard, use only the fuse type and rating specified in the service instructions for this product, or on the equipment.
- To avoid explosion, do not operate this equipment in an explosive atmosphere.
- Use proper lift points. Do not use door latches to lift or move equipment.
- Avoid mechanical hazards. Allow all rotating devices to come to a stop before servicing.
- Have qualified service personnel perform safety checks after any service.

Cautions



A caution indicates a possible hazard to equipment that could result in equipment damage. Observe the following cautions when operating or working on this equipment:

- This equipment is meant to be installed in a restricted access location.
- When installing this equipment, do not attach the power cord to building surfaces.
- Products that have no on/off switch, and use an external power supply must be installed in proximity to a main power outlet that is easily accessible.
- Use the correct voltage setting. If this product lacks auto-ranging power supplies, before applying power ensure that each power supply is set to match the power source.
- Provide proper ventilation. To prevent product overheating, provide equipment ventilation in accordance with the installation instructions.
- Do not operate with suspected equipment failure. If you suspect product damage or equipment failure, have the equipment inspected by qualified service personnel.
- To reduce the risk of electric shock, do not perform any servicing other than that contained in the operating instructions unless you are qualified to do so. Refer all servicing to qualified service personnel.
- This unit may have more than one power supply cord. Disconnect all power supply cords before servicing to avoid electric shock.
- Follow static precautions at all times when handling this equipment. Servicing should be done in a static-free environment.
- To reduce the risk of electric shock, plug each power supply cord into separate branch circuits employing separate service grounds.

Electrostatic Discharge (ESD) Protection



Electrostatic discharge occurs when electronic components are improperly handled and can result in intermittent failure or complete damage adversely affecting an electrical circuit. When you remove and replace any card from a frame always follow ESD-prevention procedures:

- Ensure that the frame is electrically connected to earth ground through the power cord or any other means if available.
- Wear an ESD wrist strap ensuring that it makes good skin contact. Connect the grounding clip to an *unpainted surface* of the chassis frame to safely ground unwanted ESD voltages. If no wrist strap is available, ground yourself by touching the *unpainted* metal part of the chassis.
- For safety, periodically check the resistance value of the antistatic strap, which should be between 1 and 10 megohms.
- When temporarily storing a card make sure it is placed in an ESD bag.
- Cards in an earth grounded metal frame or casing do not require any special ESD protection.

Mesures de sécurité et avis importants

La présente section fournit des consignes de sécurité importantes pour les opérateurs et le personnel de service. Des avertissements ou mises en garde spécifiques figurent dans le manuel, dans les sections où ils s'appliquent. Prenez le temps de bien lire les consignes et assurez-vous de les respecter, en particulier celles qui sont destinées à prévenir les décharges électriques ou les blessures.

Signification des symboles utilisés



Signale la présence d'une tension élevée et dangereuse dans le boîtier de l'équipement ; cette tension peut être suffisante pour constituer un risque de décharge électrique.



Avertit l'utilisateur, l'opérateur ou le technicien de maintenance que des instructions importantes relatives à l'utilisation et à l'entretien se trouvent dans la documentation accompagnant l'équipement.



Invite l'utilisateur, l'opérateur ou le technicien de maintenance à prendre note du calibre du fusible lors du remplacement de ce dernier. Le fusible auquel il est fait référence dans le texte doit être remplacé par un fusible du même calibre.



Identifie une borne de mise à la terre de protection. Il faut relier cette borne à la terre avant d'effectuer toute autre connexion à l'équipement.



Identifie une borne de mise à la terre externe qui peut être connectée en tant que borne de mise à la terre supplémentaire.



Signale la présence de composants sensibles à l'électricité statique et qui sont susceptibles d'être endommagés par une décharge électrostatique. Utilisez des procédures, des équipements et des surfaces antistatiques durant les interventions d'entretien.



Le symbole ci-contre signifie que l'appareil comporte plus d'un cordon d'alimentation et qu'il faut débrancher tous les cordons d'alimentation avant toute opération d'entretien, afin de prévenir les chocs électriques.



La marque UL certifie que l'appareil visé a été testé par Underwriters Laboratory (UL) et reconnu conforme aux exigences applicables en matière de sécurité électrique en vigueur au Canada et aux États-Unis.



La marque C-CSA-US certifie que l'appareil visé a été testé par l'Association canadienne de normalisation (CSA) et reconnu conforme aux exigences applicables en matière de sécurité électrique en vigueur au Canada et aux États-Unis.



La marque C-UL-US certifie que l'appareil visé a été testé par Underwriters Laboratory (UL) et reconnu conforme aux exigences applicables en matière de sécurité électrique en vigueur au Canada et aux États-Unis.



La marque ETL Listed d'Intertek pour le marché Nord-Américain certifie que l'appareil visé a été testé par Intertek et reconnu conforme aux exigences applicables en matière de sécurité électrique en vigueur au Canada et aux États-Unis.



Le marquage CE indique que l'appareil visé est conforme aux exigences essentielles des directives applicables de l'Union européenne en matière de sécurité électrique, de compatibilité électromagnétique et de conformité environnementale.



Le symbole ci-contre sur un appareil Grass Valley ou à l'intérieur de l'appareil indique qu'il est conforme aux normes applicables en matière de sécurité laser.

Avertissements



Les avertissements signalent des conditions ou des pratiques susceptibles d'occasionner des blessures graves, voire fatales. Veuillez vous familiariser avec les avertissements d'ordre général ci-dessous :

- Un cordon d'alimentation dûment homologué doit être utilisé pour connecter l'appareil à une tension de secteur de 120 V CA ou 240 V CA.
- La protection de ce produit contre les courts-circuits (surintensités) dépend de l'installation électrique du bâtiment. Assurez-vous qu'un fusible ou un disjoncteur pour 120 V CA ou 240 V CA est utilisé sur les conducteurs de phase.
- Dans le présent manuel, toutes les instructions qui nécessitent d'ouvrir le couvercle de l'équipement sont destinées exclusivement au personnel technique qualifié.
- N'utilisez pas cet appareil dans un environnement humide.
- Cet équipement est mis à la terre par le conducteur de mise à la terre des cordons d'alimentation. Pour éviter les chocs électriques, branchez les cordons d'alimentation sur une prise correctement câblée avant de brancher les entrées et sorties de l'équipement.
- Acheminez les cordons d'alimentation et autres câbles de façon à ce qu'ils ne risquent pas d'être endommagés. Supportez correctement les enroulements de câbles afin de ne pas endommager les connecteurs.
- Coupez l'alimentation avant de nettoyer l'équipement. Ne pas utiliser de nettoyeurs liquides ou en aérosol. Utilisez uniquement un chiffon humide.
- Des tensions dangereuses peuvent exister en plusieurs points dans cet équipement. Pour éviter toute blessure, ne touchez pas aux connexions ou aux composants exposés lorsque l'appareil est sous tension.
- Avant de procéder à toute opération d'entretien ou de dépannage, enlevez tous vos bijoux (notamment vos bagues, votre montre et autres objets métalliques).
- Pour éviter tout risque d'incendie, utilisez uniquement les fusibles du type et du calibre indiqués sur l'équipement ou dans la documentation qui l'accompagne.

- Ne pas utiliser cet appareil dans une atmosphère explosive.
- Présence possible de courants de fuite. Un raccordement à la masse est indispensable avant la mise sous tension.
- Après tout travail d'entretien ou de réparation, faites effectuer des contrôles de sécurité par le personnel technique qualifié.

Mises en garde



Les mises en garde signalent des conditions ou des pratiques susceptibles d'endommager l'équipement. Veuillez vous familiariser avec les mises en garde ci-dessous :

- L'appareil est conçu pour être installé dans un endroit à accès restreint.
- Au moment d'installer l'équipement, ne fixez pas les cordons d'alimentation aux surfaces intérieures de l'édifice.
- Les produits qui n'ont pas d'interrupteur marche-arrêt et qui disposent d'une source d'alimentation externe doivent être installés à proximité d'une prise de courant facile d'accès.
- Si l'équipement n'est pas pourvu d'un modules d'alimentation auto-adaptables, vérifiez la configuration de chacun des modules d'alimentation avant de les mettre sous tension.
- Assurez une ventilation adéquate. Pour éviter toute surchauffe du produit, assurez une ventilation de l'équipement conformément aux instructions d'installation.
- N'utilisez pas l'équipement si vous suspectez un dysfonctionnement du produit. Faites-le inspecter par un technicien qualifié.
- Pour réduire le risque de choc électrique, n'effectuez pas de réparations autres que celles qui sont décrites dans le présent manuel, sauf si vous êtes qualifié pour le faire. Confiez les réparations à un technicien qualifié. La maintenance doit se réaliser dans un milieu libre d'électricité statique.
- L'appareil peut comporter plus d'un cordon d'alimentation. Afin de prévenir les chocs électriques, débrancher tous les cordons d'alimentation avant toute opération d'entretien.
- Veillez à toujours prendre les mesures de protection antistatique appropriées quand vous manipulez l'équipement.
- Pour réduire le risque de choc électrique, branchez chaque cordon d'alimentation dans des circuits de dérivation distincts utilisant des zones de service distinctes.

Protection contre les décharges électrostatiques (DES)



Une décharge électrostatique peut se produire lorsque des composants électroniques ne sont pas manipulés de manière adéquate, ce qui peut entraîner des défaillances intermittentes ou endommager irrémédiablement un circuit électrique. Au moment de remplacer une carte dans un châssis, prenez toujours les mesures de protection antistatique appropriées :

- Assurez-vous que le châssis est relié électriquement à la terre par le cordon d'alimentation ou tout autre moyen disponible.

- Portez un bracelet antistatique et assurez-vous qu'il est bien en contact avec la peau. Connectez la pince de masse à une *surface non peinte* du châssis pour détourner à la terre toute tension électrostatique indésirable. En l'absence de bracelet antistatique, déchargez l'électricité statique de votre corps en touchant une surface métallique *non peinte* du châssis.
- Pour plus de sécurité, vérifiez périodiquement la valeur de résistance du bracelet antistatique. Elle doit se situer entre 1 et 10 mégohms.
- Si vous devez mettre une carte de côté, assurez-vous de la ranger dans un sac protecteur antistatique.
- Les cartes qui sont reliées à un châssis ou boîtier métallique mis à la terre ne nécessitent pas de protection antistatique spéciale.

Environmental Information

European (CE) WEEE directive.



This symbol on the product(s) means that at the end of life disposal it should not be mixed with general waste.

Visit www.grassvalley.com for recycling information.

Grass Valley believes this environmental information to be correct but cannot guarantee its completeness or accuracy since it is based on data received from sources outside our company. All specifications are subject to change without notice.

If you have questions about Grass Valley environmental and social involvement (WEEE, RoHS, REACH, etc.), please contact us at environment@grassvalley.com.

Laser Safety - Fiber Output SFP and QSFP Modules Warning

LASER SAFETY



The average optical output power does not exceed 0 dBm (1mW) under normal operating conditions. Unused optical outputs should be covered to prevent direct exposure to the laser beam.

Even though the power of these lasers is low, the beam should be treated with caution and common sense because it is intense and concentrated. Laser radiation can cause irreversible and permanent damage of eyesight. Please read the following guidelines carefully:

- Make sure that a fiber is connected to the board's fiber outputs before power is applied. If a fiber cable (e.g. patchcord) is already connected to an output, make sure that the cable's other end is connected, too, before powering up the board.
- **Do not** look in the end of a fiber to see if light is coming out. The laser wavelengths being used are totally invisible to the human eye and can cause permanent damage. Always use optical instrumentation, such as an optical power meter, to verify light output.

Mains Supply Voltage

Before connecting the equipment, observe the safety warnings section and ensure that the local mains supply is within the rating stated on the rear of the equipment.

Safety and EMC Standards

This equipment complies with the following standards:

Safety Standards



Information Technology Equipment - Safety Part 1

EN60950-1: 2006

Safety of Information Technology Equipment Including Electrical Business Equipment.

UL1419 (4th Edition)

Standard for Safety – Professional Video and Audio equipment (UL file number E193966)

EMC Standards

This unit conforms to the following standards:

EN55032:2015 (Class A)

Electromagnetic Compatibility of multimedia equipment - Emission requirements

EN61000-3-2:2014 (Class A)

Electromagnetic Compatibility - Limits for harmonic current emissions

EN61000-3-3:2013

Electromagnetic Compatibility - Limits of voltage changes, voltage fluctuations and flicker

EN55103-2:2009 (Environment E2)

Electromagnetic Compatibility, Product family standard for audio, video, audio-visual and entertainment lighting control apparatus for professional use. Part 2. Immunity

WARNING

This equipment is compliant with Class A of CISPR 32. In a residential environment this equipment may cause radio interference.

FCC / CFR 47:Part 15 (Class A)

Federal Communications Commission Rules Part 15, Subpart B

Caution to the user that changes or modifications not expressly approved by the party responsible for compliance could void the user's authority to operate the equipment.

Note: This equipment has been tested and found to comply with the limits for a Class A digital device, pursuant to part 15 of the FCC Rules. These limits are designed to provide reasonable protection against harmful interference when the equipment is operated in a commercial environment.

This equipment generates, uses, and can radiate radio frequency energy and, if not installed and used in accordance with the instruction manual, may cause harmful interference to radio communications.

Operation of this equipment in a residential area is likely to cause harmful interference in which case the user will be required to correct the interference at his own expense.

EMC Performance of Cables and Connectors

Grass Valley products are designed to meet or exceed the requirements of the appropriate European EMC standards. In order to achieve this performance in real installations it is essential to use cables and connectors with good EMC characteristics.

All signal connections (including remote control connections) shall be made with screened cables terminated in connectors having a metal shell. The cable screen shall have a large-area contact with the metal shell.

SIGNAL/DATA PORTS

For unconnected signal/data ports on the unit, fit shielding covers. For example, fit EMI blanking covers to SFP+ type ports; and fit 75 Ω RF terminators to BNC type ports.

COAXIAL CABLES

Coaxial cables connections (particularly serial digital video connections) shall be made with high-quality double-screened coaxial cables such as Belden 8281 or BBC type PSF1/2M, Belden 1694A (for 3Gbps), and Belden 4794A (for 12Gbps).

toc

Table of Contents

1 Introduction	17
Overview	17
Benefits	18
Features	18
Unsupported Applications	18
Related Documentation	19
Block Diagram	19
Model Description	19
Unpacking	20
Supported MEDIA Port SFP28 Cartridges	20
Available Accessories	21
Required Materials	21
Video Resolution and SFP Cartridge Bandwidth and Quantity Requirements	21
Field-Replaceable Units	22
IPVU Mechanical Dimensions	22
IPVU-TRAY Mechanical Dimensions	23
IPVU-MOUNTING-KIT Mechanical Dimensions	23
Mounting on a Wall or Under a Table Top	24
Mounting with a Wall-Mounted Monitor	25
Mounting onto a VESA 75mm or 100mm Stand-Mounted Monitor	26
2 Connections and Cabling	27
Cabling Diagrams	27
Cabling to Support SMPTE 2022-7 with an IPVU	27
Electrical Connections, Reset Pushbutton, and Status Indicators	29
Status Indicator Interpretation	30
Status Indicator	30
SFP Cartridge 1 & 2 Status Indicators	30
Management Status Indicators (RJ-45 connector)	30
Reset Pushbutton	30
Locking Monitor Outputs	31
3 Installation	33
Fiber Optic Handling	33
Mounting Requirements	33
Mounting Options	34
Installing IPVUs in a 19" Rack	34
Mounting an IPVU on a Wall or Under a Table Top	35
Installing the IPVU into the IPVU-MOUNTING-KIT	38
Mounting an IPVU with a Wall-Mounted Monitor	39

IPVU Mounting Orientation for a Wall-Mounted Monitor	42
Mounting an IPVU onto a VESA 75mm or 100mm Stand-Mounted Monitor	43
IPVU Mounting Orientation for a Stand-Mounted Monitor	46
Securing the IPVU-MOUNTING-KIT with Fastener Points	47
Connecting the IPVU	48
4 IPVU Commissioning and Configuration	53
Factory Default IP Address and Network Port Usage	53
Installing RollCall	53
Firmware Upgrade	53
Terminology Used with RollCall	53
Navigating Pages in the RollCall Template	54
Template Pages	54
Setting Values	55
Information Display	55
Selecting the Information to Display	55
IPVU	56
Configuring 4K UHD Two-Sample Interleave Division for use with an IPVU Device	57
Configuring the Stream Inputs for use with 4K UHD SQD	58
Configuring HDR	59
Configuration	61
Time Sync Configuration	63
Status	64
Histogram	65
Receiver TPG (Test Pattern Generator)	65
Counters	66
FEC	67
NMOS	68
Ethernet Pages 1 and 2	70
The Ethernet Pane	70
Switch LLDP Info	71
The All Traffic/CPU Traffic Panes	71
Ethernet 1 and 2 RTP Receiver	71
Ethernet RTP Receiver Video Stats	72
Ethernet RTP Receiver Audio Stats	73
Audio V Fade	74
Input Loss Control	74
Spigot 1 to 8	75
Spigot use According to IPVU Output Resolution	75
Spigot Page Overview	76
Logging - Configuration	79
Logging - System	80
Logging - Network	83
Logging - Network - 1G	86
Logging - SFP	88
Logging - FPGA	91
Logging - Spigot 1 to 8	92
Logging - NMOS	93
Logging - Card Diagnostics	95

Setup	97
Restart	97
Defaults	98
Ethernet Gb	98
The Ethernet Pane	98
Interop	99
SFP Configuration	100
5 Maintenance & Troubleshooting	101
Maintenance	101
Power Cycling an IPVU	101
Saving and Restoring an IPVU's Configuration	101
Upgrading the IPVU's Firmware	102
Troubleshooting	106
Testing if Network Redundancy (SMPTE ST 2022-7) is Working	107
Keep Fiber Connections Clean	108
6 Specifications	109
Status LEDs	109
Inputs & Outputs	109
MEDIA 1 & 2 Ports	109
IP Channel Inputs	110
MONITOR OUT	110
MANAGEMENT Port	110
Power	110
Status Indicators	111
Environmental	111
Compliance	111
Appendix A Installing the SFP Ethernet Module	113
Introduction	113
Installing an SFP module	113
Connecting the fiber optic cables	114
Removing the fiber optic cables	114
Removing the SFP module	114

1 Introduction

Overview

The IPVU is a compact dual channel IP to HDMI converter that's perfect for displaying IP sources and multiviewer's IP outputs on HD and UHD monitors with an HDMI input.

The IPVU can be installed on a rack shelf or mounted behind the display, and provides the missing link to view any IP source, or to connect an IP multiviewer's output to its display.

It supports ST 2110, ST 2022-6¹, and ST 2022-7 Class A. Each channel is completely independent which optimizes the bandwidth usage on the IP fabric, which in turn reduces the total cost of the system by halving the number of required switch ports and optical SPFs versus a single channel device. The IPVU dynamically adapts to any stream presented to it.

Two models are available: one for 720p/1080i/1080p resolutions, and one for 720p/1080i/1080p/2160p resolutions.

Fully integrated into the GV Convergent system, it can be dynamically controlled to route any IP source to the display.

Due to its compact size, the following mounting options are available:

- It can be deployed in close proximity to the LCD display, where it can be mounted behind the display.
- It can be attached to the underside of a tabletop or to a wall surface.
- It can be rack mounted on an optional shelf.

The IPVU has an integrated universal power supply, two IP network SFP cartridge slots, and an IP management port.

This installation manual describes how to install and use the IPVU.



1. Video essence only. Audio and ancillary essences for this flow type are unsupported.

Benefits

- Dual channel to optimize switch port bandwidth usage.
- Low processing latency for critical monitoring applications.
- In-band² or out-of-band control for more flexibility.
- Clean switch between two IP sources with no video loss (make before break or freeze frame).
- UHD resolution support at full 50 or 59.94 frame rates with ST 2022-7 hitless redundancy.

Features

- Optional bracket for VESA mounting an IPVU behind a display.
- Optional 1 RU rack shelf which holds up to three IPVUs.

Unsupported Applications

Using the IPVU in the following scenarios have not been tested or are unsupported:

- Use with any video adapter such as a monitor output to SDI converter.
- Use with monitor output cables longer than 6 feet (2 meters).
- Use with range extender type monitor output cables.
- SFP cartridges other than the one specified in [Supported MEDIA Port SFP28 Cartridges](#), on page 20.
- Use with monitors that only support 25 or 30 Hz refresh rates. Monitors must support 50 or 59.9 Hz refresh rates.
- Use of a higher-resolution IPVU output than supported by the monitor. The IPVU does not up or down-scale its output.

IPVU's Output Resolution	Supported Monitor Resolution		
	720p	1080i / 1080p	2160p
720p	●	● ^a	● ^a
1080i / 1080p		●	● ^a
2160p			●

a. The monitor must support internal upscaling.

2. Available on demand.

Related Documentation

The following related documentation is available. You can obtain the latest product documentation from the Documentation Library section of Grass Valley's website.

Document Number	Title
13-03068-010-M00	IPVU Installation Guide (this document)
13-03068-030-M00	IPVU Release Notes
13-03068-020-M00	IPVU Documentation Resource Guide
-	RollCall V4 Suite & RollCall Lite Installation Guide
-	RollCall Control Panel User Manual

Block Diagram

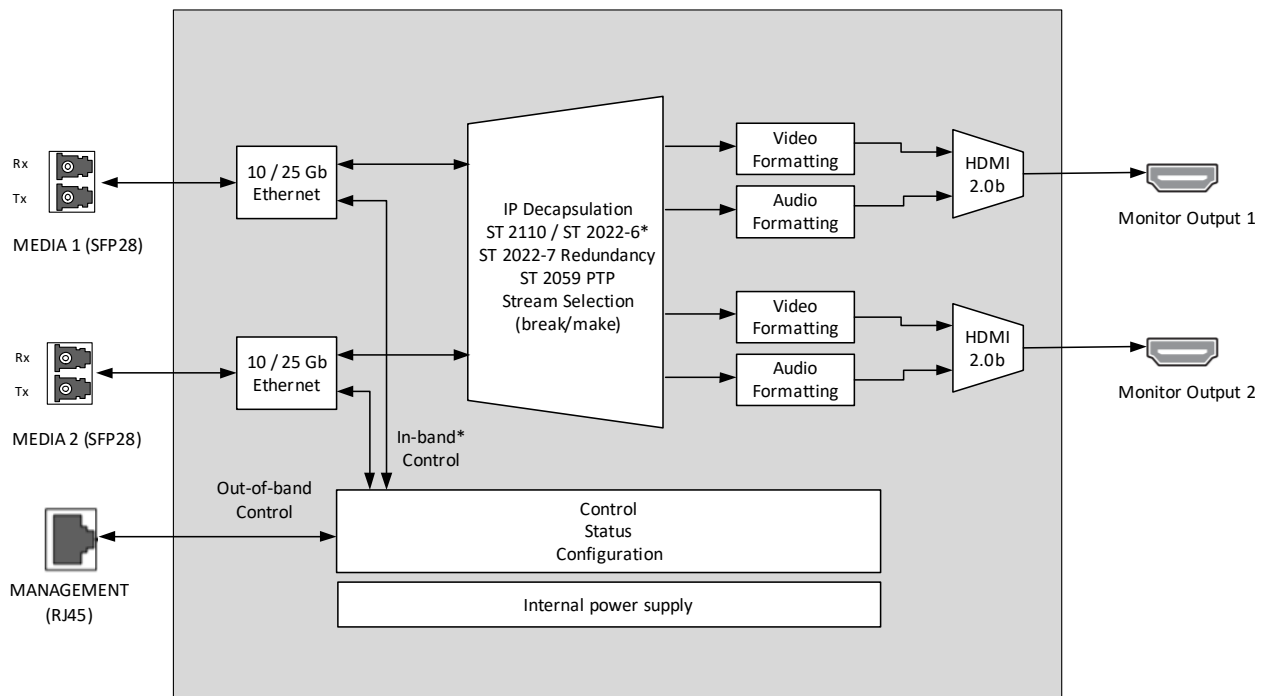

Fig. 1-1: IPVU Functional Block Diagram

Model Description

The following IPVU models are available.

Model	Description
IPVU	Display HD and 3G video formats to HDMI 1.4b or higher monitor outputs.
IPVU-UHD	Display HD/3G, and UHD video formats to Dual HDMI 2.0b or higher monitor outputs.

See [Unpacking](#), on page 20 for the shipping box contents.

Unpacking

Unpack the IPVU. The kit should contain the following items. If anything is missing, contact your distributor or Grass Valley (see [Grass Valley Technical Support](#), on page 116).

Supplied Quantity	Description	Supplied with the IPVU	
		HD and 3G video	HD/3G, and UHD video
1	IPVU (IPVU).	●	
1	IPVU (IPVU-UHD).		●
1	Power cord with attached IEC 60320 C13 connector.	●	●

Supported MEDIA Port SFP28 Cartridges

One or two SFP28 cartridges are required (extra). These are shipped as a separate order. See also [Video Resolution and SFP Cartridge Bandwidth and Quantity Requirements](#), on page 21.

Model	Description
SFP-ETH10G-RT-M85-LC	Short range optical 10GBase Ethernet SFP cartridge with LC/PC fiber connector: <ul style="list-style-type: none"> • <300m link with OM3 MMF. • <82m link with OM2 MMF. • <33m link with OM1 MMF. 850 nm multi-mode optical transceiver that supports signals up to 10.5 Gb/s for bidirectional serial data communications such as 10GBASE-SR and 10GBASE-SW.
SFP-ETH10G-RT-S13-LC	Long range optical 10GBase Ethernet SFP cartridge with LC/PC fiber connector (<10 000m): 1310 nm single mode optical transceiver that supports signals up to 10.5 Gb/s for bidirectional serial data communications such as 10GBASE-LR and 10GBASE-LW.
SFP-25-SR	Short range SFP28 25GBASE Optical Transceiver MMF cartridge (<300m).
SFP-25-LR	Long range SFP28 25GBASE Optical Transceiver SMF cartridge (<10 000m).

Available Accessories

The following optional accessories are available.

Model	Description
IPVU-TRAY	19" rack mount shelf for 1 RU rack installation of up to three IPVUs.
IPVU-MOUNTING-KIT	Mounting kit for attaching the IPVU to the back of a display or a wall. Works with VESA 75/100 and large LCD mounting brackets.

Required Materials

Field-supplied materials that must be provided.

Required Quantity	Description
1 or 2	Fiber optic cable to connect between the IPVU and network switch. The ends must be terminated with the appropriate connectors.
1 or 2	Standard monitor cable with connectors at each end: <ul style="list-style-type: none"> • Type A connector at the IPVU end. • The appropriate connector for you monitor's input connector.
	Tie-wraps to bundle up excess cable lengths and to secure cables in place.

Video Resolution and SFP Cartridge Bandwidth and Quantity Requirements

Network bandwidth requirements depend on the resolution of the video stream being sent to the IPVU. SMPTE 2022-7 provides stream redundancy and requires the use of two SFP cartridges at minimum. The network media switch must also be capable of supporting the same bandwidth of the SFP cartridge you are going to use.

IPVU Video Output Streams	Without SMPTE 2022-7		With SMPTE 2022-7	
	Network Bandwidth	Required SFP Cartridge	Network Bandwidth (total)	Required SFP Cartridges
1 × HD	3 Gb	1 × 10 Gb or 1 × 25 Gb or 2 × 10 Gb or 2 × 25 Gb	6 Gb	2 × 10 Gb or 2 × 25 Gb
2 × HD	6 Gb	1 × 10 Gb or 1 × 25 Gb or 2 × 10 Gb or 2 × 25 Gb	12 Gb	2 × 10 Gb or 2 × 25 Gb
1 × UHD	12 Gb	1 × 25 Gb or 2 × 25 Gb	24 Gb	2 × 25 Gb

IPVU Video Output Streams	Without SMPTE 2022-7		With SMPTE 2022-7	
	Network Bandwidth	Required SFP Cartridge	Network Bandwidth (total)	Required SFP Cartridges
1 × UHD & 1 × HD	15 Gb	1 × 25 Gb or 2 × 25 Gb	30 Gb	2 × 25 Gb
2 × UHD	24 Gb	1 × 25 Gb or 2 × 25 Gb	48 Gb	2 × 25 Gb

Only the IPVU-UHD supports UHD output.

Field-Replaceable Units

The following units are field-replaceable for maintenance purposes.

FRU part number	Description
IPVU	HD and 3G video.
IPVU-UHD	HD/3G, and UHD video.

IPVU Mechanical Dimensions

The following diagram shows the IPVU's physical dimensions.

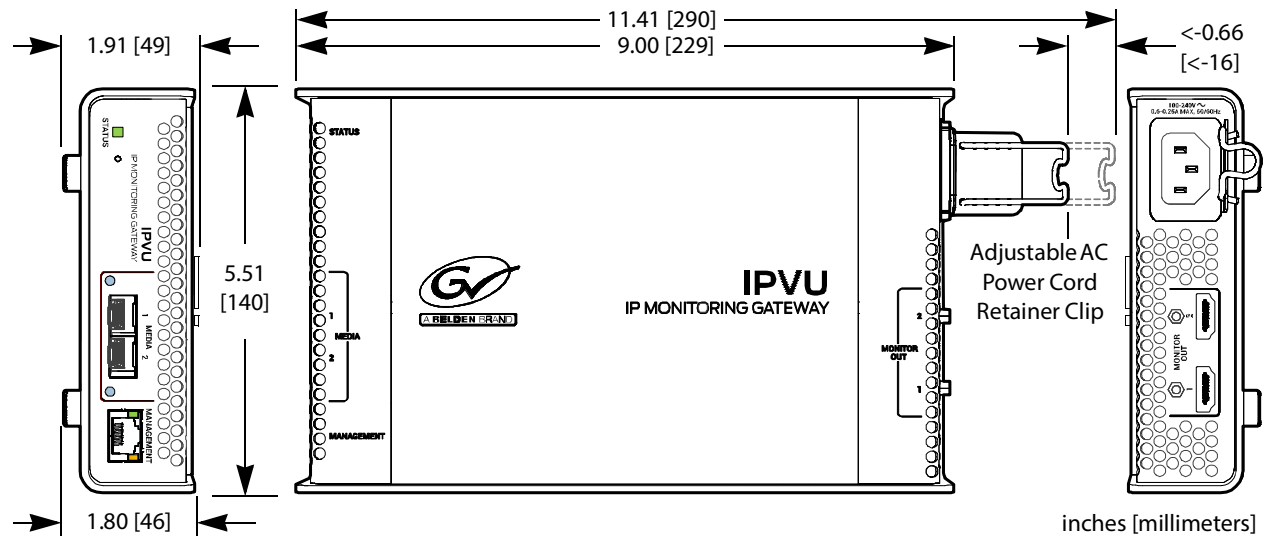

Fig. 1-2: IPVU dimensions

IPVU-TRAY Mechanical Dimensions

The following diagram shows the IPVU-TRAY's physical dimensions.

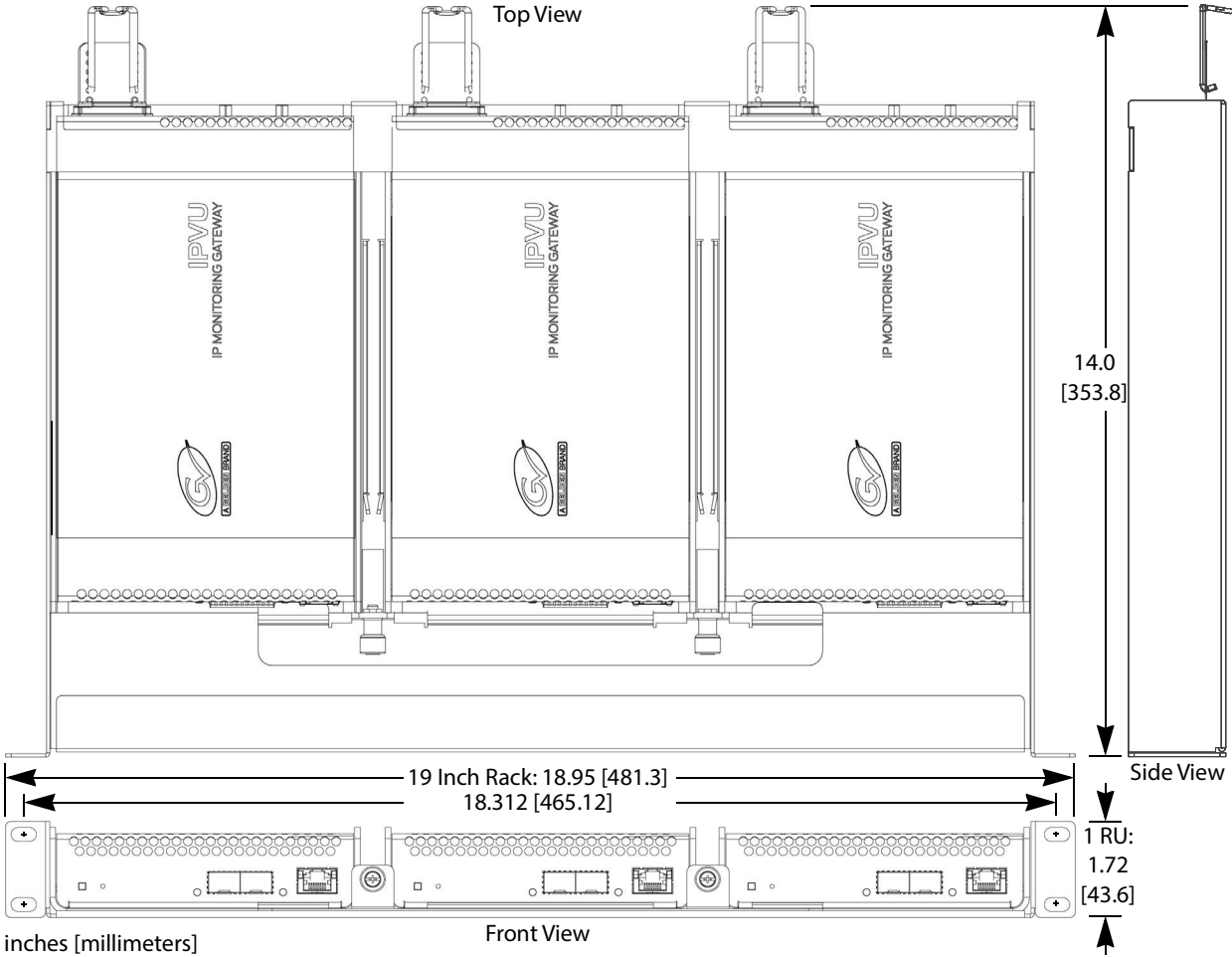

Fig. 1-3: IPVU-TRAY dimensions

IPVU-MOUNTING-KIT Mechanical Dimensions

The following diagrams shows the IPVU-MOUNTING-KIT's physical dimensions.

Mounting on a Wall or Under a Table Top

The bracket of the IPVU-MOUNTING-KIT can be attached to a hard surface with screw fasteners.

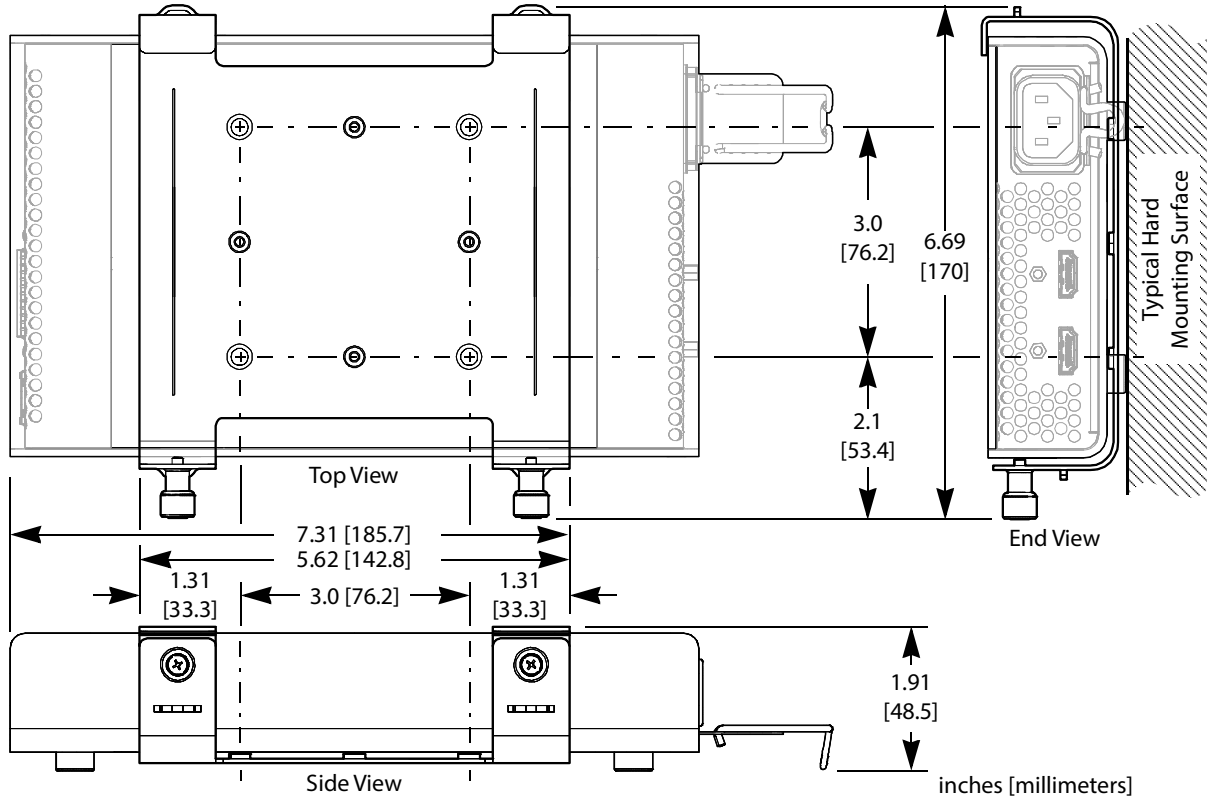

Fig. 1-4: IPVU-MOUNTING-KIT dimensions for a hard surface installation

Mounting with a Wall-Mounted Monitor

The bracket of the IPVU-MOUNTING-KIT can be attached to the wall mount support of a monitor that is 32 inches diagonal or larger.

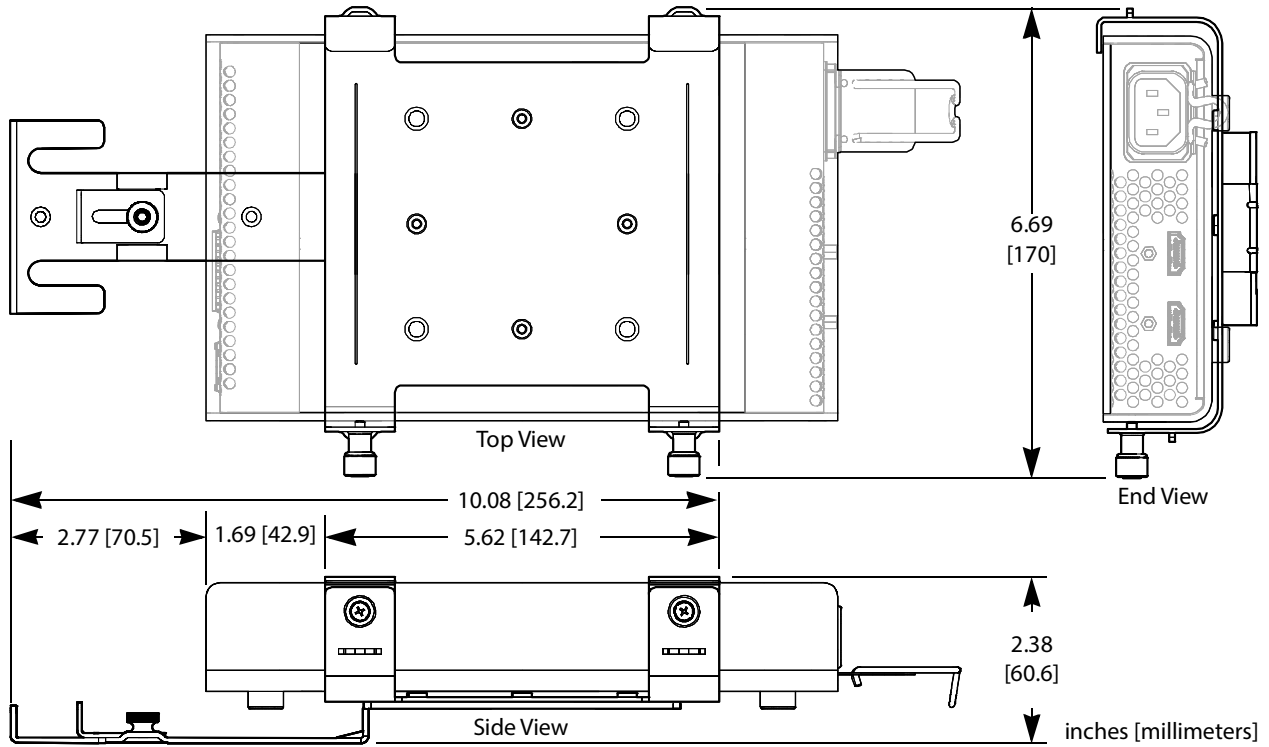

Fig. 1-5: IPVU-MOUNTING-KIT dimensions for a wall-mounted monitor installation

Mounting onto a VESA 75mm or 100mm Stand-Mounted Monitor

The bracket of the IPVU-MOUNTING-KIT can be attached to a VESA 75mm or 100mm monitor stand of a monitor that is 31 inches or smaller.

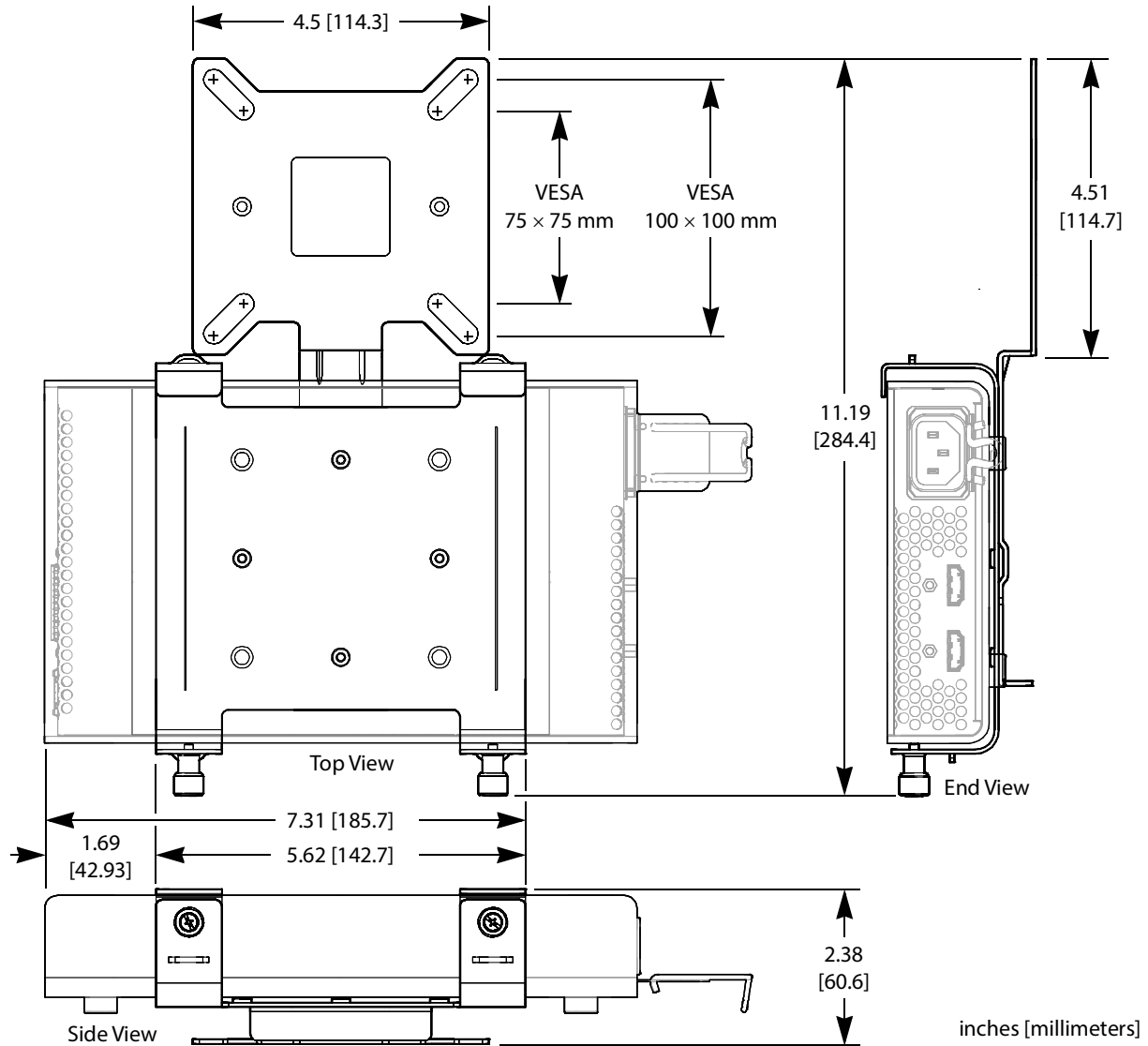

Fig. 1-6: IPVU-MOUNTING-KIT dimensions for a VESA 75 mm or 100 mm stand-mounted monitor installation

Connections and Cabling

Cabling Diagrams

The IPVU is intended to be used in close proximity to the monitor, using a 6 foot or shorter cable between the IPVU and the monitor.

The following figure shows the typical connections for an IPVU.

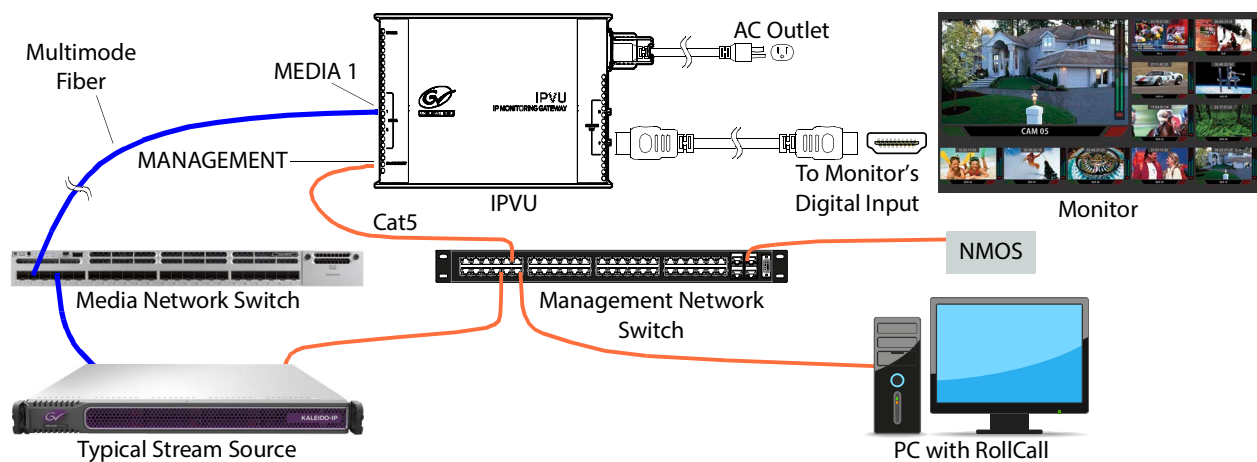

Fig. 2-1: Typical IPVU application

Cabling to Support SMPTE 2022-7 with an IPVU

The IPVU supports network redundancy, for use with any SMPTE 2022-7 compatible equipment.

To make streaming more reliable over an IP network, the implementation of SMPTE 2022-7 seamless protection switching depends on stream redundancy. This protection scheme transmits two identical packet streams over physically separate network routes (shown as Media Red LAN and Media Blue LAN in the figure below), so that if packets from one route are lost, the data can be reconstructed using packets from the second stream. This process

is seamless because switching between the streams is instantaneous and does not impact content.

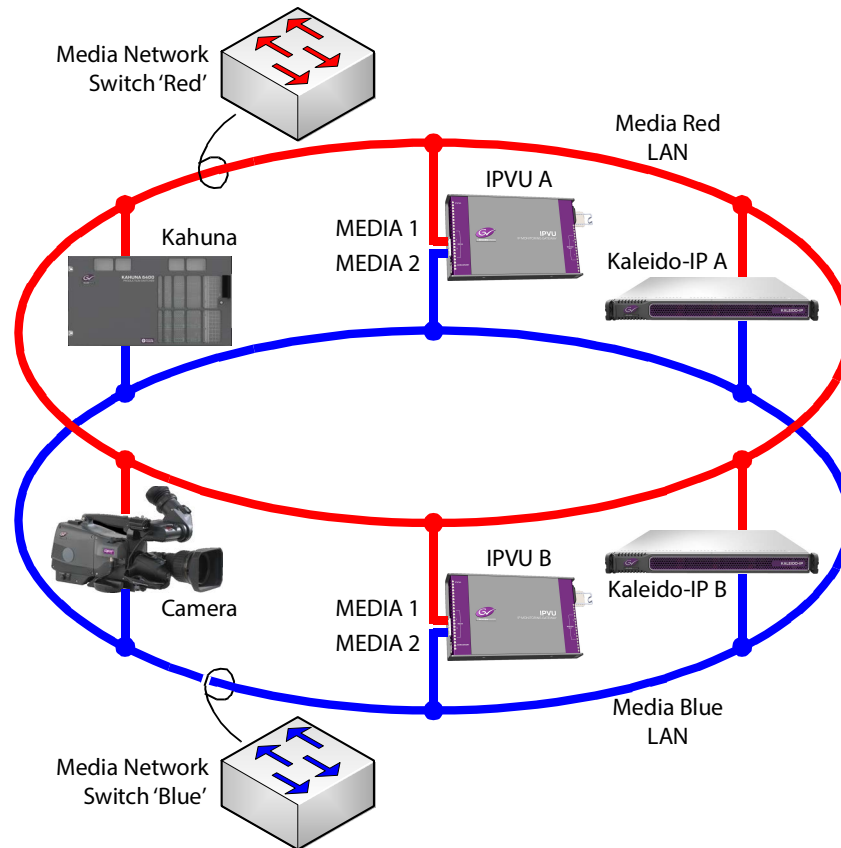
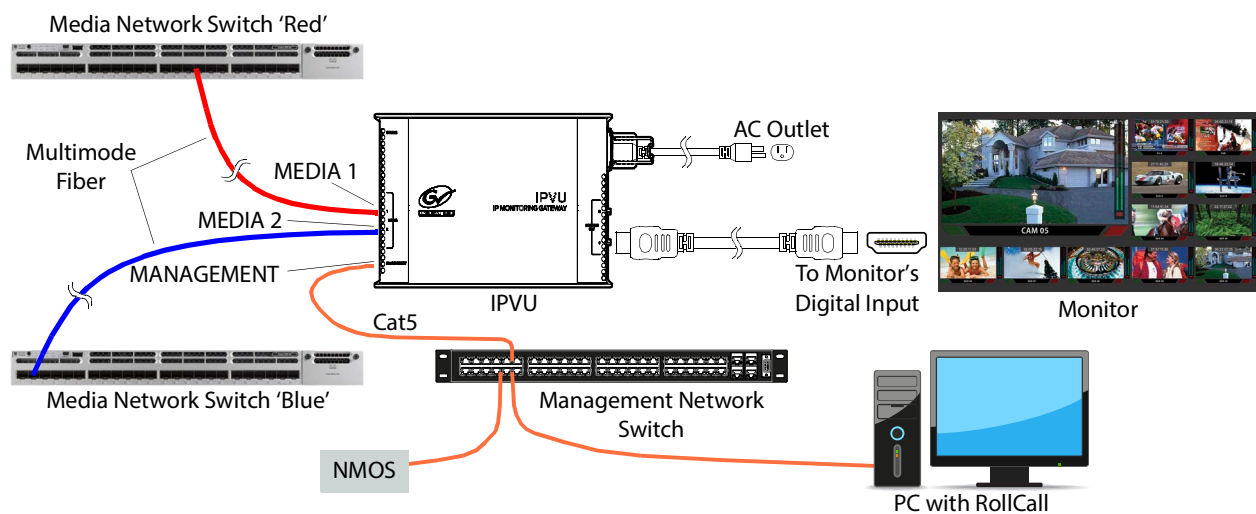

Fig. 2-2: Typical SMPTE 2022-7 IPVU Network Overview

The cabling connections are shown in greater detail below.



PREREQUISITES:

- At least two DCNM-compliant switches must be used for this application. Contact Grass Valley for more information about switch compatibility. See [Grass Valley Technical Support](#), on page 116.
- For the IPVU, in Rollcall's **Spigot panel, Primary / Secondary** tab, make sure to change the **Flow Type** from **None** to **2110-20**. See [Spigot 1 to 8](#), on page 75.

Electrical Connections, Reset Pushbutton, and Status Indicators

The following diagram shows the IPVU's electrical connections, reset pushbutton, and the location of status indicators.

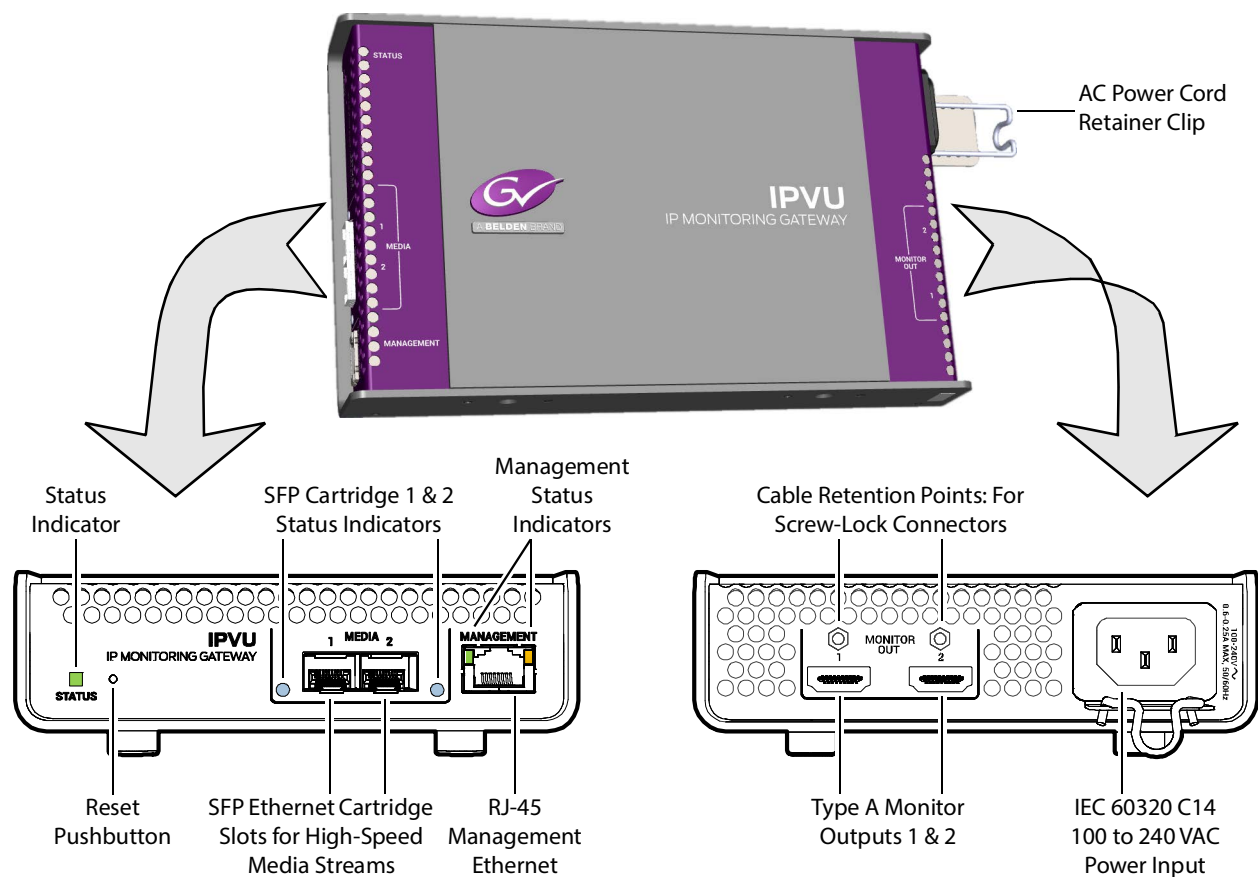

Fig. 2-3: IPVU Connections and Overview

Connection Nomenclature	Configuration Nomenclature	See
MEDIA 1	SFP 1	Ethernet Pages 1 and 2 , on page 70
MEDIA 2	SFP 2	

Connection Nomenclature	Configuration Nomenclature	See
MANAGEMENT	Ethernet Gb	Ethernet Gb , on page 98
MONITOR OUT 1 & 2	Spigot	Spigot use According to IPVU Output Resolution , on page 75

Status Indicator Interpretation

Status Indicator

This shows the overall health of the IPVU.

Status Indicator Color	Interpretation
Solid green	IPVU is in a normal state.
Solid red	IPVU is starting up.

SFP Cartridge 1 & 2 Status Indicators

This shows the health of the media Ethernet link to the switch.

Status Indicator Color	Interpretation
Off	SFP cartridge not installed.
Blue	25G link up.
Flashing blue	25G link down.
Green	10G link up.
Flashing green	10G link down.

Management Status Indicators (RJ-45 connector)

This shows the health of the media Ethernet link to the switch.

Status Indicator Color		Interpretation
Green LED	Yellow LED	
Solid	Blinking	100Mb/s Ethernet connection.
Blinking	Blinking	1Gb/s Ethernet connection.

Reset Pushbutton

This recessed button restores the IPVU to its factory default settings, including its IP address. Press reset for 3 seconds to reset the IPVU. See also [Factory Default IP Address and Network Port Usage](#), on page 53.

Locking Monitor Outputs

The IPVU monitor outputs are equipped with two 4-40 UNC thread standoff nuts, to be used with locking cables.

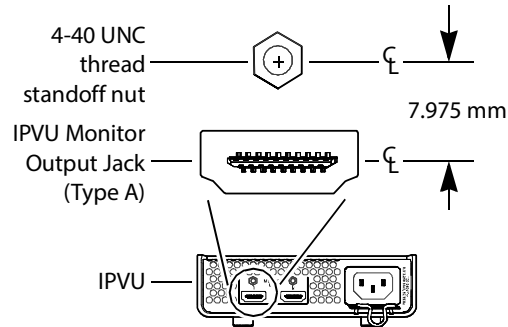

Fig. 2-4: Monitor outputs: the required distance between the screw lock pin and connector

Screw-lock connectors can optionally be used with the IPVU's monitor outputs when the spacing between the screw lock pin and the connector, as shown in the above diagram, is met. This type of connector secures the connection to prevent an accidental disconnect. Cable assemblies with regular, non-locking connectors can equally be used for the monitor outputs.

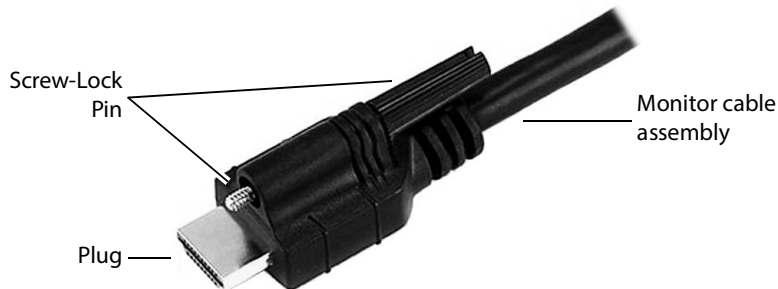

Fig. 2-5: Typical screw-lock connector with a Type A male connector

3 Installation

Fiber Optic Handling

CAUTION

Never assume a fiber is dark. Never look directly into the end of a fiber cable. All employees in the area must wear laser safety glasses with side shields.

Installing connectors on a fiber requires special handling procedures. Read and follow the fiber and connector manufacturer's instructions.

Protect fiber cable ends and optical ports on equipment from dust and dirt.

- When a fiber cable is disconnected, fit a protective cap on the end.
- When no fiber cable is connected to an optical port, insert a protective cap.

Store unused protective caps in an airtight container to prevent the transfer of dust to the fiber connectors when used in the future.

Mounting Requirements

The IPVU has an internal cooling fan that cools the electronic components inside the IPVU. The internal cooling fan pushes air in the direction shown below.

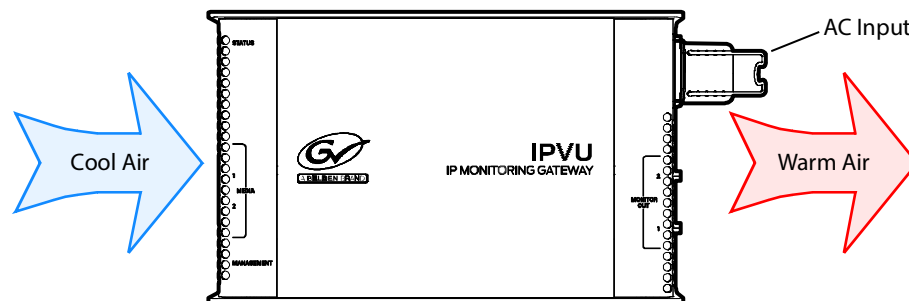

Fig. 3-1: IPVU Air flow

Mounting Options

Optional mounting kits are available to mount the IPVU as follows.

Mounting Method	Required mounting kit	Description	See
1 RU 19" Rack	IPVU-TRAY	19" rack mount shelf for 1 RU rack installation of up to three IPVUs.	Installing IPVUs in a 19" Rack , on page 34
Wall or under a table top	IPVU-MOUNTING-KIT	Mount an IPVU on a hard surface.	Mounting an IPVU on a Wall or Under a Table Top , on page 35
Large LCD Wall Mounting Bracket	IPVU-MOUNTING-KIT	Attach an IPVU to a wall-mounted monitor.	Mounting an IPVU with a Wall-Mounted Monitor , on page 39
VESA Mount 75 or 100 mm	IPVU-MOUNTING-KIT	Attach an IPVU to a VESA stand-mounted monitor support arm.	Mounting an IPVU onto a VESA 75mm or 100mm Stand-Mounted Monitor , on page 43
Nylon cable tie	IPVU-MOUNTING-KIT	Use nylon cable ties to secure the IPVU in place. Use this method to secure the IPVU when the above methods are unavailable.	Securing the IPVU-MOUNTING-KIT with Fastener Points , on page 47

Installing IPVUs in a 19" Rack

The IPVU-TRAY mounting kit holds up to three IPVUs in 1 RU.

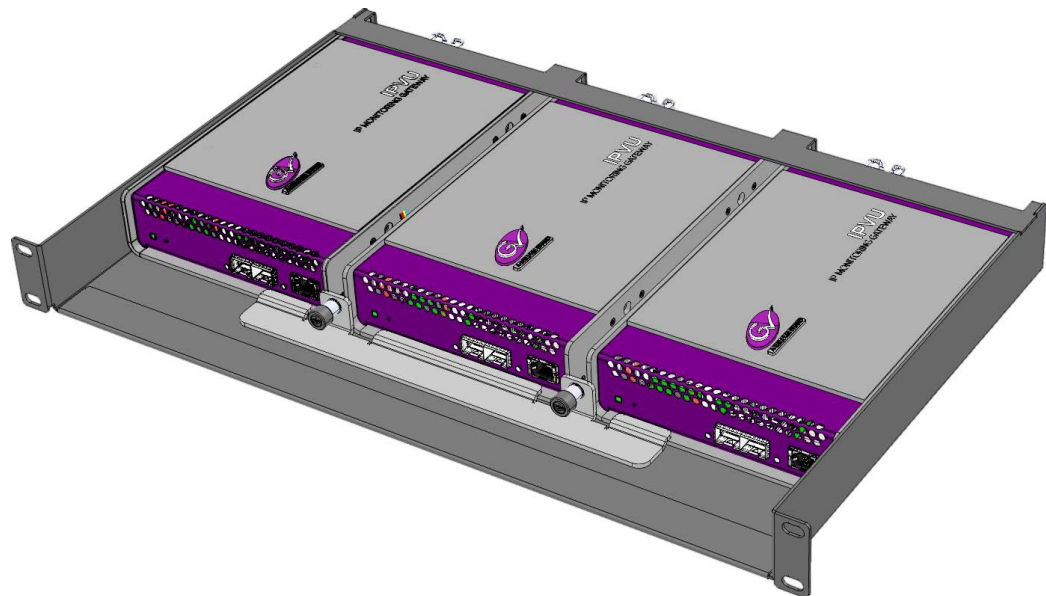
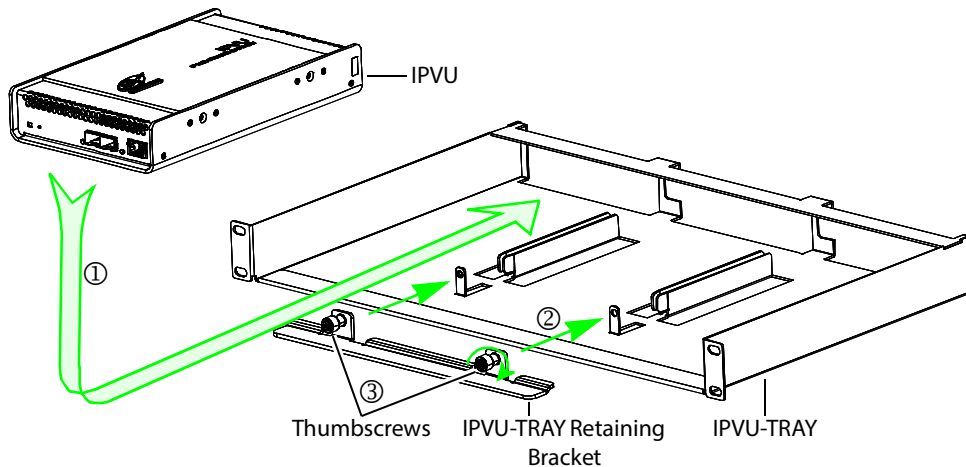

Fig. 3-2: Typical IPVU-TRAY installation

To install the IPVU-TRAY mounting kit in a 19" rack

- 1 Install the IPVU-TRAY shelf into the rack. Use the four supplied rack screws to attach the shelf to the rack.
- 2 From the rear of the rack, pull through the power and monitor cables required for each space in the shelf where each IPVU is to be installed. See [Cabling Diagrams](#), on page 27.
- 3 Connect the power and monitor cables to an IPVU (see [Connecting the IPVU](#), on page 48) and ① slide it into its space in the shelf. Repeat for the remaining IPVUs to be installed.



- 4 Install the ② retaining bracket and tighten the ③ thumbscrews to securely hold the IPVUs in place.
- 5 Connect the network cables to the IPVU. See [Connecting the IPVU](#), on page 48. Repeat for the remaining IPVUs.

Mounting an IPVU on a Wall or Under a Table Top

The optional IPVU-MOUNTING-KIT can be used to mount an IPVU on a wall or under a table top.

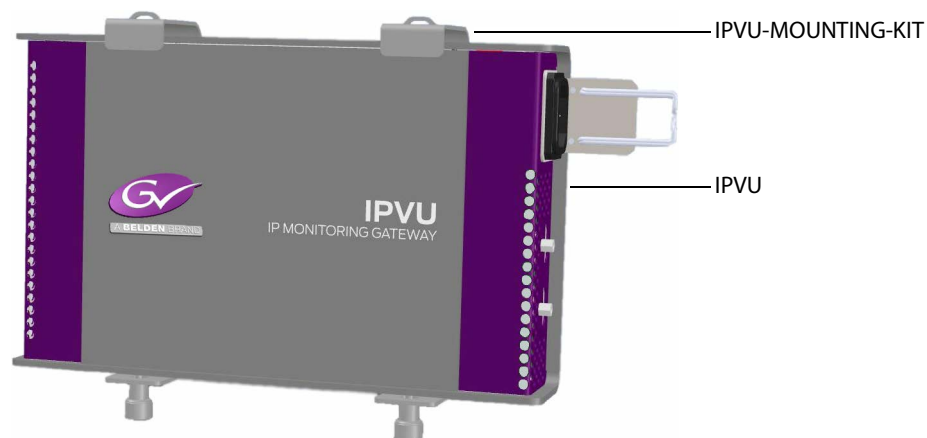

Fig. 3-3: Typical IPVU-MOUNTING-KIT surface installation

Installation

Mounting an IPVU on a Wall or Under a Table Top

When mounting the IPVU on a wall behind a monitor, operate the monitor for 30 minutes and then feel the rear housing with your hand. Avoid mounting the IPVU behind the monitor in areas where the monitor is warm to the touch and above these warm spots.

When mounting an IPVU on a wall (vertically), the optimal mounting positions are shown below. Choose a position that allows for accessibility for maintenance and troubleshooting purposes, for example, ensuring the IPVU's status indicators can be seen.

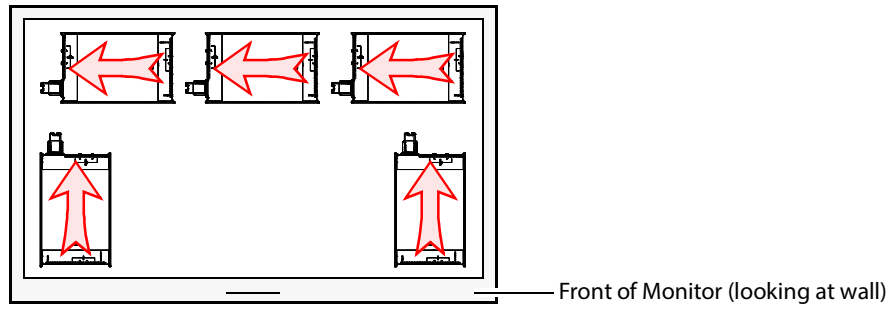

Fig. 3-4: Optimal IPVU mounting positions when located behind a monitor or mounted on a wall.

The I IPVU-MOUNTING-KIT's screw hole locations are shown below.

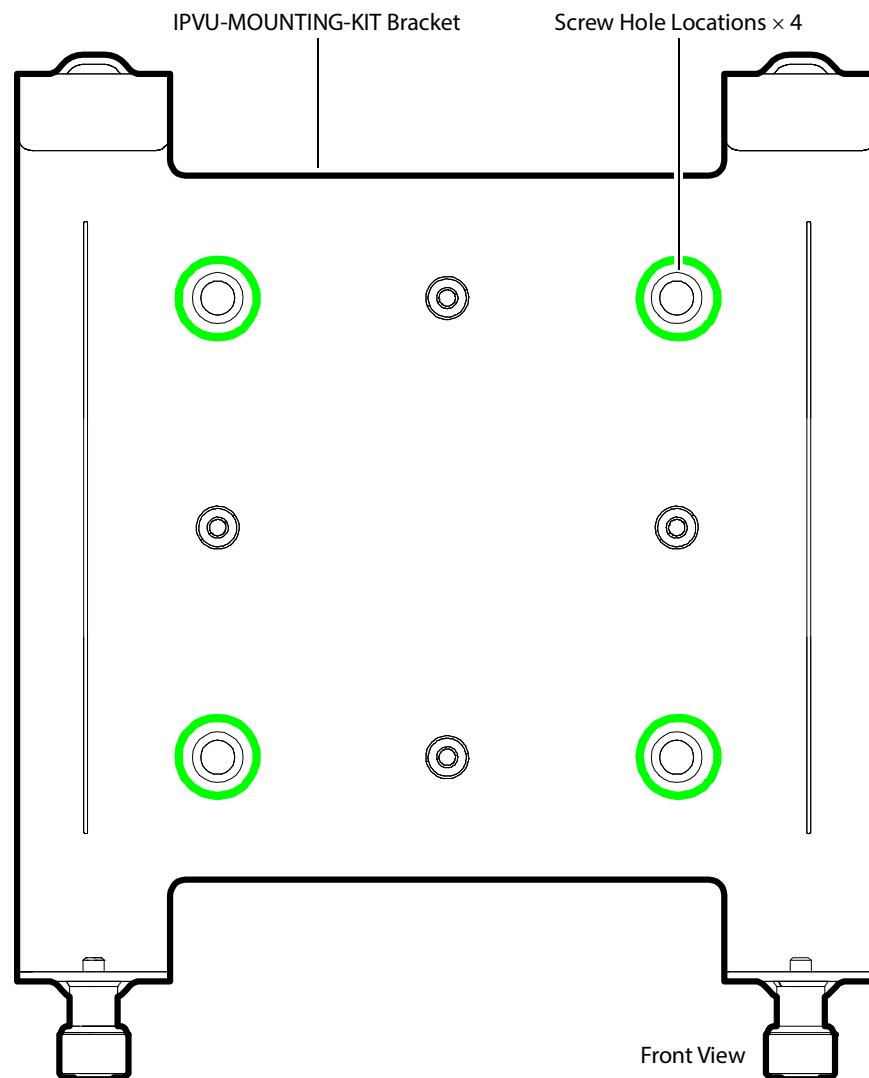

Fig. 3-5: Screw hole locations for wall mounting the IPVU-MOUNTING-KIT

To install the IPVU-MOUNTING-KIT on a wall or under a table top

- 1 Identify the screw hole locations on the IPVU-MOUNTING-KIT bracket. See Figure 3-5.
- 2 Identify where you want to locate the IPVU and mark the screw hole locations on the mounting surface. Note that only two of the four screw hole locations need to be used: choose two screw hole locations that are diagonally opposite to each other.
- 3 Using a screw fastening system that is adapted to the surface's material composition (for example, for a gyprock wall, use plastic anchors and screws), attach the IPVU-MOUNTING-KIT bracket to the surface.
- 4 Install the IPVU into the IPVU-MOUNTING-KIT bracket. See [Installing the IPVU into the IPVU-MOUNTING-KIT](#), on page 38.
- 5 Connect all cables to the IPVU. See [Connecting the IPVU](#), on page 48.
- 6 Connect power to the monitor.

Installing the IPVU into the IPVU-MOUNTING-KIT

The IPVU is attached to the IPVU-MOUNTING-KIT with two thumbscrews as shown below.

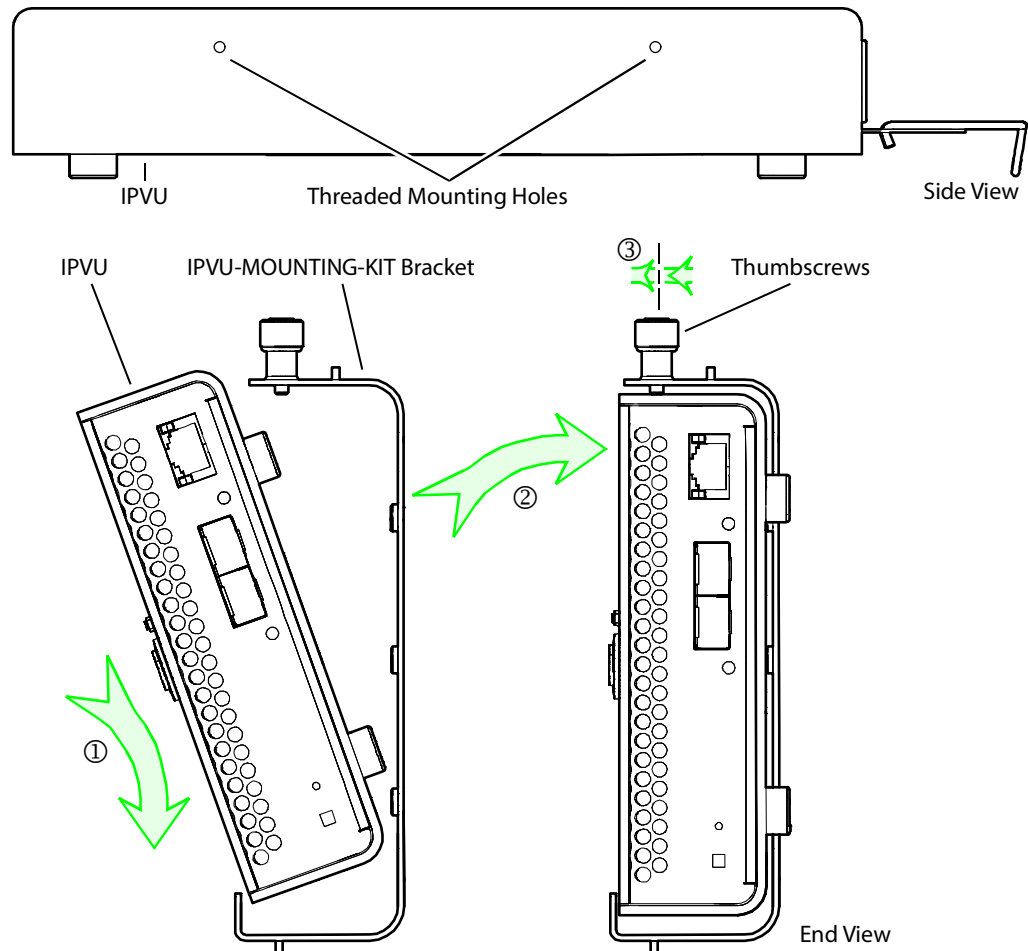

Fig. 3-6: Installing the IPVU into the IPVU-MOUNTING-KIT

To install the IPVU into the IPVU-MOUNTING-KIT

- 1 Identify the threaded mounting holes on the side of the IPVU.
- 2 Tilt and lower the IPVU into the IPVU-MOUNTING-KIT bracket ①.
- 3 Raise the IPVU such that the thumbscrews align with the threaded mounting holes ②.
- 4 Tighten the thumbscrews ③ to securely hold the IPVU in place.

Mounting an IPVU with a Wall-Mounted Monitor

The IPVU-MOUNTING-KIT can be used with a wall mounted monitor that is 32 inches diagonal or larger.

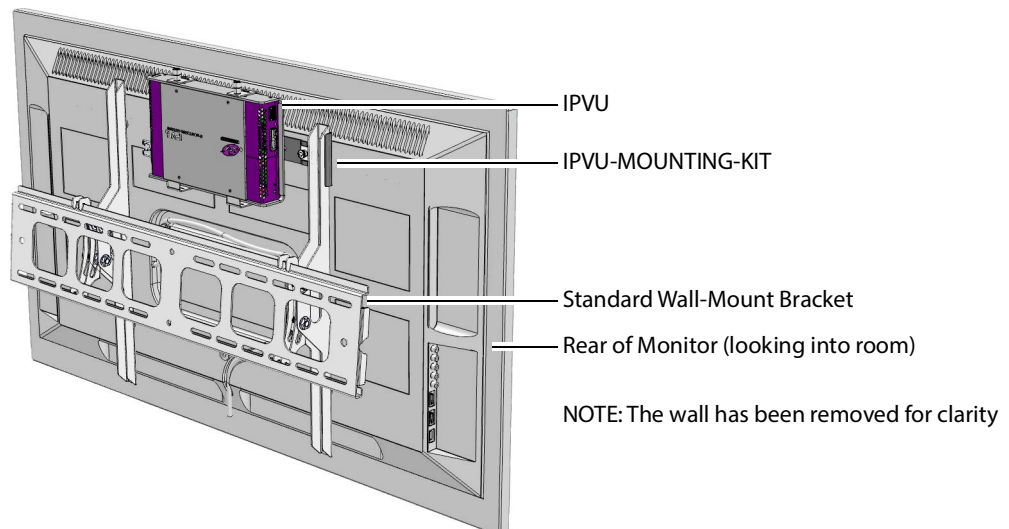

Fig. 3-7: IPVU-MOUNTING-KIT for wall-mounted monitors that are 32 inches diagonal or larger

When mounting the IPVU behind a monitor, operate the monitor for 30 minutes and then feel the rear housing with your hand. Avoid mounting the IPVU behind the monitor in areas where the monitor is warm to the touch and above these warm spots. Choose a position that allows for accessibility for maintenance and troubleshooting purposes, for example, ensuring the IPVU's status indicators can be seen.

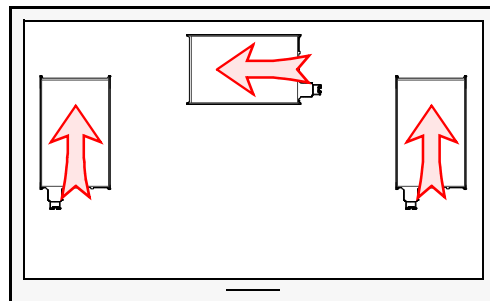

Fig. 3-8: Optimal IPVU mounting positions when located behind a monitor.

To install an IPVU with a Wall-Mounted Monitor

This procedure assumes that the monitor has already been attached to the wall with a wall-mount bracket.

- 1 Use two screws to assemble the IPVU-MOUNTING-KIT as shown below. Set the IPVU's mounting orientation; see [IPVU Mounting Orientation for a Wall-Mounted Monitor](#), on page 42.

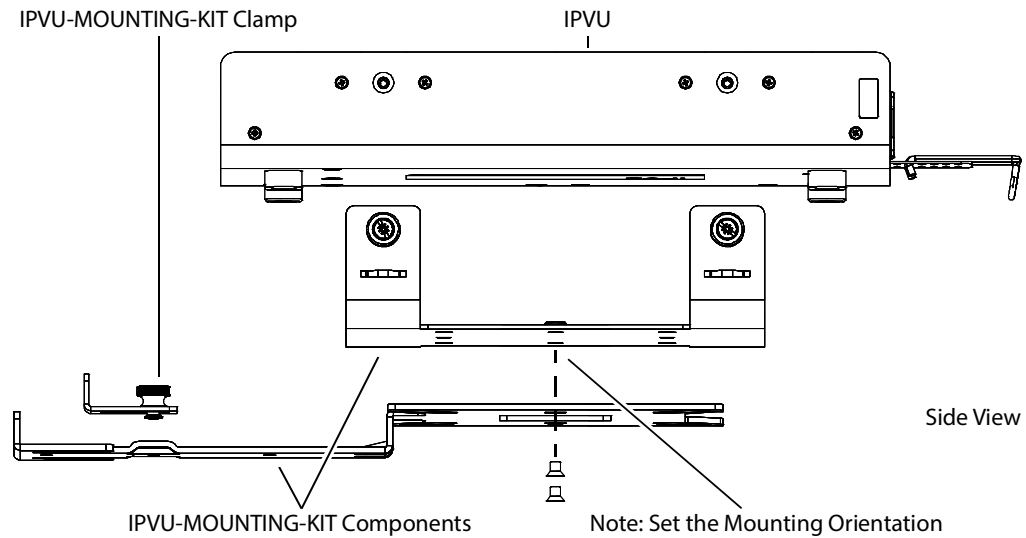

Fig. 3-9: Assemble the IPVU-MOUNTING-KIT for use with a wall-mounted monitor

- 2 Attach the clamp, but leave it loose.
- 3 Take the monitor off the wall.
 - Disconnect any cables.
 - Lift and detach the monitor from the wall-support rail.
- 4 Remove the screw that attaches the wall-mount bracket to the monitor in the corner where the IPVU is to be installed.

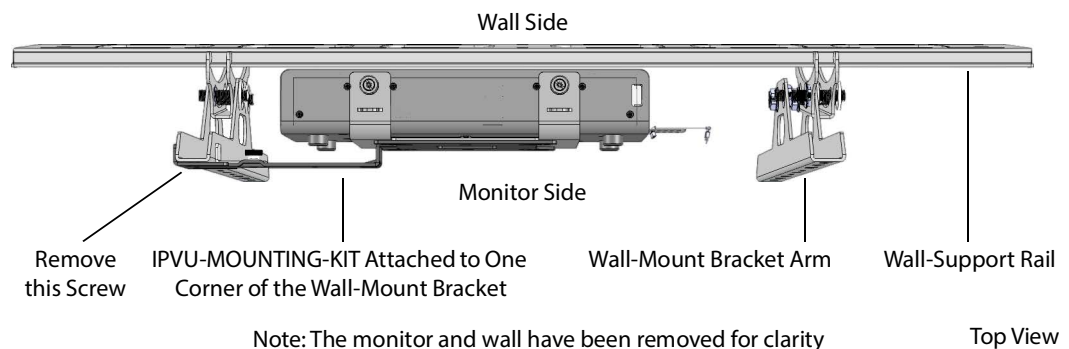

Fig. 3-10: IPVU-MOUNTING-KIT overview for use with a wall-mounted monitor

- Slide the IPVU-MOUNTING-KIT down between the wall-mount bracket and the monitor (as shown in Figure 3-12) until the lower IPVU-MOUNTING-KIT slot aligns with the Wall-Mount Bracket's screw location. Using the lower IPVU-MOUNTING-KIT slot provides better leverage to support the IPVU's weight.

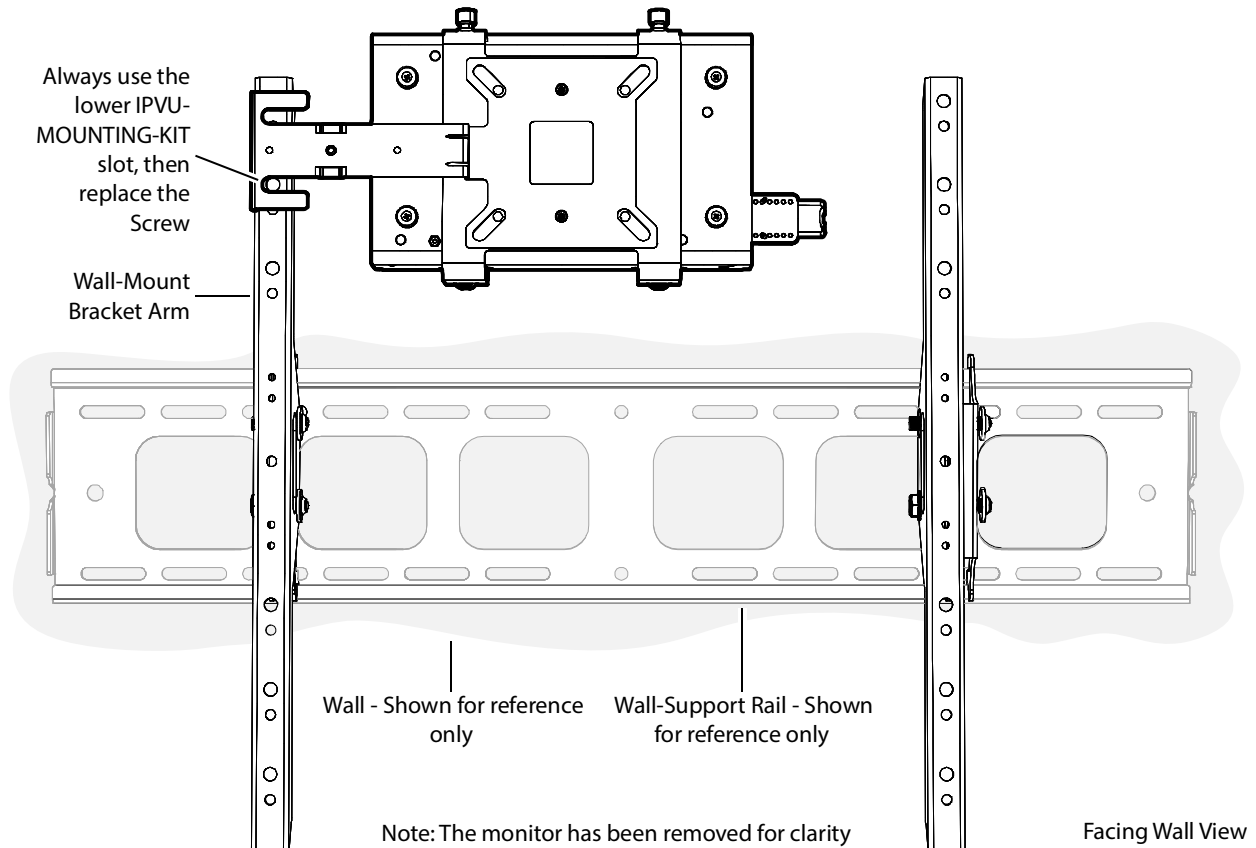

Fig. 3-11: Attaching the IPVU-MOUNTING-KIT to the wall-mount bracket

- Replace the Wall-Mount Bracket Arm's screw to securely hold both the monitor and the IPVU assembly.

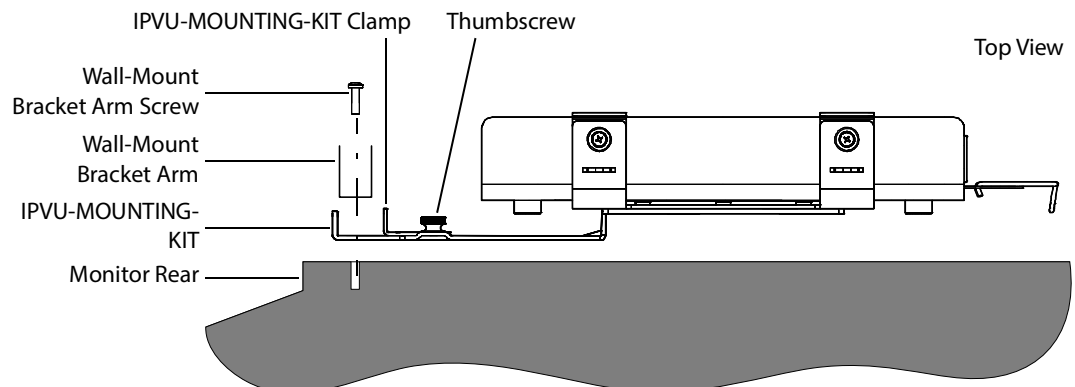

Fig. 3-12: Assembly order of the IPVU-MOUNTING-KIT to the wall-mount bracket

- 7 Snug the IPVU-MOUNTING-KIT's clamp up to the wall-mount bracket's arm and tighten the thumbscrew to further support the IPVU.
- 8 Install the IPVU into the IPVU-MOUNTING-KIT bracket. See [Installing the IPVU into the IPVU-MOUNTING-KIT](#), on page 38.
- 9 Connect all cables to the IPVU. See [Connecting the IPVU](#), on page 48.
- 10 Hang the monitor back onto the wall-support rail and secure it into place.
- 11 Reconnect power to the monitor.

IPVU Mounting Orientation for a Wall-Mounted Monitor

The IPVU can be attached to the IPVU-MOUNTING-KIT bracket in either of two orientations: *Linear* or *Perpendicular*. This choice is made during the assembly of the IPVU-MOUNTING-KIT bracket by choosing the appropriate set of attachment points, as shown below.

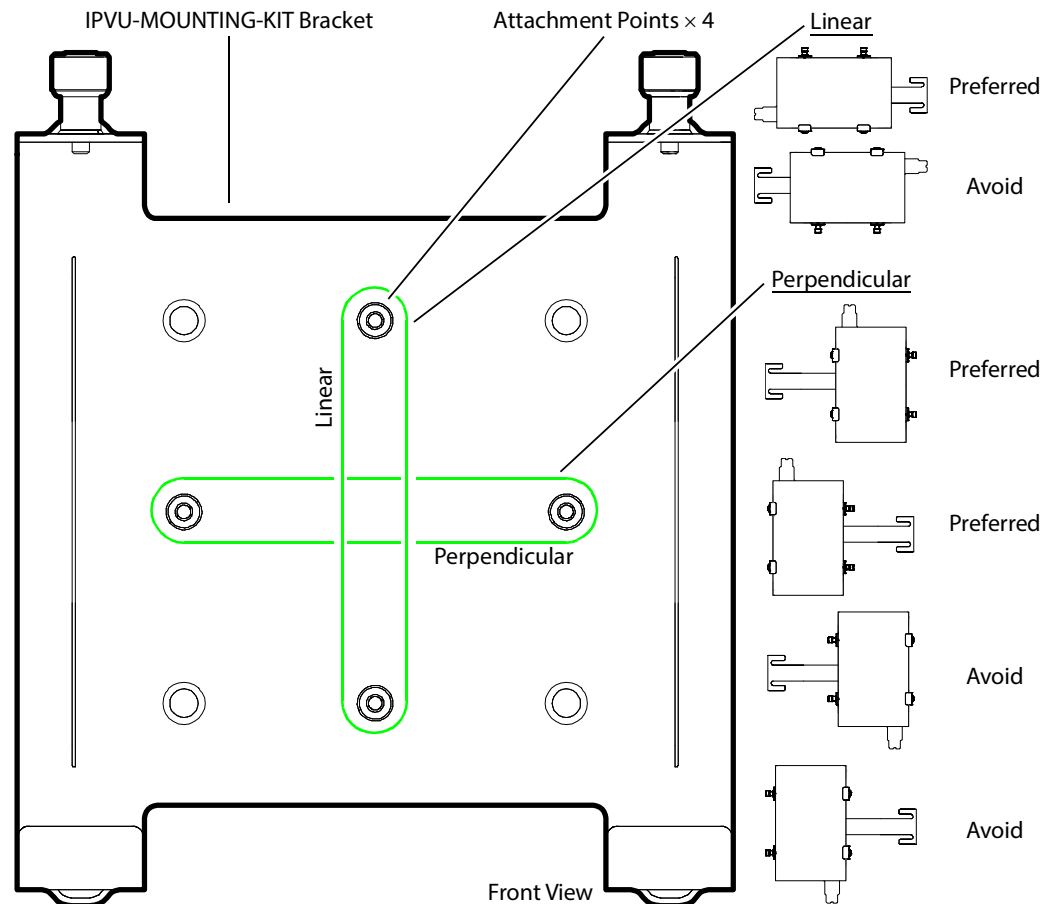

Fig. 3-13: Wall-mounted monitor attachment points that determine the IPVU's orientation

Mounting an IPVU onto a VESA 75mm or 100mm Stand-Mounted Monitor

The IPVU-MOUNTING-KIT can be used with a VESA 75mm or 100mm stand-mounted monitor that is 31 inches or smaller.

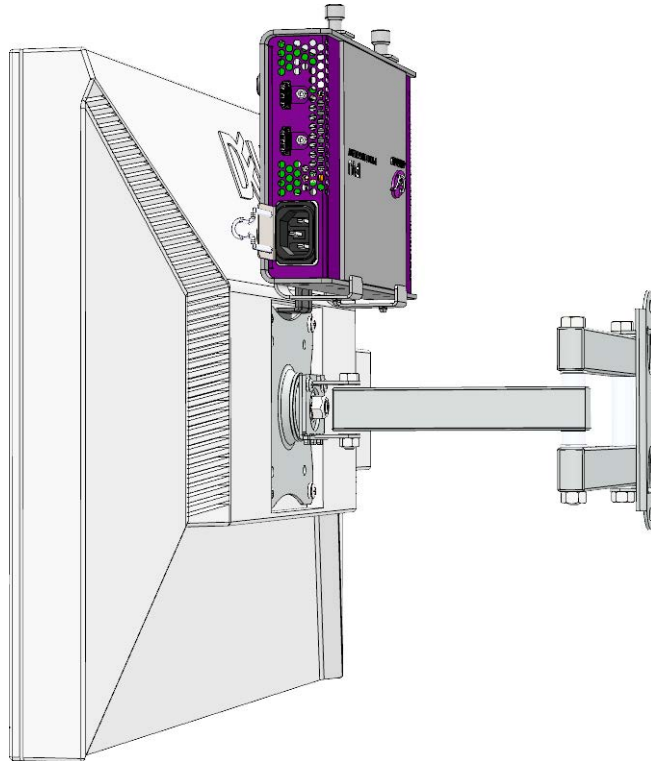

Fig. 3-14: IPVU-MOUNTING-KIT for VESA stand-mounted monitors

When mounting the IPVU behind a monitor, operate the monitor for 30 minutes and then feel the rear housing with your hand. Avoid mounting the IPVU behind the monitor in areas where the monitor is warm to the touch and above these warm spots.

When mounting an IPVU on to the monitor's support bracket with the IPVU-MOUNTING-KIT, the optimal mounting positions are shown below. Note that the IPVU's faceplate is facing away from the monitor.

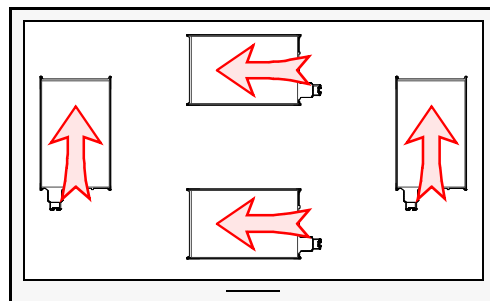

Fig. 3-15: Optimal IPVU mounting positions when located behind a VESA-mount monitor.

To install an IPVU with a VESA-Mount Monitor

This procedure assumes that the monitor has already been attached to a VESA mount monitor stand.

- 1 Use two screws to assemble the IPVU-MOUNTING-KIT as shown below. Set the IPVU's mounting orientation; see [IPVU Mounting Orientation for a Stand-Mounted Monitor](#), on page 46.

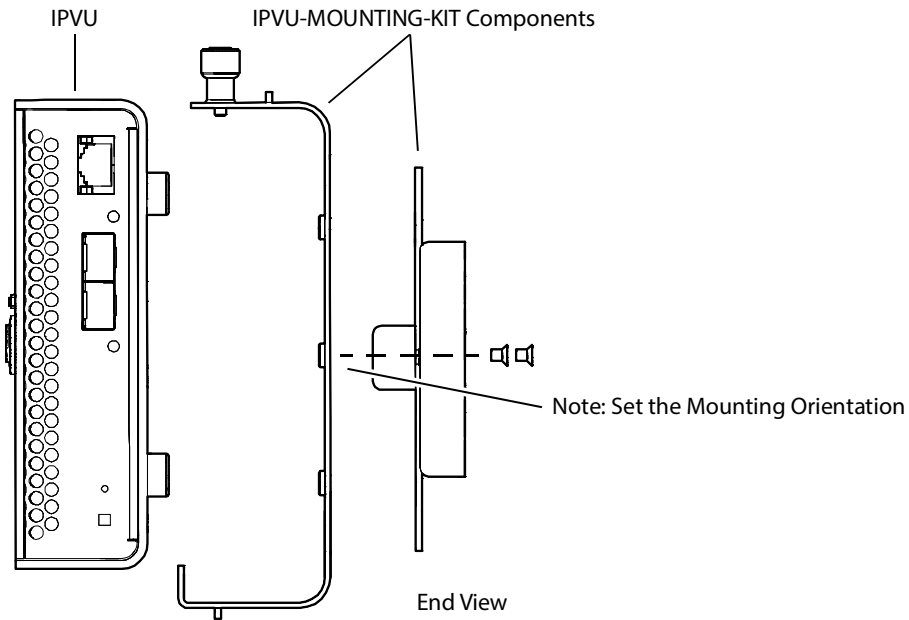

Fig. 3-16: Assemble the IPVU-MOUNTING-KIT for use with a wall-mounted monitor

- 2 Take the monitor off the VESA mount monitor stand.
 - Disconnect any cables.
 - Remove the four screws that attach the monitor to the VESA mount monitor stand.

- 3 Sandwich the IPVU-MOUNTING-KIT between the monitor and the VESA mount monitor stand.

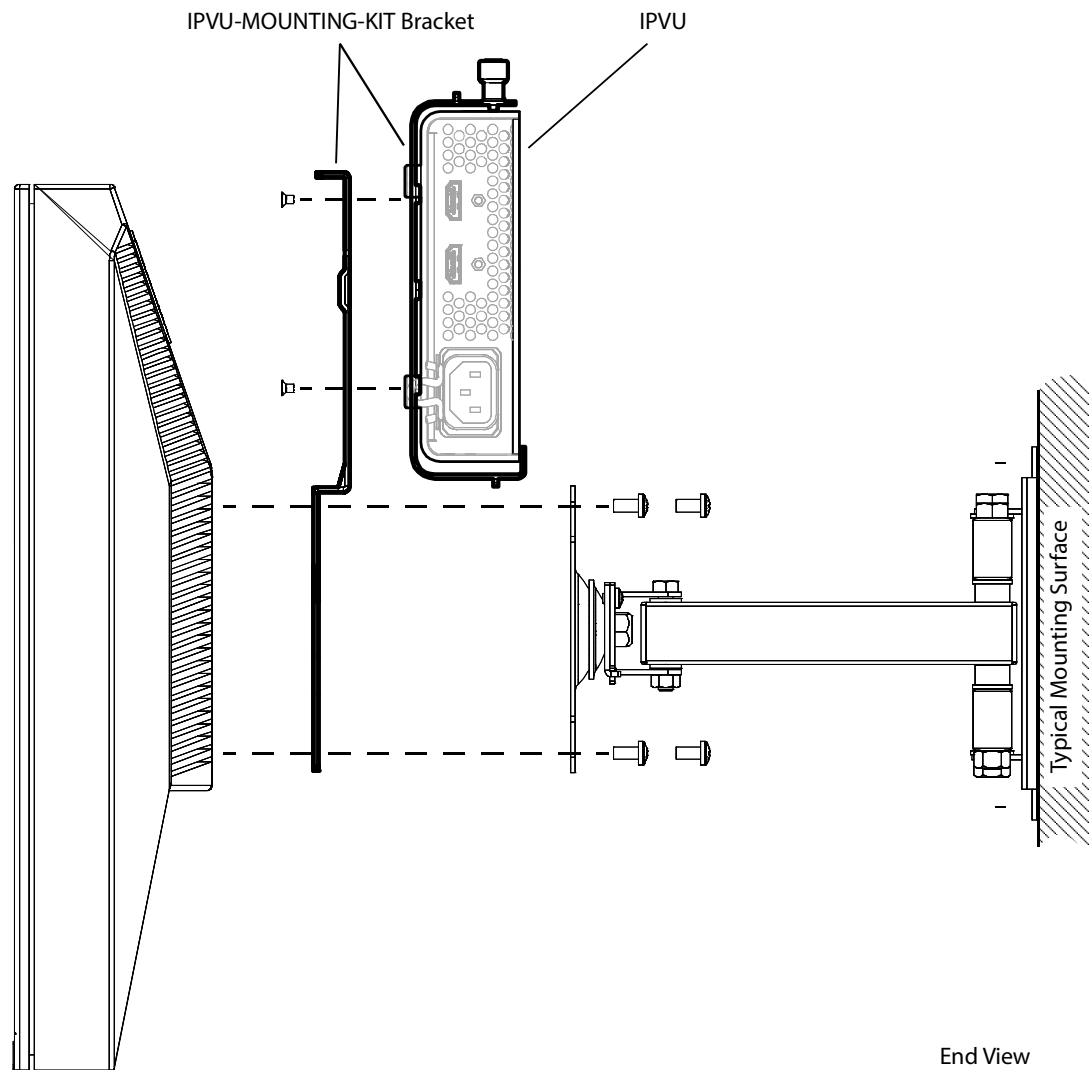

Fig. 3-17: Attaching the IPVU-MOUNTING-KIT to the VESA mount monitor stand

- 4 Replace the four screws that attach the monitor to the VESA mount monitor stand.
- 5 Install the IPVU into the IPVU-MOUNTING-KIT bracket. See [Installing the IPVU into the IPVU-MOUNTING-KIT](#), on page 38.
- 6 Connect all cables to the IPVU. See [Connecting the IPVU](#), on page 48.
- 7 Reconnect power to the monitor.

IPVU Mounting Orientation for a Stand-Mounted Monitor

The IPVU can be attached to the IPVU-MOUNTING-KIT bracket in either of two *Perpendicular* orientations. This choice is made during the assembly of the IPVU-MOUNTING-KIT bracket by choosing the appropriate set of attachment points, as shown below.

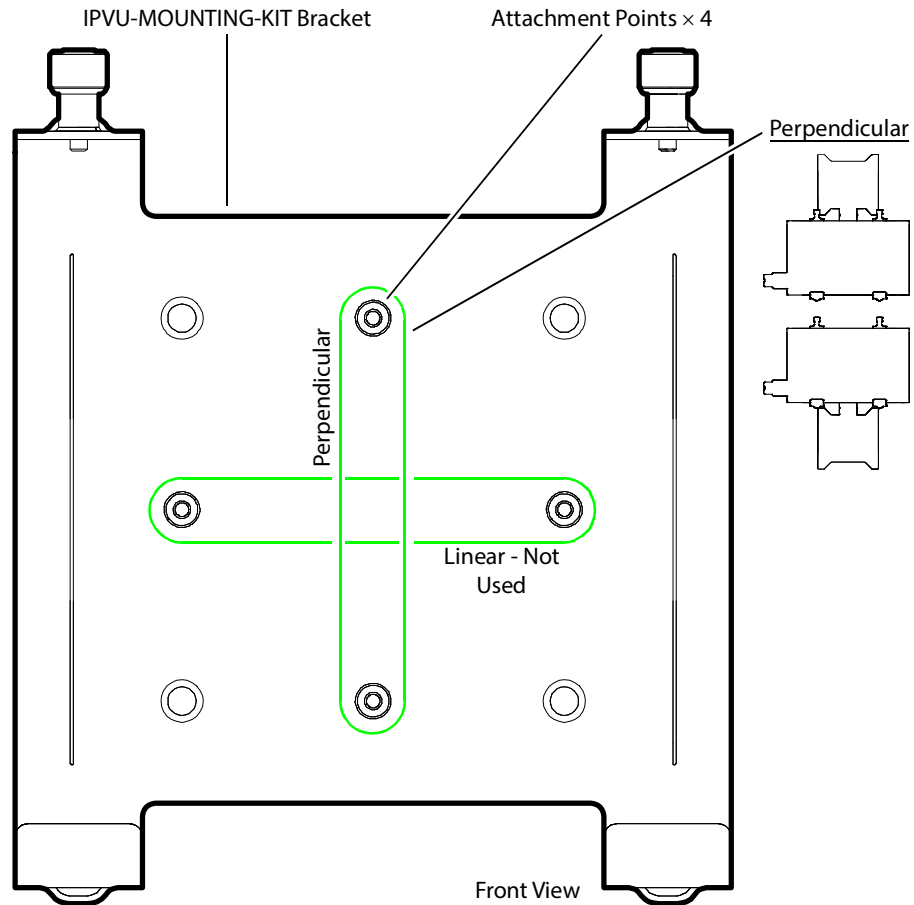

Fig. 3-18: Stand-mounted monitor attachment points that determine the IPVU's orientation

Securing the IPVU-MOUNTING-KIT with Fastener Points

If none of the previous IPVU-MOUNTING-KIT mounting methods work, you can use the IPVU-MOUNTING-KIT's fastener points to secure the IPVU in place with nylon cable ties. These same fastener points can also be used to secure cables in place for any installation where the IPVU-MOUNTING-KIT is used (see Figure 3-20).

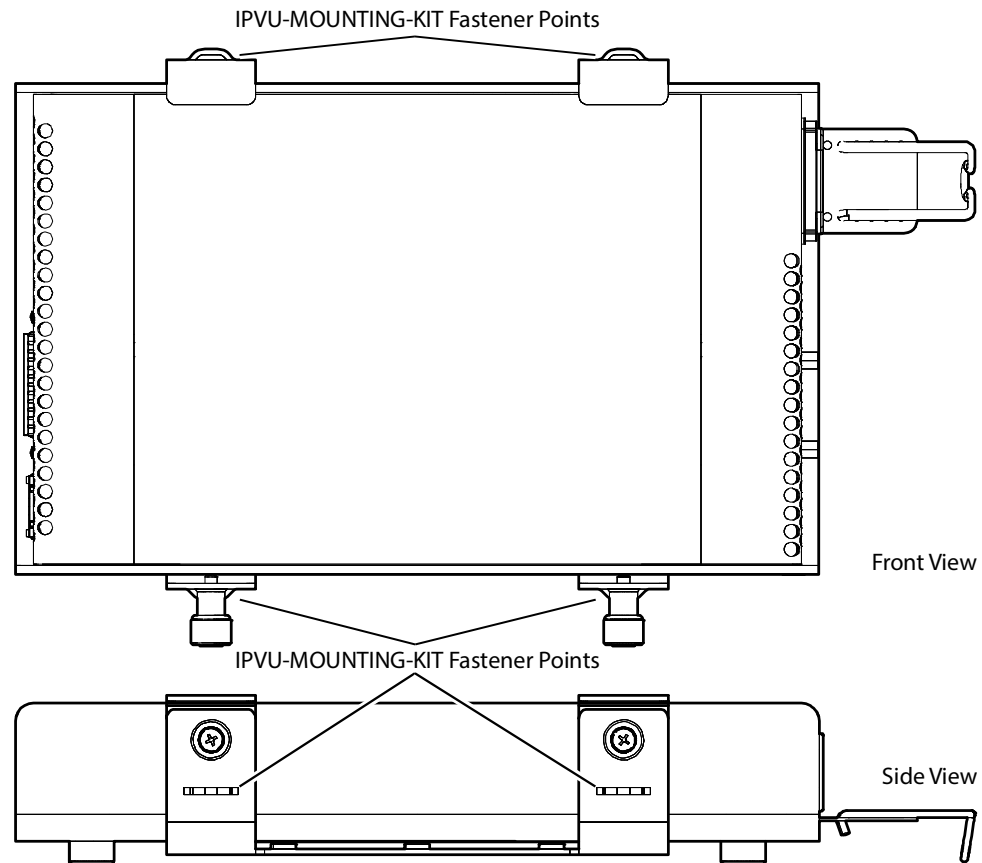
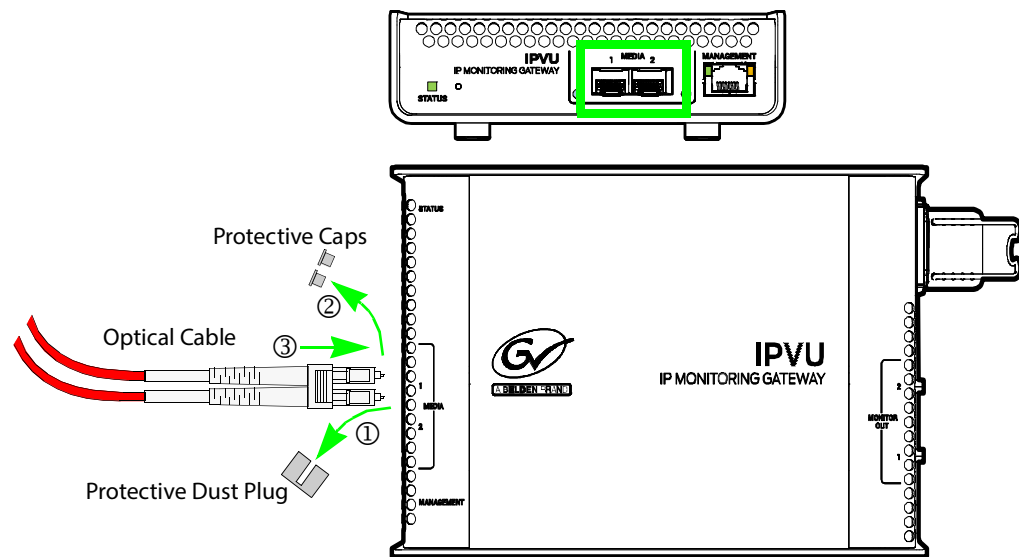

Fig. 3-19: IPVU-MOUNTING-KIT fastener points

Connecting the IPVU

Use field-supplied OM4 Multimode Fiber (MMF) single fiber optical cable fitted with SC connectors with the IPVU. For an installation overview, see [Cabling Diagrams](#), on page 27. Proceed as follows:

- 1 Insert the SFP cartridge(s) into the IPVU: see [Installing the SFP Ethernet Module](#), on page 113.
- 2 Connect the optical cable from the switch to the IPVU: first remove the protective caps from the receiver's optical input port and from the optical cable, then insert the optical cable connector into the IPVU's optical port **MEDIA 1**. If SMPTE 2022-7 is being used, repeat for the IPVU's optical port **MEDIA 2**.



Note: The SFP module's optical ports cannot be cleaned.

If dust enters the SFP module's optical port to the point where performance degrades, the corrective action is to replace the damaged SFP module with a new one.

Store the protective caps in a sealed container. Keep them safe for future use.

Use these protective caps whenever you disconnect the optical cable:

- Insert a dust plug into the empty SFP module's optical port.
- Install caps on the open end of the fiber optic cable.

See [Keep Fiber Connections Clean](#), on page 108 for important maintenance information about fiber optic connections.

- 3 Connect the management network to the IPVU: connect the Cat5 cable from the management switch to the IPVU's **MANAGEMENT** port.

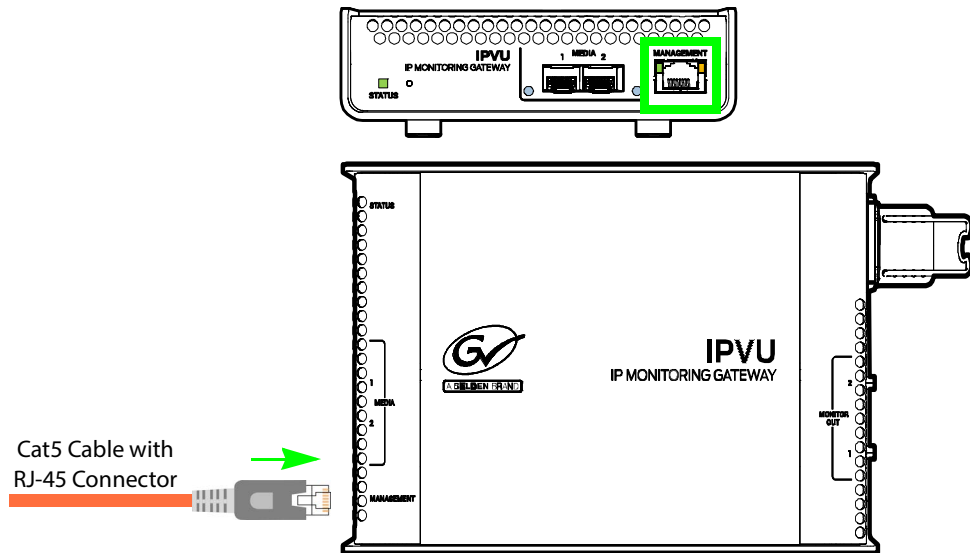

- 4 Connect a standard monitor cable with type A connectors to the IPVU's **MONITOR OUT 1** port. Then connect the other end of the monitor cable to the Monitor's Digital Input. If a second monitor is to be used, connect it to the IPVU's **MONITOR OUT 2** port.

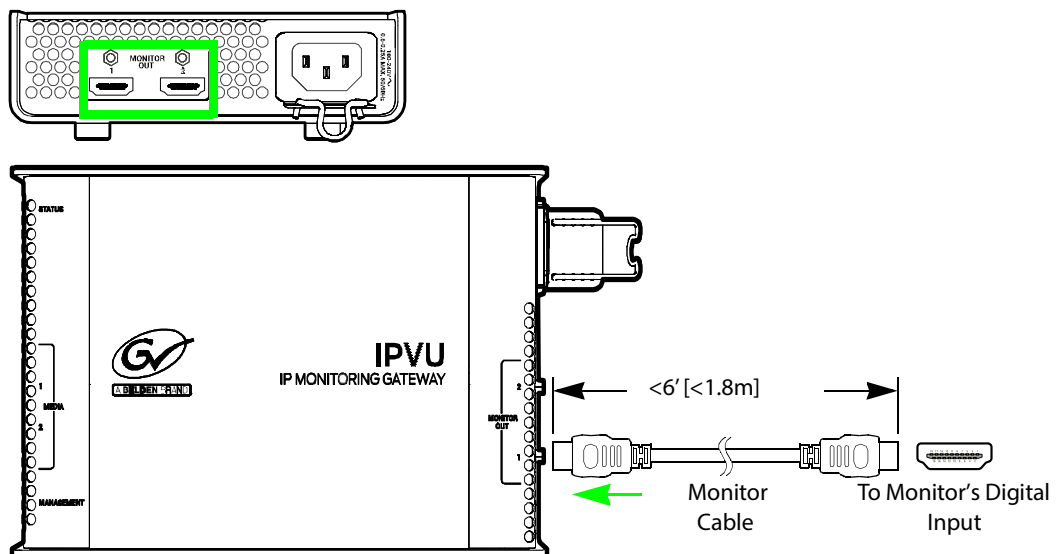

- 5 If locking monitor cables are used (see [Locking Monitor Outputs](#), on page 31), tighten screw-lock pin on the cables to mechanically secure the cables to the IPVU.

- 6 Connect a IEC 60320 C13 power cord to the IPVU's AC input port. Plug the other end into an AC outlet (mains). Ensure the **STATUS** indicator lights up. Should you disconnect power from the IPVU, see [Power Cycling an IPVU](#), on page 101.

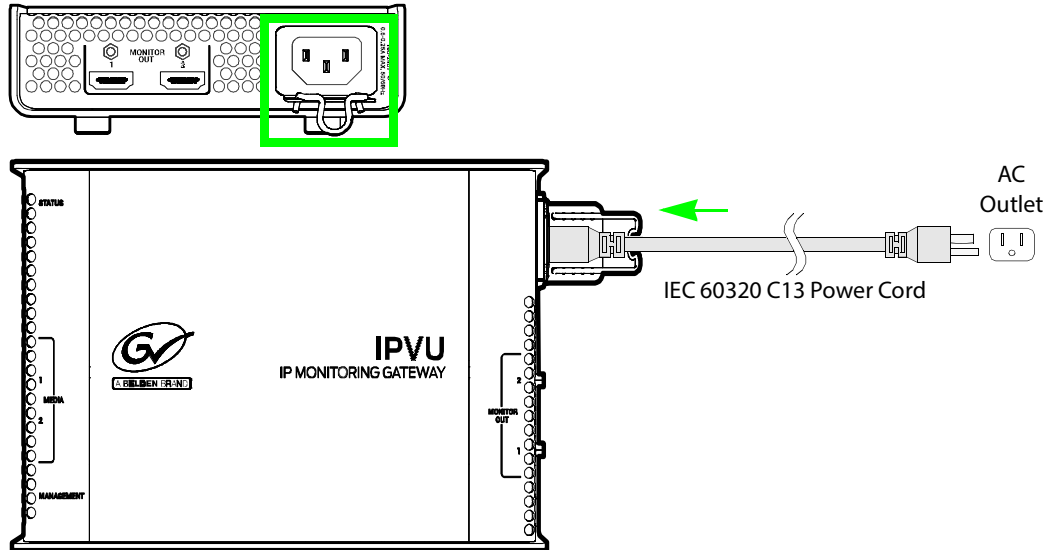

- 7 Prevent power cord pull-out by adjusting the position of the AC power cord retainer clip so that the power cord plug is firmly held into the socket. Then clip it onto the power cord. Test it by gently pulling on the power cord's plug (do not pull on the cable).

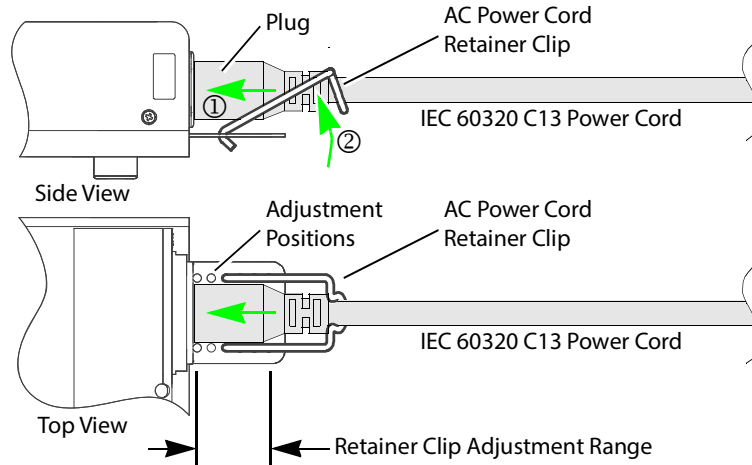

- 8 Use field-supplied nylon cable ties to bundle up excess cable lengths and to make a clean installation. The IPVU-MOUNTING-KIT has four fastener points that can be used to secure cables in place (see also [Securing the IPVU-MOUNTING-KIT with Fastener Points](#), on page 47). Do not fully tighten the nylon cable ties in order to prevent damage to the optical cable by crushing or kinking the cable.

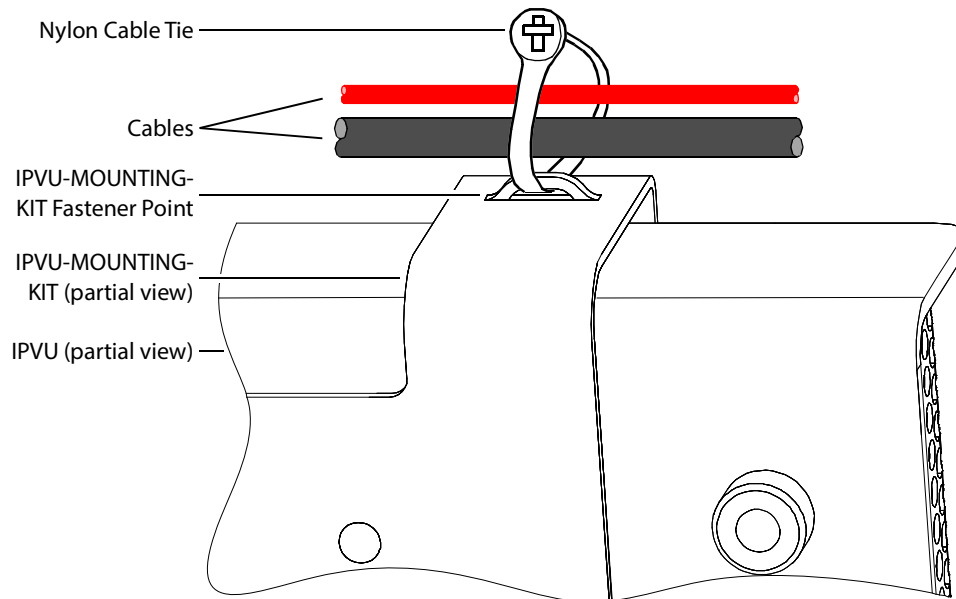

Fig. 3-20: Using the IPVU-MOUNTING-KIT's fastener points to make a clean installation

4 IPVU Commissioning and Configuration

IPVU Commissioning and Configuration is done with RollCall software.

Factory Default IP Address and Network Port Usage

The factory default management IP address for the IPVU is **192.168.3.31**.

To set the IP configuration, see [Ethernet Gb](#), on page 98.

Certain ports must be open on the management network. This information can be found under **Port Usage** in the *RollCall V4 Suite & RollCall Lite Installation Guide*. See [Related Documentation](#), on page 19.

Installing RollCall

To install RollCall, see the *RollCall V4 Suite & RollCall Lite Installation Guide*. See [Related Documentation](#), on page 19.

For help with general use of the RollCall application, open the user manual by clicking the  button on the main RollCall toolbar.

Firmware Upgrade

The firmware in the IPVU can be upgraded in the field. We strongly recommend to upgrade the IPVU with the latest firmware for the latest feature and stability enhancements. See [Upgrading the IPVU's Firmware](#), on page 102.

Terminology Used with RollCall

Term	Description
Essence	A general term used to describe an SDI component; Video, Audio and Data are all essences.
Spigot	Generic term for a Source or Destination.
Flow	Sequence of RTP packets of a single essence.
Source	Originator of one or more flows, i.e. a set of one or more sender spigots.
Destination	Receiver of one or more flows, i.e. a set of one or more receiver spigots.

Navigating Pages in the RollCall Template

The RollCall template has a number of pages, each of which can be selected from the drop-down list at the top left of the display area. Right-clicking anywhere on the pages will also open a page view list, allowing quick access to any of the pages.

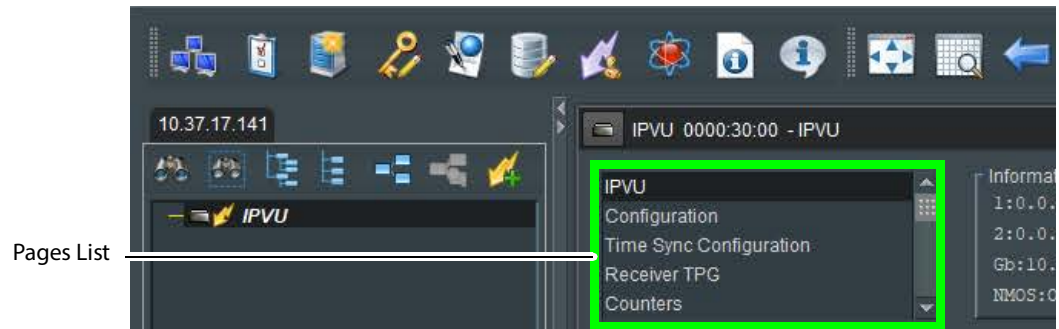

Fig. 4-1: Template Pages

Template Pages

The following pages are available:

- [IPVU](#), on page 56.
- [Configuration](#), on page 61.
- [Time Sync Configuration](#), on page 63.
- [Receiver TPG \(Test Pattern Generator\)](#), on page 65.
- [Counters](#), on page 66.
- [FEC](#), on page 67.
- [NMOS](#), on page 68.
- [Ethernet Pages 1 and 2](#), on page 70.
- [Ethernet 1 and 2 RTP Receiver](#), on page 71.
- [Ethernet RTP Receiver Video Stats](#), on page 72.
- [Ethernet RTP Receiver Audio Stats](#), on page 73.
- [Audio V Fade](#), on page 74.
- [Input Loss Control](#), on page 74.
- [Spigot 1 to 8](#), on page 75.
- [Logging - Configuration](#), on page 79.
- [Logging - System](#), on page 80.
- [Logging - Network](#), on page 83.
- [Logging - Network - 1G](#), on page 86
- [Logging - SFP](#), on page 88.
- [Logging - FPGA](#), on page 91.
- [Logging - Spigot 1 to 8](#), on page 92.
- [Logging - NMOS](#), on page 93.
- [Logging - Card Diagnostics](#), on page 95.

- [Setup](#), on page 97.
- [Ethernet Gb](#), on page 98.
- [Interop](#), on page 99.
- [SFP Configuration](#), on page 100.

Setting Values

Many of the settings within the templates have values, either alpha or numeric.

When setting a value in a field, the value, whether text or a number, must be set by pressing the **Enter** key, or clicking the **S Save Value** button.

Clicking an associated **P Preset Value** button returns the value to the factory default setting.

Information Display

The **Information** display pane appears at the top of each page, and shows basic information on the input, standard and status for the IPVU. The information to be displayed is defined on the **Video Selection** and **Information Select** panes to the right of the **Information** display.

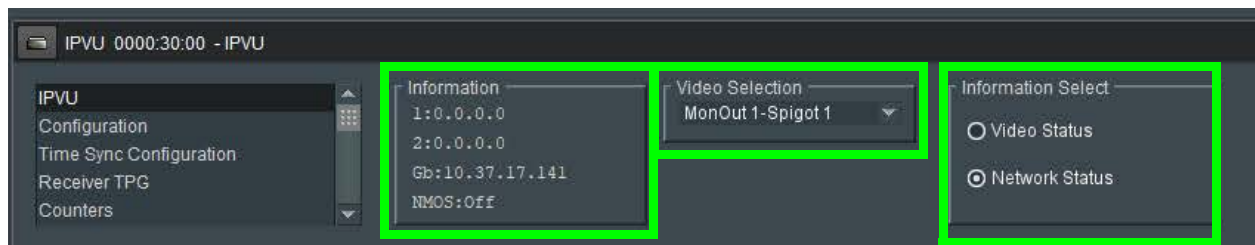

Fig. 4-2: Information and Video Selection Panes

Selecting the Information to Display

The following selected information will be displayed on the **Information** display pane.

- Select the **MonOut 1/2** to display data for from the **Video Selection** drop-down list. **MonOut 1** represents the IPVU's **MONITOR OUT 1** connection and **MonOut 2** represents the IPVU's **MONITOR OUT 2** connection. See [Electrical Connections, Reset Pushbutton, and Status Indicators](#), on page 29.
- Select **Video Status** or **Network Status** from the **Information Select** pane as required.

IPVU

The IPVU page allows basic parameters to be set.

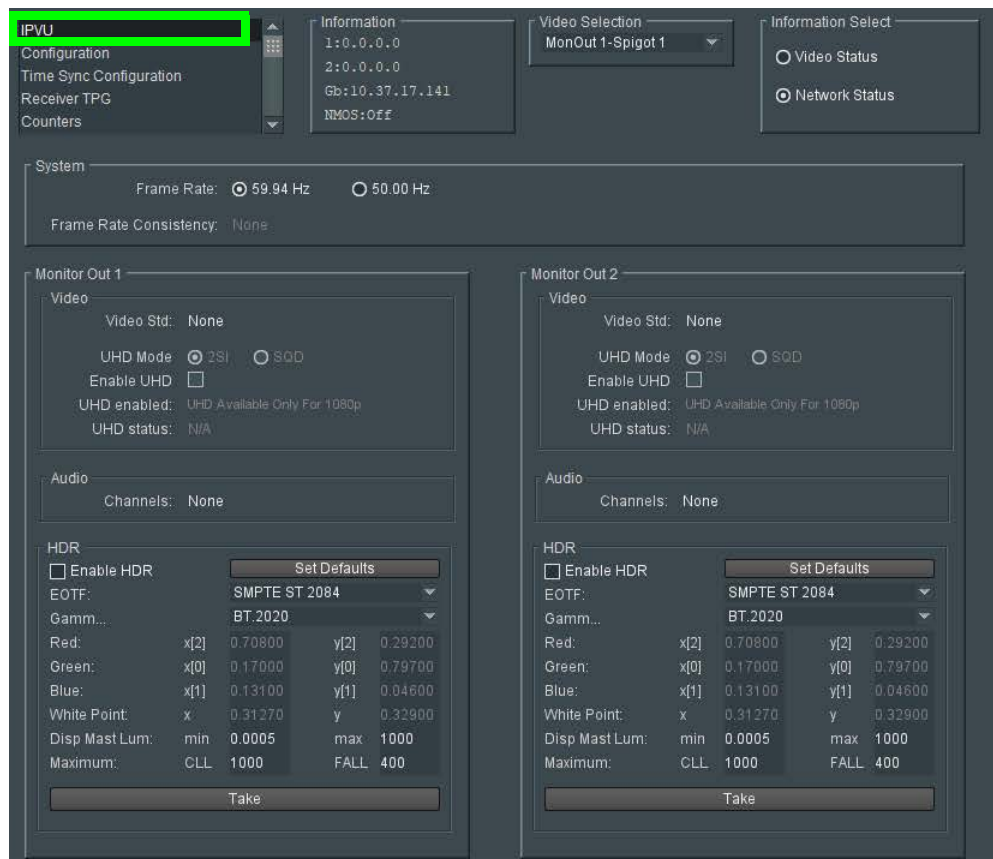

Fig. 4-3: IPVU Configuration Page

Parameter	Description
Frame Rate	Set the system frame rate frequency.
Frame Rate Consistency	Show if there is a mismatch between the incoming video stream and the system frame rate.
Video Std	Shows the current video stream's resolution and frame rate frequency that has been set. To set this value, see Video Std in Spigot Page Overview , on page 76.
UHD Mode	When Enable UHD (below) is set, set the inputs stream's UHD mode: <ul style="list-style-type: none"> • 2SI: The input stream conforms to the ST425-5 format (2-sample interleave). • SQD: The input stream conforms to the "Square Division" legacy format: refer to annex "B" of SMPTE ST 452-5. See Configuring the Stream Inputs for use with 4K UHD SQD, on page 58. <p>Note: JPEG-XS video streams cannot be used with any of these modes.</p>

Parameter	Description
Enable UHD	Enables UHDTV format support: single Image with payload up to 12 Gb/s, carried on 4 links. When enabled, set the UHD Mode above. This option logically links the four streams together so that they are switched together at once ensuring that there is no switching delay between the streams that would create visible glitches.
UHD enabled	Shows whether video stream resolution currently being sent on Monitor Out 1 /2 is 4K UHD. See Electrical Connections, Reset Pushbutton, and Status Indicators , on page 29.
UHD status	Confirms that all 4 links are coherent between each other and with the format expected by the IPVU.
Channels	Shows the number of audio channel streams currently being sent on MONITOR OUT 1 /2 . See Electrical Connections, Reset Pushbutton, and Status Indicators , on page 29.
Enable HDR	Enables High Dynamic Range (HDR) insertion of static metadata into the MONITOR OUT 1 /2 stream. See Configuring HDR , on page 59 for more information.

Configuring 4K UHD Two-Sample Interleave Division for use with an IPVU Device

To support 4K UHD streams, the image is mapped onto four HD sub-images using a Two-Sample Interleave division (2SI). This means each of the four sub-stream carries a quarter-resolution picture. These four sub-streams must be logically linked together so that they are switched together at once ensuring that there is no switching delay between the four streams that would create visible glitches. Each **MONITOR OUTPUT** head can be individually configured to use 2SI or not. See [Electrical Connections, Reset Pushbutton, and Status Indicators](#), on page 29.

The following shows the typical video stream composition of a two-sample interleave division display.

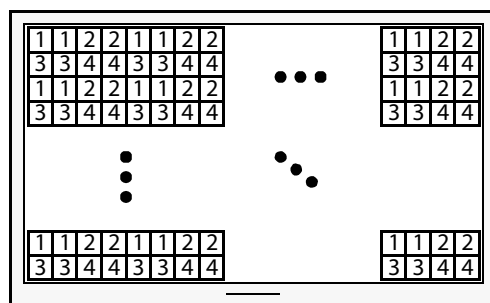

4K UHD Composite Image

- 1: SMPTE ST 424-5 Link 1 pixels
- 2: SMPTE ST 424-5 Link 2 pixels
- 3: SMPTE ST 424-5 Link 3 pixels
- 4: SMPTE ST 424-5 Link 4 pixels

PREREQUISITES:

- Configure each of the four IPVU spigots that are to receive the four HD sub-images (Link 1, Link 2, Link3, and Link 4). See [Spigot 1 to 8](#), on page 75. See [Spigot use](#)

According to [IPVU Output Resolution](#), on page 75 to know which spigots are to receive link inputs for a given **MONITOR OUTPUT** head.

To configure a 4K UHD Two-Sample Interleave Division for a monitor output

- 1 Open the IPVU page. See [IPVU](#), on page 56.
- 2 For the **Monitor Output 1** and **2** that is to show 4K UHD, set **Enable UHD**.
- 3 For the **Monitor Output 1** and **2** that is to show 4K UHD, set **UHD Mode** to **2SI**.

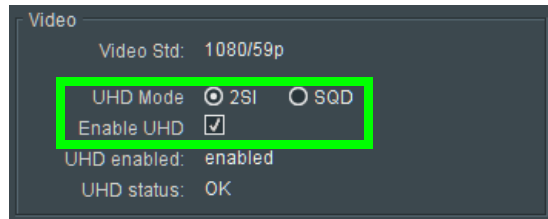

UHD enabled becomes **enabled** and **UDH status** becomes **OK**.

Configuring the Stream Inputs for use with 4K UHD SQD

To support 4K UHD streams, a quad-link (square division) configuration can be used. That is, the 4K UHD image is divided into four HD quadrants, and each quadrant is sent as four separate streams. These four streams must be logically linked together so that they are switched together at once ensuring that there is no switching delay between the four streams that would create visible glitches between the four quadrants. Each **MONITOR OUTPUT** head can be individually configured to use SQD or not. See [Electrical Connections, Reset Pushbutton, and Status Indicators](#), on page 29.

The following shows the typical video stream composition of a 4K UHD quad-link display.

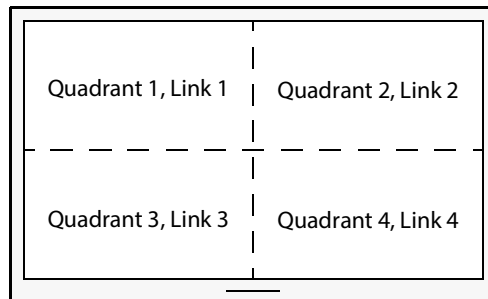

4K UHD Composite Image

PREREQUISITES:

- Configure each of the four IPVU spigots that are to receive the four quad-link images (Link 1, Link 2, Link3, and Link 4). See [Spigot 1 to 8](#), on page 75. See [Spigot use According to IPVU Output Resolution](#), on page 75 to know which spigots are to receive link inputs for a given **MONITOR OUTPUT** head.

To configure a 4K UHD Two-Sample Interleave Division for a monitor output

- 1 Open the IPVU page. See [IPVU](#), on page 56.
- 2 For the **Monitor Output 1** and **2** that is to show 4K UHD, set **Enable UHD**.

- For the **Monitor Output 1** and **2** that is to show 4K UHD, set **UHD Mode** to **SQD**.

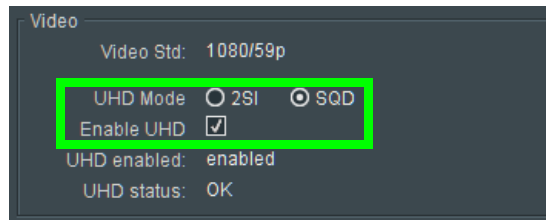

UHD enabled becomes **enabled** and **UDH status** becomes **OK**.

Configuring HDR

The HDR parameter determines which HDR standard should be used by each of the IPVU's **MONITOR OUTPUT** heads to interpret the input signal's format.

To configure HDR for a monitor output

- Open the IPVU page. See [IPVU](#), on page 56.
- For the **Monitor Output 1** and **2** that is to show an HDR signal, set **Enable HDR**. See [Electrical Connections, Reset Pushbutton, and Status Indicators](#), on page 29.

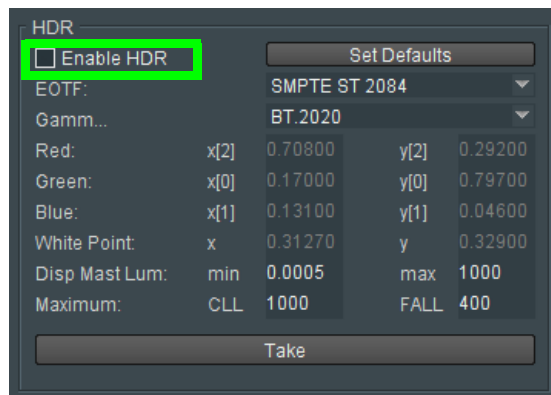

- For the **Monitor Output 1** and **2** that is to show HDR, set the HDR configuration parameters.

Parameter	Description
Enable HDR	Enables High Dynamic Range (HDR) processing.
Set Defaults	Set the HDR metadata to its default value.
EOTF	Set the Electro-Optical Transfer Function (EOTF) for the input signal: <ul style="list-style-type: none"> Trad gam - SDR Lum: the HD input video signal meets the Rec. 709 standard. SMPTE ST 2084: the Perceptual Quantizer input video signal meets the SMPTE ST 2084 standard. HLG - BT.2100: the Hybrid Log-Gamma input video signal meets the BT.2100 standard.

Parameter	Description
Gamut	Set the gamut correction transfer functions for the input signal: <ul style="list-style-type: none"> • BT.709: the input video signal's color gamut meets the Rec. 709 standard. • BT.2020: the input video signal's color gamut meets the Rec. 2020 standard.
Red: x[2] / y[2]	According to the EOTF and Gamut settings above, this shows the calculated RGB and white point values for information purposes. Your monitor may have a color settings menu where this information can be used to adjust the screen.
Green: x[0] / y[0]	
Blue: x[1] / y[1]	
White Point: x / y	
Disp Mast Lum: min / max	The nominal minimum and maximum display luminance of the mastering display. min : The nominal minimum display luminance of the mastering display, as configured for the mastering process. This is represented in candelas per square meter (cd/m ²). The value must be a multiple of 0.0001 candelas per square meter. max : The nominal maximum display luminance of the mastering display, as configured for the mastering process. This is represented in candelas per square meter (cd/m ²). The value must be a multiple of 1 candela per square meter.
Maximum: CLL / FALL	These parameters must be set if you expect that any PQ video stream may be received. Set the HDR metadata: MaxCLL : Maximum Content Light Level (MaxCLL) corresponds to the brightest pixel to be expected in the stream. This is represented in nits. The value 0 is internally interpreted as 1000. MaxFALL : Maximum Frame-Average Light Level (MaxFALL) corresponds to the highest average brightness per frame expected in the entire stream. This is represented in nits. The value 0 is internally interpreted as 1000.

4 Click **Take** to apply the settings.

Configuration

The **Configuration** page allows basic IPVU parameters to be set.

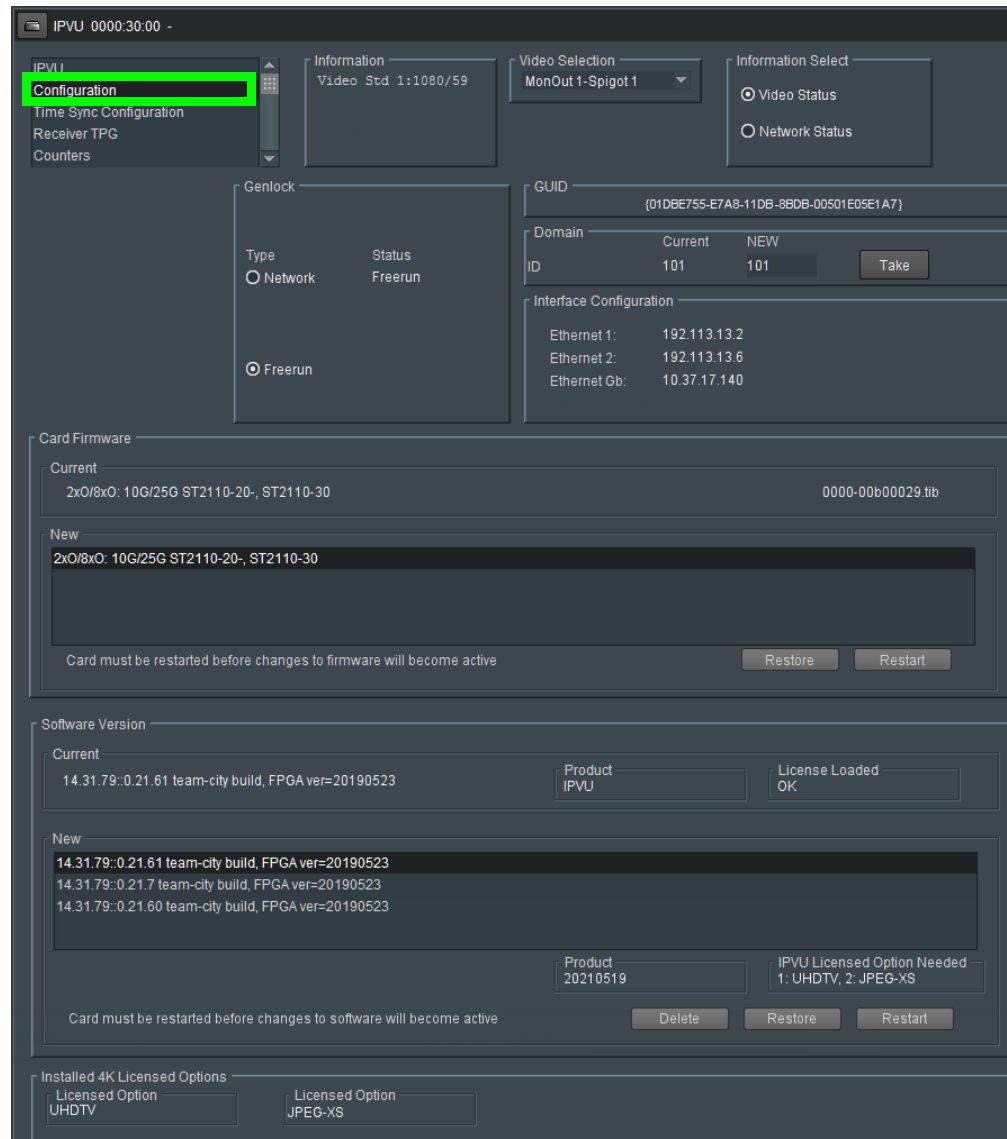

Fig. 4-4: Configuration Page

Parameter	Description
Genlock	Select Genlock type: <ul style="list-style-type: none"> Network - use the network's PTP clock. Freerun - Card is using its own clock with no reference to any other source.
Status	The current genlock status: NO LOCK / LOCKED / Freerun.
GUID	Displays the absolute unique identifier associated with the IPVU.

Parameter	Description
Domain	RollCall+ uses domains to partition a network; only nodes on the same domain can communicate with one another. A domain is uniquely identified with a number and a friendly name/alias. Set an ID as required, then press Take to confirm the change.
Interface Configuration	Displays the IP address for each of the Ethernet interfaces. Ethernet 1 represents the IPVU's MEDIA 1 connection, Ethernet 2 represents the IPVU's MEDIA 2 connection, and Ethernet Gb represents the IPVU's MANAGEMENT connection. See Electrical Connections, Reset Pushbutton, and Status Indicators , on page 29.
Card Firmware/Software Version	Each software version contains multiple firmware images. These allow different spigot input/output and flow standard combinations to be selected. Select the required software from the Software Version pane, then select the firmware which provides the required combination of inputs, outputs and flow standards from the list displayed on the Firmware pane. Note: Restore and Restart buttons are displayed only when an item not currently installed is selected. Click Take to restart the IPVU and implement any changes made.
Installed 4K Licensed Options	Licensed Option: Shows the currently-installed software license options. UHDTV: Support for 4K UHD output resolution. JPEG-XS: Support for JPEG-XS compliant compressed source video signals.

Time Sync Configuration

The **Time Sync Configuration** page allows selection of the source to be used for synchronizing flows, and configuration of any properties associated with the relevant source.

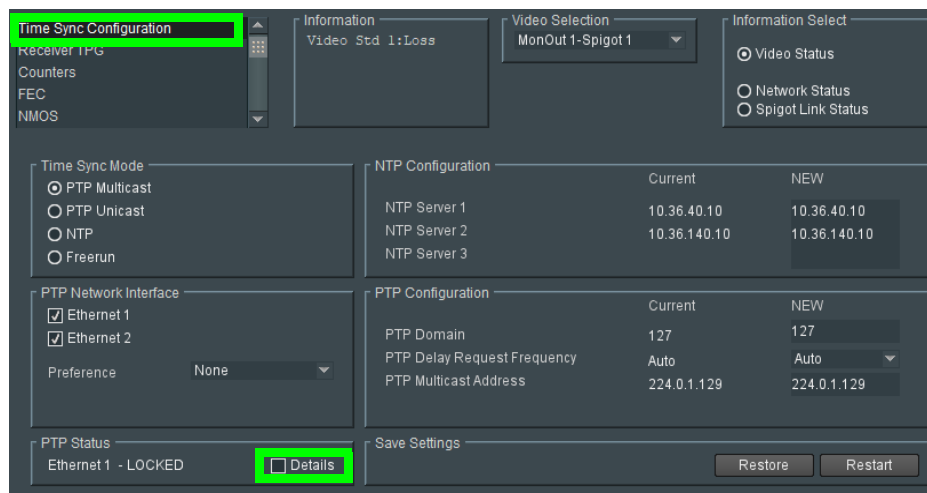

Fig. 4-5: Time Sync Configuration Page

Parameter	Description
Time Sync Mode	Click a radio button to select the required mode. Note that the PTP options require a grandmaster clock to be present in the system.
NTP Configuration	To add an NTP server, enter the server's IP address in to the New field.
PTP Network Interface	<p>Click check boxes to select the required network interfaces. If an interface fails, the next enabled interface on the list will be switched to automatically.</p> <p>Ethernet 1: represents the IPVU's MEDIA 1 connection. Ethernet 2: represents the IPVU's MEDIA 2 connection.</p> <p>The Preference pulldown sets the primary interface to use. If the primary interface fails, the alternate interface (if enabled) will be switched to automatically.</p> <ul style="list-style-type: none"> • None: PTP will fail over from one to the next in the absence of sync messages. Once failed over, it shall remain on that port until it fails over again. • Ethernet 1: If Ethernet 1 is available, it has priority. Thus, if there is a failover from Ethernet 1 to Ethernet 2, as soon as Ethernet 1 becomes available again, it will switch back to Ethernet 1. • Ethernet 2: as per Ethernet 1 but for Ethernet 2. <p>See Electrical Connections, Reset Pushbutton, and Status Indicators, on page 29.</p>

Parameter	Description
PTP Configuration	Select values from the PTP Domain and PTP Delay Request Frequency drop-down lists, as required. Type the appropriate IP address into the PTP Multicast Address field.
Show Status	Check the Show Status checkbox to display status and histogram information. See Status , on page 64 and Histogram , on page 65.
Save Settings	Displayed only if settings on this page are changed. Clicking Restore will discard the changes, while clicking Restart will implement the changes and reboot the IPVU.

Status

When the **Show Status** checkbox is set (see above), this displays important system status information in a single convenient panel.

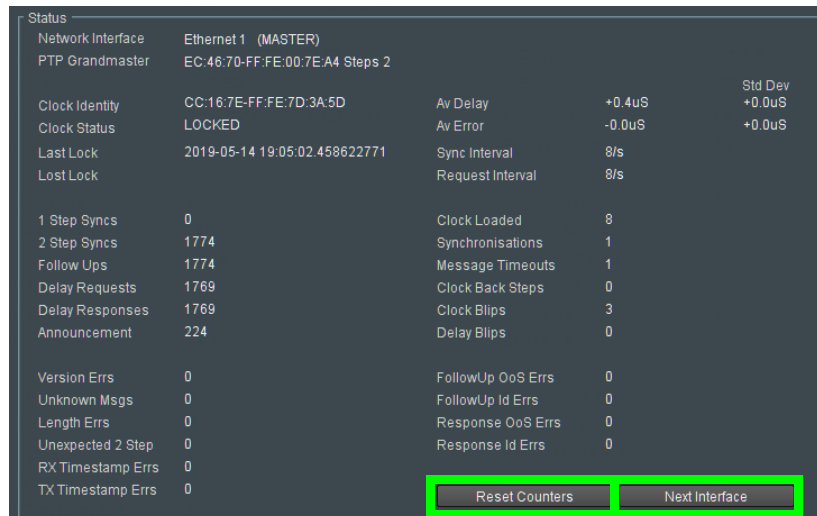

Fig. 4-6: Time Sync Status

Parameter	Description
Reset Counters	Clear the accumulated data.
Next Interface	Cycle through the available Ethernet interface. Ethernet 1 represents the IPVU's MEDIA 1 connection, Ethernet 2 represents the IPVU's MEDIA 2 connection, and Ethernet Gb represents the IPVU's MANAGEMENT connection. See Electrical Connections, Reset Pushbutton, and Status Indicators , on page 29.

Histogram

When the **Show Status** checkbox is set (see above), located to the right of the **Status** panel, the Histogram provides a graphical representation of the distribution of differences between the card's clock and the PTP grandmaster clock. Every time the clock difference is recalculated, the relevant bar is incremented. A correctly functioning system will show a distinct peak around the 0ns level.

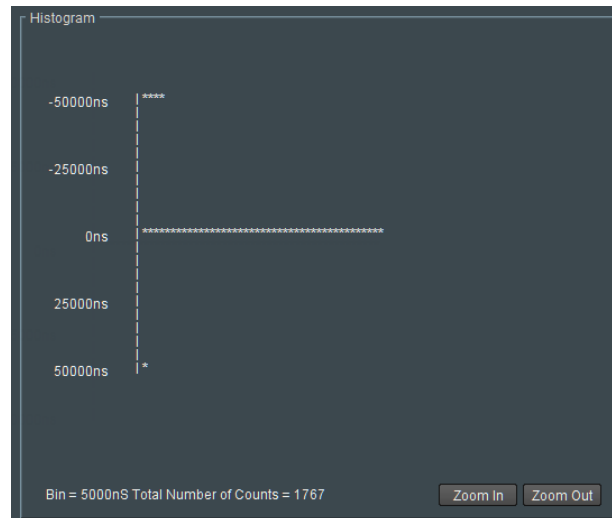

Fig. 4-7: Time Sync Status Information - Histogram

Receiver TPG (Test Pattern Generator)

The TPG page allows test patterns to be applied on a spigot-by-spigot basis.

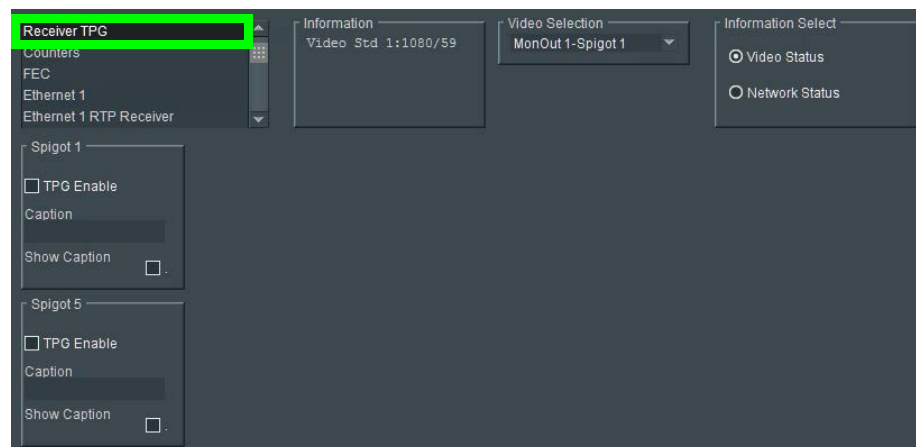

Fig. 4-8: TPG Page

The following options are available for each spigot:

Parameter	Description
TPG Enable	Display a test pattern at MONITOR OUT 1 / 2 . Spigot 1 represents the IPVU's MONITOR OUT 1 connection and Spigot 5 represents the IPVU's MONITOR OUT 2 connection. See Electrical Connections, Reset Pushbutton, and Status Indicators , on page 29.
Caption	Type a caption (max 19 characters) to optionally be displayed with the test pattern.
Show Caption	Enable the checkbox to display the caption with the test pattern.

If a test pattern is applied, the spigot cannot be used for streaming any other essence.
The caption generator allows a caption to be overlaid on the video essence.

Counters

The **Counters** page allows the various counters provided to be cleared down.

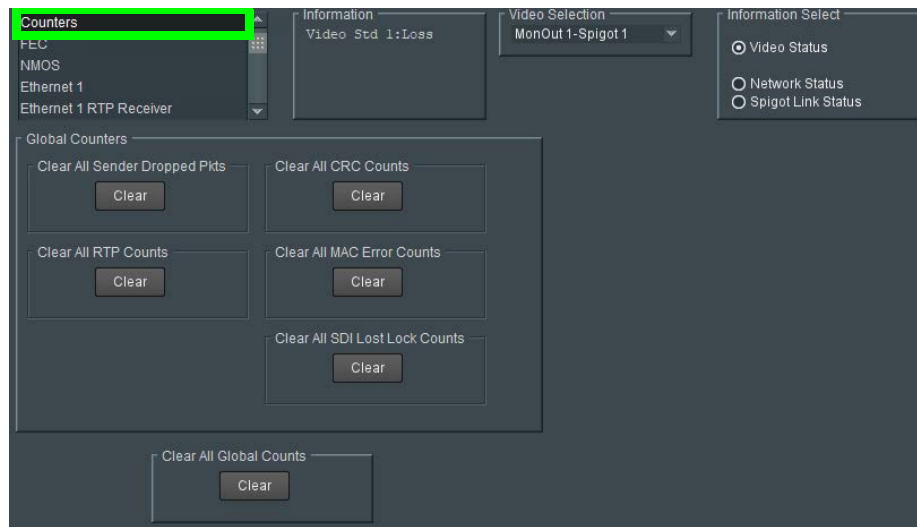

Fig. 4-9: Counters Page

Click **Clear** buttons as required.

FEC

The **FEC** page allows FEC Clause 74 to be selected and FEC logging to be activated, if required. FEC stats are also available.

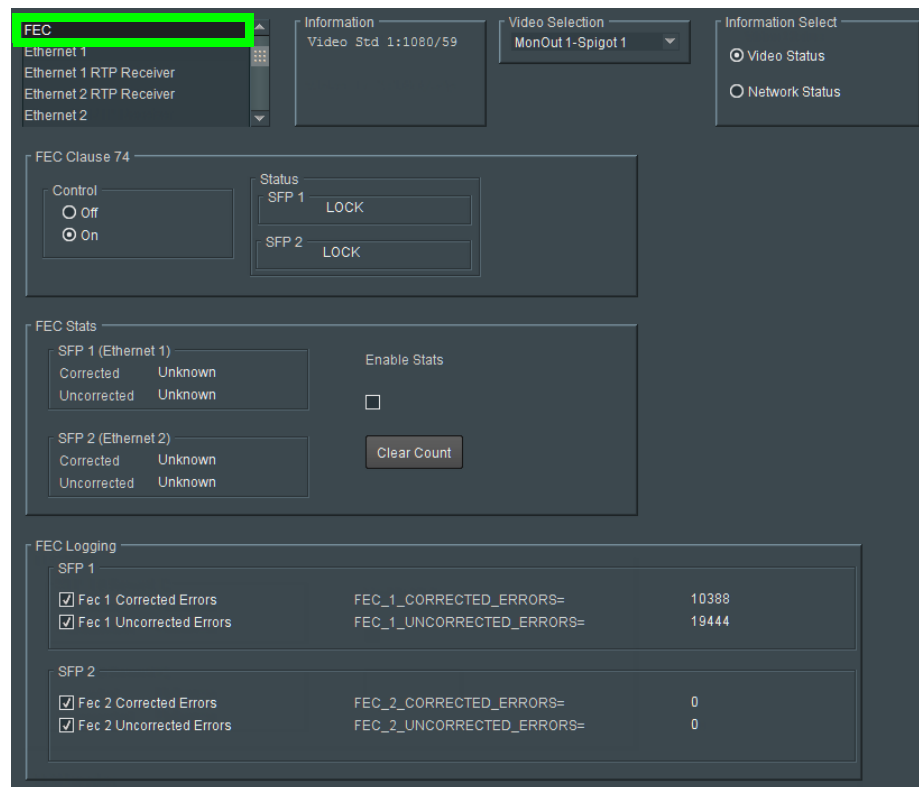

Fig. 4-10: FEC Page

SFP 1 represents the IPVU's **MEDIA 1** connection and **SFP 2** represents the IPVU's **MEDIA 2** connection. See [Electrical Connections, Reset Pushbutton, and Status Indicators](#), on page 29.

Parameter	Description
FEC Clause 74	Allows low-latency FEC Clause 74 error correction to be used. Options are: <ul style="list-style-type: none"> • On • Off
Status	Displays lock status for each SFP.
FEC Stats	Displays the number of corrected and uncorrected errors received via the SFPs. Click Enable Stats to activate, and Clear Count to zero the counters.
FEC Logging	Information on several parameters can be made available to a logging device connected to the RollCall network. Enable check boxes to activate log fields as required. Available log fields are shown in the table below.

Log Field	Description
FEC CORRECTED ERRORS	Number of corrected errors for FEC <i>N</i> .
FEC UNCORRECTED ERRORS	Number of uncorrected errors for FEC <i>N</i> .

Where *N* is the SFP number.

NMOS

The **NMOS** page allows various NMOS parameters to be set, allowing the IPVU to inter-operate with other equipment through an NMOS registry.

IPVU supports Networked Media Open Specifications (NMOS) AMWA IS-04 for device discovery and registration and IS-05 for connection management. Furthermore, it supports AMWA BCP-002 recommendations for Grouping NMOS Resources.

IPVU relies on an external NMOS registry that is used to register NMOS devices. You must point the IPVU to this external NMOS registry.

PREREQUISITE:

- A working NMOS registry service must be available on the network.
- Entries for your NMOS registries have been added to the network DNS server. This enables automatic DNS-SD discovery. Contact your IT department to do so. Otherwise you can manually specify the registry to connect to.

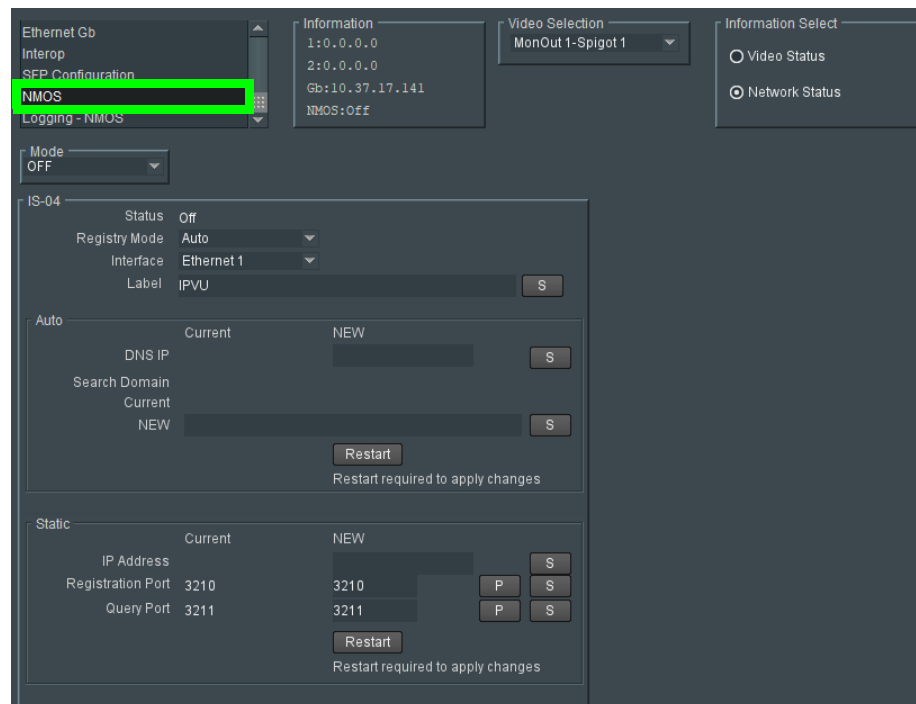

Fig. 4-11: NMOS Page

Parameter	Description
Mode	<p>Set the NMOS operating mode:</p> <p>OFF: disable NMOS. This is the default.</p> <p>IS-04: enable the Networked Media Open Specifications (NMOS) IS-04 v1.2 or higher for device discovery and registration. Receivers are updated as a result.</p> <p>IS-04 & IS-05: enable the NMOS IS-04 for device discovery and registration and IS-05 for connection management. Receivers will accept routing request and process the received SDP file.</p>
Status	<p>When the NMOS node registers successfully to NMOS registry service, the status shows a message indicating that it has registered to the IP address, registry port number, and query port number of that NMOS registry service. For example, the message Registered to 10.37.19.115:4041 Query:4041 indicates a successful registration. Whereas, when it fails to register then the status will simply show the message Not registred.</p>
Registry Mode	<p>Set the IS-04, registry connection mode:</p> <p>Auto: automatic discovery of the NMOS registry using DNS Service Discovery (DNS-SD), as described in AMWA IS-04 NMOS Discovery and Registration Specification v1.2.</p> <p>Static: manually specified NMOS registry values for address, registration port and query port.</p>
Interface	<p>Select the network interface to be used to connect to the NMOS registry.</p> <p>Ethernet 1 represents the IPVU's MEDIA 1 connection, Ethernet 2 represents the IPVU's MEDIA 2 connection, and Ethernet Gb represents the IPVU's MANAGEMENT connection. See Electrical Connections, Reset Pushbutton, and Status Indicators, on page 29.</p>
Label	<p>Set the identifier by which this IPVU will be known in the NMOS registry, and by extension, to other NMOS devices using this NMOS registry.</p>
Auto / DNS IP	<p>Set the IP address of the network DNS server providing the DNS Service Discovery (DNS-SD) to allow the automatic discovery of the NMOS registry when the Registry Mode is set to Auto.</p>
Auto / Search domain, Current	<p>The network's domain name on which the IPVU will search for NMOS devices and the NMOS registry when the Registry Mode is set to Auto.</p>
Auto / Search domain, New	<p>Set a new search domain on which the IPVU will search for NMOS devices and the NMOS registry when the Registry Mode is set to Auto.</p>
Static / IP Address	<p>Set the NMOS registry's IP Address when the Registry Mode is set to Static.</p>
Static / Registration Port	<p>Set the NMOS registry's registration port number when the, Registry Mode is Static. The default Registry Port value is 3210.</p>

Parameter	Description
Static / Query Port	Set the NMOS registry's query port number when the Registry Mode is Static . The default Query Port value is 3211.
Restart	Click to apply your new settings.

Ethernet Pages 1 and 2

Note: Ethernet pages 1 & 2 refer to the **MDEIA 1 & 2 SFP Ethernet** connections only. See [Ethernet Gb](#), on page 98 for information on the **MANAGEMENT Ethernet** connection. See also [Electrical Connections, Reset Pushbutton, and Status Indicators](#), on page 29.

The **Ethernet** pages show details and status for each **MEDIA** network interface. The IPVU defaults to use DHCP, but this can be overridden and a static IP address defined if required.

The screenshot shows the 'Ethernet 1' configuration page. At the top, there are tabs for 'Ethernet 1', 'Ethernet 1 RTP Receiver', 'Ethernet 2 RTP Receiver', and 'Ethernet 2 RTP Receiver Video Stats'. The 'Ethernet 1' tab is selected. Below the tabs, there are sections for 'Information' (Video Std: 1:1080/59), 'Video Selection' (MonOut 1-Spigot 1), and 'Information Select' (Video Status, Network Status). The main configuration area includes fields for 'Rear - SFP 1', 'Current' and 'New Static' IP Address (192.113.13.2), Default Gateway (192.113.13.1), Subnet Mask (255.255.255.240), and MAC Address (00:50:1E:05:E1:A8). The mode is set to 'STATIC'. There are 'S' buttons for saving each field. A 'New Mode' section has radio buttons for 'DHCP' and 'Static', with 'Static' selected. A 'Restart' button is present. Below this is a 'Clear Link Change Count' button and a note: 'NOTE: DHCP / static takes effect on restart'. The 'Link Change Time' is 2019-06-19T03:52:40 and the 'Link Change Count' is 1. The 'Switch LLDP Info' section shows Name: RnD_9236C, ID: CC:16:7E:7D:3A:8E, Port ID: Ethernet1/13/1, and Port VLAN: -. The 'All Traffic' section shows a table with columns: Capacity Gb/s, Actual (Mb/s), Used %, Free %, and Enable Stats. The 'CPU Traffic' section shows a table with columns: Sent and Received. The 'All Traffic' table has the following data:

	Capacity Gb/s	Actual (Mb/s)	Used %	Free %	Enable Stats
Sender	25	0.00	0.00	100.00	<input type="checkbox"/>
Receiver	25	10389.13	41.56	58.44	

The 'CPU Traffic' table has the following data:

	Sent	Received
Total Unicast Packets	21	9
Total Broadcast Packets	3	2
Total Multicast Packets	84	827
Total Bytes	38372	380185
Bytes / sec	458	916

Fig. 4-12: Ethernet 1 Page

The Ethernet Pane

The **Ethernet** pane displays details of the currently selected network interface, and allows a static IP address to be defined. Enter information as required, then click **S** to save. New settings are applied when **Restart** is clicked.

Clear Link Change Count

If the state of the Ethernet link changes, the **Link Change Count** and **Link Change Time** fields are updated. Click **Clear Link Change Count** to reset the **Link Change Count** to zero.

Switch LLDP Info

Displays LLDP information received from the switch that the IPVU is connected to.

The All Traffic/CPU Traffic Panes

Click the **Enable Stats** check box to display information on traffic passing through the IPVU.

Ethernet 1 and 2 RTP Receiver

The **RTP Receiver** pages display the amount of data received, plus details of packet loss, on a spigot-by-spigot basis. Units are megabits per second.

Click **Enable Stats** to display values; click **Clear RTP Count** or **Clear Error Count** to zero RTP Sequence Discontinuity or Error counters.

The screenshot shows the 'Ethernet 1 RTP Receiver' page. The sidebar on the left has 'Ethernet 1 RTP Receiver' highlighted. The top navigation bar includes 'Information' (Video Std 1:1080/59), 'Video Selection' (MonOut 1-Spigot 1), and 'Information Select' (Video Status selected, Network Status unselected). The main content area is split into two sections:

- RTP Receiver:**
 - Total Received RTP Rate (Mbs): Unknown
 - Total Received RTP Pkt Rate: Unknown
 - RTP Sequence Discontinuity Count: Unknown
 - Mac Error Count: Unknown
 - Buttons: 'Clear RTP Count', 'Clear Error Count', and 'Enable Stats' (checkbox).
- Unwanted Multicast Traffic:**
 - Multicast Drop Rate (Mbs): Unknown
 - Multicast Drop Pkt Rate: Unknown
 - Last Few Dropped Packets table:

Source IP	Source Port	Destination IP	Destination Port	Packet Type
Unknown	Unknown	Unknown	Unknown	Unknown
Unknown	Unknown	Unknown	Unknown	Unknown
Unknown	Unknown	Unknown	Unknown	Unknown
Unknown	Unknown	Unknown	Unknown	Unknown
Unknown	Unknown	Unknown	Unknown	Unknown
Unknown	Unknown	Unknown	Unknown	Unknown
Unknown	Unknown	Unknown	Unknown	Unknown
Unknown	Unknown	Unknown	Unknown	Unknown

Fig. 4-13: Ethernet 1 & 2 RTP Receiver Page

Ethernet RTP Receiver Video Stats

The **Ethernet RTP Receiver Video Stats** page displays information on the data received via RTP on each Ethernet input. Units are megabits per second. Click **Enable Stats** to display values; click **Clear All RTP Counts** to zero RTP Discontinuity counters for each Ethernet input.

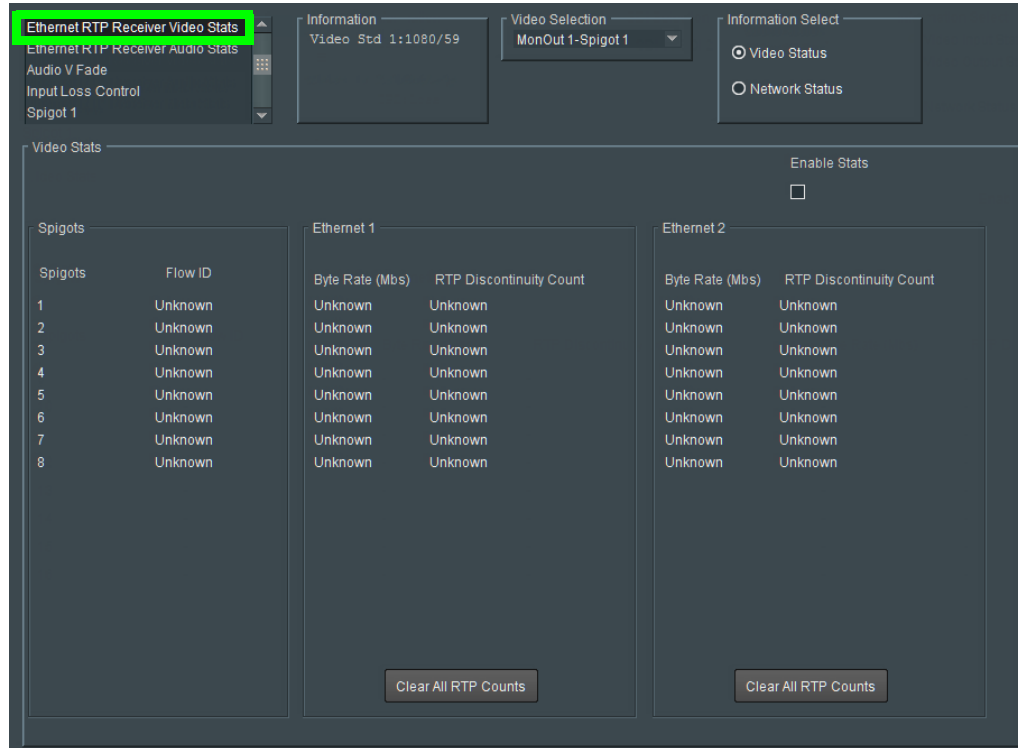

Fig. 4-14: Ethernet RTP Receiver Video Stats Page

Spigots represents a single stream IP receiver.

Ethernet 1 represents the IPVU's **MEDIA 1** connection and **Ethernet 2** represents the IPVU's **MEDIA 2** connection. See [Electrical Connections](#), [Reset Pushbutton](#), and [Status Indicators](#), on page 29.

Ethernet RTP Receiver Audio Stats

The **Ethernet RTP Receiver Audio Stats** page displays information on the data received via RTP on each Ethernet input. Units are megabits per second. Click **Enable Stats** to display values; click **Clear All RTP Counts** to zero RTP Discontinuity counters for each Ethernet input.

Fig. 4-15: Ethernet RTP Receiver Audio Stats Page

Spigots represents a single stream IP receiver.

Ethernet 1 represents the IPVU's **MEDIA 1** connection and **Ethernet 2** represents the IPVU's **MEDIA 2** connection. See [Electrical Connections, Reset Pushbutton, and Status Indicators](#), on page 29.

Each spigot can have up to 4 audio flows of AES67 audio channels.

Audio V Fade

The Audio V Fade template configures an audio V-fade for each video input IP stream (for example, at receiving, destination spigots). When the video input switches to another, an audio V-fade can be used to reduced audio disturbances at the switch-over.



Fig. 4-16: Typical Audio V Fade Page

Enable check boxes to activate log fields as required.

Log Field	Description
Enable	Select to enable audio V-fade on IPVU inputs.

Spigot 1 represents the IPVU's **MONITOR OUT 1** connection and **Spigot 5** represents the IPVU's **MONITOR OUT 2** connection. See [Electrical Connections, Reset Pushbutton, and Status Indicators](#), on page 29.

Input Loss Control

The Input Loss Control template configures which video signal to show on the IPVU's **MONITOR** output when the input stream is lost.

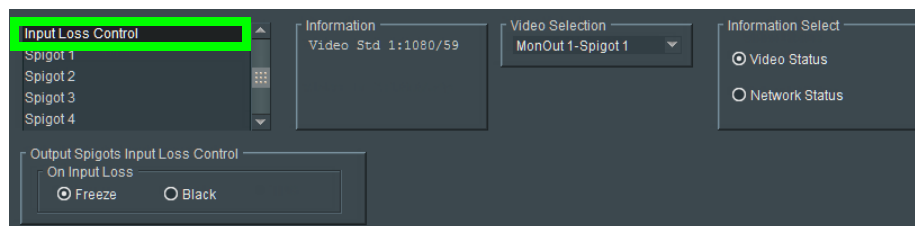

Fig. 4-17: Typical Input Loss Control Page

Log Field	Description
On Input Loss	Freeze: Select to freeze video. Black: Select to use video black.

Spigot 1 to 8

Spigot use According to IPVU Output Resolution

An IPVU device has 8 input spigots. They are used according to the IPVU's output resolution.

Input Spigot Number	HD Output Description	4K UHD Output Description
Spigot1	Stream input for Monitor Output 1 connection	First HD input stream for Monitor Output 1 output connection
Spigot2	Not used	Second HD input stream for Monitor Output 1 output connection
Spigot3	Not used	Third HD input stream for Monitor Output 1 output connection
Spigot4	Not used	Fourth HD input stream for Monitor Output 1 output connection
Spigot5	Stream input for Monitor Output 2 connection	First HD input stream for Monitor Output 2 output connection
Spigot6	Not used	Second HD input stream for Monitor Output 2 output connection
Spigot7	Not used	Third HD input stream for Monitor Output 2 output connection
Spigot8	Not used	Fourth HD input stream for Monitor Output 2 output connection

See [Electrical Connections, Reset Pushbutton, and Status Indicators](#), on page 29.

Spigot Page Overview

A separate page is provided for each of the active output spigots, **Spigot1** to **Spigot8**.

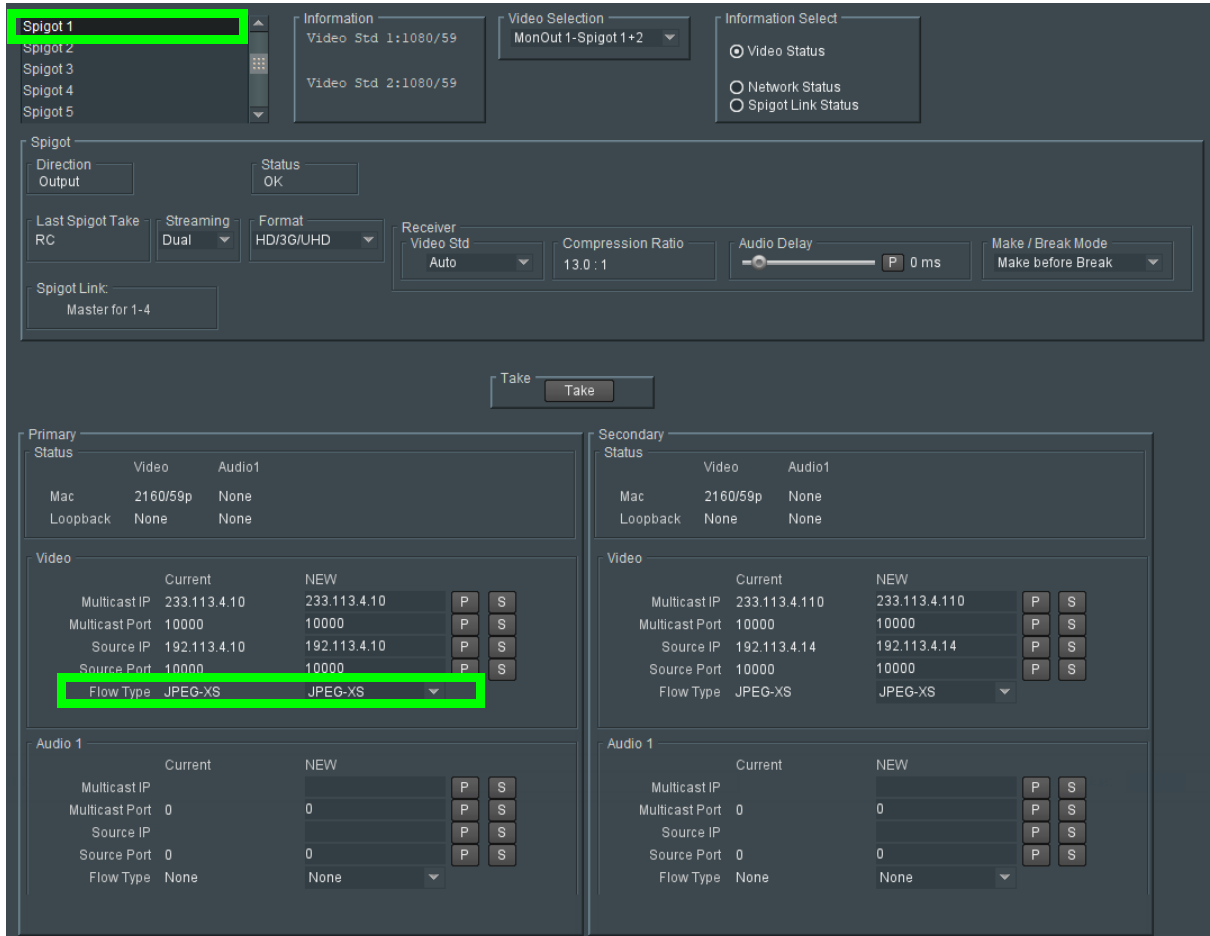

Fig. 4-18: Typical Output Spigot Page

Parameter	Description
Spigot pane	The Spigot pane provides basic configuration for the selected Spigot. Click Take to apply any changes made in this pane.
Direction	Displays spigot direction. Output: This spigot is a receiver. The IPVU is a receiver only.
Status	Current spigot's status.
Last Spigot Take	The last Take performed on the spigot and how it was made, for example, through RollCall or an external agent such as VSM.

Parameter	Description
Streaming	<p>Set the Ethernet connectors to use for this spigot. This will also determine the bandwidth to be used. Options are:</p> <ul style="list-style-type: none"> • Dual: Full redundancy to support SMPTE ST 2022-7, both Primary (SFP1) and Secondary (SFP2) Ethernet connectors are used. All bandwidth of both Ethernet connectors are used. See Cabling to Support SMPTE 2022-7 with an IPVU, on page 27. To support redundancy, you must set the Flow Type to 2110-20 for both the primary and secondary ports for the Video essences. • A: Primary (MEDIA 1) Ethernet connector only, and so half of the available bandwidth. • B: Secondary (MEDIA 2) Ethernet connector only, and so half of the available bandwidth. <p>See Electrical Connections, Reset Pushbutton, and Status Indicators, on page 29 for SFP / connector locations.</p>
Format	Select the format to be used on this spigot. This will ensure that the appropriate level of bandwidth is allocated for the stream.
Receiver / Video Std	Select the standard for the incoming video.
Receiver / Num Audio Chans	For SMPTE ST 2110 streams only ^a : Select the actual number of audio channels present on this spigot (up to 32 channels). Though you can select up to 32 channels in the pull down, only the first 2 audio channels are available at the Monitor Out 1 or Monitor Out 2 output connections. Auto mode only works if the source stream uses an extended header. In Auto mode, only the first 2 audio channels are available at the Monitor Out 1 or Monitor Out 2 output connections. See Electrical Connections, Reset Pushbutton, and Status Indicators , on page 29.
Receiver / Compression Ratio	For SMPTE ST 2110-22 JPEG-XS streams only. Shows the current JPEG-XS video compression ratio set by the encoder.
Receiver / Audio Delay	Move the slider to set an Audio Delay as required. Click P to return to the preset default value.
Receiver / Make/Break Mode	Specifies how changes to an output's destination will be made. Make before Break causes the new destination to buffer data before connection to the previous destination is broken; this results in a smoother transition, but requires more bandwidth. Break before Make simply swaps the output's destination without buffering. Select the required mode from the drop-down list.
Spigot Link	When inputs are linked together to support an UHD quad link output, this shows the group of 4 output spigots used for this. See Spigot use According to IPVU Output Resolution , on page 75 to enable UHD inputs. Master X-Y: This is a range of spigots that the above settings apply to. Slaved to X: This is the spigot on which the above settings come from.
Take	Click to apply any changes made to the above parameters.

Parameter	Description
Primary and Secondary Panes	
Flow Panes for Video and Audio	<p>Displays Video and Audio status, and allows multicast IP and port details to be defined for the selected spigot.</p> <p>The Current column shows the present value. To manually set the multicast details for the spigot, set the value in the New column and click S to save the details, or P to return to the preset default value.</p> <p>To set multicast details for the spigot:</p> <ul style="list-style-type: none"> • Enter Multicast IP and Multicast Port details as required. • The multicast address and port can also be managed by external NMOS control. See NNMOS, on page 68. • Enter the appropriate details in the Source IP and Source Port fields. Each spigot can support a variety of flows. • Select the required flow type (audio/video standard) from the Flow Type drop-down list. <p>To support redundancy (SMPTE ST 2022-7), you must set the Flow Type to 2110 for both the primary and secondary ports for the Video essence and set Streaming to Dual. To verify that redundancy is working, see Testing if Network Redundancy (SMPTE ST 2022-7) is Working, on page 107.</p> <ul style="list-style-type: none"> • Video: <ul style="list-style-type: none"> • None • SMPTE2022-6; video essence only. Audio and ancillary essences for this flow type are unsupported. • ST 2110-20 • JPEG-XS; low latency, compressed stream. • Audio: <ul style="list-style-type: none"> • None • ST 2110-30

a. Audio and ancillary are unavailable for SMPTE ST 2022-6 streams.

Logging - Configuration

The **Logging Configuration** page sets the destination logging server, if required.

Figure 4 - 19: Logging Configuration Page

Parameter	Description
Logging	Set the connection type to the log server. Named LogServer: Specify the specific name of the log server to use for logging. Any LogServer: Logging is sent to any LogServer that is discovered on the network. Logging Disabled: No logging is generated.
Logging Interface	Set the network interface that has network connectivity to the log server. 1G: The Gb management Ethernet network. Ethernet 1: The Ethernet network connected to Media 1. Ethernet 2: The Ethernet network connected to Media 2. See Electrical Connections, Reset Pushbutton, and Status Indicators , on page 29 for the location of the card's Ethernet ports.
Log Server Name	When Logging is set to Named LogServer , this sets the name of the log server to use for logging.
Current Log Server	Shows the name of the current log server being used for logging.
Current Log Server Address	The current log server's Rollcall address.

Logging - System

Information on several parameters can be made available to a logging device connected to the RollCall network. Logging must be configured and enabled; see [Logging - Configuration](#), on page 79.

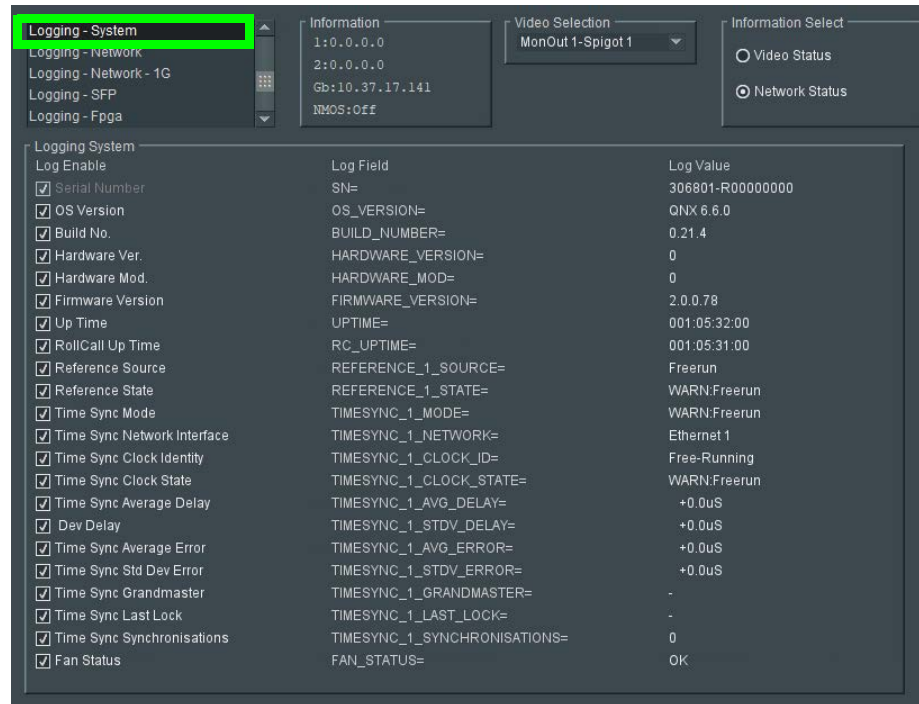

Fig. 4-20: Logging - System Page

The logging page comprises three columns:

Logging Page Column	Description
Log Enable	Select the check boxes that correspond to the parameters for which log information should be collected.
Log Field	Displays the name of the logging field.
Log Value	Displays the current log value.

Enable check boxes to activate log fields as required.

Log Field Parameter	Description
SN=	Logs the card serial number, which consists of an S followed by eight digits. Note: this cannot be deselected.
OS_VERSION=	Logs the operating system name and version.
BUILD_NUMBER=	Logs the build number.
HARDWARE_VERSION=	Logs the hardware version number.

Log Field Parameter	Description
HARDWARE_MOD=	Logs the hardware modification number.
FIRMWARE_VERSION=	Logs the FPGA version number.
UPTIME=	Logs the time since the last restart in the format <i>ddd:hh:mm:ss</i> .
RC_UPTIME=	Logs time RollCall has been up in the format <i>ddd:hh:mm:ss</i> .
REFERENCE_N_SOURCE=	Logs the time reference source.
REFERENCE_N_STATE=	Logs the time reference value. Valid values are: <ul style="list-style-type: none"> • OK:Locked • OK:Input • WARN:Freerun • WARN:CrossLock
TIMESYNC_N_MODE=	Logs the time sync mode value. Valid values are: <ul style="list-style-type: none"> • Free running: Card is using its own clock with no reference to any other source. • PTP Multicast: Card is synchronizing to a PTP grandmaster clock using multicast network messages. • PTP Unicast: As PTP Multicast but using the delay request. Reply messages are unicast to minimize network traffic. • NTP: Card clock is synchronized to an NTP clock. Generally less precise than PTP.
TIMESYNC_N_NETWORK=	Logs the network port currently being used for synchronization for IPVU cards, dependent on the choice of interfaces made on the Time Configuration page. If PTP and multiple interfaces are enabled, the PTP synchronization will switch ports if it doesn't see regular sync messages on the port.
TIMESYNC_N_CLOCK_ID=	Logs the identification number of PTP clock being used for synchronization. This is not necessarily the grandmaster clock identity, as there can be intermediate clocks between the grandmaster and the card, depending on network configuration.
TIMESYNC_N_CLOCK_STATE=	Logs the time sync value. Valid values are: <ul style="list-style-type: none"> • Free running: Card is not being synchronized. • No Lock: PTP being used but clocks haven't synchronized within +/- 1mS. • Locked: PTP being used and clocks are within the accepted range. • NTP: Card using NTP to synchronize.

Log Field Parameter	Description
TIMESYNC_N_AVG_DELAY=	Logs the current network delay time between the card and the clock sending the synchronization messages. This should be relatively constant and is dependent on network configuration.
TIMESYNC_N_STDV_DELAY=	Logs the current standard deviation in the network delay time between the card and the clock sending the synchronization messages. Should be a low number as the network delay is expected to be constant.
TIMESYNC_N_AVG_ERROR=	Logs the current difference between the cards time and the grandmaster time. Should be close to zero once card has synchronized.
TIMESYNC_N_STDV_ERROR=	Logs the standard deviation in the average error.
TIMESYNC_N_GRANDMASTER=	Logs the identity of network clock acting as PTP grandmaster. This is the source of the PTP synchronization messages used by all PTP slave clocks on the network. If there are multiple grandmasters, they should negotiate between themselves to identify the most accurate and then silence the others.
TIMESYNC_N_LAST_LOCK=	Logs the time when the card last changed from not locked to locked. Ideally this will be a few seconds after the card has powered up. This allows you to confirm which clock the card has synchronized to.
TIMESYNC_N_SYNCHRONISATIONS=	Logs the number of times the card has synchronized since it was powered up. Ideally this will be a low number, as cards are expected to synchronize and stay synchronized. Large numbers indicate possible problems with the network or grandmaster clock.
FAN_STATUS	<p>Logs the card's cooling fan health.</p> <ul style="list-style-type: none"> • OK: Fan is operating normally. • FAIL: Card's fan has failed. The fan must be replaced immediately. <p>If this alarm has been raised, the fan on the IPVU card may have to be replaced. Contact Grass Valley Support. See Grass Valley Technical Support, on page 116.</p>

Where N is the input or Ethernet port number. To identify Media 1 / 2, see [Electrical Connections, Reset Pushbutton, and Status Indicators](#), on page 29.

Logging - Network

Information on several parameters can be made available to a logging device connected to the RollCall network. Logging must be configured and enabled; see [Logging - Configuration](#), on page 79.

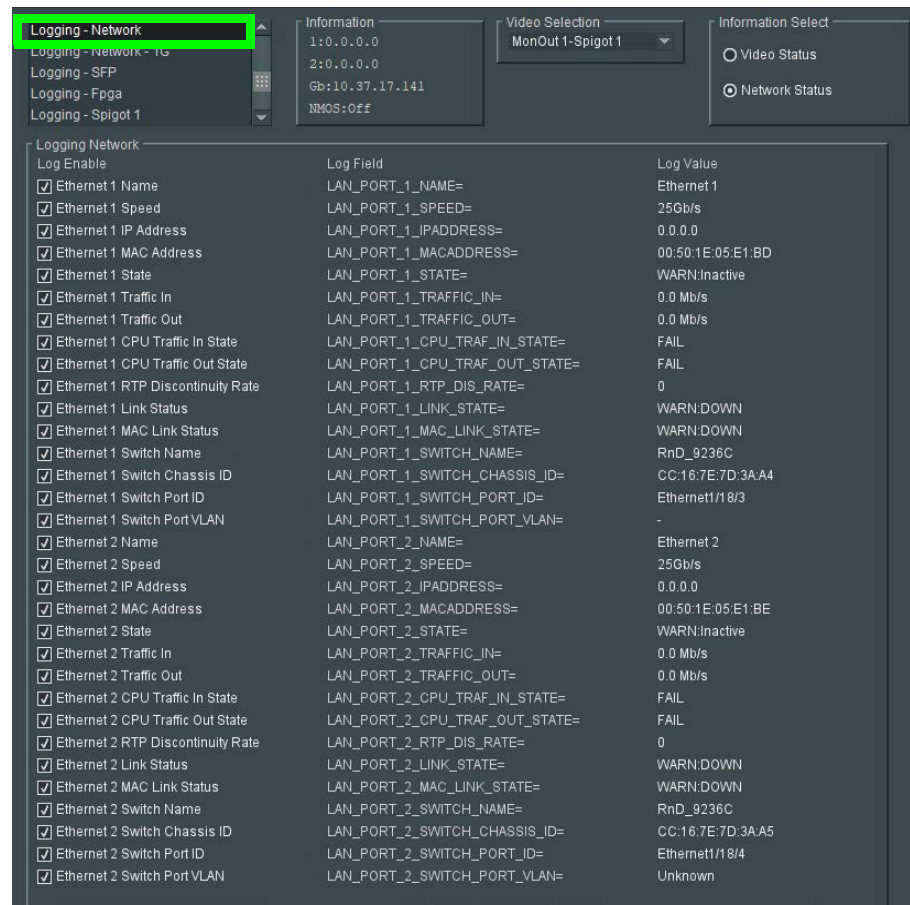

Fig. 4-21: Logging - Network Page

Ethernet 1 represents the IPVU's **MEDIA 1** connection and **Ethernet 2** represents the IPVU's **MEDIA 2** connection. See [Electrical Connections, Reset Pushbutton, and Status Indicators](#), on page 29.

The logging page comprises three columns:

Logging Page Column	Description
Log Enable	Select the check boxes that correspond to the parameters for which log information should be collected.
Log Field	Displays the name of the logging field.
Log Value	Displays the current log value.

Enable check boxes to activate log fields as required.

Parameter	Description
LAN_PORT_N_NAME=	Logs the Ethernet port name.
LAN_PORT_N_SPEED=	Logs the Ethernet connection speed. Valid values are: <ul style="list-style-type: none"> • 10 Mbit/s Full Duplex • 10 Mbit/s Half Duplex • 100 Mbit/s Full Duplex • 100 Mbit/s Half Duplex • 1 Gbit/s Full Duplex • 25 Gbit/s • No Link
LAN_PORT_N_IPADDRESS=	Logs the Ethernet port IP address.
LAN_PORT_N_MACADDRESS=	Logs the Ethernet port MAC address.
LAN_PORT_N_STATE=	Logs the Ethernet connection state. Valid values are: <ul style="list-style-type: none"> • Active • WARN:Inactive
LAN_PORT_N_TRAFFIC_IN=	Logs speed of traffic received by the Ethernet port. Values are reported in kbps, Mbps or Gbps, as appropriate.
LAN_PORT_N_TRAFFIC_OUT=	Logs speed of traffic transmitted by the Ethernet port. Values are reported in Kbps, Mbps or Gbps, as appropriate.
LAN_PORT_N_CPU_TRAF_IN_STATE=	Logs whether the flow of data into the CPU is satisfactory. Valid values are: <ul style="list-style-type: none"> • OK • WARN:LOW DATA • FAIL
LAN_PORT_N_CPU_TRAF_OUT_STATE=	Logs whether the flow of data out of the CPU is satisfactory. Valid values are: <ul style="list-style-type: none"> • OK • WARN:LOW DATA • FAIL
LAN_PORT_N_RTP_DIS_RATE=	Logs RTP discontinuity rate for the Ethernet port.
LAN_PORT_N_LINK_STATE=	Logs the Ethernet link state. Valid values are: <ul style="list-style-type: none"> • OK • WARN:DOWN

Parameter	Description
LAN_PORT_N_MAC_LINK_STATE=	Logs state of the card's FPGA Ethernet link. Valid values are: <ul style="list-style-type: none"> • UP • DOWN
LAN_PORT_N_SWITCH_NAME=	Logs name of the network switch that the card is connected to.
LAN_PORT_N_SWITCH_CHASSIS_ID=	Logs name of the network switch's chassis ID that the card is connected to.
LAN_PORT_N_SWITCH_PORT_ID=	Logs Port ID of the network switch the card is connected to.
LAN_PORT_N_SWITCH_PORT_VLAN=	Logs name of the VLAN that the card is connected to.

Where N is the input or Ethernet port number. To identify Media 1 / 2, see [Electrical Connections, Reset Pushbutton, and Status Indicators](#), on page 29.

Logging - Network - 1G

Information on several parameters can be made available to a logging device connected to the RollCall network. Logging must be configured and enabled; see [Logging - Configuration](#), on page 79.

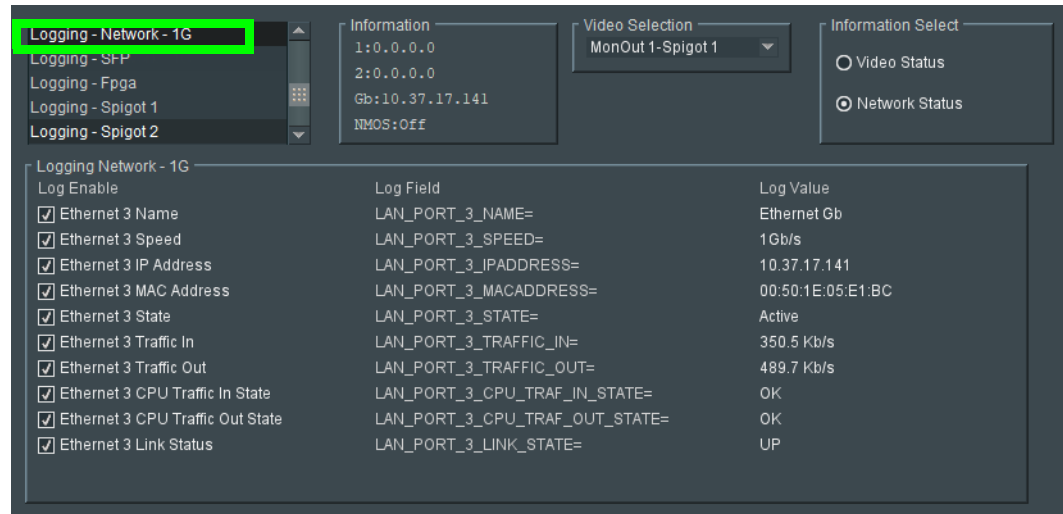

Fig. 4-22: Logging - Network Page

Ethernet 3 represents the IPVU's **MANAGEMENT** connection. See [Electrical Connections, Reset Pushbutton, and Status Indicators](#), on page 29.

The logging page comprises three columns:

Logging Page Column	Description
Log Enable	Select the check boxes that correspond to the parameters for which log information should be collected.
Log Field	Displays the name of the logging field.
Log Value	Displays the current log value.

Enable check boxes to activate log fields as required.

Parameter	Description
LAN_PORT_N_NAME=	Logs the Ethernet port name.
LAN_PORT_N_SPEED=	Logs the Ethernet connection speed. Valid values are: <ul style="list-style-type: none"> • 10 Mbit/s Full Duplex • 10 Mbit/s Half Duplex • 100 Mbit/s Full Duplex • 100 Mbit/s Half Duplex • 1 Gbit/s Full Duplex • No Link
LAN_PORT_N_IPADDRESS=	Logs the Ethernet port IP address.

Parameter	Description
LAN_PORT_N_MACADDRESS=	Logs the Ethernet port MAC address.
LAN_PORT_N_STATE=	Logs the Ethernet connection state. Valid values are: <ul style="list-style-type: none"> • Active • WARN:Inactive
LAN_PORT_N_TRAFFIC_IN=	Logs speed of traffic received by the Ethernet port. Values are reported in kbps, Mbps or Gbps, as appropriate.
LAN_PORT_N_TRAFFIC_OUT=	Logs speed of traffic transmitted by the Ethernet port. Values are reported in Kbps, Mbps or Gbps, as appropriate.
LAN_PORT_N_CPU_TRAF_IN_STATE=	Logs whether the flow of data into the CPU is satisfactory. Valid values are: <ul style="list-style-type: none"> • OK • WARN:LOW DATA • FAIL
LAN_PORT_N_CPU_TRAF_OUT_STATE=	Logs whether the flow of data out of the CPU is satisfactory. Valid values are: <ul style="list-style-type: none"> • OK • WARN:LOW DATA • FAIL
LAN_PORT_N_LINK_STATE=	Logs the Ethernet link state. Valid values are: <ul style="list-style-type: none"> • OK • WARN:DOWN

Where N is the input or Ethernet port number.

Logging - SFP

Information on several parameters can be made available to a logging device connected to the RollCall network. Logging must be configured and enabled; see [Logging - Configuration](#), on page 79.

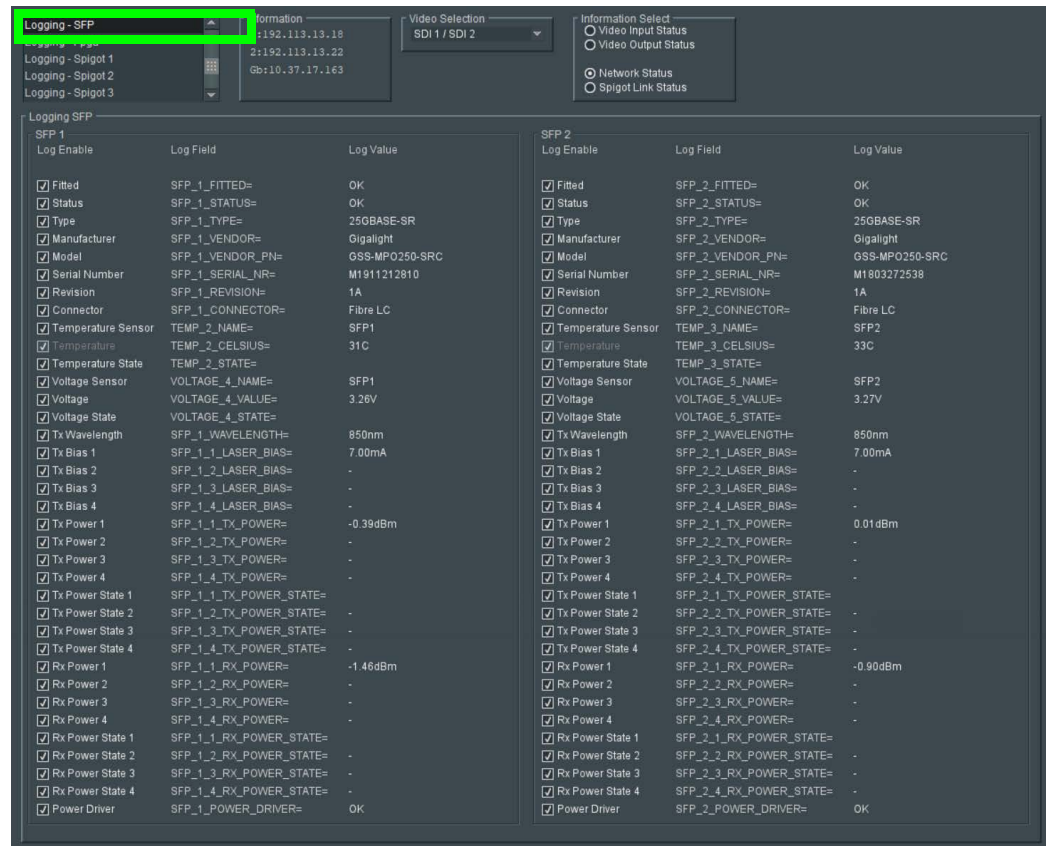

Figure 4 - 23: Logging - SFP Page

The logging page comprises three columns for each SFP:

Logging Page Column	Description
Log Enable	Select the check boxes that correspond to the parameters for which log information should be collected.
Log Field	Displays the name of the logging field.
Log Value	Displays the current log value.

Enable check boxes to activate log fields as required.

Parameter	Description
SFP_N_FITTED=	Logs presence of (Q)SFP. Valid values are: <ul style="list-style-type: none"> • OK • Missing

Parameter	Description
SFP_N_STATUS=	Logs status reported by the (Q)SFP. Valid values are: SFPs <ul style="list-style-type: none"> • OK • WARN:Temp • WARN:VCC • WARN:TX BIAS • WARN:RX BIAS • WARN:Laser • WARN:TEC Curr • FAIL:SFP Not Ready • FAIL:RX LOS - RX Failure • FAIL:TX Fault - TX Failure • FAIL:RX LOL - RX Loss of Lock • FAIL:TX LOL - TX Loss of Lock
SFP_N_TYPE=	Logs (Q)SFP identifier from device.
SFP_N_VENDOR=	Logs (Q)SFP manufacturer from device.
SFP_N_VENDOR_PN=	Logs (Q)SFP model number from device.
SFP_N_SERIAL_NR=	Logs the card serial number, which consists of an S followed by eight digits.
SFP_N_REVISION=	Logs manufacturer revision number.
SFP_N_CONNECTOR=	Logs connector type.
TEMP_N_NAME=	Logs temperature sensor name.
TEMP_N_CELSIUS=	Logs current temperature sensor reading.
TEMP_N_STATE=	Logs temperature sensor state. Valid values are: <ul style="list-style-type: none"> • WARN:Disabled - Temperature sensor disabled. • WARN:Low - Low, but in tolerance. • WARN:High - High, but in tolerance. • OK • FAIL:Low - Low and out of tolerance. • FAIL:High - High and out of tolerance.
VOLTAGE_N_NAME=	Logs voltage sensor name.
VOLTAGE_N_VALUE=	Logs current voltage reading.
VOLTAGE_N_STATE=	Logs temperature sensor state. Valid values are: <ul style="list-style-type: none"> • OK • WARN:Low - Low, but in tolerance. • WARN:High - High, but in tolerance.
SFP_N_WAVELENGTH=	Logs transmit wavelength in nm.
SFP_N_X_LASER_BIAS=	Logs bias level in mA.

Parameter	Description
SFP_N_X_TX_POWER=	Logs transmit power level in dBm.
SFP_N_X_TX_POWER_STATE=	Logs transmit power level. Valid values are: <ul style="list-style-type: none">• OK• WARN:Low - Low, but in tolerance.• WARN:High - High, but in tolerance.• FAIL:Low - Low and out of tolerance.• FAIL:High - High and out of tolerance.
SFP_N_X_RX_POWER=	Logs receive power level in dBm.
SFP_N_X_RX_POWER_STATE=	Logs receive power level. Valid values are: <ul style="list-style-type: none">• OK• WARN:Low - Low, but in tolerance.• WARN:High - High, but in tolerance.• FAIL:Low - Low and out of tolerance.• FAIL:High - High and out of tolerance.

Where N is the input/(Q)SFP number and X is the lane. To identify SFP 1 / 2, see [Electrical Connections, Reset Pushbutton, and Status Indicators](#), on page 29.

Logging - FPGA

Information on several parameters can be made available to a logging device connected to the RollCall network. Logging must be configured and enabled; see [Logging - Configuration](#), on page 79.

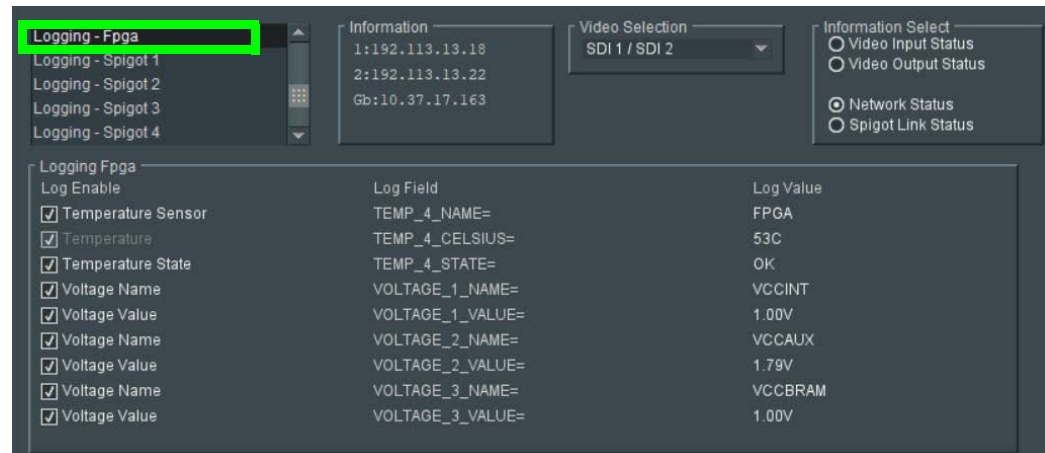

Figure 4 - 24: Logging - FPGA Page

The logging page comprises three columns:

Logging Page Column	Description
Log Enable	Select the check boxes that correspond to the parameters for which log information should be collected.
Log Field	Displays the name of the logging field.
Log Value	Displays the current log value.

Enable check boxes to activate log fields as required.

Parameter	Description
TEMP_N_NAME=	Reports temperature sensor name.
TEMP_N_CELSIUS=	Reports current temperature sensor reading.
TEMP_N_STATE=	FPGA temperature: OK or FAIL .
VOLTAGE_N_NAME=	Voltage sensor name.
VOLTAGE_N_VALUE=	Reports current voltage reading.

Where N is the input number.

Logging - Spigot 1 to 8

The **Logging - Spigot** pages are used to select the fields to be enabled for each available spigot. To identify the application of each spigot, see [Spigot use According to IPVU Output Resolution](#), on page 75. Logging must be configured and enabled; see [Logging - Configuration](#), on page 79.

An additional field is provided for you to optionally specify a name for the input/output spigot name.

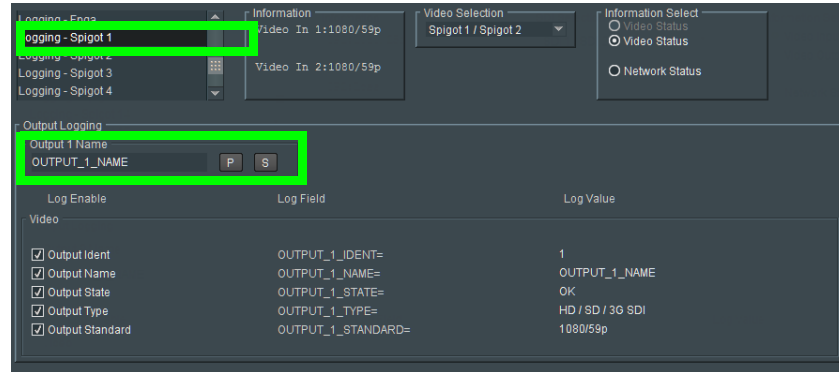

Figure 4 - 25: Output Spigot Logging Page

The logging page comprises three columns:

Logging Page Column	Description
Log Enable	Select the check boxes that correspond to the parameters for which log information should be collected.
Log Field	Displays the name of the logging field.
Log Value	Displays the current log value.

Enable check boxes to activate log fields as required.

Parameter	Description
OUTPUT_N_IDENT=	Name of the output as shown on the rear panel.
OUTPUT_N_NAME=	Name of the output you have defined.
OUTPUT_N_STATE=	Valid values are: <ul style="list-style-type: none"> • OK: output signal good. • FAIL: output signal not detected. • WARN:Freeze • WARN:Pattern • WARN:Black

Parameter	Description
OUTPUT_N_TYPE=	Valid values are: <ul style="list-style-type: none"> • SD SDI • HD SDI • HD/SD/3G SDI
OUTPUT_N_STANDARD	2160/50p, 2160/59p, 1080/50p, 1080/59p, 1080/50i, 1080/59i, 720/50p, 720/59p This value comes from the Spigot > Receiver > Video Std parameter setting. See Spigot 1 to 8 , on page 75.
OUTPUT_N_MAKE_BREAK	Logs how changes to an output's destination will be made. <ul style="list-style-type: none"> • MBB: Make before Break causes the new destination to buffer data before connection to the previous destination is broken; this results in a smoother transition, but requires more bandwidth. • BBM: Break before Make simply swaps the output's destination without buffering.
OUTPUT_N_LINK_STATUS	Logs the status whether this spigot forms part of a quad-linked UHD stream. That is, is it one of the spigots 1 to 4 or 5 to 8 that are linked together to form a UHD flow? OK: Linked : This spigot one part of a quad stream UHD flow. This indicates that the Enable UHD parameter has been set in Monitor Out 1 /2, Video of the IPVU page. See IPVU , on page 56. OK: Not Linked : This spigot is not linked to any other stream. This indicates that the Enable UHD parameter has been deselected in Monitor Out 1 /2, Video of the IPVU page. FAIL: No Input : This spigot has no input.

Where N is the input/output number.

Logging - NMOS

The **Logging - NMOS** pages are used to select the fields to be logged for the card's NMOS connection to the registry. Information on several parameters can be made available to a logging device connected to the RollCall network. Logging must be configured and enabled; see [Logging - Configuration](#), on page 79.



Fig. 4-26: Logging - NMOS Page

The logging page comprises three columns:

Logging Page Column	Description
Log Enable	Select the check boxes that correspond to the parameters for which log information should be collected.
Log Field	Displays the name of the logging field.
Log Value	Displays the current log value.

Parameter	Description
NMOS_STATUS=	The current IPVU's NMOS registry connection status. When the NMOS node registers successfully to NMOS registry service, the status shows a message indicating that it has registered to the IP address, registry port number, and query port number of that NMOS registry service. For example, the message Registered to 10.37.19.115:4041 Query:4041 indicates a successful registration. Whereas, when it fails to register then the status will simply show the message Not registered .
NMOS_REGISTRATION=	The current IPVU's NMOS registry connection mode: Auto: automatic discovery of the NMOS registry using DNS Service Discovery (DNS-SD), as described in AMWA IS-04 NMOS Discovery and Registration Specification v1.2. Static: manually specified NMOS registry values for address, registration port and query port.
NMOS_REGISTRY_IPADDRESS=	The current NMOS registry's IP Address being used to connect to the NMOS registry.
NMOS_QUERY_PORT=	The current port number being used to connect to the NMOS registry for making queries.
NMOS_REGISTRATION_PORT=	The current port number being used to connect to the NMOS registry for making device registrations.

Logging - Card Diagnostics

Information on several parameters can be made available to a logging device connected to the RollCall network. Logging must be configured and enabled; see [Logging - Configuration](#), on page 79.

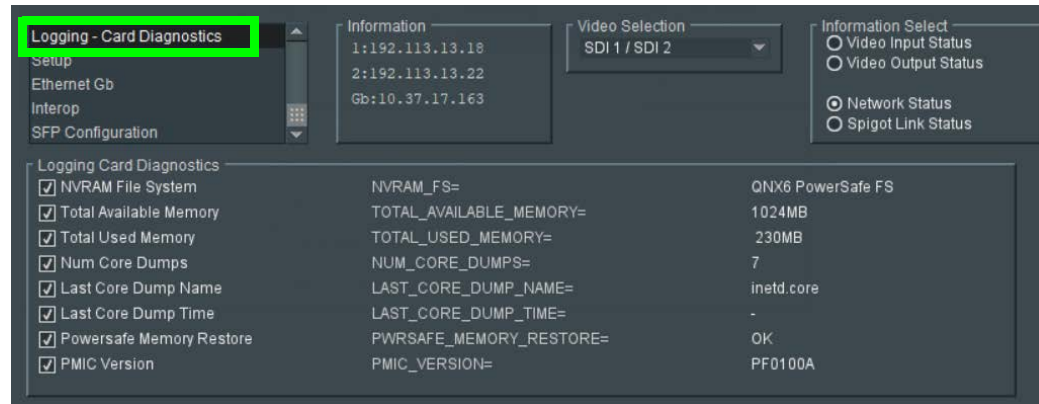

Figure 4 - 27: Logging - Card Diagnostics Page

The logging page comprises three columns:

Logging Page Column	Description
Log Enable	Select the check boxes that correspond to the parameters for which log information should be collected.
Log Field	Displays the name of the logging field.
Log Value	Displays the current log value.

Enable check boxes to activate log fields as required.

Parameter	Description
NVRAM_FS=	Logs whether the installed file system is QNX6 PowerSafe or FAT32.
TOTAL_AVAILABLE_MEMORY=	Logs total amount of CPU memory available to the card, in bytes.
TOTAL_USED_MEMORY=	Logs amount of CPU memory used by the card, in bytes.
NUM_CORE_DUMPS=	Logs number of times a core dump has been performed as a result of an application crash.
LAST_CORE_DUMP_NAME=	Logs name of last application to crash.
LAST_CORE_DUMP_TIME=	Logs time of last core dump performed as a result of an application crash.

Parameter	Description
PWRSafe_MEMORY_RESTORE=	Logs where system memory was restored from. Valid values are: <ul style="list-style-type: none">• FAT32 - restored from FAT32.• OK - restored from QNX6 PowerSafe.• FAIL - memory restoration failed.
PMIC_VERSION=	Logs name of the on-board power management chip.

Setup

The **Setup** page displays basic information about the IPVU, such as the serial number and software version. Use the functions on the page to restart the IPVU or to return all settings to their factory or default settings.

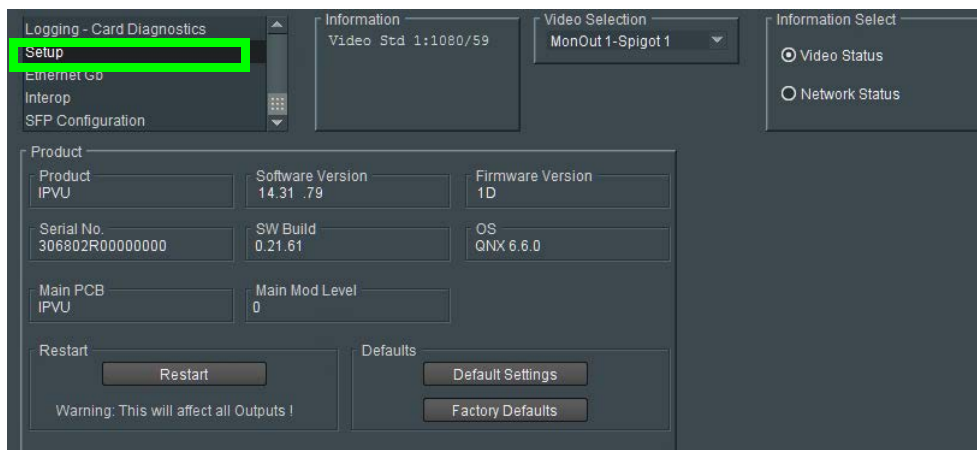

Fig. 4-28: Setup Page

The **Setup** pane displays technical information on the IPVU. You may be asked for these details by Grass Valley support if you need technical assistance. See [Grass Valley Technical Support](#), on page 116.

Item	Description
Product	The build name of the IPVU module.
Software Version	Currently installed software version number.
Firmware Version	Currently installed FPGA firmware version number.
Serial No	IPVU's serial number.
SW Build	Factory software build number. This number identifies all parameters of the IPVU.
OS	Operating system version number.
Main PCB	Printed Circuit Board issue number.
Main Mod Level	Main PCB modification level.

Restart

Power-cycles the IPVU. This will produce disturbances on the output picture.

Note: Restarting the IPVU will affect all **MONITOR OUT** outputs.

Defaults

Provides options to reset the IPVU to its defaults.

Parameter	Description
Default settings	All controls are reset to their default values, except for network configuration and IP addresses.
Factory defaults	All controls are reset to their default values, including network configuration and IP addresses.

Ethernet Gb

The **Ethernet Gb** page shows details and status of the IPVU's **MANAGEMENT** Ethernet connector (see [Electrical Connections](#), [Reset Pushbutton](#), and [Status Indicators](#), on page 29). The IPVU defaults to use of DHCP, but this can be overridden and a static IP address specified if required. See also [Factory Default IP Address and Network Port Usage](#), on page 53.

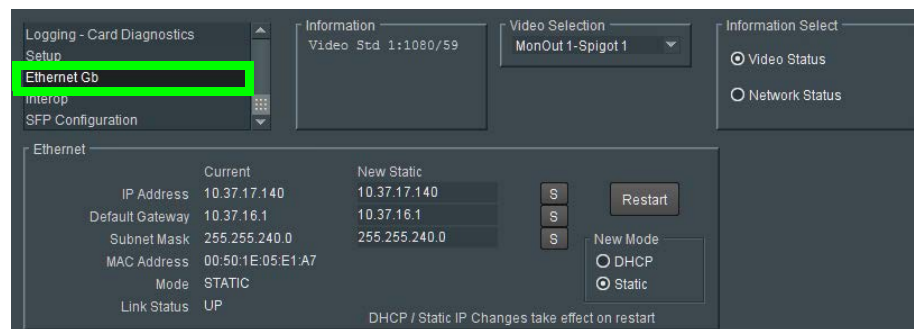

Fig. 4-29: Ethernet Gb Page

The Ethernet Pane

The **Ethernet** pane displays details of the currently selected network interface, and allows a static IP address to be defined. Enter information as required, then click **S** to save. New settings are applied when **Restart** is clicked.

Interop

The Interop page allows certain parameters to be changed in order to improve interoperability with third-party equipment.

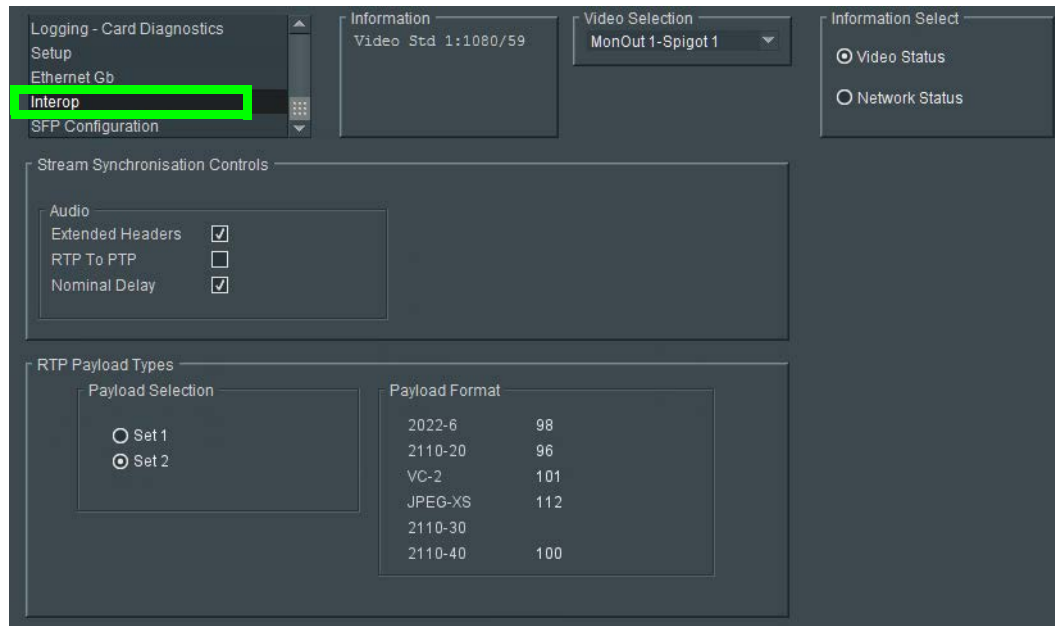

Fig. 4-30: Interop Page

Parameter	Description
Stream Synchronization Controls	<p>Audio:</p> <ul style="list-style-type: none"> Extended Headers - Enable to use extended headers in the RTP audio stream. RTP to PTP - Enable to synchronize RTP to PTP. Nominal Delay - Enable to set nominal delay at the spigot.
RTP Payload Types	<p>Payload Selection:</p> <ul style="list-style-type: none"> Set 1/Set 2 - Select the appropriate set of standards to be used. The set contents are displayed on the Payload Format pane.

SFP Configuration

The **SFP Configuration** page allows various SFP parameters to be adjusted, if required.

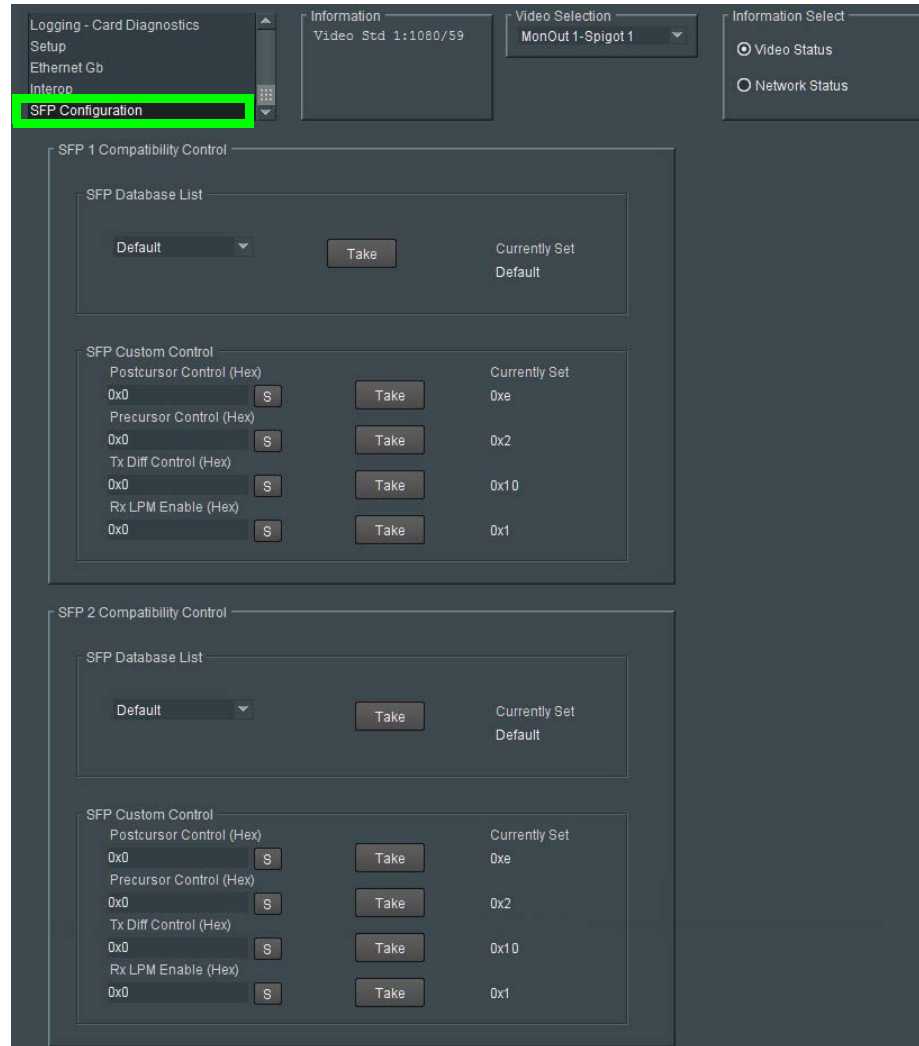

Fig. 4-31: SFP Configuration Page

The majority of SFPs will operate correctly with IPVU without any need for adjustment. Some, however, may need to have IPVU parameters set a little differently.

If difficulties are encountered with an SFP not working as expected, follow these instructions:

- 1 Select the appropriate SFP type from the **SFP Database List**, and click **Take**. Verify whether the SFP is now working correctly; if so, no further action is required.
- 2 If the SFP is still not working properly, select **Custom** from the **SFP Database List**. This allows all the parameters shown to be adjusted as required. Make changes and click **Take** to apply them.
- 3 When a working configuration is found, the parameter values can be saved by clicking **S** beside each field.

5 Maintenance & Troubleshooting

This chapter shows you the various maintenance operations and corrective actions that maybe required to be performed during system commissioning and over the IPVU's lifetime.

Maintenance

Power Cycling an IPVU

When power cycling the IPVU, disconnect the power from the IPVU for at least 5 seconds before reconnecting power again.

Saving and Restoring an IPVU's Configuration

The IPVU's configuration can be saved to your local disk, which is useful in the case you need to return to a previous state. Saving an IPVU's configuration is also used as a preventive measure before a firmware upgrade, so that you can downgrade if necessary and quickly restore the configuration.

Save and restore are found by right-clicking the unit name in the Network Browser.

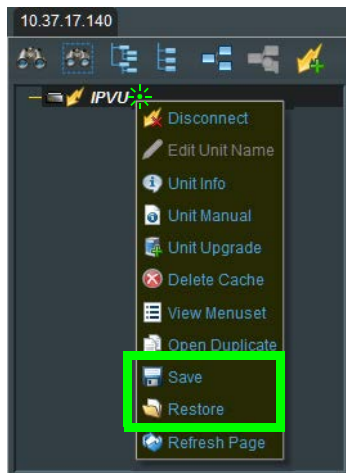

Fig. 5-1: IPVU Menu

For more information about how to use save and restore, see the *RollCall Control Panel User Manual*, available for download from the Grass Valley website. See [Related Documentation](#), on page 19.

Upgrading the IPVU's Firmware

The following is required to proceed:

- A Microsoft Windows PC that:
 - has Internet connectivity.
 - has network connectivity with the IPVU.
 - has RollCall software installed.
- IPVU firmware files.

A firmware upgrade package is supplied by Grass Valley Support and comprises a set of data and installer files. The package is associated with an IPVU software version number, for example, 14.35.80

A firmware upgrade is done in following stages in RollCall:

- **Stage 1:** To [add/import the upgrade package to RollCall Control Panel](#), on page 102.
- **Stage 2:** To [install the upgrade on the IPVU](#), on page 103.
- **Stage 3:** To [delete RollCall's cache for the IPVU](#), on page 105.

To add/import the upgrade package to RollCall Control Panel

- 1 Save the supplied upgrade package(s) to a network location that can be accessed by the Control Panel. Upgrade packages are supplied in a compressed file format (.zip) and they should not be extracted.
- 2 Click **Import New Upgrades** button in the main toolbar

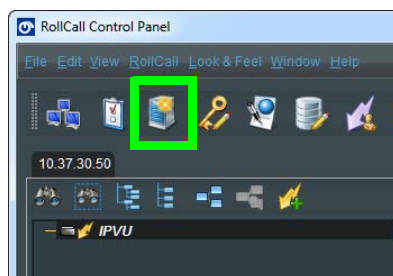

Fig. 5-2: Import new Upgrades

The RollCall Upgrade Packages dialog displays. The left-hand panel displays all currently available upgrades, grouped by unit type.

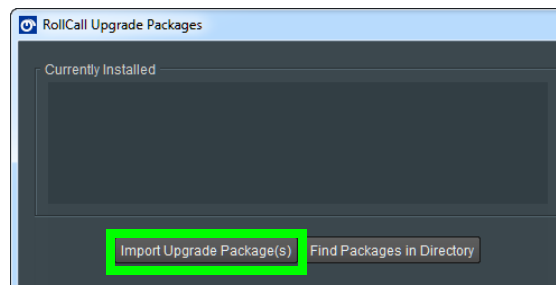

Fig. 5-3: Upgrade Packages

3 Click the **Import Upgrade Package** button.

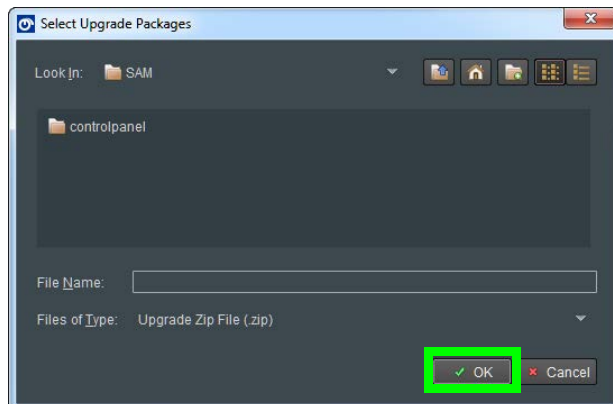

Fig. 5-4: Select Upgrade Package

- 4 Browse to the folder containing the upgrade package.
- 5 Select the upgrade package and click OK.

When the package has been imported, it is added to the list of available upgrades, and units may be upgraded accordingly. See [To install the upgrade on the IPVU](#), on page 103.

To install the upgrade on the IPVU

A unit can only be upgraded if an appropriate upgrade package is available. See [To add/import the upgrade package to RollCall Control Panel](#), on page 102.

- 1 Right-click on the unit name in the Network Browser.
The unit menu displays.

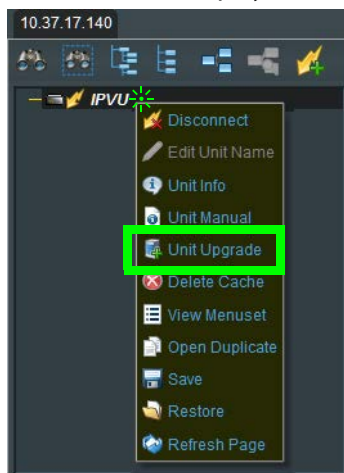

Fig. 5-5: IPVU Menu

- 2 Click on **Unit Upgrade** from the unit menu.
The **Unit Upgrade** dialog displays.

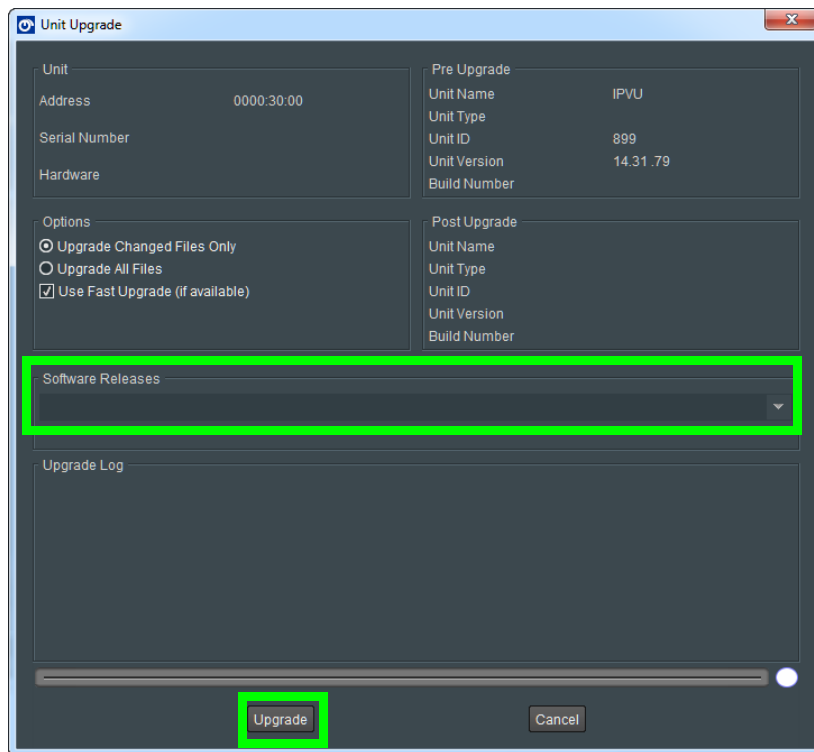

Fig. 5-6: Unit Upgrade Dialog

The following parameters and options are available:

- **Unit** - This panel displays the unit address, serial number, and hardware version (if available).
- **Pre Upgrade** - This panel displays the unit name, unit type, unit ID, unit version and loader version of the unit before the upgrade.
- **Options** - Choose to either upgrade only the files that have changed or to upgrade all files. It is recommended that the **Upgrade Changed Files Only** setting is used to ensure a fast upgrade. However, some units may ignore this setting, and always upgrade all files.
- **Post Upgrade** - After completion of the upgrade, this panel displays the new unit name, unit type, unit ID, unit version and loader version.
- **Software Releases** - This drop-down list shows all of the software releases available for the unit type. Note that before any releases can be shown, software releases must be imported using the Import new Upgrades function available from the

main toolbar. See [To add/import the upgrade package to RollCall Control Panel](#), on page 102.

- **Release Notes** - If release notes are available, clicking this button displays them. If release notes are not available, this button is not displayed.
- **Upgrade Log** - This displays the progress of the upgrade.
- **Cancel** - This closes the Unit Upgrade dialog. If an upgrade is in progress, confirmation of this action is requested.
- **Upgrade** - see below.
- **Import upgrade from unit** - This creates a software release from the version currently on the unit. Note that this option is only displayed if the unit's version is not already in the list of software releases.

3 Select a software version from the **Software Release** dropdown.

4 Click **Upgrade**.

This starts the upgrade process. Prior to the upgrade process beginning, a check is made to see whether the unit's current version is available in the list of software releases. If not, a dialog displays prompting to save the unit's current software release before upgrading.

Note: The control panel cannot be used while performing an upgrade.

At the end of the upgrade, if the unit does not come back online, a dialog displays.

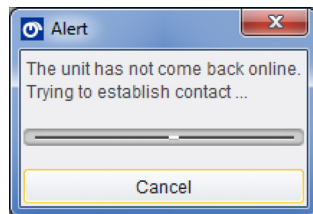

Further attempts are made to establish contact with the unit until it either, comes back online, or the Cancel button is pressed. Cancelling this operation has no effect on the success or otherwise, of the upgrade operation.

To delete RollCall's cache for the IPVU

If the upgrade changes any RollCall menu, then these IPVU menus in RollCall may be empty or configuration information is missing or incoherent. Always delete RollCall's cache for the IPVU after an upgrade.

- 1 In RollCall, right-click IPVU and select Delete Cache.

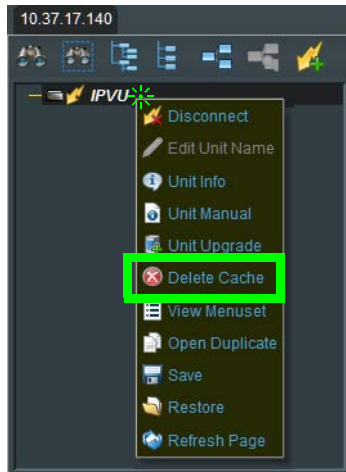

Fig. 5-7: IPVU Menu

- 2 Close and restart RollCall.

Troubleshooting

Following a methodical process of elimination, try the following steps.

- 1 Are you using the latest IPVU firmware? To upgrade an IPVU's firmware, see [Firmware Upgrade](#), on page 53.
- 2 The Status Indicators on the IPVU show if it is powered and these indicators provide troubleshooting information. See [Electrical Connections, Reset Pushbutton, and Status Indicators](#), on page 29.
- 3 The IPVU has certain requirements to operate correctly. See [Unsupported Applications](#), on page 18.
- 4 Try using another monitor cable. Make sure the cable is less than 6 feet (1.8m) long.
- 5 Make sure the fiber connectors are clean, as the problem is often related to dust obstructing the light at the fiber connections. See [Keep Fiber Connections Clean](#), on page 108.
- 6 Use another fiber connection.
- 7 Swap components of the IPVU with known working components, one component at a time in a systematic fashion to further isolate the issue. For example, swap the SFP transceiver cartridges or use a different port on the network switch.

Further troubleshooting.

Problem	Possible solutions...
Screen is not displayed, but status LED is green	<p>Make sure the monitor supports the resolution used by the IPVU. If your monitor supports it, turn the automatic resolution detection on.</p> <p>Make sure the display is turned on.</p> <p>Test the monitor by feeding it a signal from another source.</p>
Status LED is BLINKING even with a fiber present	<p>Make sure you are using the right multimode fiber type. By convention, the cable should be orange.</p> <p>Make sure the fiber connector is properly seated in the SFP cartridge.</p> <p>Make sure the media network switch is a powered-up.</p> <p>Make sure the total loss in the optical path is not greater than 2.5 dB, due to any combination of factors mentioned here. Measure the loss if necessary.</p> <p>Check the fiber for any damage. The fiber cannot have small circumference loops.</p> <p>Check the fiber connectors for dirt and debris. See Keep Fiber Connections Clean, on page 108.</p> <p>Make sure your fiber length is within the range of the media network switch and of the SFP cartridge's specification.</p> <p><i>Note: depending on fiber type, and if splices are done on your fiber, the actual maximum usable length will be reduced.</i></p>
Status LED is ORANGE	Make sure the source is active.
Status LED is RED	Disconnect the HDMI and power cable (see Power Cycling an IPVU , on page 101). Then, reconnect the power cable, make sure the LED is on and connect the HDMI cable.
Status LED is off	Make sure the power cable connection is secure and that it is connected to a live AC power source.
After the IPVU has had its firmware upgraded, the menus for IPVU in RollCall are empty or configuration information is missing or incoherent	See To delete RollCall's cache for the IPVU , on page 105.

When contacting Grass Valley Technical Support, they may ask for product information. This is found in the **Setup** pane. See [Setup](#), on page 97.

Testing if Network Redundancy (SMPTE ST 2022-7) is Working

During off hours when the system is not in use, you can verify that network redundancy (SMPTE ST 2022-7) is working.

- 1 Set the **Flow Type** to **none** in the Spigot configuration screen for the primary stream to test the secondary stream and vice versa. Note that the **Flow Type** is set to SMPTE ST

2110 for either the primary stream or the secondary stream to allow traffic to flow on one of the SFP channels at a time. See [Spigot Page Overview](#), on page 76.

- 2 Click **Save** to start the test.
- 3 Perform this test on both the card's input and output spigots.
- 4 To restore normal operation, set the **Flow Type** to SMPTE ST 2110 for the primary stream and the secondary stream for all input and output spigots.

Keep Fiber Connections Clean

The physical interface between the optical fiber and the fiber port of the SFP cartridge is the critical point in the system. The fiber and the optical port must be accurately aligned – that's the job of the connector plugs and sockets – and be in intimate contact with no obstructions - that's your job. The small size of the fiber, and the even smaller size of the fiber core, means that even common dust particles can seriously impair the transfer of light from one fiber to another.

There are a variety of cleaning solutions available to help the fiber user maintain good fiber network performance. For best results, it should be possible for you to perform a visual inspection of the fiber ends to verify cleanliness.

Grass Valley strongly urges all users to select a cleaning method that meets their needs, and to use it rigorously and consistently.

A few tips:

- When an optical fiber is disconnected from the SFP module's optical port, always:
 - Insert a dust plug into the empty SFP module's optical port.
 - Install caps on the open end of the fiber optic cable.

This keeps airborne particles from settling on the fiber end or in the SFP module's optical port.

- Keep your dust plugs and caps clean – always store them in a sealed container.
- Always follow the instructions carefully when cleaning – abrasions on the fiber ends can degrade system performance significantly.
- A visual inspection will ensure that particles and liquid residue have been removed.
- If it's still dirty, clean it again.

Note: The SFP module's optical ports cannot be cleaned.

If dust enters the SFP module's optical port to the point where performance degrades, the corrective action is to replace the damaged SFP module with a new one.

6 Specifications

Status LEDs

See [Electrical Connections, Reset Pushbutton, and Status Indicators](#), on page 29.

Inputs & Outputs

MEDIA 1 & 2 Ports

Physical	2 × SFP28 Ethernet cartridge slots
Supported SFP28 cartridges	See Supported MEDIA Port SFP28 Cartridges , on page 20
Speed	10 or 25 GbE
Ethernet	IEEE 802.3-2008 10 GigE IEEE 802.3cc
Transport Formats	ST 2110-10 ST 2110-20 ST 2110-21 N, NL and W profiles ST 2110-30 Level A and D profiles ST 2022-6; video essence only. Audio and ancillary essences for this flow type are unsupported. ST 2022-7 Class A
NMOS	IPVU supports Networked Media Open Specifications (NMOS) AMWA IS-04 for device discovery and registration and IS-05 for connection management. Furthermore, it supports AMWA BCP-002-01 for the natural grouping of NMOS resources.
PTP	ST 2059
Maximum SFP28 power	1.5 Watts per Ethernet cartridge slot
Type	OM4 Multimode fiber (MMF), Single fiber cable Field supplied

IP Channel Inputs

Channels	2
Video	2160p59.94, 2160p50 2-SI quad flow 2160p59.94, 2160p50 SDQS quad flow ^a 2160p59.94, 2160p50 single raster ^a 1080p59.94, 1080p50 1080i59.94, 1080i50 720p59.94, 720p50
Audio	Single stream per MEDIA output connection Up to 32 channels, only the first 8 are available for use per MEDIA output connection, 125us to 4ms
Processing delay	< 1 frame

a. Available on demand

MONITOR OUT

Physical	2 × Type A
Retainer Screw-Lock Pin	7.975 mm distance from the center of the connector to the center of the screw lock pin
Transport	HDMI 2.0b EIA/CEA-861-E
Resolution	720p / 1080i / 1080p / 2160p Same resolution as the IP channel input
Frame Rate	50 / 59.94 Hz Same rate as the IP channel input
Required HD Cable	Standard or better
Required UHD cable	Premium High Speed or better

MANAGEMENT Port

Physical	RJ-45
Speed	10MB, 100MB, or 1GB
Ethernet	IEEE 802.3.ab

Power

AC Input	100 to 240 VAC
Line frequency	50 / 60 Hz
Nominal	35 VA

Maximum	60 VA
Current	0.6 to 0.25 Amps
Socket	IEC 60320 C14
Power cord connector	IEC 60320 C13
Power cord length	6 foot (1.8M) cable

Status Indicators

See [Status Indicator Interpretation](#), on page 30.

Environmental

Weight	
IPVU	2.0lb (930g)
Dimensions	See IPVU Mechanical Dimensions , on page 22
Cooling	See Mounting Requirements , on page 33
Temperature Range	
Operating	32 to 104°F (0 to 40°C)
Storage	-40 to 185°F (-40 to 85°C)
User safety	When an open fiber condition is detected, the lasers are turned off.

Compliance

FCC Part 15 Class B	Susceptibility, Radiated and Conducted
CE	Susceptibility, Radiated and Conducted
Optical Fiber Communication System	Class 1 Eye Safety per IEC 60825-1
IEC 60825-1:2014-05 Ed. 3.0	
FDA	CDRH
Safety approvals	CB Report (IEC60950-1) UL (UL/cUL60950-1, approved as limited power source (LPS)) TUV (EN60950-1)

Installing the SFP Ethernet Module

Introduction

Installing and removing the SFP output interface cartridge requires special care. This annex describes the process.

Rear panels incorporate one or two SFP interface(s). The interface consists of two parts:

- A socket on the rear panel into which an SFP interface module is plugged
- An SFP (Small Form-factor Pluggable) module that performs output medium translation to which connections are made for optical fibers, coaxial copper, and so on.

CAUTION

- SFP fiber Transmitter modules contain a class 1 laser, which emits invisible radiation whenever the module is powered up. Because the SFP is hot-swappable, the module may be powered up as soon as it is installed.
- DO NOT LOOK INTO AN OPERATING SFP FIBER MODULE'S CONNECTORS, AS EYE DAMAGE MAY RESULT.
- The SFP module is sensitive to electrostatic discharge (ESD). It is recommended that you use an ESD-preventive wrist strap grounded to the GV Node chassis while handling the SFP module.
- SFP modules are subject to wear, and their useful lifetime is reduced each time they are inserted or removed. Do not remove them more often than is absolutely necessary.
- Never remove or install an SFP fiber module with the fiber optic cables connected. Damage to the cables could result.
- The presence of dust and debris can seriously degrade the performance of an optical interface. It is recommended that you insert a dust plug into the SFP fiber module whenever a fiber optic cable is not connected.

Installing an SFP module

- 1 Make sure that the bale clasp lever is in the closed position.

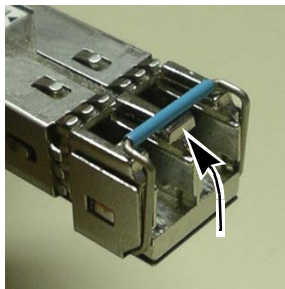

- 2 Position the SFP module so that the recessed slot is lined up with the tab side of the socket.

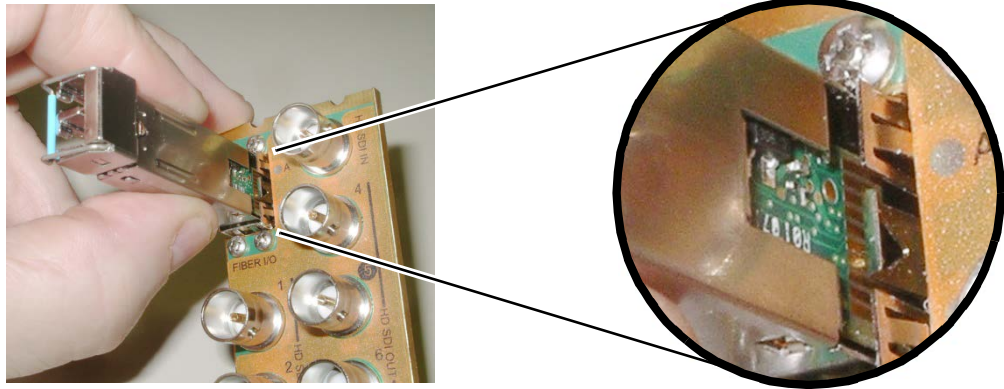

- 3 Slide the module straight into the socket, and push gently until it clicks into position.

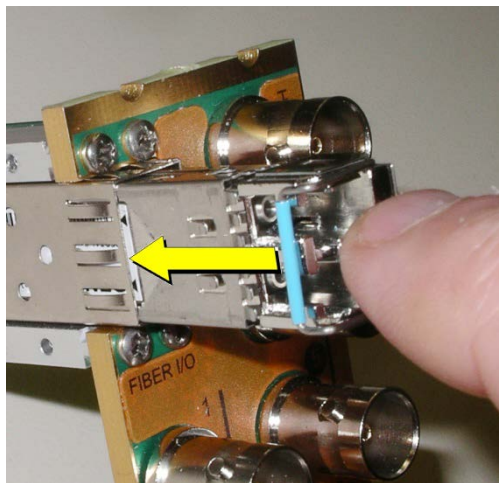

Connecting the fiber optic cables

- 1 Remove the dust plug from the SFP module if present
- 2 Verify that the exposed end of the optical fiber in the LC connector is clean
 - Carefully remove any debris if necessary.
- 3 Plug the LC-terminated fiber optic cable into the SFP module

Removing the fiber optic cables

- 1 Grasp the LC fiber optic connector that is plugged into the SFP module, and pull it straight out to disengage the optical fiber from the SFP.
 - Never pull the fiber optic cable itself, as irreversible damage may occur.
- 2 Insert a dust plug into the SFP module.
- 3 Install caps on the open end of the fiber optic cable.

Removing the SFP module

- 1 Move the bale clasp lever to the open position.

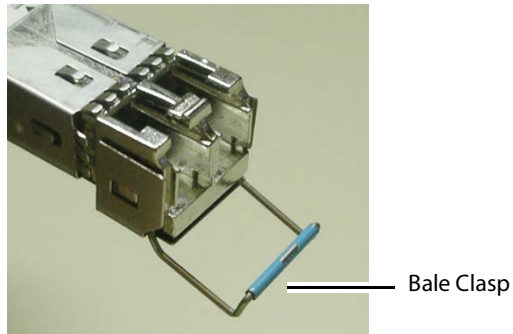

- 2 Grasp the SFP module between your thumb and forefinger, and pull it straight out of the slot.

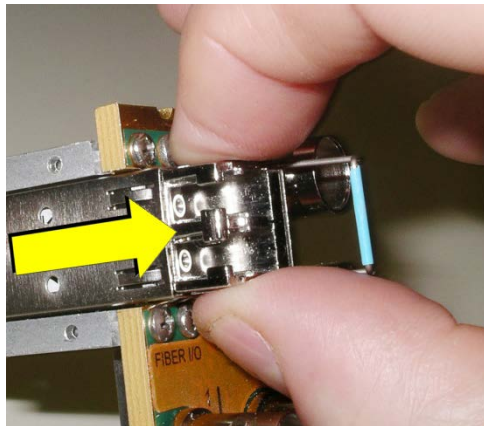

- Do NOT pull on the bale clasp lever to remove the module, as it is easily damaged.
 - You may find that you need to wiggle the module, or perhaps push it into the slot a bit, before it will release and slide out.
- 3 For fiber optic models, insert a dust plug into the SFP module.



Grass Valley Technical Support

For technical assistance, contact our international support center, at 1-800-547-8949 (US and Canada) or +1 530 478 4148.

To obtain a local phone number for the support center nearest you, please consult the Contact Us section of Grass Valley's website (www.grassvalley.com).

An on-line form for e-mail contact is also available from the website.

Corporate Head Office

Grass Valley
3499 Douglas-B.-Floreani
St-Laurent, Quebec H4S 2C6
Canada
Telephone: +1 514 333 1772
Fax: +1 514 333 9828
www.grassvalley.com