

Aurora Edit

FAST-TURN PRODUCTION TOOLS



User Guide
Software Version 7.0



Affiliate with the N.V. KEMA in The Netherlands



CERTIFICATE

Certificate Number: 510040.001

The Quality System of:

Thomson Inc, and its worldwide Grass Valley division affiliates DBA GRASS VALLEY

Headquarters
400 Providence Mine Rd
Nevada City, CA 95959
United States

15655 SW Greystone Ct.
Beaverton, OR 97006
United States

10 Presidential Way
Suite 300
Woburn, MA 01801
United States

Kapittelweg 10
4827 HG Breda
The Netherlands

7140 Baymeadows Way
Ste 101
Jacksonville, FL 32256
United States

2300 So. Decker Lake Blvd.
Salt Lake City, UT 84119
United States

Rue du Clos Courtel
CS 31719
35517 Cesson-Sevigné Cedex
France

1 rue de l'Hautil
Z.I. des Boutries BP 150
78702 Conflans-Sainte
Honorine Cedex
France

Technopole Brest-Iroise
Site de la Pointe du Diable
CS 73808
29238 Brest Cedex 3
France

40 Rue de Bray
2 Rue des Landelles
35510 Cesson Sevigné
France

Spinnereistrasse 5
CH-5300 Turgi
Switzerland

Brunnenweg 9
D-64331 Weiterstadt
Germany

Carl-Benz-Strasse 6-8
67105 Schifferstadt
Germany

Including its implementation, meets the requirements of the standard:

ISO 9001:2008

Scope:

The design, manufacture and support of video and audio hardware and software products and related systems.

This Certificate is valid until: June 14, 2012
This Certificate is valid as of: June 14, 2009
Certified for the first time: June 14, 2000

H. Pierre Sallé
President
KEMA-Registered Quality

The method of operation for quality certification is defined in the KEMA General Terms And Conditions For Quality And Environmental Management Systems Certifications. Integral publication of this certificate is allowed.

KEMA-Registered Quality, Inc.
4377 County Line Road
Chalfont, PA 18914
Ph: (215)997-4519
Fax: (215)997-3809

CRT 001 073004

Accredited By:
ANAB

Experience you can trust.



Aurora Edit

FAST-TURN PRODUCTION TOOLS

User Guide
Software Version 7.0

Copyright

Copyright © Grass Valley, Inc. All rights reserved. Printed in the United States of America. Portions of software © 2000 – 2010, Microsoft Corporation. All rights reserved. This document may not be copied in whole or in part, or otherwise reproduced except as specifically permitted under U.S. copyright law, without the prior written consent of Grass Valley, Inc., P.O. Box 59900, Nevada City, California 95959-7900. This product may be covered by one or more U.S. and foreign patents.

SkinCrafter Component Copyright 2002-2005 DMSOft Technologies

Disclaimer

Product options and specifications subject to change without notice. The information in this manual is furnished for informational use only, is subject to change without notice, and should not be construed as a commitment by Grass Valley, Inc. Grass Valley, Inc. assumes no responsibility or liability for any errors or inaccuracies that may appear in this publication.

U.S. Government Restricted Rights Legend

Use, duplication, or disclosure by the United States Government is subject to restrictions as set forth in subparagraph (c)(1)(ii) of the Rights in Technical Data and Computer Software clause at DFARS 252.277-7013 or in subparagraph c(1) and (2) of the Commercial Computer Software Restricted Rights clause at FAR 52.227-19, as applicable. Manufacturer is Grass Valley, Inc., P.O. Box 59900, Nevada City, California 95959-7900 U.S.A.

Trademarks and Logos

Grass Valley, K2, Aurora, Summit, Dyno, Solo, Infinity, Turbo, Profile, Profile XP, NetCentral, NewsBrowse, NewsEdit, NewsQ, NewsShare, NewsQ Pro, and Media Manager are either registered trademarks or trademarks of Grass Valley, Inc. in the United States and/or other countries. Grass Valley, Inc. products are covered by U.S. and foreign patents, issued and pending. Additional information regarding Grass Valley, Inc. trademarks and other proprietary rights may be found at www.grassvalley.com. Other trademarks and logos used in this document are either registered trademarks or trademarks of the manufacturers or vendors of the associated products, such as Microsoft® Windows® operating system, Windows Media® player, Internet Explorer® internet browser, and SQL Server™. QuickTime and the QuickTime logo are trademarks or registered trademarks of Apple Computer, Inc., used under license therefrom.



Revision Status

Rev Date	Description
June 30, 2006	Release 071-8500-00 for Software Version 6.0
October 26, 2006	Release 071-8500-01 for Software Version 6.0a
May 3, 2007	Release 071-8500-02 for Software Version 6.1
September 7, 2007	Release 071-8500-03 for Software Version 6.3
November 21, 2008	Release 071-8500-04 for Software Version 6.5A
April 21, 2010	Release 071-8500-05 for Software Version 7.0

Contents

Grass Valley Product Support.....	13
Chapter 1: Introducing Aurora Edit.....	15
What is Aurora Edit?.....	16
Quick overview of editing with Aurora Edit.....	16
Supported formats.....	16
Tour of the Aurora Edit window.....	18
Main toolbar.....	18
Bin.....	19
Timeline.....	21
Dynamic tool window.....	23
Viewing monitor.....	24
Storyboard.....	24
Audio mixer.....	25
The Assignment List Manager.....	25
Aurora Edit tools.....	26
Timeline Tool	26
Source Tool	27
Trim Tool	28
Cut Point Edit Tool	29
Transition Tool	30
Audio Mixer Tool	30
Audio Effects Tool	31
Video Effects Tool	32
Title Tool	33
Graphic Tools.....	34
The Aurora Edit keyboard.....	35
Tool selection keys.....	35
Transport command keys.....	36
Editing and clip/track selection keys.....	37
Mark point keys.....	38
Track selection keys.....	40
Other Aurora Edit keys.....	41
Command pulldown menu.....	42
Keyboard shortcuts.....	42
Aurora Edit keyboard shortcuts.....	43
Edit setup keyboard shortcuts.....	43
Selecting and moving keyboard shortcuts.....	44
Play speed keyboard shortcuts.....	45
Tracks keyboard shortcuts.....	45
Transports keyboard shortcuts.....	46
Video effects keyboard shortcuts.....	46
MediaFrame keyboard shortcuts.....	47
Chapter 2: Working in the Bin.....	49

About the Bin window.....	50
Creating a new bin.....	50
How to organize your Bins.....	51
Saving the Bin position.....	52
Working in shared or local mode.....	52
Viewing clips in your Bin.....	53
Details view.....	53
Thumbnail view.....	55
Working with clips in the Bin.....	55
Searching for a clip or sequence.....	55
Copying a clip or sequence.....	56
Moving a clip or sequence.....	57
Renaming bins and media files.....	57
Deleting clips and sequences.....	57
Changing master clip properties	57
SmartBins.....	58
Understanding SmartBins	58
Creating a Transfer SmartBin.....	58
Creating a Shared SmartBin	59
Chapter 3: Using MediaFrame to manage media.....	61
Understanding MediaFrame.....	62
Searching for media.....	62
Setting search criteria.....	62
Tips for using search criteria.....	63
Saving a search.....	66
Working with searches.....	66
Using filters to refine a search.....	67
Using Explore to bookmark locations.....	69
Using Collections to categorize clips.....	70
About Collections.....	70
Creating a collection.....	70
Modifying Collections.....	71
Viewing Collection contents.....	71
Adding assets to a collection.....	71
Using metadata to define clips.....	72
About metadata.....	72
Adding general information.....	72
Using keywords to define clips.....	73
Managing custom metadata fields.....	75
Using custom metadata fields.....	76
Printing metadata.....	76
Chapter 4: Acquiring media.....	79
Using clips stored in the Bin.....	80
Using a clip source.....	80
Recording to the Bin.....	80
Using files from removable media	81
Importing files.....	82
Importing clips.....	82

Importing EDL files.....	82
Importing effects.....	83
Importing graphic files.....	83
Importing media	84
Importing a TGA animation sequence	86
Importing a MOV Animation File	87
Batch recording.....	88
About batch recording.....	88
Creating a Batch Capture list.....	89
Rearranging the Batch Capture list.....	90
Changing row colors in the Batch Capture list.....	90
Saving a Batch Capture list.....	91
Loading a Batch Capture list.....	91
Recording clips to the Bin.....	91
Chapter 5: Preparing to edit.....	93
Creating a new sequence.....	94
Changing sequence properties.....	95
Preserving ANC Data.....	96
Selecting and deselecting tracks.....	97
About editing modes.....	97
Naming source tapes.....	98
Routing audio tracks.....	98
Using variable speed record.....	99
Selecting your source.....	100
Using a clip source.....	100
Changing sources.....	100
Using auxiliary input.....	100
Linking to an existing news or sports story.....	101
Story View functions.....	103
Adjusting the read count in Story View.....	105
Using the Assignment List Manager.....	105
Editing and Aurora Payout.....	107
Creating placeholders in the Assignment List.....	107
Viewing by category in the Assignment List.....	109
Changing the clip category in the Assignment List.....	109
Identifying missing clips.....	109
Deleting placeholders in the Assignment List.....	110
Chapter 6: Working in the Timeline.....	111
Understanding Aurora Edit's Agile Timeline.....	112
Mark Points.....	112
About Mark Points.....	112
Marking In and Out Points.....	113
Setting up a split edit.....	113
Controlling a deck from Aurora Edit.....	114
Zooming in on a clip source.....	115
Tips for using the zoom controls.....	116
Changing the Timeline view manually.....	117
Using Auto-Scale to adjust the Timeline view automatically.....	117

Toggling tracks on the fly.....	118
Moving clips.....	118
Moving clips in the Timeline.....	118
Moving audio clips.....	119
Copying clips to the Timeline.....	119
Copying and pasting clips.....	119
Copying a selected area of a sequence.....	120
Using Quick Edit mode.....	120
Creating your clips.....	120
Playing a sequence.....	121
Saving a sequence.....	122
Splitting clips.....	122
Lifting clips.....	123
Lifting clips from the Timeline.....	123
Lifting an area of a sequence.....	123
Deleting clips.....	124
Deleting a clip from your sequence.....	124
Deleting an area from a sequence.....	125
Saving the Timeline track configuration	125
Chapter 7: Trimming clips.....	127
Trimming your clips.....	128
Using handles to add frames to your clips.....	128
Locking the duration of a clip.....	128
Playing Past Out.....	129
Changing cut points between adjacent clips.....	129
About adjusting cut points	129
Changing cut points.....	129
Navigating to cut points.....	130
Using audio scrubbing.....	131
Extending an individual track.....	131
Extending your edits.....	131
Trimming your media clips in the Bin.....	132
Creating SubClips.....	133
Copying a clip to the Timeline.....	133
A quick way to edit.....	133
Chapter 8: Transitions.....	135
Transitions in Aurora Edit.....	136
Understanding transition types.....	136
Dissolves.....	137
Wipes.....	137
Pushes.....	137
Slides.....	138
Creating a transition.....	138
Changing transitions.....	139
Creating wipes.....	140
Adding a border to a wipe.....	140
Changing the border color of a Wipe.....	141
Reversing a Wipe.....	141

Rendering transitions.....	141
Creating transitions for an area of the sequence	142
Deleting transitions.....	142
Audio crossfades.....	143
About audio crossfades.....	143
Applying crossfades to the audio tracks only.....	143
Applying crossfades automatically with transitions.....	143
Chapter 9: Audio.....	145
Adjusting audio levels.....	146
About adjusting audio levels in Aurora Edit.....	146
Viewing audio levels on the Timeline.....	146
Changing audio levels in a clip.....	148
Removing fade control points.....	148
Ganging and adjusting multiple audio tracks.....	149
Monitoring audio tracks.....	149
Soloing an audio track.....	149
Muting an audio track.....	149
Using the Master Audio Sliders to set output level.....	150
Setting Timeline audio settings.....	151
Adjusting audio gain.....	152
Using Audio Automation.....	153
Showing Audio Automation.....	153
Removing Audio Automation.....	153
Adding audio narration	154
Audio effects.....	154
About audio effects.....	154
Equalizing audio in a recorded sequence.....	155
Using a previously applied Audio EQ effect.....	157
Disguising a voice in a clip.....	157
Enhancing audio using OMF files	159
Exporting an Aurora Edit sequence as an OMF file	159
Enhancing audio with Digidesign Pro Tools	160
Enhancing audio with Steinberg Nuendo	161
Enhancing audio with Fairlight and AVTransfer	163
Importing enhanced OMF files back into Aurora Edit	164
Chapter 10: Advanced editing.....	165
Converting clip aspect ratios.....	166
About aspect ratio conversion.....	166
Aspect ratio conversion types.....	167
Manually converting a clip aspect ratio.....	167
Creating an aspect ratio preset.....	168
Inserting filler between clips.....	168
Creating a Fit To Fill.....	169
Adding a freeze frame to your sequence.....	170
Varying the speed of a clip.....	171
Creating split edits.....	171
Using control track.....	172
Using Match Frame.....	172

Match Frame to Bin.....	172
Match Frame to source.....	173
Editing using offline proxy media.....	173
Seaching for Offline Assets.....	174
Moving offline assets to the Timeline.....	175
Restore and synchronize offline assets.....	176
Unlinking restored assets.....	179
Linking video MOS objects to the Timeline.....	180
About Aurora Edit and Final Cut Pro.....	183
Exporting an Aurora Edit sequence as a Final Cut Pro EDL	183
Importing an Aurora Edit sequence on Final Cut Pro	184
Exporting a Final Cut Pro file	184
Converting existing Aurora Edit files to .mov format	185
Opening an Aurora Edit clip on Final Cut Pro	185
Chapter 11: Video effects.....	187
Creating video effects - overview.....	188
Understanding video effects.....	189
Moving the foreground image within the viewer window.....	190
Moving foreground image—dragging image.....	190
Moving foreground image—using the joystick.....	190
Moving foreground image—moving the resize slider.....	190
Moving foreground image—adjusting the dials.....	190
Moving foreground image—using the keyboard.....	191
Adding a video effect to the Timeline.....	191
Other ways to add a video effect to the Timeline.....	192
Changing the duration of a video effect.....	192
Using saved effects in your sequence.....	192
Importing video effects.....	193
Choosing a video effect.....	194
Using video effect options.....	194
Adding effect properties.....	195
Working with keyframes.....	196
Understanding keyframes.....	196
Inserting keyframes.....	197
Modifying keyframes.....	197
Setting a path for your video effect.....	198
Video effect paths.....	199
Viewing video effects within your sequence.....	200
Saving video effects.....	200
Rendering video effects.....	200
Layering video effects.....	201
Exporting video effects.....	201
Effects & what they do.....	202
How video effects work together.....	202
Understanding video effects and keyframes.....	202
Resize video effect.....	204
Key Shape video effect.....	204
Blur & mosaic video effects.....	205
Color Effect.....	207

Proc Amp video effect.....	208
Color correction video effect.....	208
Mirror Vertical video effect.....	210
Mirror Horizontal video effect.....	210
Luma Key video effect.....	211
Options for resize or key shape effects.....	211
Blend options for Resize and Key Shape effects.....	211
Border options for Resize and Key Shape effects.....	212
Cropping options for Resize effects.....	212
Drop shadows for Resize and Key Shape effects.....	213
Path Control for keyframes.....	214
Chapter 12: Titling and Graphics.....	217
Titling and Graphics Overview.....	218
Using the Title Tool.....	218
Using title templates.....	219
Modifying a template for your sequence.....	220
Advanced titling.....	222
Adding fonts.....	223
The Orad Graphics Tool	223
Configuring Orad in Aurora Edit.....	224
Moving Orad MOS objects into Aurora Edit.....	225
Creating Graphics In Orad.....	226
Preview and Edit Orad Graphics.....	227
The VizRT Graphics Tool	228
Configuring VizRT in Aurora Edit.....	229
Moving VizRT MOS objects into Aurora Edit.....	231
Create VizRT Graphic within Aurora Edit.....	232
Preview VizRT Graphics.....	234
Chapter 13: Sending and exporting output.....	237
Sending sequences.....	238
Associating a sequence with an Aurora Playout placeholder.....	238
Recording completed sequences to tape.....	239
Storing sequences on Aurora Edit.....	241
Creating a playback list.....	241
Playing and organizing sequences in the playback list.....	242
Playing all sequences in the playback list.....	242
Viewing footage while playing a sequence.....	243
Trimming sequences in the playlist.....	243
Loading a playlist.....	243
Changing playback colors.....	244
Modifying playback settings.....	244
Exporting files.....	244
Exporting EDLs.....	245
Exporting a Final Cut Pro EDL.....	246
Exporting effects.....	247
Exporting graphic files.....	247
Exporting media.....	248
Exporting to a removable media device.....	249

Using the Conform Manager.....	250
Appendix A: Software Licenses.....	253
cmemdc.....	254
cping.....	254
CSizingToolBar.....	255
CTextProgressCtrl.....	256
MIT.....	256
mozilla.....	257
Paintlib.....	264
resizeable lib.....	265
tconvert.....	267
zlib.....	267
Glossary.....	269

Grass Valley Product Support

To get technical assistance, check on the status of a question, or to report a new issues, contact Grass Valley Product Support via e-mail, the Web, or by phone or fax.

Web Technical Support

To access support information on the Web, visit the product support Web page on the Grass Valley Web site. You can download software or find solutions to problems.

World Wide Web: <http://www.grassvalley.com/support/>

Technical Support E-mail Address: gvgtechsupport@grassvalley.com

Telephone Support

Use the following information to contact Product Support by phone.

International Support Centers

Our international support centers are available 24 hours a day, 7 days a week.

Support Center	Toll free	In country
France	+800 80 80 20 20	+33 1 48 25 20 20
United States	+1 800 547 8949	+1 530 478 4148

Authorized Local Support Representative

A local support representative may be available in your country. To locate a support center during normal local business hours, refer to the following list. This list is regularly updated on the website for Grass Valley Product Support

(<http://www.grassvalley.com/support/contact/phone/>)

After-hours local phone support is also available for warranty and contract customers.

Region	County	Telephone
Asia	China	+86 10 5883 7575
	Hong Kong, Taiwan, Korea, Macau	+852 2531 3058
	Japan	+81 3 6848 5561
	Southeast Asia - Malaysia	+603 7492 3303
	Southeast Asia - Singapore	+65 6379 1313

Region	County	Telephone
Pacific	India	+91 22 676 10300
	Australia	1 300 721 495
	New Zealand	0800 846 676
	For callers outside Australia or New Zealand	+61 3 8540 3650
Central America, South America	All	+55 11 5509 3440
North America	North America, Mexico, Caribbean	+1 800 547 8949; +1 530 478 4148
Europe	UK, Ireland, Israel	+44 118 923 0499
	Benelux – Netherlands	+31 (0) 35 62 38 421
	Benelux – Belgium	+32 (0) 2 334 90 30
	France	+800 80 80 20 20; +33 1 48 25 20 20
	Germany, Austria, Eastern Europe	+49 6150 104 444
	Belarus, Russia, Tadjikistan, Ukraine, Uzbekistan	+7 095 258 09 20; +33 (0) 2 334 90 30
	Nordics (Norway, Sweden, Finland, Denmark, Iceland)	+45 40 47 22 37; +32 2 333 00 02
	Southern Europe – Italy	Rome: +39 06 87 20 35 28 ; +39 06 8720 35 42. Milan: +39 02 48 41 46 58
	Southern Europe – Spain	+34 91 512 03 50
	Switzerland	+41 56 299 36 32
Middle East, Near East, Africa	Middle East	+971 4 299 64 40
	Near East and Africa	+800 80 80 20 20; +33 1 48 25 20 20

Chapter 1

Introducing Aurora Edit

This section contains the following topics:

- *What is Aurora Edit?*
- *Quick overview of editing with Aurora Edit*
- *Supported formats*
- *Tour of the Aurora Edit window*
- *Aurora Edit tools*
- *The Aurora Edit keyboard*
- *Command pulldown menu*
- *Keyboard shortcuts*

What is Aurora Edit?

Aurora Edit is a digital nonlinear editing solution designed specifically for editing news stories. It replaces record decks and effects switchers by displaying edits in real time.

Nonlinear editing systems provide greater efficiency, accuracy, and flexibility than analog tape-based systems. For instance, you do not need to edit chronologically--you can edit shots in any order without re-recording all of your edits after a change.

Breaking stories can be edited quickly, saved, and then different versions can be cut. Re-editing stories, fixing mistakes, and adding shots in a tape-to-tape environment can require valuable time in a business where time isn't always available. With nonlinear editing, however, changes can be made at anytime during the editing process.

Aurora Edit's unique dynamic display updates automatically to provide you, the editor, with the tools necessary for every edit. Because the audio and video are stored digitally, you can repeatedly use media without duplication or degradation.

Quick overview of editing with Aurora Edit

You create a news or sports story with Aurora Edit in three stages: record footage, edit and fine-tune the story, send the story for playout to air.

1. Record your raw footage or feed directly to the Aurora Edit Timeline or Bin.

You can also import clips and sequences from other third-party sources or other Aurora Edit workstations.

2. Edit the story and fine tune it.

Use basic editing procedures to create simple cuts. Add dissolve, wipe, or slide transitions. Add video effects such as blurs, color effects, or Picture-in-Picture. Adjust the audio or add new audio. Add graphics or titles.

3. Save your final story to a network server, record it to tape for airing, play it directly to air with an Aurora Edit playlist or a playback system like Aurora Playout.

Supported formats

Aurora Edit supports a large variety of audio, video and media formats you can use to create sequences.

Aurora Edit supports these media formats for both NTSC and PAL video standards:

- DV
- DVCAM
- DVCPRO (25/50/100)

- MPEG
- IMX
- AVC-Intra
- JPEG 2000

Aurora Edit supports these video formats:

	Format	Aurora Edit LD	Aurora Edit HD	Aurora Edit HDR
Input	Component			X
	Composite			X
	FireWire, AVC and RMI		X	X
	SDI			X
	S-Video			X
Output	Component			X
	Composite			X
	Dual VGA	X	X	X
	FireWire (IEEE 1394)		X	X
	SDI			X
	S-Video			X

Aurora Edit supports these audio formats:

	Format	Aurora Edit LD	Aurora Edit HD	Aurora Edit HDR
Input	AES-BNC			2/1
	AES-XLR			2/1
	ANALOG-RCA	X	X	X
	ANALOG-XLR			2
	SDI Embedded			8
Output	AES-BNC			2/1
	AES-XLR			2/1
	ANALOG-RCA	X	X	2
	ANALOG-XLR			2
	SDI Embedded			8

Tour of the Aurora Edit window





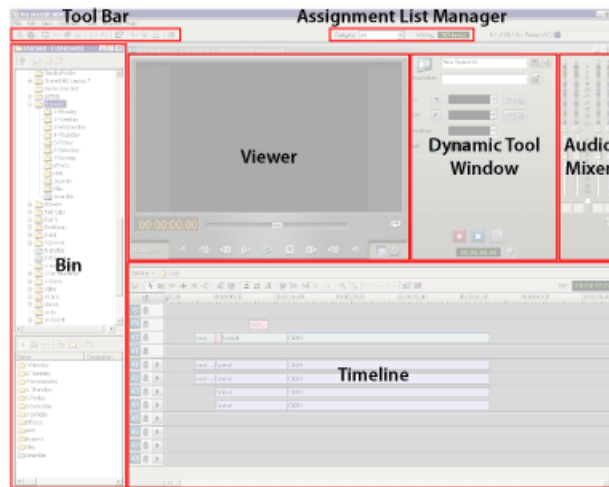

The Aurora Edit window consists of a main toolbar, a Bin to hold files, a record/playback monitor, an audio mixer, an editing Timeline, and a dynamic window that changes depending on the tool selected.







If you are using MediaFrame, you also have a storyboard that display scene detection thumbnails.



Main toolbar

The main toolbar provides access to common Aurora Edit functions.

Button	Name	Function
	Send To File	Sends a clip or sequence to another destination
	Conform Manager	Opens the Conform Manager where you can monitor sends using a Conformance Server
	Transfer Manager	Opens the Transfer Manager window to show status of restored media being transferred between an archive location and the current timeline
	Story View	Displays the script for the selected sequence, if there is one
	Record to Bin	Records clips directly into your Bin
	Play to Tape	Records the selected clip or sequence to tape
	Render Effects	Renders the currently selected transitions or other selected effects

Button	Name	Function
	Render All	Renders all unrendered transitions and effects in the current sequence
	Mix Down	Collapses a video effect into the video track below it, allowing you to apply another effect to the same clip
	Restore Sequence Assets	Invokes a hi-res restore in a sequence where offline lo-res media from archived assets has been added to the active timeline and edited
	Synchronize Restored Assets	A synchronization button that allows the user to manually replace the lo-res media with the hi-res version making the story ready to render or be sent to playout
	Unlink Restored Assets	Unlinks restored assets on the timeline back to proxy references while preserving the timeline for preview, future restore
	Second Monitor	Allows you to view the video window on a second computer monitor

Bin

The Bin is a database where clips and sequences are stored and organized.



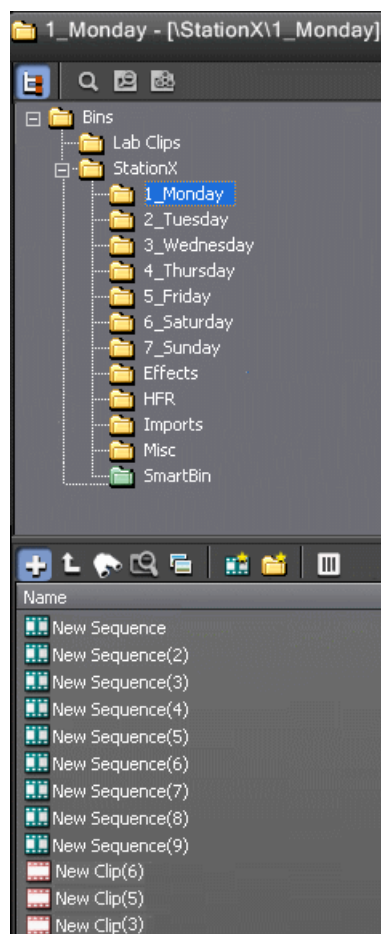

The top-level Bin appears by default when you start Aurora Edit. You create additional bins to organize your media. You can also customize the information about each clip and then search specific fields in the database.

If you are using MediaFrame, you have more searching and organizing capabilities.











Bin toolbar

The Bin toolbar lets you view and organize the folders in your database, as well as search for clips.

Button	Name	Description
	Tree View	Lets you toggle between seeing the entire Bin structure and seeing contents of a selected Bin
	Search	Allows you to search your database for clips and metadata assets
	Explore	Allows you to browse your network and save network locations
	Collections	Lets you organize and sort clips in the Bin for easy access

Bin contents toolbar

The Bin contents toolbar lets you access common Bin functions.

Icon	Name	Description
	Bins	View the content of the selected Bin, not all Bins in tree view
	Up One Level	View the bins at the next highest level
	Find in View	Opens the bin Find in View search function
	Search Results	Shows bin search results in bin contents as list or thumbnail view
	View Thumbnails	Toggle between displaying your clips and sequences as text or as thumbnails
	New Sequence	Create a new sequence in your bin
	New Bin	Create a new bin
	Column Manager	Select the columns to view in your bin; only available when viewing bin contents as text, not as thumbnails

Timeline





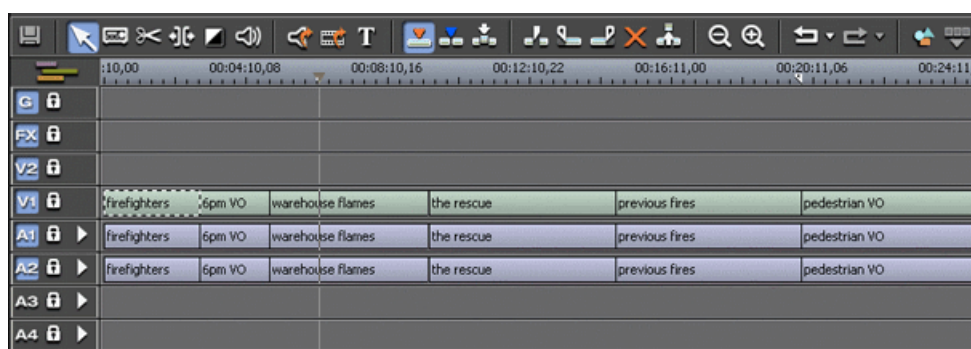













The Aurora Edit Timeline is an all-purpose editing window that replaces a record deck in the editing process.



The Timeline provides a graphic representation of your sequence in a single window, displaying its tracks, the name of each clip, and the current frame's location.



Timeline toolbar

The Timeline has its own toolbar, which provides access to each of the Aurora Edit tools, lets you select your editing mode, and other common Timeline functions.

Button	Name	Description
	Save	Saves your sequence in the Bin
	Auto-Scale On/Off	Timeline Auto-Scale is on
		Timeline Auto-Scale is off
	Timeline Tool	Selects the Timeline Tool
	Source Tool	Selects the Source Tool
	Trim Tool	Selects the Trim Tool
	Cut Point Edit Tool	Selects the Cut Point Edit Tool
	Transition Tool	Selects the Transition Tool
	Audio Mixer Tool	Selects the Audio Mixer Tool
	Audio Effects Tool	Selects the Audio Effects Tool
	Video Effects Tool	Selects the Video Effects Tool
	Title Tool	Selects the Title Tool (option)
	Overwrite Mode	Selects Overwrite Edit Mode
	Splice Mode	Selects Splice Mode
	Fit To Fill	Activates Fit To Fill
	Split Clip	Splits a clip at the cursor point
	Cut Mark In	Trims the top of the selected clip on the Timeline
	Cut Mark Out	Trims the tail of the selected clip on the Timeline
	Delete Selected	Deletes selected clips
	Lift	Lifts selected clips off the Timeline
	Zoom In	Zooms in on the view in the Timeline
	Zoom Out	Zooms out on the view in the Timeline
	Undo	Undoes the latest action

Button	Name	Description
	Redo	Redoes the latest action
	Sequence Properties	Opens the Sequence Properties window
	Show/Hide Storyboard	Toggles the display of the Storyboard

Dynamic tool window

The dynamic tool window changes functionality based on the Aurora Edit tool you select.

Each Aurora Edit tool lets you create, edit, refine, and enhance your sequences as you create stories for playing to air.

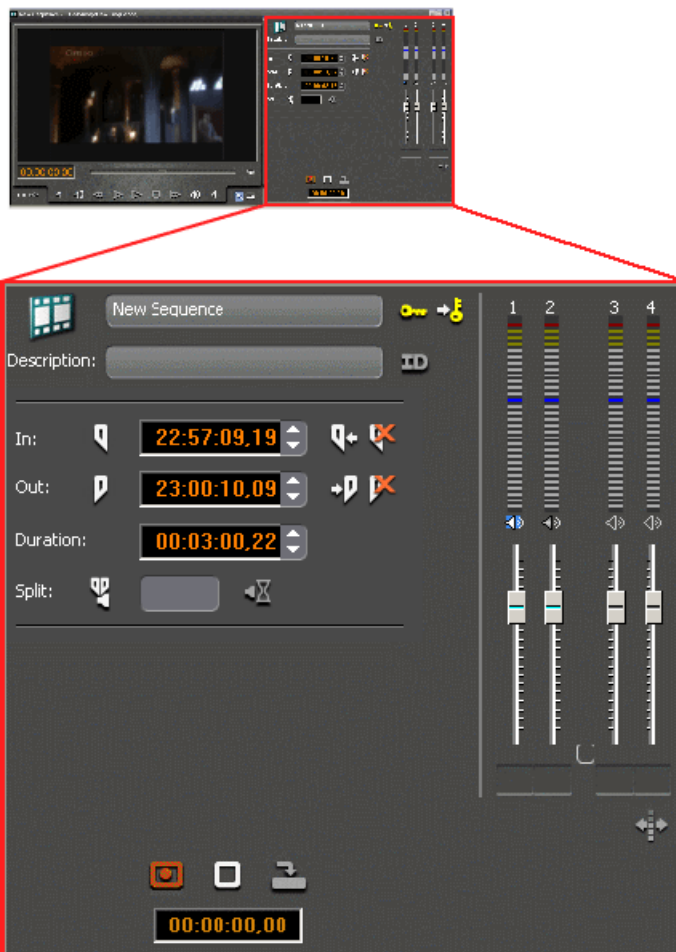

Viewing monitor

The viewing monitor is where you view your media, play through a clip to find footage, and play your sequence.



Storyboard

The storyboard displays video thumbnails of scene changes in your media, providing an easy way to see what the clip includes.

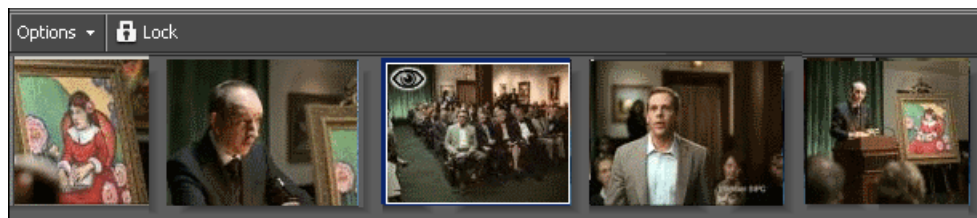

You can have the storyboard display in your Aurora Edit timeline or you can hide it by clicking the  **Show/Hide Storyboard** button in the Timeline toolbar.

Audio mixer

The audio mixer lets you adjust audio output levels, gang audio tracks, and mute channels.

Six of Aurora Edit's tools contain the audio mixer:

- Timeline Tool
- Source Tool
- Trim Tool
- Transition Tool
- Audio Mixer Tool
- Audio Effects Tool

For further audio editing capabilities, use the Audio Mixer Tool or the Audio Effects Tool.



The Assignment List Manager

The Assignment List Manager is for editors to receive assignments from the producer, to create additional placeholders for clips, and to reassign placeholders to other editors.

The Assignment List Manager runs on the Aurora Edit workstation and integrates with Aurora Edit. The Aurora Edit toolbar displays part of the Assignment List so editors can see at a glance how many stories need video.

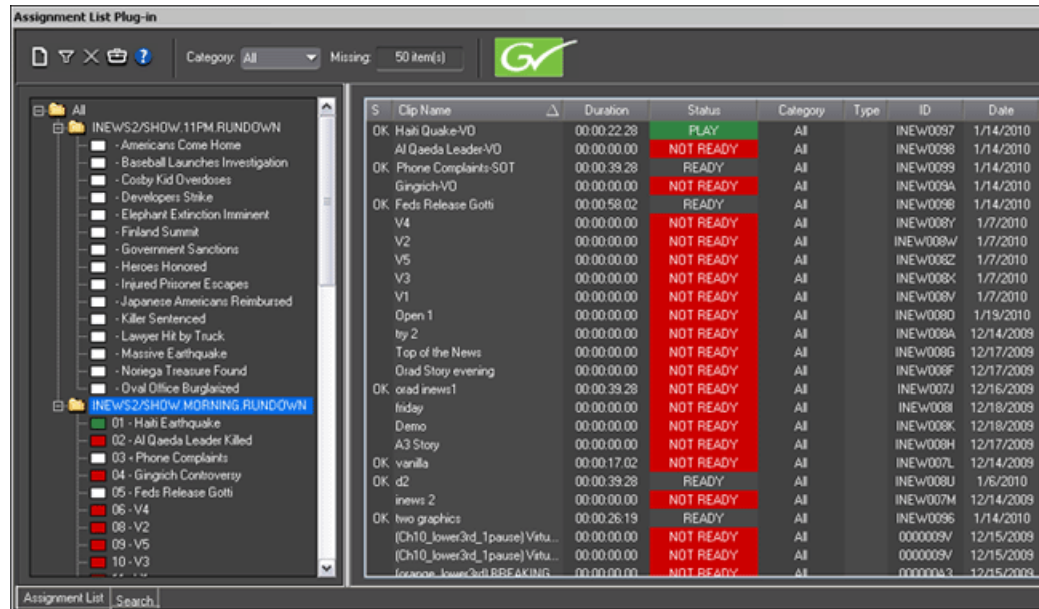

Aurora Edit tools

Each of the nine Aurora Edit tools displays in the dynamic window, leaving the Timeline unchanged. You select the tools from the Timeline toolbar.

Timeline Tool

The Timeline Tool  opens by default when you first create a sequence. You can select and move clips or audio tracks, play sequences, mark in and out points, and adjust master output audio sliders.

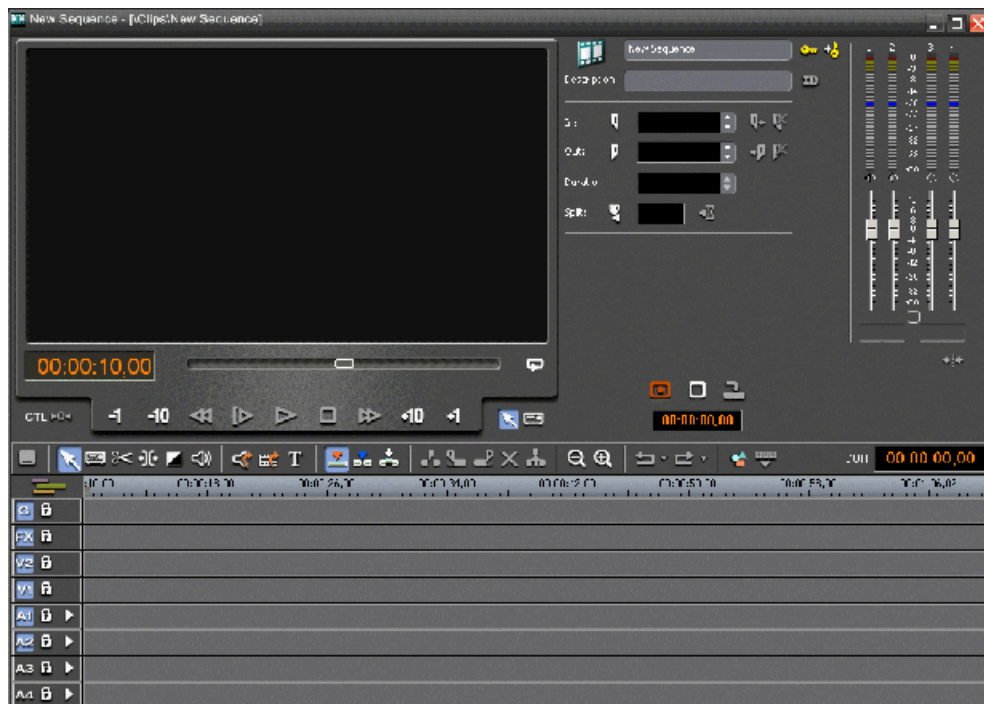

Source Tool

The Source Tool  digitizes raw material directly to the Timeline.

This is the fastest and most efficient way to generate clips from a source tape. You can also use other sources for your footage, such as video feeds or microphones.

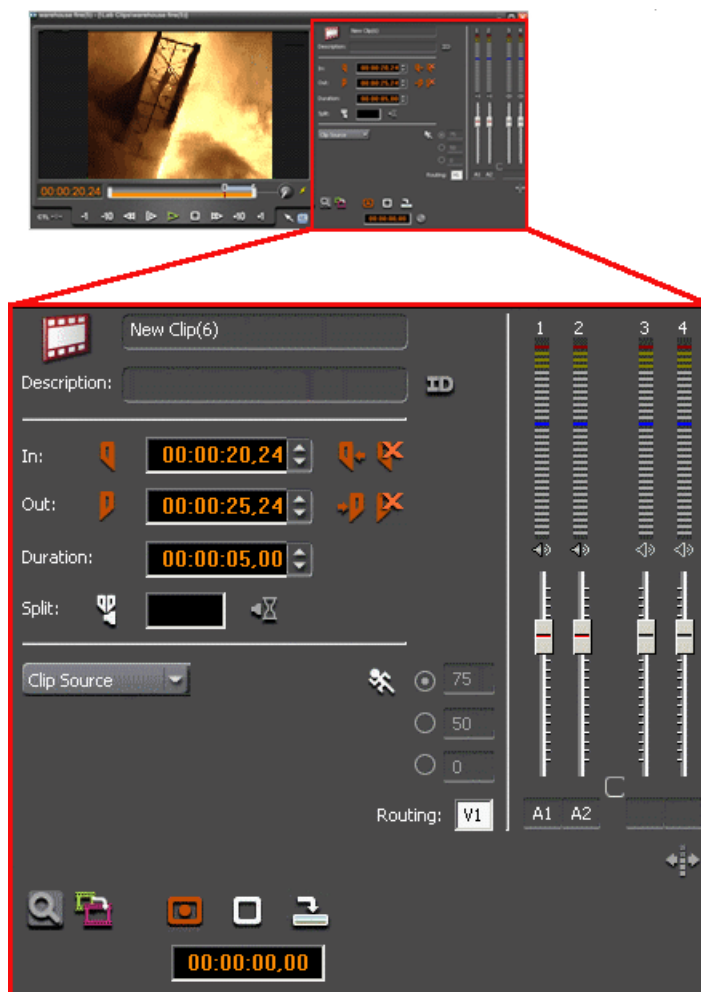

Trim Tool

The Trim Tool  changes the head or tail of a clip to change its duration.

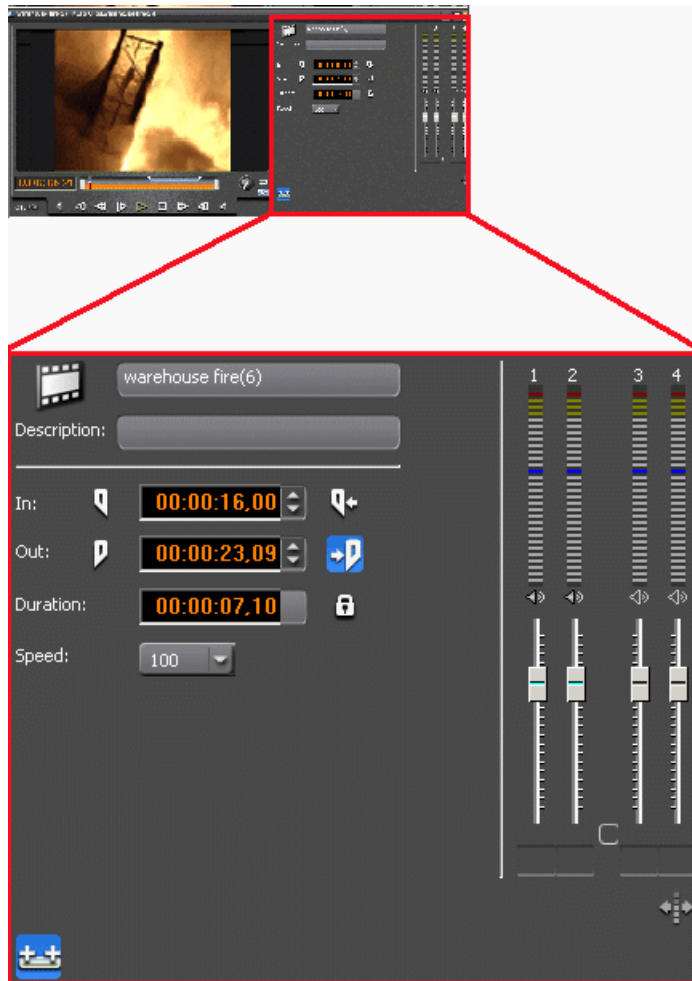

Cut Point Edit Tool

The Cut Point Edit Tool  changes the edit points between clips in the Timeline.

You can easily create split edits by only selecting audio or video. If you have handles on your clips, you can access unused portions of a clip without returning to the source tape and redoing the edit.

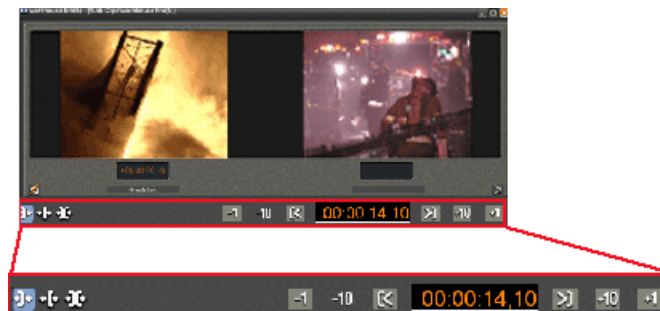

Transition Tool

The Transition Tool  creates transition effects between clips in a sequence.

You can create dissolves or wipes between any two edits by selecting the transition you want and clicking at the point you want the effect to appear.

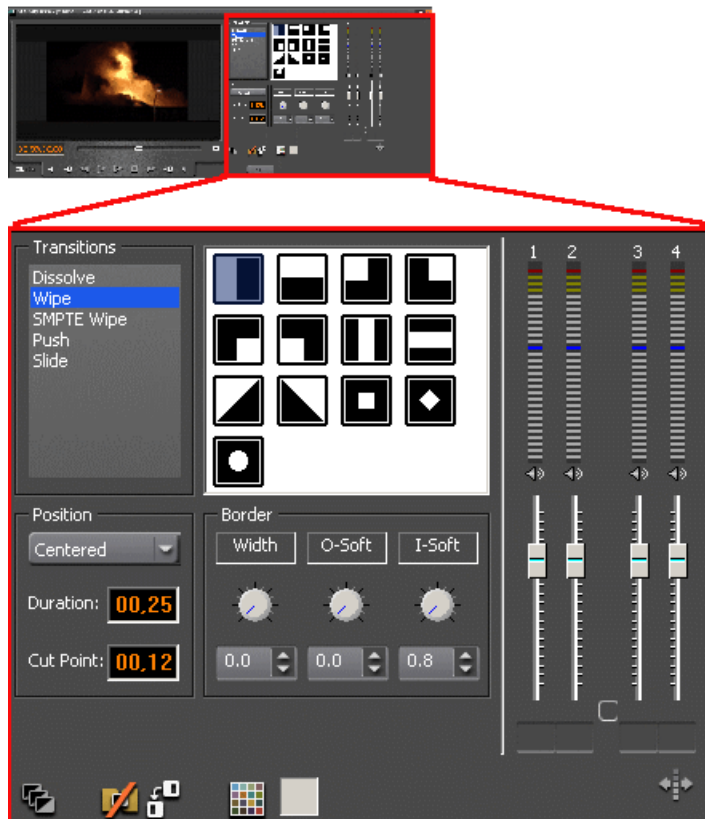

Audio Mixer Tool

The Audio Mixer Tool  adjusts the audio settings in a sequence, including the level, the pan, and output channel routing.

You can raise or lower the audio on each audio track, or ride the audio on the fly using the Write Automation option.

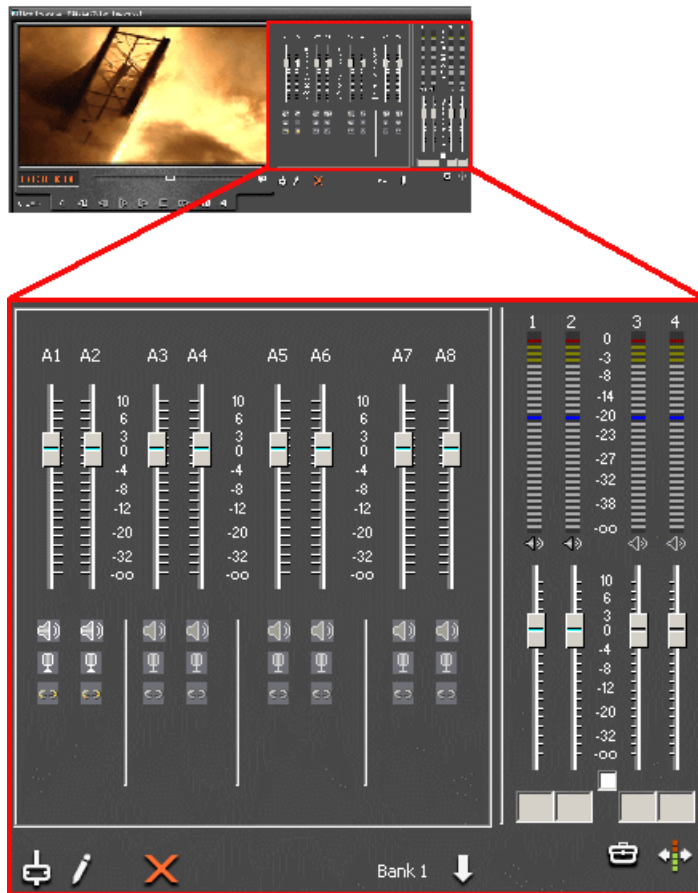

Audio Effects Tool

The Audio Effects Tool  adjusts the frequency and gain within a clip by adjusting the audio EQ.

For instance, you could disguise a subject's face and voice by modifying the audio and using a mosaic or blur effect for video.

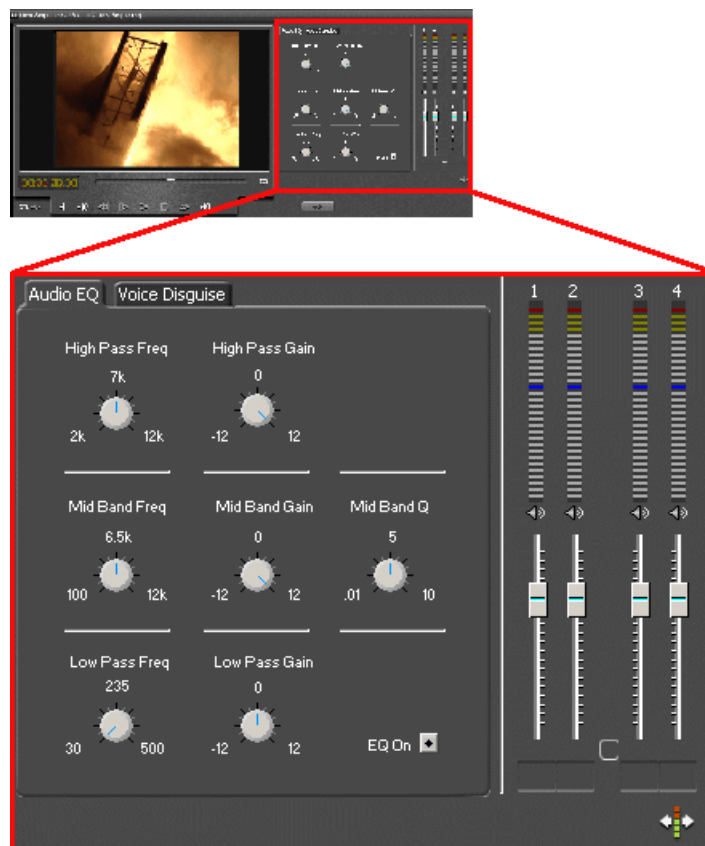

Video Effects Tool

The Video Effects Tool  creates effects for one or two video tracks, depending on the effect.

An effects track on the Timeline lets you create the effect using keyframes and review the clip with the effect applied to it.

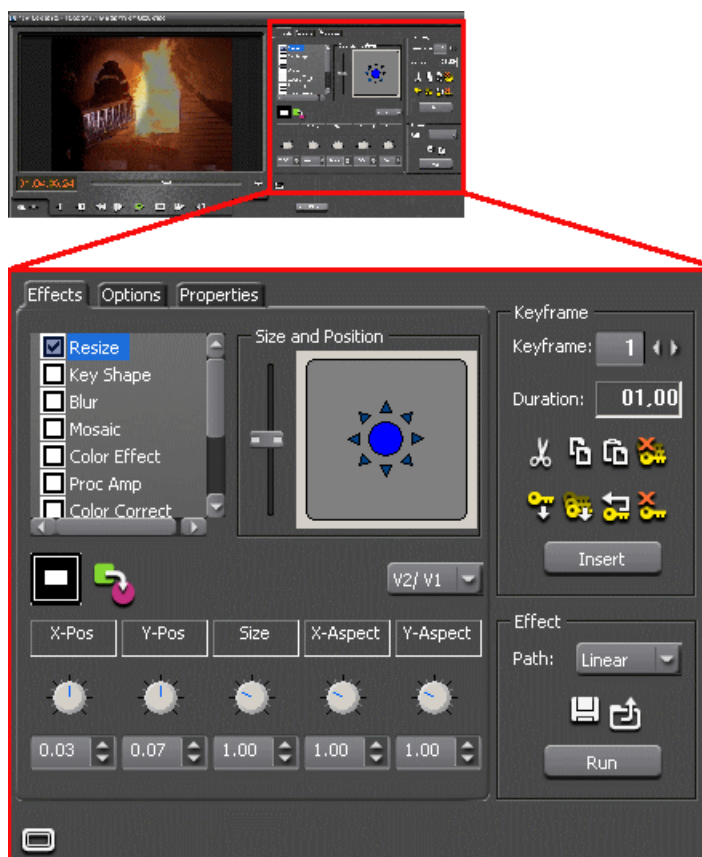

Title Tool

The Title Tool is optional **T** and adds text and graphics to your sequences.

A graphics track on the Timeline lets you create the effect, modify its properties, and review the clip with the title applied to it.

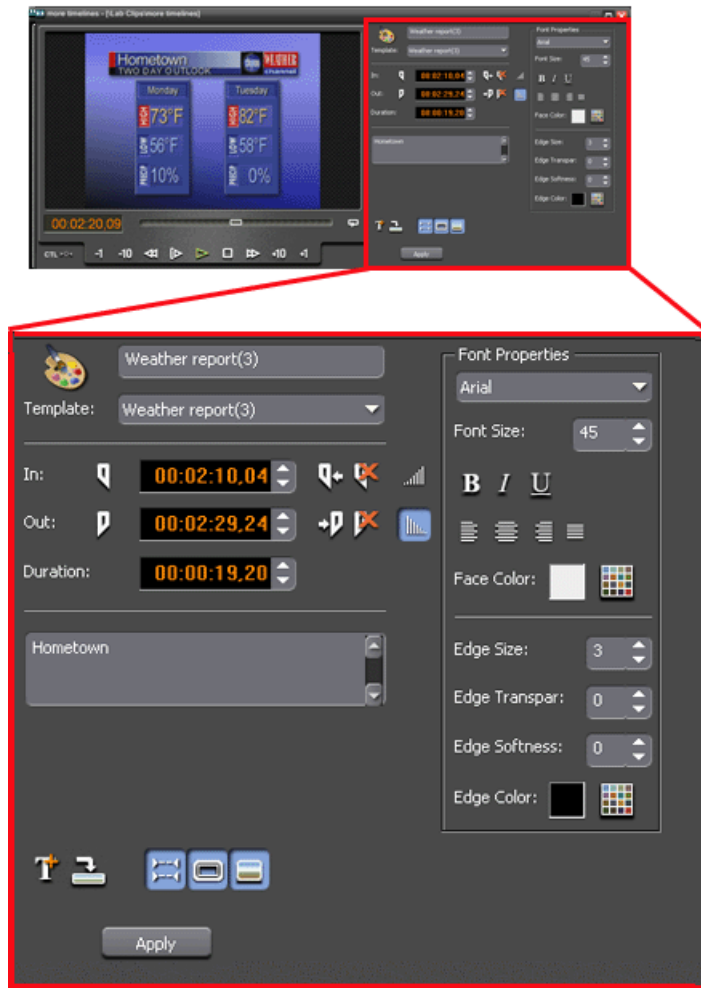

Graphic Tools

Both Aurora Edit and Aurora Edit LD can interface with two powerful graphic system options, Orad or VizRT. Plug-ins available from each graphic system basically allow the journalist to link graphics to scripts as MOS objects and the editor to link to these scripts and copy the graphics directly to the Timeline.

The Orad system has an end-to-end workflow with integration from the journalist's desktop directly to playout on air. From Aurora Edit, editors can link to these scripts and copy graphics directly to the Timeline. Once the graphic is on the Timeline, the editor can preview the graphic and has the same add/modify capabilities as the journalist within the Orad plug-in.

Aurora Edit will embed timing information for graphics triggering from Aurora Playout. The Orad graphics engine will then be given a command from Aurora playout to play the graphics at certain times throughout the story. The video output of the Orad graphics system will then be routed through the switcher for overlay on the video.

The VizRT system allows integration from the journalist's desktop directly to the Timeline. From the journalist desktop, VizRT has a plug-in that allows operators to access, add, or modify graphics that can then be linked to scripts as MOS objects. From Aurora Edit, editors can link to these scripts and copy the graphics directly to the Timeline. Editors can preview the graphic from within Aurora Edit using the VizRT plug-in and have the same add/modify capabilities as the journalist.

Once a graphic is ready on the Timeline, the editor can retrieve the graphic. This then communicates with the VizRT graphics server and pulls the proper graphic file into Aurora Edit as a video file with Alpha. The editor can then transfer to playout with the burned-in graphic already on the Timeline.

NOTE: Check the Aurora Edit and Aurora Edit LD Release Notes for the specific plug-in versions required for the Orad and VizRT system that are compatible with this software release.

In addition to the optional graphic tools, Aurora Edit and Aurora Edit LD can import 24- or 32- bit still or sequential (Aurora Edit only) graphic files for placement on the Timeline graphics track from the **File | Import | Graphic** pulldown in the main menu bar.

The Aurora Edit keyboard









Most Aurora Edit functions can be controlled from a standard keyboard. Color-coded keypad stickers supplied with each Aurora system can be applied to the keycaps that correspond to Aurora Edit functions, allowing you to edit more quickly and easily.

A set of color-coded keypad stickers is included with each Aurora Edit software disk. The keypad sticker set allows any standard keyboard to be updated to an Aurora Edit keyboard. Also use the stickers to update an existing Aurora Edit keyboard that already has permanent colored-coded keypads if necessary.

Tool selection keys

The eight light blue keys at the top of the keyboard activate the Aurora Edit tools.















Keypad	Name	Function
	Timeline Tool	Selects and moves items on the Timeline
	Source Tool	Views the source
	Trim Tool	Trims Mark In and Mark Out points in clips
	Cut Point Edit Tool	Trims the cut points between adjacent clips (Edit HD only)
	Transition Tool	Add transition effects to clips
	Audio Mixer Tool	Adjust the audio tracks in clips
	Audio Effects Tool	Adjusts the Audio EQ in clips and disguises voices (Edit HD only)
	Video Effects Tool	Creates video effects to use on clips, such as blurs and Picture-in-Picture

Transport command keys

The light purple keys act as transport controls for playing sequences and remote sources. The green keys control movement within a clip. The red key **F12** starts a record.













Keypad	Name	Function
	Play	Plays the Timeline, source or clip
	Play From Start	Plays sequence or clip starting at the beginning

Keypad	Name	Function
	Play	Plays the Timeline, source or clip
	Rewind	Rewinds the footage for both Timeline and source
	Fast Forward	Fast forwards the footage for both Timeline and source
	Record	Starts recording from source or source bin
	Back 1 Frame	Moves cursor one frame back on the Timeline
	Forward 1 Frame	Moves cursor one frame forward on the Timeline
	Back 10 Frames	Moves cursor 10 frames back on the Timeline
	Forward 10 Frames	Moves cursor 10 frames forward on the Timeline
	Previous Cut Point	Moves cursor to the previous cut point
	Next Cut Point	Moves cursor to the next cut point

Editing and clip/track selection keys

The tan keys perform trims. The blue keys represent edit modes for overwrite, splice, and fit-to-fill. The dark gray key performs copy to Timeline. The purple keys control clips. The gray keys are used with Aurora Edit local searches (not MediaFrame).









Keypad	Name	Function
	Trim Mark Out	Trims the Out point in the Cut Point Edit Tool; changes the duration of the sequence (Edit HD only)
	Trim Mark In	Trims the In point in the Cut Point Edit Tool; changes the duration of the sequence (Edit HD only)
	Trim Both	Trims both the In and Out points in the Cut Point Edit Tool; doesn't change the duration of the sequence (Edit HD only)
	Overwrite Mode	Allows you to overwrite clips to the Timeline
	Splice Mode	Allows you to splice clips to the Timeline
	Fit To Fill	Lets you create fit to fill clips
	Copy To Timeline	Copies selected clips from Bin as well as Timeline clip sources to the Timeline. In the Record to Bin window, adds a clip to the Batch Capture list.
	Match Frame to Bin	Copies selected clips from Bin as well as Timeline clip sources to the Timeline. In the Record to Bin window, add a clip to the Batch Capture list.
	Mark Area	Marks an in and out around the selected areas of the Timeline
	View Search Results	Displays the results bin for local Aurora Edit searches (not MediaFrame searches)
	Find	Searches for assets within the local Aurora Edit database (not the MediaFrame Asset Management database)

Mark point keys

The dark purple keys set and control the mark In and Out points. The gray keys are used with keywords in MediaFrame.









Keypad	Name	Function
	Add Keyword (in MediaFrame)	Adds a keyword into the MediaFrame metadata view for quick recall throughout the system
	Automark Keyword (in MediaFrame)	Automatically marks a keyword from the current position of the cursor along with a configurable duration. The duration is set though the settings option with the MediaFrame metadata view.
	Cut Mark In Refresh	Cuts the beginning of the clip (the top) off the selected clips on the Timeline; in the Bin, refreshes bin folders and displays any newly imported files
	Cut Mark Out	Cuts the end of the clip (the tail) off the selected clips on the Timeline
	Go to Mark In	Moves to the Mark In point
	Go to Mark Out	Moves to the Mark Out point
	Mark In	Marks an In point
	Mark Out	Marks an Out point
	Clear Mark In	Clears the In point
	Clear Mark Out	Clears the Out point
	Extend Edit	Extends an edit past the end of the clip using handles
	Timecode/Control Track	Toggles between Timecode and Control Track modes

Keypad	Name	Function
	Reset Control Track	Resets the Control Track to 00:00:00:00
	Move Clip Previous Cut Point	Move the selected clip to the previous cut point
	Move Clip Next Cut Point	Move the selected clip to the next cut point

Track selection keys

The light gray keys zoom the Timeline in and out. The bright blue keys toggle audio and video tracks on and off.



















Keypad	Name	Function
	Zoom out	Zooms the view in the Timeline out
	Zoom in	Zooms the view in the Timeline in
	Video 1	Toggles video track V1 on and off
	Audio 1	Toggles audio track A1 on and off
	Audio 2	Toggles audio track A2 on and off
	Audio 3	Toggles audio track A3 on and off
	Audio 4	Toggles audio track A4 on and off

Other Aurora Edit keys

The keys described below perform miscellaneous editing functions.



Keypad	Name	Function
	Send	Lets you send a clip or sequence to another destination
	View Metadata	Display and access MediaFrame metadata for the loaded clip
	Collapse Sequence	Collapses a clip in a sequence to close a gap between media
	Lift Selection	Lifts the selected clip out of the sequence, leaving black and silence
	Split Clip	Splits the selected clip at the cursor point
	Enable Vary Speed	Enables variable speed controls in the Source Tool
	Insert Keyframe	In the Video Effects Tool, adds a keyframe to the currently selected effect
	Go to Start	Moves the position to the beginning of a clip or sequence
	Previous Vary Speed	In the Source Tool or Trimmer, selects the previously set variable speed
	Delete Selection	Deletes the selected clip from the Bin or Timeline

Keypad	Name	Function
	Go to End	Moves the position to the end of a clip of sequence
	Next Vary Speed	In the Source Tool or Trimmer, selects the next variable speed
	Shuttle Rewind	Shuttles left in increments of -50%, -75%, -1x, -2x, -3x
	Shuttle Fast Forward	Shuttles left in increments of +50%, +75%, +1x, +2x, +3x
	Shuttle Default Speed	Resets the shuttle speed to its default speed
	Shuttle Previous Speed	Selects previous shuttle speed

Command pulldown menu

Most Aurora Edit functions can be controlled directly by the Commands listed in the Commands menu pulldown in the top menu bar.



The Commands pulldown lists the functions available and the keyboard shortcuts that correspond to each function. The pulldown will appear in the top menu bar when any editing function view such as Timeline, Record to Bin, Trimmer, Playback Channel and other editing windows are open.

Most Commands have a corresponding keyboard shortcut to perform the same function.

Related Links

[Keyboard shortcuts](#) on page 42

Keyboard shortcuts

Keyboard shortcuts let you perform tasks more quickly and efficiently by using the keyboard instead of pointing and clicking with the mouse.

Aurora Edit keyboard shortcuts

To do this...	Use this key...
Collapse a sequence	0
Cut a mark in point	F5
Cut a mark out point	F6
Delete an area	Ctrl + Del
Delete a selection	Del
Deselect all	Shift + D
Extend an edit	V
Insert filler	Ctrl + Shift + F
Lift an area	Ctrl +]
Lift a selection]
Match frame to Bin	M
Match frame to source	Shift + F4
Mixdown selected	Shift + M
Move a selection	Ctrl + M
Render all	Shift + V
Render selected	Ctrl + Shift + R
Select all	Shift + S
Split a clip	\

Edit setup keyboard shortcuts

To do this...	Use this key...
Add handles	Shift + ~
Auxiliary input	Ctrl + A
Clear all mark points	Alt + P
Clear audio in	Shift + P
Clear audio out	{
Clear mark in	P
Clear mark out	[

To do this...	Use this key...
Fit to fill	F11
Go to mark in	Ctrl + I
Go to mark out	Ctrl + O
Mark area	Ctrl + F4
Mark audio in	Shift + I
Mark audio out	Shift + O
Mark in	I
Mark out	O
Overwrite mode	F9
Quick edit	Ctrl + 2
Record	F12
Reset control track	N
Show audio marks	Shift + A
Splice mode	F10
Stop record	space
Timecode/control track	B

Selecting and moving keyboard shortcuts

To do this...	Use this key...
Move clip left 1 frame	Numpad 4
Move clip left 10 frames	Ctrl + numpad 4
Move clip to the next cut point	X
Move clip to the previous cut point	Z
Move clip right 1 frame	Numpad 6
Move clip right 10 frames	Ctrl + numpad 6
Select next	Alt + ,
Select the next track	Alt + /
Select previous	Alt + M
Select the previous track	Alt + .

Play speed keyboard shortcuts

To do this...	Use this key...
Enable vary speed	Pause
Next vary speed	Page down
Previous vary speed	Page up

Tracks keyboard shortcuts

To do this...	Use this key...
Audio 1	K
Audio 2	L
Audio 3	;
Audio 4	'
Audio 5	Ctrl + K
Audio 6	Ctrl + L
Audio 7	Ctrl + ;
Audio 8	Ctrl + '
Effects track (FX)	Ctrl + 8
Graphics track	Ctrl + G
Sync lock A1	Shift + K
Sync lock A2	Shift + L
Sync lock A3	:
Sync lock A4	"
Sync lock A5	Ctrl + Shift + K
Sync lock A6	Ctrl + Shift + L
Sync lock A7	Ctrl + Shift + ;
Sync lock A8	Ctrl + Shift + '
Sync lock V1	Shift + J
V1	J
V2	Ctrl + J

Transports keyboard shortcuts

To do this...	Use this key...
Back 1 frame	A
Back 1 second	Ctrl + D
Back 10 frames	D
Eject	Ctrl + Q
Fast forward	R
Forward 1 frame	S
Forward 1 second	Ctrl + F
Forward 10 frames	F
Go to end	End
Go to start	Home
Next cut point	H
Play	W
Play from start	Q
Previous cut point	G
Reverse play	Shift + W
Rewind	E
Shuttle default speed	Up arrow
Shuttle fast forward	Right arrow
Shuttle previous speed	Down arrow
Shuttle rewind	Left arrow
Stop	space

Video effects keyboard shortcuts

To do this...	Use this key...
Add an effect	Shift + 8
Delete all keyframes	Shift + Del
Insert a keyframe	Ctrl + Insert
Modify all keyframes	Shift + insert
Modify a keyframe	Alt + insert

To do this...	Use this key...
Next keyframe	Page down
Previous keyframe	Page up
Run the effect	Ctrl + W

MediaFrame keyboard shortcuts

To do this...	Use this key...
Add Keyword	F3
Add Keyframe	Insert
Automark Keyword	F4

Working in the Bin

This section contains the following topics:

- *About the Bin window*
- *Creating a new bin*
- *How to organize your Bins*
- *Saving the Bin position*
- *Working in shared or local mode*
- *Viewing clips in your Bin*
- *Working with clips in the Bin*
- *SmartBins*

About the Bin window

The Bin window consists of two main components — a toolbar and the area that holds your files. The toolbar lets you create new bins and sequences, search for specific files, and change the way you view bins.

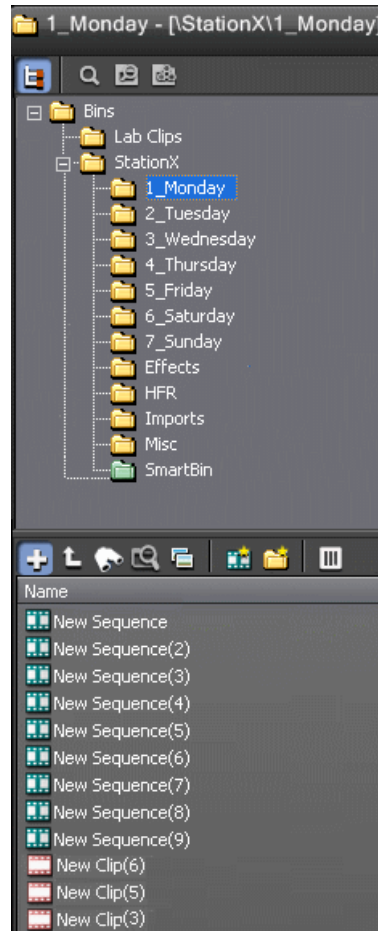

Creating a new bin

The Bin window is empty when you open Aurora Edit for the first time. Before you can begin using Aurora Edit, you need to create bins to store your work.

You can create and organize your bins to suit your work style. For instance, you could create a bin for each day of the week and within those set up a bin for each individual story or for each editor.

1. Click the  **New Bin** button on the Bin contents toolbar.

The Bin Properties window appears.

2. Enter the bin Name.
3. Enter a bin Description and Keywords (optional).

You can use the keywords to search for a specific bin.

4. Click **Browse** and select a location for the Bin, if different than the default.
5. Click **OK**.

Related Links

[Understanding SmartBins](#) on page 58

How to organize your Bins

There are several ways to organize your bins, and the organization you choose depends mostly on your job function as well as your organizational style.

A typical setup might be:

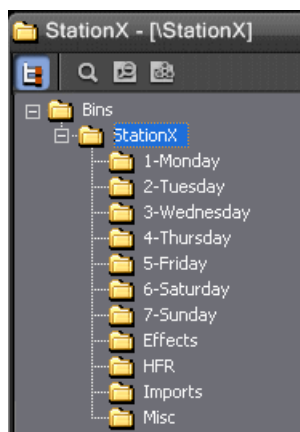

Name of Bin	Description
1-Monday to 7-Sunday	Used for everyday stories
Effects	Holds saved video effects
HFR (Hold For Release)	Used when you are editing a story on one day but airing it on another
Imports	Set up as a single location where other Aurora Edit workstations can send clips over the network to you
Misc.	Holds any clips to be saved, such as Whiteflash, Black, Color Bars and Tone, Reporter Outcues, repeated effects, etc.

It is also important that, within each day of the week, you create another bin with the title of the specific project you are working on. This helps to keep the bins organized, especially with more than one editor working on the same Aurora Edit system.

Aurora Edit automatically monitors your bins and refreshes the display if anyone places a file in one of your bins. For instance, as a breaking story develops, station staff can place the latest footage in a given directory. It then appears in your Bin where you can use it in your sequence.

NOTE: *In order to create directories, an Aurora Edit LD client must be able to connect to the storage volume. This may be on the hi-res storage or proxy storage. If access is denied, an asterisk will appear next to the bin.*

Saving the Bin position

In Aurora Edit, you can create a workspace that remains each time you open and close the application.

- Choose **Window | Save Bin Postions.**

Your Bin position is saved. Each time you open Aurora Edit, the Bin opens in this position.

Working in shared or local mode

Aurora Edit lets you use a shared media database or your computer's storage and a local database.

You can use Aurora Edit either in shared or local mode.

Shared mode Uses a shared media database. All Aurora Edit workstations access the same bins; the bins are locked so two editors can't make changes to the same file at the same time.

Local mode Uses your computer's local disk storage and a local media database. Each Aurora Edit workstation has its own Bin on the Aurora Edit machine, and cannot share the Bin. In order to use someone else's files, you need to import them into your Bin.

Aurora Edit indicates your current mode at the top of the window.

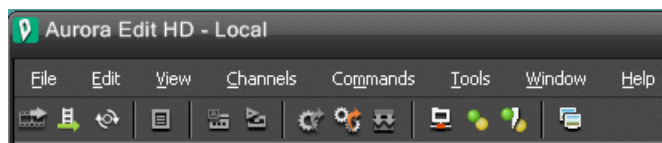

You create sequences in Aurora Edit the same way regardless of what mode you are working in. The main difference is that in shared mode all editors using an Aurora Edit workstation have access to the same media files you do, according to security settings.

Viewing clips in your Bin

Viewing Bins in details view

In this view, each clip or sequence is represented by an icon, the name of the file, and other information about the file, such as timecode, description, and keywords.

The information acts as a database that you can customize by entering information about your clips. You can also search the information for clips that match certain criteria.

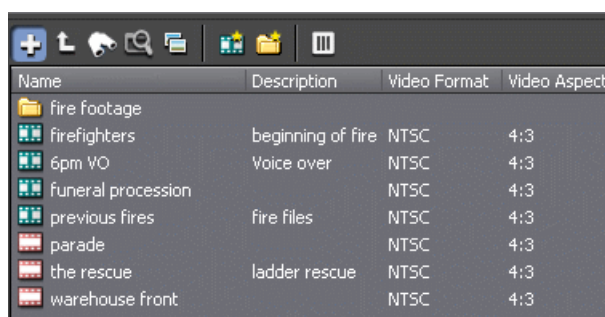

Name	Description	Video Format	Video Aspect
fire footage			
firefighters	beginning of fire	NTSC	4:3
6pm VO	Voice over	NTSC	4:3
funeral procession		NTSC	4:3
previous fires	fire files	NTSC	4:3
parade		NTSC	4:3
the rescue	ladder rescue	NTSC	4:3
warehouse front		NTSC	4:3

Related Links

[Viewing Bins in thumbnail view](#) on page 55

Displaying columns

You can hide or display multiple text columns in the Bin.

1. Click the  **View Thumbnails** button in the Bin Toolbar, if you need to change to thumbnail mode.
2. Click to select a Bin; the contents display in the window below.

If you are in the highest-level bin, you will not see all of the column choices.

3. Click the  **Column Manager** button in the Bin Toolbar.
4. Select the columns you want to display or click the **Reset** button to display all of the columns.
 - Name — Displays the name of the clip or sequence.

- Description — Displays the description of the clip or sequence.
- Keywords — Displays any keywords entered; keywords help to identify and search for specific clips.
- Created — Displays the date the clip or sequence was created.
- Folder — Displays the directory where the clip files are stored.
- Duration — Displays the length of the clip or sequence.
- Mark In — Displays the Mark In timecode.
- Mark Out — Displays the Mark Out timecode.
- Video Format — Displays the video format used for the media.
- Video Aspect — Displays the video aspect for the media, 4:3 or 16:9.
- Video Resolution — Displays the video resolution for the media.
- Compression — Displays the video compression type for the clip or sequence; e.g., DV25, DV50, MPEG2, IMX30, IMX40, IMX50.
- Chroma Format — Displays the chroma ratio for the media, 4:1:1, 4:2:0 or 4:2:2.
- Tracks — Displays the tracks present in the clip.
- Tape ID — Displays the name of the source VTR tape where the media in this clip came from.
- Modified — Displays the date of the last time the clip was modified.
- Status — Displays the clip status: All, Good, Bad, or Marked.
- Audio Format — Displays the audio bit depth: 16-bit PCM or 24-bit PCM.

A checkmark appears next to the selected options.

5. Click **OK**.

The Bin displays your new column choices.

Sorting your media files

You can arrange clips in numeric or alphabetical order according to the columns you select.

For example, you can sort the Bin by the Mark In column to display all of the clips in timecode order.

1. Click the heading of the column by which you want to sort the Bin.

The clips and sequences display in alphabetical or numerical order depending on the column you selected.

2. Click the column again to reverse the order of the sort.

3. Right-click in the Bin and select **Restore Default Sort** to return to the original sort order.

Viewing Bins in thumbnail view

The Thumbnail view provides a visual representation of the type of media file in each bin. Each clip or sequence is represented by a single frame, allowing you to see the content of the material.

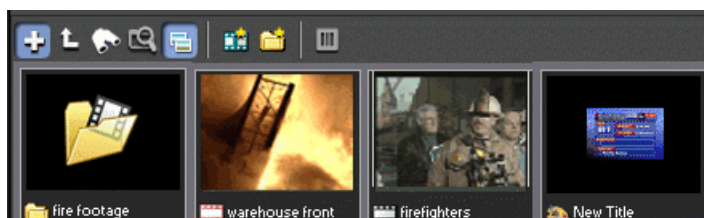

Related Links

[Viewing Bins in details view](#) on page 53

Changing thumbnail size

Aurora Edit offers two thumbnail sizes in this view: 4:3 (SD) and 16:9 (HD).

1. Click the  **View Thumbnails** button on the Bin Toolbar.
2. Choose the thumbnail size you want from the View menu.

Selecting the head frame

Aurora Edit allows you to change the head frame for your media.

Each clip or sequence in Thumbnail view is represented by a single frame, called the head frame. By default, Aurora Edit uses the first frame from the clip or sequence. However, you can choose any frame within the clip or sequence to represent the file in the view.

1. Double-click the clip or sequence to open it.
Clips open in the Trimmer window; sequences open in the Timeline Tool.
2. Play through the clip until you find the frame you want to use.
3. Click  **Set Head Frame From Current Frame**.
4. Click **OK**.

Working with clips in the Bin

Searching for a clip or sequence

You can search for clips and sequences in the Bin. You can search for all clips that meet specific criteria or for a specific clip.

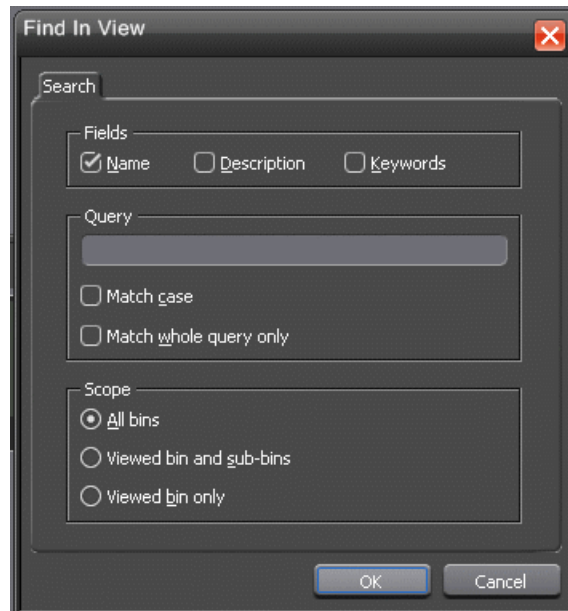

1. Select **Tools | Find**.



The Find In View window appears.

2. Choose the appropriate options:

- **Fields** — Check the boxes for the field(s) on which you want to search (Name, Description, and Keywords).
- **Query** — Enter the text you want to search for.
- **Match case** — Check this checkbox to do a case-sensitive search.
- **Match whole query only** — Check this checkbox to search only for clips with text matching the query text exactly.
- **All bins** — Select this option to search all Aurora Edit bins.
- **Viewed bin and sub-bins** — Select to search all of the bins within the bin you selected.
- **Viewed bin only** — Select to search the bin you are currently viewing.

3. Click **OK**.

Clips and sequences matching your search result appear in the Bin window.

When you are done with your search, click the  **Search Results** button off to restore the normal bin view and allow you to continue working in the Bin. To see your search results again, click the **Search Results** button to its ON position  (blue).

Copying a clip or sequence

You can copy clips and sequences between bins.

If you copy a master clip, Aurora Edit pastes it as a subclip.

1. In the Bin, select the item you want to copy.
2. Right-click on the item and choose **Copy**.
3. Open the bin where you want to paste the item.
4. Right-click and choose **Paste**.

Moving a clip or sequence

You can move clips or sequences from one bin to another.

1. Choose **View | Bins** to open a second Bin window.
2. In the second Bin window, navigate to the destination bin.
3. Drag the sequence or clip from the first Bin window to the second.

Renaming bins and media files

You can change the name of any bin, clip or sequence.

1. Select the item you want to rename.
2. Choose **Edit | Rename**.

You can also press **Shift + R** on the keyboard or right-click on the item and choose **Rename**.

3. Enter the new name of the item and press **Enter**.

Deleting clips and sequences

You can delete unused clips or sequences you no longer need. However, you cannot delete files if they are being used in any existing sequences or subclips.

1. Select the clip or sequence you want to remove. Hold down the **Ctrl** key to select multiple items.
2. Press **Delete** on the keyboard.

A dialog box prompts you to confirm the deletion.

3. Click **Yes** to delete the file.

Changing master clip properties

You can change the video aspect of a master clip, add a description and keywords, and view file information.

1. Highlight the clip in the Bin, right-click and select **Properties**.

The Master Clip Properties window appears.

2. Add a description for the clip, or add keywords that can be used to search for this file.
3. Select the video aspect for the clip: **4:3** or **16:9**.
4. Click **OK**.

SmartBins

SmartBins provide a way to automatically synchronize media access between Aurora Edit and media server bins. A SmartBin monitors a folder on a media server and automatically updates the SmartBin contents when new or updated media appears.

SmartBins require a license from Grass Valley.

Understanding SmartBins

Using Aurora Edit in shared mode, you can automatically update clips, map folders, or automatically import files from a Media Server to one of your bins, known as SmartBins.

Aurora Edit monitors the server folder specified and automatically updates the SmartBin when new clips or updated feeds appear. You don't need to go into the server directory and copy the media into your Aurora Edit bin in order to use it for editing.

Related Links

[Creating a new bin](#) on page 50

[Creating a Shared SmartBin](#) on page 59

[Creating a Transfer SmartBin](#) on page 58

Creating a Transfer SmartBin

The Transfer SmartBin sets up automatic clip transferring from a Media Server to an Aurora Edit Bin.

1. Click the  **New Bin** icon on the Bin toolbar.
2. In the SmartBin Type drop-down list, select **Transfer SmartBin**.
3. Click **Browse** to the right of the Server Path field.

The Select Server Bin window appears.

4. If you are using a Network Attached Storage (NAS) server, enter the name of the server and click **Connect**.

You only need to enter the name of the server the first time you connect; the server connects automatically once you've set it up.

5. Select the bin to monitor and click **OK**.

The Server Path fills in with the selected Bin and the Enable SmartBin checkbox gets checked.

6. Click **OK** to create the SmartBin.

Aurora Edit now monitors the Media Server folder and automatically adds new media to this bin.

Related Links

[Understanding SmartBins](#) on page 58

Creating a Shared SmartBin

Shared SmartBins set up a link for an Aurora Edit bin to monitor a folder on the media server.

Media is not moved between the server and bin; instead, media is mapped into the two directory structures — a process known as "mirroring".

1. Click the  **New Bin** icon on the Bin toolbar.
2. In the SmartBin Type drop-down list, select **Shared SmartBin**.
3. Click **Browse** to the right of the Server Path field.

The Select Server Bin window appears.

4. Select the bin to map with and click **OK**.
5. Click **OK** to create the SmartBin.

Once the mapping association is made, the SmartBin Service automatically keeps the bins synchronized.

Related Links

[Understanding SmartBins](#) on page 58

Chapter **3**

Using MediaFrame to manage media

This section contains the following topics:

- *Understanding MediaFrame*
- *Searching for media*
- *Using Explore to bookmark locations*
- *Using Collections to categorize clips*
- *Using metadata to define clips*

Understanding MediaFrame

MediaFrame is an Aurora Edit plug-in that provides a variety of tools for organizing, managing, and searching media clips.

The MediaFrame plug-in allows Aurora Edit to incorporate some key Aurora Browse asset management functionality within the editor itself. This includes enhanced search capabilities within the bin, scene detection for sources, links to lo-res assets, offline assets, and metadata entry even in environments that do not have lo-res media.

MediaFrame is configured from **Tools | Options | General**. It includes a field for the MediaFrame server name or IP, and a checkbox to enable or disable MediaFrame functionality without clearing the field.

Aurora Edit consumes a Browse license when MediaFrame is enabled, so the number of available licenses must be considered when configuring the system.

Once configured, the application presents a number of different touch points in the MediaFrame plug-in architecture:

- **Bin**—MediaFrame adds the Search, Explore, and Collections tools to the bin.
- **Clip Source**—MediaFrame provides access to the general, custom, and keyword/keyframe metadata fields from the clip source as well as the Record to Bin and Trim Tools.

Metadata entry is permissioned through MediaFrame/Aurora Browse roles and responsibilities.

- **Timeline Storyboard**—MediaFrame can display a storyboard in the Timeline area to show either scene detection thumbnails or keyword/keyframe thumbnails.
- **Sequence Metadata**—Sequences are not added to the MediaFrame database until they are linked to placeholders during "Published" sends. Once sent to a publish location, the sequence appears as a searchable asset in the MediaFrame database. In addition, the sequence properties of the published story has a metadata tab for entering additional information.

Note that effects, graphics, Bins, and audio-only files cannot be seen in the MediaFrame database.

Searching for media

Setting search criteria

With Aurora Edit and MediaFrame, you can specify various criteria on which to search for media.

1. In the Bin toolbar, click the  **Search** icon.

2. Enter search criteria in one of these two fields:
 - All or part of the asset name
 - A word or phrase in the asset metadata
3. Select how many results to view by clicking the **Limit results to** drop-down box and choosing 50, 100 or 500 assets.
4. Click **Search**.
Search results display in the lower pane of the Bin.

Tips for using search criteria

You can use a variety of methods to define your media search.

To search...	Follow these steps...
For logical assets	In the Asset Navigator view, under Advanced settings, select the Search in drop-down field. Specify the MediaFrame database and press the Search button. MediaFrame database searches return logical assets that contain metadata and links to any physical assets including high-resolution media and proxy video.
For physical assets	In the Asset Navigator view, under Advanced settings, select the Search in drop-down field. Specify the MDI device and press the Search button. MDI device searches return physical assets. If a red X is displayed against the MDI, the system is communicating with the MDI but the MDI is experiencing a problem. A red dot indicates there is no communication with the MDI, and a green dot indicates the server is communicating with the MDI.
Using specific criteria, such as searching for files created before a certain date	<p>Create a filter and use it to search: In the Asset Navigator view, click the down arrow next to Advanced Settings. The Advanced Settings dialog box displays. Click the Add Filter icon and select the Property and Comparison criteria from the drop-down lists. Click OK to add the newly created filter to the active filter list. Press the Search button.</p> <p>Notes: You can create an unlimited number of filters and save them as part of a search. You can use filters as independent search criteria or use them together with a text search. If more than one filter is defined, an AND operator is implied between them.</p>
Using only specific metadata fields	Under Advanced Settings, select the MediaFrame database or an MDI device. In the Fields drop-down

To search...	Follow these steps...
	list, check the field or fields to search on and press the Search button.
Using text or numbers in the name of the asset	Enter the search criteria in the Asset Name text field and press the Search button. Notes: Do not use wildcards or quotation marks in the Asset Name text field. Do not enter more than one word unless you are searching for an exact match of the multiple words and spaces.
Using text or numbers in the asset metadata fields of the asset	Enter the search criteria in the Asset Metadata text field and press the Search button. Notes: You can use wildcards or quotation marks in the Asset Metadata text field. If you enter more than one word or phrase, the OR operator is implied unless you specify otherwise. If you are searched for numbers in a number field, create a filter.
By asset name	Do not enter more than one word in the Asset Name text field unless you want to find both words exactly as typed with spaces. NOTE: The Asset Name field does not recognize quotation marks. To search for an asset by name, enter text or numbers in the Asset Name text field and click the Search button. Results are returned from assets that contain the search term in the name of the asset, even if it is a fragment of the name.
For an exact phrase	How you search for an exact phrase depends on whether you're entering the search term in the Asset Name or the Asset Metadata text field. NOTE: The Asset Name field does not recognize quotation marks. If you search within the Asset Metadata text field, enter the phrase in quotation marks. If you search within the Asset Name text field, enter the exact phrase.



To search...	Follow these steps...
With wildcards	<p>Wildcard searches can be performed in the Asset Metadata field. You can only use an asterisk at the end of a term, not in the beginning or middle.</p> <p>If you want to search using a beginning fragment of a term, use the wildcard asterisk symbol (*) in the Asset Metadata text field.</p> <p>Using an asterisk after a term returns any asset that contains the term, followed by a space or by more text, in any of the text fields.</p> <p>NOTE: <i>To search using a fragment that is found in the middle or the end of a word in the asset metadata, add a filter under Advanced Settings instead of using the Asset Name or Asset Metadata text field.</i></p>
Metadata fields	<p>You can limit your search to specific metadata fields or keywords, such as the asset name, the source ID or a keyword, by using the asset metadata text field and specifying the fields to search.</p> <p>Assets are returned if they have the word or phrase in any of the specified metadata fields.</p> <p>To search foreign metadata or keywords, you need to select these fields in the Filters drop-down list. <i>For more information, refer to the Aurora Browse Installation and Configuration Guide.</i></p>
With Boolean operators	<p>You can search with the following Boolean operators: AND, OR, and AND NOT. If you enter more than one term without a specific Boolean operator, the OR operator is implied.</p> <p>To search with Boolean operators, use the Asset Metadata text field.</p>
For numbers	<p>You can search for numbers in three ways:</p> <ul style="list-style-type: none"> • To find a number in the asset's name, use the Asset Name text field. • To find a number in the asset's text field metadata, such as the description, use the Asset Metadata text field. • To find a number only in a specific category, such as a number metadata field or a specific Creation Date, Modification Date, etc., create a filter and select the property to search on. <p>NOTE: <i>You cannot search for single numbers in the Asset Metadata text field. Any single character, letter</i></p>

To search...	Follow these steps...
	<i>or number, is treated like a "noise" word and is ignored. To search for a single number in the metadata, create a filter.</i>
With noise words	<p>Certain "noise" words or characters are automatically ignored in a search in the Asset Metadata text field.</p> <p>Examples include:</p> <ul style="list-style-type: none">• Prepositions or articles (such as "after", "before", "the", "an", etc.)• Single characters or numbers ("a", "z", "0", "9", "\$", "_", etc.)• Pronouns ("who", "him", "mine", etc.) <p>Common verbs (such as "will", "said", "want", etc.)</p> <p>To search for noise words, create a filter containing the word or words you want to search for.</p> <p>If you have administrator privileges, you can modify the SQL file containing the noise words. Modifying this list might affect expected execution times.</p>

Saving a search

You can create a customized search that searches specifically for particular text or properties.







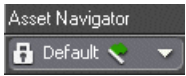

Searches can be saved globally for universal access, or locally for your access only. Global changes are saved to the server when you close the Aurora Edit application. Other users need to reopen Aurora Edit before they can see the changes.

1. In the Bin, click the  **Search** icon.
2. Enter your search criteria.
3. Click the  **Add Saved Search** icon.
4. Name the search, and if desired make the search accessible globally.

You cannot give a search the same name as one of the default searches (indicated by a lock icon).

Working with searches

With Aurora Edit and MediaFrame, you can specify how searches are organized and saved.

Icon	Description
	Displays the name of the current search, if any.
	Saves search criteria, either globally or locally.
	Deletes the current search.
	Sets the current search to be the default search.
	Resets the default search.
	Undoes the default search reset.
	Indicates a search saved on the MediaFrame server by a particular user. Can be accessed by the user from any Browse Client where they're logged in.
	Indicates a search saved globally.
	Indicates a default search (installed with the application, cannot be modified).

Using filters to refine a search

About searching with filters

Using a filter, you can search assets by name, description, or other specific criteria. You can also use a filter if you are searching for a fragment of metadata.

You can also use a filter in conjunction with text in the asset name or asset metadata text fields. If you search using a text field and a filter, only assets that have the search term and meet the specified criteria are returned.

You can create an unlimited number of filters and save them as part of a search. Filters can be used as independent search criteria or together with a text search that uses Boolean operators, fragments of asset names, or other asset metadata. Creating a keyword-based filter or an association-based filter lets you find logical assets that are associated with specific criteria.

If more than one filter is defined, an AND operator is implied between them.

When you create a filter, you can add it to your list of favorite filters. This allows you to quickly access the filters.

The favorite filters are only accessible on the PC where they were created, but they are available regardless of which search you are using. You can access the list by clicking on the Favorite Filters icon. 

Related Links

[Searching for Offline Assets](#) on page 174

Creating a filter

Filters let you customize your searches so that you can quickly locate specific assets.

1. In the Search window of the Bin, click the double arrow or the plus sign next to **Advanced Settings**.

(Which button is displayed is determined by the length of the Search pane.)

The **Advanced Settings** dialog box displays.

2. Click the **Add Filter** icon .

The Add Filter dialog box displays.

3. Select the Property and Comparison criteria from the drop-down lists.
4. If you want to use this filter frequently, check the Add to Favorites box.

If you want to delete the filter from the Favorites list later, you can select **Modify Favorites**.

5. Click **OK** to add the newly created filter to the active filter list.

The new filter is displayed in the Filters field.

When you want to use this filter to search for media, click the **Search** button.

Working with filters

If you need to, you can modify the characteristics of a filter or delete one you no longer use.

- To modify a filter:
 - a) Select the filter and click  **Modify Filter**

The Edit Filter window opens.

- b) Make any changes to the filter characteristics.
- c) Click **OK**.

You can also double-click on a listed filter to open the Edit Filter window.

- To remove a filter, select it and click  **Delete**.

Using Explore to bookmark locations

The Explore tool allows you to browse your network and save network locations (servers and folders) as Favorites just as you would in the Windows Explorer. Favorites serve as one-click shortcuts to the locations you use most, and also as destinations onto which you can drag assets to transfer them across the network.

To do this task...	Follow these steps...
Browse the network	<ol style="list-style-type: none"> 1. Navigate the network from the All Locations pane. 2. Select a location from the All Locations pane to view its contents in the Explore pane.
Add a favorite location	<ol style="list-style-type: none"> 1. Browse the network in the All Locations pane. 2. Right-click on a server or folder and select <ul style="list-style-type: none"> • Add to Favorites -- Adds the location to Favorite Locations Personal Favorites • Add to Global Favorites -- Adds the location to Favorite Locations Global Favorites <p>You can drag Favorites to reorder them, or right-click a Favorite and select Move Up or Move Down.</p>
Go to a favorite location	Click on a Personal or Global Favorite in the Favorite Locations pane.
Copy an asset	<ol style="list-style-type: none"> 1. Right-click on an asset in the Explore pane and select Copy. 2. Right-click on a Favorite and select Paste.
Transfer (move) an asset	<ol style="list-style-type: none"> 1. Drag an asset (clip or folder) from the Explore pane onto a Favorite. <p>The Transfer Options window appears.</p> 2. Select Automatically rename destination "K2 Movie" ... to rename the asset if an asset with that name exists at the destination. 3. Select Save settings for similar transfers to have subsequent clips being transferred keep these settings.

Using Collections to categorize clips

About Collections

Collections provide a way to sort and organize assets within a bin for easy access.

You can create collections for yourself or for all users to share, and save them for future use or only until you close the Aurora application.

Name	Description
Private	Saves a collection that only you can access
Shared	Saves a collection that all users may access
Temporary	Creates a temporary collection that is deleted when you exit the application
Logical	Links to asset content (raw video, sound, images), metadata, and proxy assets (low-res footage)
Physical	Links to asset content (raw video, sound, images) only

Creating a collection

You can create collections to sort and organize clips within the Bin for easy access

1. Click the **New Collection** button.
The New Collection window appears.
2. Enter a **Collection Name**.
3. Select a **Collection Type**:
 - Private - Saves a collection that only you can access
 - Shared - Saves a collection that all users may access
 - Temporary - Creates a collection until you close the Aurora Edit application, then it is deleted
4. Select the **Content** type:
 - Logical - The collection references clip content (raw video, audio, sound, images), metadata, and proxy assets (low-res footage)
 - Physical - The collection references clip content (raw video, audio, sound, images) only
5. Click **OK**.

Modifying Collections

Once a collection is created, you can modify the name of the collection, as well as change the Content type, or delete a collection.

To do this task...	Follow these steps...
Delete a collection	Select the collection and click Delete Collection
Rename a collection	Select the collection, click on the name, and type a new name
Toggle a collection between private and shared	Right-click on the collection and [de]select Shared With Others
Save a collection	Right-click on the collection and select Saved for Future Sessions
Perform a batch operation on all the assets in a collection (e.g. copy all the assets)	Right-click on the collection, select Act on Contents , and choose the desired action.

Viewing Collection contents

1. Select a collection from the top part of the bin.
Its contents are displayed in the bottom part of the bin.
2. Click **Refresh Collection** to refresh the collection content display.

Adding assets to a collection

You can only add assets of the same content type as the collection group.

1. Select the asset(s) you want to add to a collection.
2. Choose one of these methods to add assets:
 - Right-click on the asset and select **Add to Collection | collection_name**.
 - If you need to create a new collection, right-click on the asset and select **Add to Collection | New Collection**, and add the collection properties in the New Collection window.

To remove an asset from a collection, select the asset from the collection contents and press **Delete**.

Using metadata to define clips

About metadata

Metadata is data about data; it can include keywords, timecode information, and other terms that help you find a particular asset.

Metadata adds descriptive information about media assets. An administrator can create customized, predefined metadata fields to speed selection and avoid errors. You can enter information in custom metadata fields before, during, or after assets are ingested. You can also print metadata.



Once metadata has been entered into the Aurora system, it is searchable and you can use it to locate the specific assets recorded at that time.

The types of metadata featured in Aurora Browse are described in the following table.

Type of metadata	Description
Core	Certain metadata brought in through Aurora Ingest, such as Name, Creation Date, Description Field and Keywords appear in Browse with high-resolution associations. Likewise certain metadata added in Aurora Edit as part of Master Clips and Sequences also get added to Browse environment for a common metadata view. An administrator can customize and expand mapping depending on your workflow requirements.
Custom	Metadata in fields that have been created by an administrator. Custom metadata can include text fields, as well as date, number, or Boolean fields.
Logical asset	Metadata about a logical asset, that is, metadata about the MediaFrame database information, physical asset or assets on the server, and proxy assets.
Physical asset	Metadata about a physical asset, or essence, is metadata about raw program material, such as video or audio.





Related Links

Adding general information

1. Select the Source Tool by pressing **2** on the keyboard or clicking the  **Source Tool** button.
2. Click the  **View Metadata** button.

The metadata tabs open in the dynamic tool area.





3. Enter information about the clip:

Field or Button	Description
Thumbnail	The still image of the frame that the general metadata describes. To change the thumbnail, right click on the image.
Name	The asset name. If the asset has been located using Search, the name is highlighted.
Source	The name of the advanced encoder that encoded the proxy.
Expires Hold Duration	Enter an expiration date If the date field is not defined, click the drop-down arrow to bring up a calendar and select a date. If a date has already been entered, you can modify it by typing a new date in the Expires field. Check the hold box if you don't want the asset to expire. The asset cannot be deleted until the hold box is unchecked. The duration indicates the length of the asset.
Description	Click in the Description text field to enter text, if desired. If you press Enter after adding a description, you will see [] symbols immediately after the word in the Description column of the Asset list.
Search Terms	Additional search information.
	Refresh the metadata.
	Print the general metadata.
	Undo the metadata change.
	Redo the metadata change.

Using keywords to define clips

Adding keywords

Keywords reference a specific timecode location in the media file; they provide a powerful way to find specific assets. You can create subclips based on keywords.

1. Create an In point by playing the footage and clicking  Mark In at the starting point for the keyword.
2. Create an Out point by clicking  Mark Out at the end point for the keyword.
3. If you are not in the Source Tool, press **2** on the keyboard or click  **Source Tool**.
4. Click the  **View Metadata** button.
5. To **Add Keyword**, select **F3** or the **Keywords** tab.
6. Click the Keyword drop-down list and select  **Add Keyword**.



The new keyword displays.

7. To change the name of the keyword, double-click on the default keyword name, enter the new name, and click off of the keyword.

The keyword is added to the list.

Adding auto-mark keywords

You can define how newly created keywords or keyframes are named using the Keyword Options dialog box.

1. Select the Source Tool by pressing **2** on the keyboard or clicking the  **Source Tool** button.
2. Click the  **View Metadata** button.

The metadata tabs open in the dynamic tool area.

3. Click the **Keyword Options** icon, next to the Mark In and Mark Out fields.

The Keyword Options dialog box displays.

4. To automatically generate keyword names, check the Auto-Generate keyword names box and fill in the text field.

Once the option is checked, keywords are created using the defined naming rule. (Optionally, you can use "%" to specify where the numbering will be placed.)

If the option is not checked, the default keyword name, keyword , is used with an incremental suffix.

5. Click **OK**.

Deleting keywords

You can delete keywords you no longer wish to use.

Deleting the material between the Mark In and Mark Out points does not delete the keyword. Instead, it moves the keyword's Mark points to the asset's original timecodes.

Adding keyframes

A keyframe is a zero-length keyword.











Rather than being created from the currently selected mark-in and mark-out points, a keyframe is created at the clip player's current play position. Selecting a keyframe moves the clip player's current position to that location, but it doesn't modify the mark-in or mark-out points.

- Use one of these methods to create a keyframe:
 - Press the **Insert** key on the keyboard.
 - On the Keywords tab, click on the arrow next to the Add Keyword button and select  **Add Keyframe**.

The keyframe displays as a notch, similar to a storyboard marker.



Working with keywords

In the Keyword tab of the metadata area, you can add keywords or keyframes and manage your keywords.

Field or Button	Description
	Add a keyword
	Add a keyframe
	Auto-mark keywords
	Reassign keyword marks
	Create a subclip for the selected keyword footage
	Delete selected keyword(s)
	Refresh the keywords in the list
	Print the clip metadata
	Undo the last metadata change
	Redo the last metadata change

Managing custom metadata fields

If you have MediaManager privileges, you can add, edit, or delete custom metadata fields.

1. Select the Source Tool by pressing **2** on the keyboard or clicking the  **Source Tool** button.
2. Click the  **View Metadata** button.
3. In the Custom tab, click the **Manage Fields**  icon.

The Edit Custom Metadata Fields dialog box displays.
4. Click **Add** in the Fields list.

The Add Custom Metadata field displays.
5. Enter the Name of the new field.

The name displays in the Custom tab of the metadata section of the Source Tool.
6. Select the Type of field you want to add.



Field types can be text that a user fills in or a list of options.
7. Click **OK**.

The new field is added to the Field list.
8. Click **Close** to exit out of the window.

Using custom metadata fields

Custom fields allow you to enter additional asset metadata such as names, air dates, or source locations.

An administrator can create custom metadata fields.

1. Select the Source Tool by pressing **2** on the keyboard or clicking the  **Source Tool** button.
2. Click the  **View Metadata** button.
3. Click the **Custom** tab.
4. Add values to the custom fields by one of the following methods:
 - Select a choice from a drop-down list
 - Type the data into the field
 - If the custom field is a date field, click in the date area and then pick the correct date on the calendar

The field data is associated with the asset.

Printing metadata

You can print the metadata for a clip from all three metadata tabs: General, Keywords, or Custom.

- Click  **Print** from any of the metadata tabs.

Acquiring media

This section contains the following topics:

- *Using clips stored in the Bin*
- *Using a clip source*
- *Recording to the Bin*
- *Using files from removable media*
- *Importing files*
- *Batch recording*

Using clips stored in the Bin

If you have clips in the Bin before starting a sequence, you can bring them onto the Timeline and use them in a new sequence.

You can be in any of the Aurora Edit tools to load clips from the Bin onto the Timeline.

1. Navigate through the Bin until you find the clip you want.
2. Double-click the clip to load it into the Timeline.

The clip loads into the clip source of the Timeline.

Using a clip source

You can load any clip from your Bin into the Source Tool, which effectively treats the clip like a live source such as a tape deck.

1. Drag the clip into the viewer or press **Shift + C** to load the clip.
2. Edit the footage to the Timeline as you would a tape deck.

Related Links

[Editing in the Timeline](#)

Recording to the Bin

You can record media directly to the Bin to use later.

Once you open a bin, you can record from your tape deck or any other source directly into that bin. You later edit that material in the Bin or bring it into the Timeline.

1. Open the bin where you want the media to reside.
2. Click the  **Record to Bin** button in the menu bar.

The Record to Bin window appears.

3. Enter the name of the clip and add a description (optional).

You can also use Tape ID as a way to identify where your source video originated.

4. Choose the record source using the drop-down menu.
5. Play or cue the tape to the place where you want to start recording.
6. Mark an In point by pressing **I** on the keyboard.

If you don't set a Mark In, Aurora Edit uses the current position. Optionally, scrub the video and mark an Out point here.

7. Press **F12** to start recording; the recording appears in the Record Window.

8. When you are done recording, press the **space bar** to stop, or press **O** on the keyboard to stop recording after adding Out handles.

If you marked an Out point, recording stops at that point. Aurora Edit automatically saves the clip into the selected bin.

9. Close this window by clicking the **X** in the upper right corner.

Related Links

[Naming source tapes](#) on page 98

Using files from removable media

Aurora Edit can import and use files from three types of removable media—Panasonic P2 cards, Sony XDCam Professional Disks (SD,HD, and EX), and REV[®] Pro USB drive disks.

When previewing media, HD XDCam files always use the low-resolution proxy. With SD files, you have the option of using proxies or high-resolution media.

Aurora Edit supports shot status for P2 and XDCam. In addition, if a unique title was given to a clip in P2 or XDCam, Aurora Edit will recognize that title and display the modified name.

JVC also has the ability to encode in the XDCAM EX format. These files import correctly with both Aurora Edit and RMI.

1. Make sure you have the appropriate removable media driver(s) installed on your Aurora Edit machine.

The drivers are located on the Aurora Suite CD-ROM.

2. Insert the removable media into the drive.
3. In Aurora Edit, select **View | Removable Media Bin**.

The Bin opens and operates the same as the Aurora Edit Bin.

4. If you want to pre-cache proxies for quicker preview, click  **Cache All Proxies**.

Otherwise, proxy files are cached when the file is opened. Once cached, status is updated, represented by a yellow triangle in Thumbnail View or listed in the status column in Details View.

NOTE: *While proxies are being cached, you cannot playback video. You can, however, continue to edit high-resolution media that is already stored on your system.*

5. Import the files into Aurora Edit using one of the following methods:
 - Double-click on a file to open it in the Trimmer, mark In and Out points to select the footage you want, and either create a subclip or copy to the Timeline.

- Drag the clip into the viewing window of the Timeline or Source Tools; footage becomes a clip source and can be used to mark clips.
- Drag a clip (or a selection of clips) into the Aurora Edit Bin.
- To view all clips on the removable media as one long file, click  **View as Tape** in the Removable Bin toolbar, scrub the file as needed, then import.

NOTE: *View as Tape is not available for REV Pro media.*

The contents of the Bin won't refresh automatically if you change a card or disk; press F5 to refresh the Removable Media bin.

Proxies are stored in the same location as the default VibrantAVFiles folder and are not removed automatically; you should delete these files periodically.

Importing files

Importing clips

You can import media clips from your computer network or other Aurora Edit workstations. Imported clips appear in your Bin so you can use it in sequences.

1. Click in the Bin window. then choose **File | Import | Clip**.

The Import Clips window appears.

2. Use the **Look in** list or **Browse** button to find the clip you want to import.
3. Highlight the clip and click **Import**. Press the **Ctrl** key to select multiple clips.

A progress bar indicates the import status.

The imported file appears in the Bin; you can use it just like any other clip.

Importing EDL files

You can import common EDL formats (.OMF or .XML) from low-resolution editing systems or .AAF files created from Aurora Edit high-resolution media. These files contain sequenced clips that you can use to create your own sequences.

1. Click in the Bin window, then choose **File | Import EDL**.
2. Navigate to the EDL file you want to import and select it.
3. Click **Open**.

A progress bar indicates the import status.

Aurora Edit creates a new bin with the name of the imported EDL for the sequence and its clips.

Related Links

[Exporting EDLs](#) on page 245

[Enhancing audio using OMF files](#) on page 159

Importing effects

You can import video effects from other workstations as well as saved effects you created for other sequences.

1. Click in the Bin window, then choose **File | Import | Effect**.

The Import Effect window appears.

2. Navigate to the effect you want to import, select it and click **Open**.

A progress bar indicates the import status.

The effect appears in the Bin; you can bring it into the FX track on the Timeline.

Related Links

[Using saved effects in your sequence](#) on page 192

Importing graphic files

You can import 24- or 32-bit graphic files in Aurora Edit and Aurora Edit LD, which you can use in the graphics track of your sequence.

You can also superimpose a bitmap (with an alpha key) over the video in your clip. Imported graphics appear in your Bin.

1. Choose **File | Import | Graphic**.

The Import Graphics window appears.

2. Navigate to the graphic you want to import and select it.
3. Resize the image, if necessary, by checking the **Size to Fit** or **Center** boxes.

It is recommended that the **Auto Detect Sequential Files** checkbox be left unchecked unless you are working with sequential TGA files. Leaving the checkbox checked prevents the importation of more than one graphic at a time.

4. Click **Open**.

A progress bar indicates the import status.

The imported graphic appears in the Bin; you can bring it onto the Timeline on the Graphics (G) track.

You can also import a graphic directly to the Timeline by choosing **File | Import | Graphic** while the Timeline window is currently selected.

NOTE: *For Aurora LD, this is the same functionality as the high-resolution Aurora Edit, but Aurora Edit LD must import the file into a directory that it has access to. If it is not attached to the hi-res volume (V), then it must import to a directory that it has access to.*

Animated sequential .tga files are not supported for Aurora Edit LD; only still graphics may be imported via this application.

Graphic file formats

Aurora Edit supports these graphic file types:

Type of File	File Extension
Windows Bitmap	.bmp
Truevision Targa	.tga
JPEG - JFIF Compliant	.jpg, .jpeg
Tagged Image File Format	.tif, .tiff
Portable Network Graphic (PNG)	.png
Photoshop	.psd
Macintosh PICT	.pct
Zsoft Paintbrush	.pcx
Graphics Interchange Format	.gif

Related Links

[Importing a TGA animation sequence](#) on page 86

Importing media

You can import media in a variety of formats into your sequence.

1. Click in the Bin window, then choose **File | Import | Media**.

The Import Media window appears.

2. Navigate to the media you want to import and select it.
3. Select the Format and Compression Type, if needed.
4. If you are importing AVI, MPG, or WM9 Files, click **Options** and adjust these settings, if desired:

Setting	Options	Description
Bit Rate (Mbps)		Automatically set according to the
Chroma Format		Compression type.
Video Resolution		
Aspect Ratio	4:3	Select the correct aspect ratio for your
	16:9	media:
		4:3 for Standard Definition (SD)

Setting	Options	Description
		16:9 for High Definition (HD).
Aspect Ratio Option	Pillar Box Half Pillar Box Zoom Stretch	Select which ratio option is appropriate.
Tracks	Video and Audio Audio Only Video Only	Select which tracks you want to import into your sequence.
Field Order	Top First Bottom First	Select the Field Order for the selected files.

5. Click **Open**.

A progress bar indicates the import status.

The imported media appears in the Bin as a Master Clip; you can bring it onto the Timeline to use in your sequence.

You can also export graphics to enhance or tweak it and then import the enhanced file back into your sequence.

Related Links

[Creating a playback list](#) on page 241

Imported media formats

Aurora Edit supports these media types for importing:

Type of File	File Extension
AVI Files	.avi
MPG Files	.mpg, .mpeg, .mpe, .m1r, .m2v
WM9 Files	.asf, .wmv
MOV Files	.mov
MPEG-AVI Files	.avi
CD Audio Files	.cda
MP3 Files	.mp3, .mp2
WAV Audio Files	.wav

Type of File	File Extension
AIF Audio Files	.aiff, .aifc, .aif
WM Audio Files	.wma
AU Audio Files	.au
GXF Files	.gxf
MXF Files	.mxf

Importing a TGA animation sequence

You can import .TGA animation sequences to use in your Aurora Edit sequences. Aurora Edit imports a TGA bitmap file for each frame of sequentially numbered video, and combines them into a single video clip.

In order to use a .TGA sequence in Aurora Edit, the Aurora Edit sequence needs to have a Graphics track available.

The imported animation sequence, when placed on the Aurora Edit Timeline, is a video clip plus a resize video effect using the alpha channel for transparency.

If, for some reason, you don't want the animation sequence to be transparent over the video on the other video track, you can turn it off by highlighting the clip, right-clicking and selecting **Properties**, and unchecking **Enable Video Alpha**.

1. Click in the Bin window, then choose **File | Import | Graphic**.

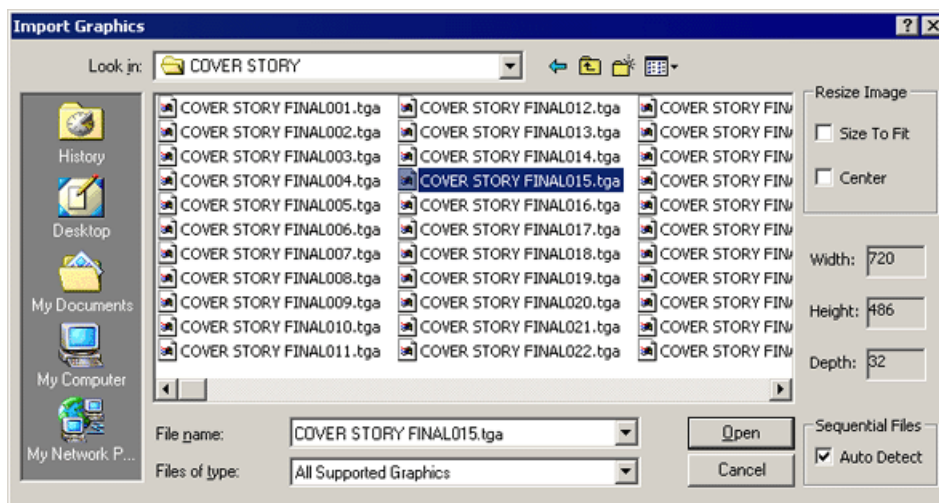

The Import Graphics window appears.

2. Navigate to the animated sequence you want to import.
3. Leave the **Resize Image** checkboxes unchecked; these fields don't apply when importing an animated sequence.

4. Check **Auto Detect Sequential Files** to import all sequentially numbered .tga files with the same filename.
5. Select one file that is part of the .TGA sequence.
6. Click **Open**.

A progress bar indicates the import status. The imported file(s) appear in the Bin as a single video clip.

7. To add the animation clip to the Graphics track in your Aurora Edit sequence, make sure your sequence has an active Graphics track.
8. Drag (or copy) the animation clip onto the Timeline Graphics track.

The clip appears on the Graphics track.

NOTE: *TGA animations that were imported prior to version 7.X will need to be imported again as they were previously imported to the V2 and Effects tracks.*

Related Links

[Graphic file formats](#) on page 84

[Understanding keyframes](#) on page 196

Importing a MOV Animation File

You can import animation .MOV files to use in your Aurora Edit sequences. If the .MOV file is an animation with alpha, it is recognized as such and imported as an animated graphic into a selected bin.

1. To import an animation MOV file, click in the Bin window, then choose **File | Import | Media**.

This will bring up the **Import Media** window.

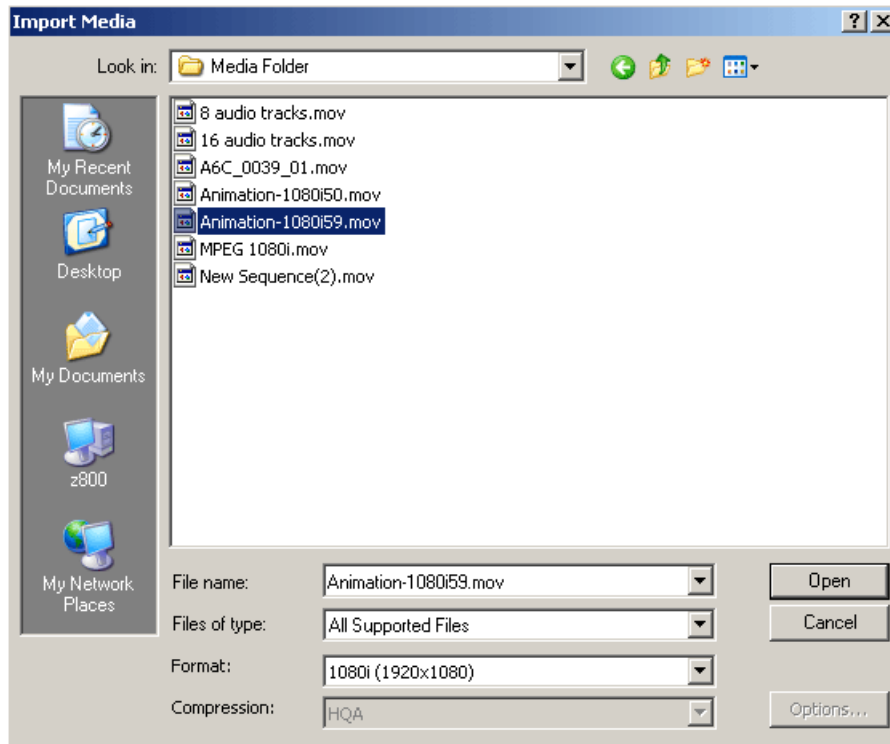

2. Navigate to the animation file you want to import and highlight it.
3. Click **Open** to import the movie file to the bin specified.

Batch recording

About batch recording

You can record multiple clips at a time using Batch Capture, which you access from the Record to Bin window.

Batch Capture lets you mark clips from a Source tape and add them to a Batch Capture list. You can also use footage from multiple Source tapes in the same Batch Capture list. Once you create your list, you can record the clips to the Bin.

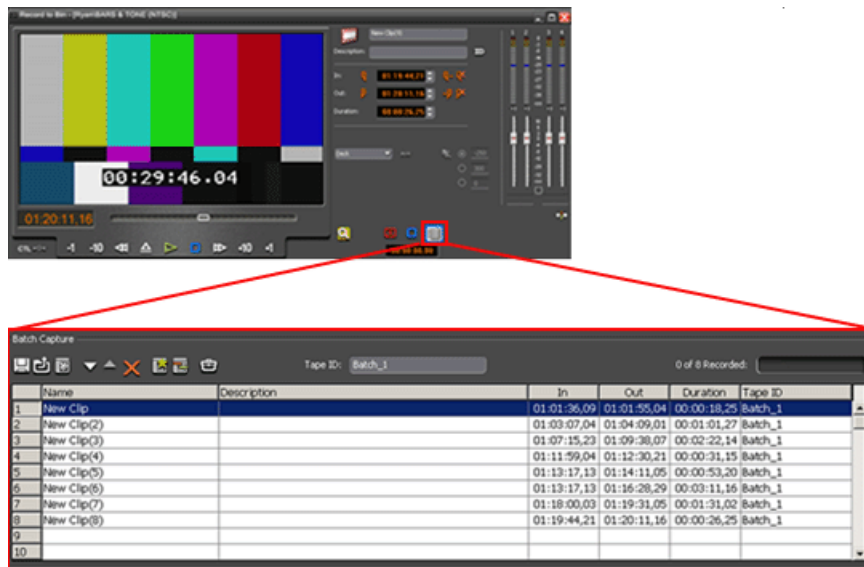

Creating a Batch Capture list



You need to create a Batch Capture list before you can record clips to the Bin.

1. Insert a tape into the VTR.
2. Open the bin where you want the media to reside.
3. Click the  **Record to Bin** button in the menu bar.

The Record to Bin window appears.

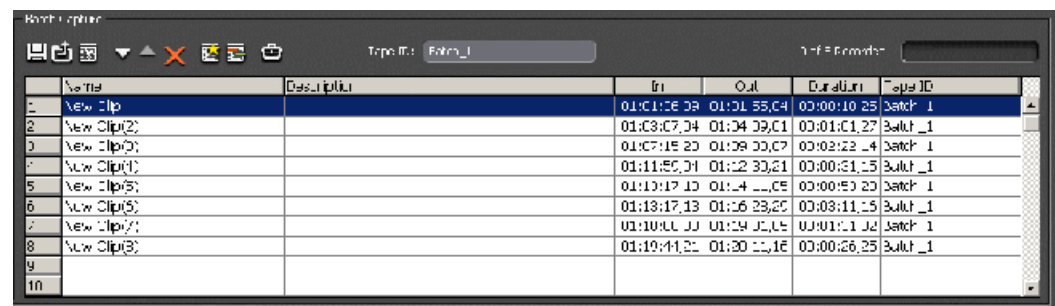
4. Click the  **Batch Capture** button; the Batch Capture window expands as part of the Record to Bin window:



5. Type a name for the first tape you are getting footage from in the Tape ID box.
6. Click  **Play** in the Record to Bin window to begin playing the tape.
7. Use the transport controls to locate the material you want to record.
8. Create a Mark In and Mark Out point for the clip.
9. Click  **Add from deck presets** or press **C** to add the clip to the Batch Capture list.

10. Repeat steps 7-9 to create additional clips.
11. To use additional tapes, insert a new tape into the VTR and repeat the steps above.







Aurora Edit asks you for the new tape name when you add the first clip to the Batch Capture list.

When you are done creating your Batch Capture list, you can save it or record the clips to the Bin.

Rearranging the Batch Capture list

Once you have clips in the Batch Capture list, you can rearrange them if you need to.

- Use the following buttons to rearrange your list:

Button	Function
	Clears the Batch Capture list.
	Moves the selected clip down in the list.
	Moves the selected clip up in the list.
	Deletes the selected clip.
	Adds the selected clip to the batch capture list.
	Replaces the selected clip with the new Settings. Click Replace with current deck presets instead of Add from deck presets after marking a new clip.

Changing row colors in the Batch Capture list

You can change the way Aurora Edit displays rows in the Batch Capture List.

1. In the Batch Capture list, click the  Settings button.

2. In the Settings window, click the Change button next to the row color you want to change.
3. Pick a new color and click **OK**.

To return all colors to their Aurora Edit default color, click **Use Defaults**.

4. Change other row colors as necessary.
5. Click **OK**.

Saving a Batch Capture list

Once you've created a list, you can save it and record it later.

1. Click the  **Save** button in the Batch Capture window.

The Save As window appears.

2. Navigate to the directory where you want to save the list.

To easily organize and keep track of files, you can create a separate folder to store all of the batch capture files.

3. Name the file and click **Save**.

The batch record list gets saved as a DNP Batch Log File with a .vlg extension.

Loading a Batch Capture list

You can load a previously saved Batch Capture list or a batch list created on another system.

Aurora Edit supports these types of batch lists:

- DNP Batch Log Files (.vlg)
- Avid Log Exchange (.ale)
- CMX EDL Files (.edl)
- CSV—Comman delimited files (.csv)

1. Click the  **Load** button in the Batch Capture window.
2. Locate the file containing the list and click **Open**.

The file loads into the Batch Capture and is ready to record.

Recording clips to the Bin

You record your batch capture list to the Bin.

In case of a failure during recording, a Batch Capture Log can be found in **C:\Program Files\Grass Valley\Aurora Edit\Logs**. This log files contains error events which describe the problem during capture.

1. Load the Batch Capture list into the window, if it isn't already open, or create a new one.
2. Press **F12** or click  **Record**.

Aurora Edit records the clips from the current tape in the VTR first or asks you to insert a specific tape.

Each of the clips records to the Bin. Row color changes to reflect the current status of each clip.

Once the clips are recorded, you can bring the clips into the Timeline to use in a sequence.

NOTE: When marking clips from a tape with discontinuous timecode, you can switch to CTL Track and add the clip to the list. Aurora Edit dynamically switches from Timecode to CTL Track depending on how the clips were originally marked.

Preparing to edit

This section contains the following topics:

- *Creating a new sequence*
- *Preserving ANC Data*
- *Selecting and deselecting tracks*
- *About editing modes*
- *Naming source tapes*
- *Routing audio tracks*
- *Using variable speed record*
- *Selecting your source*
- *Linking to an existing news or sports story*
- *Using the Assignment List Manager*

Creating a new sequence

Aurora Edit uses sequences to create your news story; video clips, audio, and effects are all part of your sequence.

The new sequence must be inside a bin in order for you to use it.

1. Click the  **New Sequence** button on the Bin contents toolbar.

The Sequence Properties window appears:

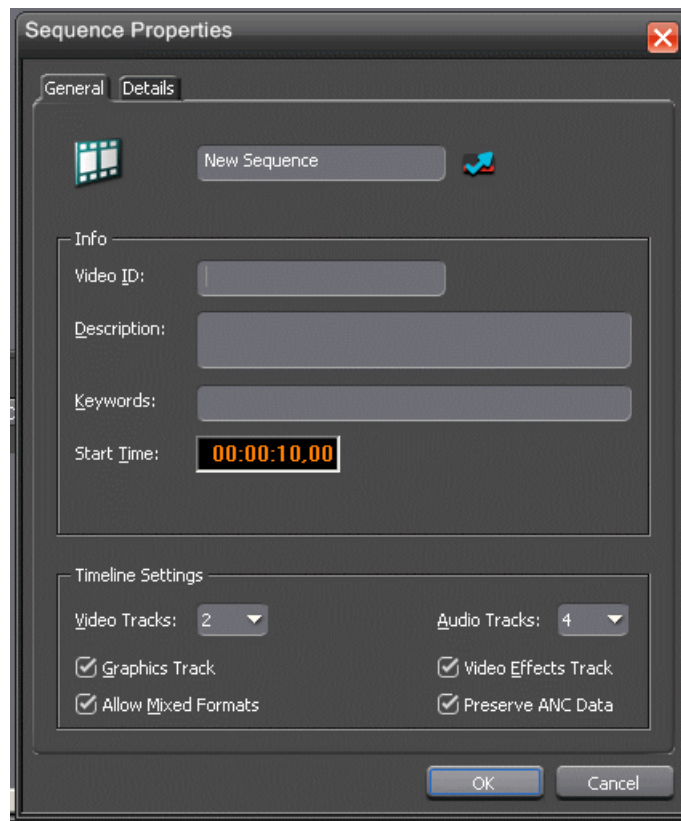

2. Enter a name for the sequence (or use the one Aurora Edit assigns).

Continue to the **Info** section of the window.

3. In the **Video ID** section,
4. Enter a **Description** and **Keywords** for the sequence (optional).

You can use keywords to search for a specific sequence in your bin.

5. To use a **Start Time** other than 00:00:00:00, enter another time.

The date of the sequence creation will be shown below the **Start Time**.

Continue to the **Timeline Settings** section.

6. Select the number of **Video Tracks** to use for this sequence from the pulldown (1 or 2 tracks).
7. Select the number of **Audio Tracks** to use for this sequence from the pulldown (2-16 tracks).

Audio Tracks refers to the number of tracks in the Timeline for mixing, not the number of output tracks.

8. Check the **Graphics Track** checkbox if you will be adding graphics to this sequence and the **Video Effects Track** checkbox if you will be adding video effects.
9. Check **Allow Mixed Formats** if you want to mix and match video formats in real time within the same Timeline.

This checkbox is active only when **Allow Mixed Format Timeline** is enabled in **Tools | Options | Timeline**. In addition, all clips that differ from the video format of the Timeline need to be transcoded when the completed sequence is sent to a destination.

10. ANC data is preserved on all feeds sent via a Smartbin (the option to preserve ANC data from a K2 or Summit storage device must be selected in the Audio/Video Configuration under Data Track Setup). Checking the **Preserve ANC Data** checkbox allows the edited sequence to preserve ANC data on send. The video can be previewed on external monitors to view captioning data via the SDI output of an AJA Breakout Box (BOB) . Note that this feature is not available with the older SD AJA Breakout Box only with the LHi version.

More detailed information on preserving ANC data is provided in this manual and the *Aurora Edit and Aurora Edit LD Installation Manual*.

11. Click **OK** to save the sequence.

The new sequence appears in your Bin and the Timeline opens.

You are now ready to add footage to the Timeline.

Related Links

[Preserving ANC Data](#) on page 96

[Preserving ANC Data](#) on page 96

Changing sequence properties

After creating a sequence, you can change any of the sequence properties as needed.

1. If the sequence is open in the Timeline, click the  **Properties** button in the Timeline toolbar. If you are in the Bin, right-click on a sequence and choose **Properties**.
2. Make any necessary changes.
3. Click **OK** to save your changes.

Preserving ANC Data

Sequences created in Aurora Edit have a **Preserve ANC Data** checkbox that when selected will allow ancillary data in clips sent to a Smartbin from a K2 or Summit storage device to be preserved on the Timeline. The closed captioning present in the ancillary data of a clip can be displayed on the SDI output of an optional AJA Breakout Box (BOB) (LHi version only).

When incoming feeds with closed captioned data are recorded to a K2 or Summit storage device, the K2 or Summit will put this data into an ancillary data track when the generate ancillary data option is turned on on the K2 or Summit device. This is done in Audio/Video configuration under Data Track Setup on the K2 or Summit. When clips with this data are fed to an Aurora Edit Smartbin, the ancillary data can be expected to be preserved in the clip (**Preserve ANC Data** checkbox must be selected for the sequence) and allow any closed captioning in the data track to be monitored on the SDI output of an AJA Breakout Box (BOB) option.

The general conditions for preserving and viewing closed captioning in Aurora Edit are listed below.

- Closed captioning data is only displayed on ancillary data tracks. Closed captioning in the VBI will not be displayed. If a clip with closed captioning data in the VBI is rendered (to convert to another compression type, etc.) the VBI is not preserved.
- The currently supported types of closed captioning are OP-42, OP-47, EIA-608, and EIA-708. Data must be VANC (vertical ancillary) data; closed captioning in the HANC (horizontal ancillary data) is not supported.
- Preservation of ancillary data is available for both SD and HD SDI video (ANC and Line 21)

The general rules for what to expect when editing clips containing ancillary data are listed below.

- When editing with clips with an ancillary data track on the Timeline, the data can be expected to be preserved when the **Preserve ANC Data** checkbox is selected (when creating a new sequence).
- When edits are made on the Timeline, closed captioning in that frame can be expected to be read and displayed without interruption.
- When effects and graphics are placed over the clips, ancillary data can be expected to be preserved.
- When an effect involves two video tracks, such as a Resize effect with V2 over V1, the clip that is on top (V2) ancillary data will be displayed. If the top clip does not have an ancillary data track or valid closed captioning in the ancillary data track, closed captioning will not be displayed regardless of the status of the clip underneath.
- Ancillary data is not preserved over transitions (wipes, dissolves, etc.)
- Interlaced to progressive ancillary data conversions (and vice versa) are not supported. If you have a progressive clip with closed captions on an interlaced Timeline, the captions will not be displayed at the correct rate (they will most likely

play twice as fast, but they could also appear corrupt). The reverse is also true. When the progressive clip on the interlaced timeline gets transcoded the captions will not be preserved.

- The conform process will preserve ANC data on sends from Aurora Edit LD.

NOTE: *Due to the nature of closed captioning, editing a clip with closed captions can result in error prone closed captioning data due to crucial commands/characters being removed.*

Related Links

[Creating a new sequence](#) on page 94

Selecting and deselecting tracks

You can select which tracks you want to record to in the Timeline.

Aurora Edit lets you work with two video tracks and up to eight audio tracks. You can edit from any source audio track onto any record track in the Timeline.

- Click once in the track indicator on the Timeline for each track you want to select or deselect.

Selected track buttons are blue; deselected tracks are light gray.

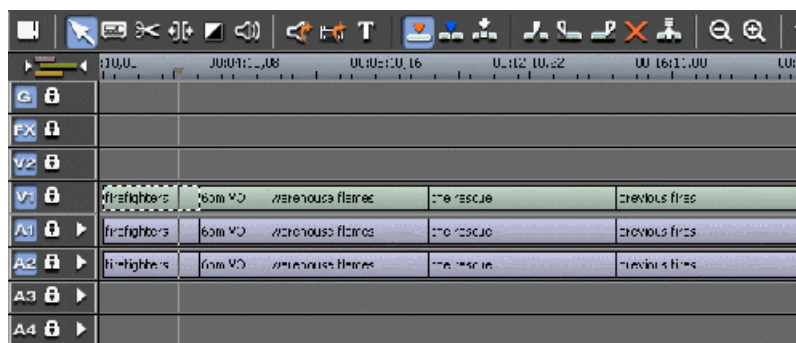



About editing modes

The Timeline has three editing modes — Overwrite mode (the default), Splice mode, and Fit to Fill, a special mode for creating motion effect clips.

For the first edit and for adding one clip after another, you can use either Overwrite or Splice mode. The difference between these modes is important when you revise and fine tune your sequence, as described in the table below.

Once you use these modes to edit clips to the sequence in your Timeline, you can move clips forward or backward within the sequence or use the Trim tool to trim transitions or to produce split edits.



The Aurora Edit editing modes are:

Tool	Icon	Keypad	Description
Overwrite		F9	Replaces existing sections of a sequence with new material, leaving the sequence duration unchanged. Similar to an insert edit in a tape-based system.
Splice		F10	Splices a clip between two existing clips in the Timeline by moving the two clips apart and inserting the new clip between. All clips after the edit point move downstream and lengthen the sequence.
Fit To Fill		F11	Fits a clip into a duration you specify in the Timeline.

Naming source tapes

You can identify which Source tape source video material comes from using Tape ID.

Tape ID lets you add a name for the Source tape before recording; you can view the tape name in the Properties tab for the clip.

1. Enable Tape ID by choosing **Tools | Options | General** and clicking **Use Tape ID for Capture**.
2. Press **2** on your keyboard or click the  **Source Tool** button.
3. Click the  **Tape ID** button; the Tape ID window appears.
4. Enter a name for the tape and click **OK**.

You can view the Tape ID by highlighting the clip in the Bin, right-clicking and selecting **Properties**.

Related Links

[Recording to the Bin](#) on page 80

Routing audio tracks

You can edit audio from any source track onto any record track in the Timeline.

You can work with up to eight audio tracks in the Timeline, though you can record only four tracks per clip. If you have two audio inputs, you may need to assign a different track to your audio source.

1. Press **2** on the keyboard or click  **Source Tool** to select the Source Tool.
2. Click the **Timeline Track** box for the Audio Input channel you need to reassign.

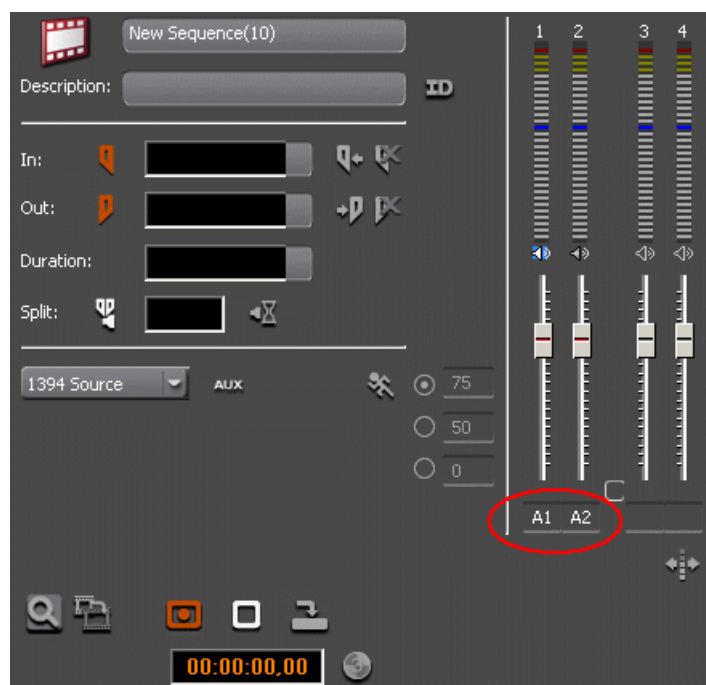

3. Select the new audio track location from the drop-down list.

Using variable speed record

Aurora Edit lets you take advantage of the Dynamic Motion Control on most tape decks and create a slow-motion or fast-motion record on the fly.

In the Source Tool, you set the speed in percentages and click them when you want a change in speed. The default speeds are 75%, 50%, and 0, which you use to create a freeze frame. Variable speed record also works with clip sources.

1. Press **2** on the keyboard or click  Source Tool to select the Source Tool.
2. Click  **Enable variable speed controls**.

The percentage windows become active.

3. Choose one of the three default speeds or enter a new percentage.

You can enter positive or negative numbers, as your deck allows.

4. Press **F12** to record your clip.

The clip records to the Timeline with the speed you chose.

NOTE: *If you are using a deck source, you can change the speed while recording the clip by clicking one of the other percentage fields.*

Selecting your source

You can select your input source from the equipment that has been set up in your working environment. Sources can include tape decks, feeds, or routers.

1. Press **2** to select the Source Tool.
2. Select a source from the drop-down menu.

The image in the viewing monitor changes to reflect the new source.

Using a clip source

You can load any clip from your Bin into the Source Tool, which effectively treats the clip like a live source such as a tape deck.

1. Drag the clip into the viewer or press **Shift + C** to load the clip.
2. Edit the footage to the Timeline as you would a tape deck.

Related Links

[Editing in the Timeline](#)

Changing sources

You can connect and configure a variety of video and audio sources as input devices to Aurora Edit.

You can also configure a non-remote source, such as a microphone or a router, as an input source and specify the tracks to select when using that input source.

1. Press **2** to select the Source Tool.
2. Select a source from the drop-down menu.

The image in the viewing monitor changes to reflect the new source.

Using auxiliary input

You can connect an auxiliary source as an input for creating sequences, which is helpful if you are using an A-B switch for controlling your sources.

When you enable auxiliary input, Aurora Edit disables deck control from the Timeline and your keyboard so you can use the device's external controls.

1. Press **2** to select the Source Tool.
2. Click the  **Use Aux Input** button.

The deck controls on Aurora Edit gray out; you can use the external controls of the auxiliary device.

Linking to an existing news or sports story

Aurora Edit can link to scripts on iNEWS, Octopus, and AP/ENPS Newsroom computer systems, which you can use as an aid for creating your sequence or linking the NCS script to add graphics or video clips to the Timeline.

You can link to a news or sports story when you create a new sequence, as described below, by opening Sequence Properties and clicking the Link to Story icon.

When an optional Orad or VizRT graphics system is installed, MOS graphic objects in the NCS script can be copied to the Graphics track on the Timeline in Aurora Edit or Aurora Edit LD. The MOS object can be retrieved from the graphics engine to a graphic on the Timeline and the editor can then preview and edit the graphic if required before sending it to playout. Orad graphics can also be sent directly to playout once retrieved to the Timeline.

Video elements from feeds started in Aurora Ingest Scheduler or archived offline assets can be brought into ENPS from a search within ENPS. The video can then be moved into the ENPS script as a MOS object. The editor can link to the script and move the MOS object into the clip player then copy it onto the Timeline.

1. Click the  **New Sequence** button in the Bin contents toolbar.

You can also link to an existing sequence by opening the sequence and clicking the Story View button in the main toolbar.

2. Click  **Link to Story**.

The Assignment List window appears, displaying available stories.

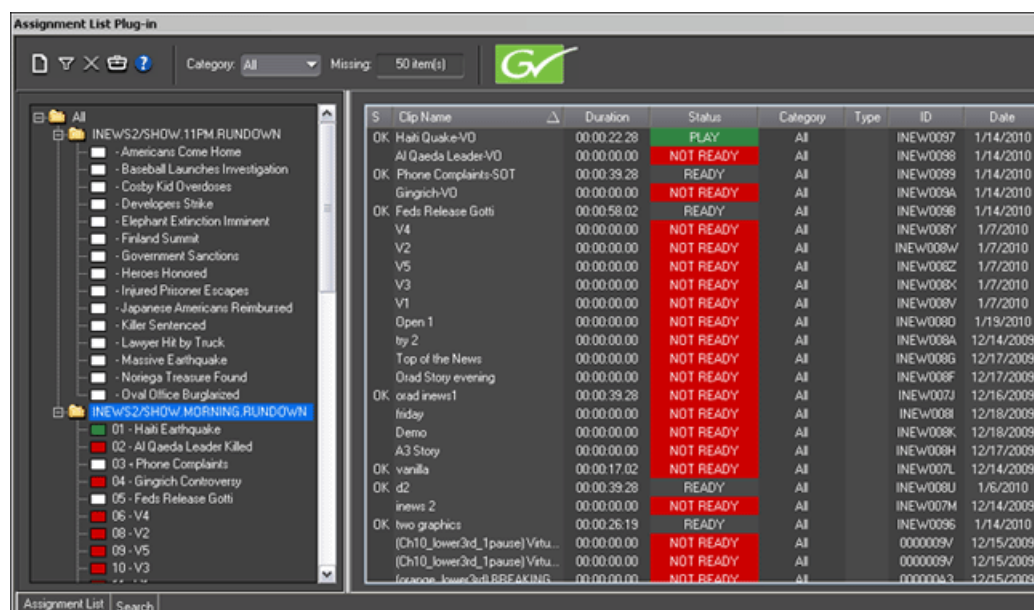

S	Clip Name	Duration	Status	Category	Type	ID	Date
OK	Habi Quake-VO	00:00:22.28	PLAY	AI		INEW0097	1/14/2010
	Al Qaeda Leader-VO	00:00:00.00	NOT READY	AI		INEW0098	1/14/2010
OK	Phone Complaints-SOT	00:00:39.28	READY	AI		INEW0099	1/14/2010
	Gingrich-VO	00:00:00.00	NOT READY	AI		INEW009A	1/14/2010
OK	Feds Release Gotti	00:00:58.02	READY	AI		INEW009B	1/14/2010
	V4	00:00:00.00	NOT READY	AI		INEW009Y	1/7/2010
	V2	00:00:00.00	NOT READY	AI		INEW009W	1/7/2010
	V5	00:00:00.00	NOT READY	AI		INEW009Z	1/7/2010
	V3	00:00:00.00	NOT READY	AI		INEW009X	1/7/2010
	V1	00:00:00.00	NOT READY	AI		INEW009V	1/7/2010
	Open 1	00:00:00.00	NOT READY	AI		INEW008D	1/19/2010
	try 2	00:00:00.00	NOT READY	AI		INEW009A	12/14/2009
	Top of the News	00:00:00.00	NOT READY	AI		INEW008G	12/17/2009
	Dead Story evening	00:00:00.00	NOT READY	AI		INEW008F	12/17/2009
OK	orad inews1	00:00:39.28	NOT READY	AI		INEW007J	12/16/2009
	friday	00:00:00.00	NOT READY	AI		INEW008I	12/18/2009
	Demo	00:00:00.00	NOT READY	AI		INEW008K	12/18/2009
	A3 Story	00:00:00.00	NOT READY	AI		INEW008H	12/17/2009
OK	vanilla	00:00:17.02	NOT READY	AI		INEW007L	12/14/2009
OK	d2	00:00:39.28	READY	AI		INEW008U	1/6/2010
	inews 2	00:00:00.00	NOT READY	AI		INEW007M	12/14/2009
OK	two graphics	00:00:26.19	READY	AI		INEW0096	1/14/2010
	(Ch10_lower3rd_1pause) Virtu...	00:00:00.00	NOT READY	AI		0000009V	12/15/2009
	(Ch10_lower3rd_1pause) Virtu...	00:00:00.00	NOT READY	AI		0000009V	12/15/2009
	(paopoe_lower3rd_1BREAKING	00:00:00.00	NOT READY	AI		0000009Z	12/15/2009

3. In the Rundown View in the left portion of the Assignment List window, expand the desired rundown by clicking the + icon.

4. In the Rundown View, click on the name of the story you want to work on.

The list of available placeholders displays in the right portion of the Assignment List window.

5. If more than one placeholder displays, select the placeholder to which you want to link.

If you know the name of the placeholder to which you want to link, you can type the first character and the active bar automatically moves to the placeholders that starts with that character. Type a few characters of the placeholder name to get to the specific placeholder and click OK.

6. Click **OK**; the Sequence Properties window appears with the name and ID filled in.

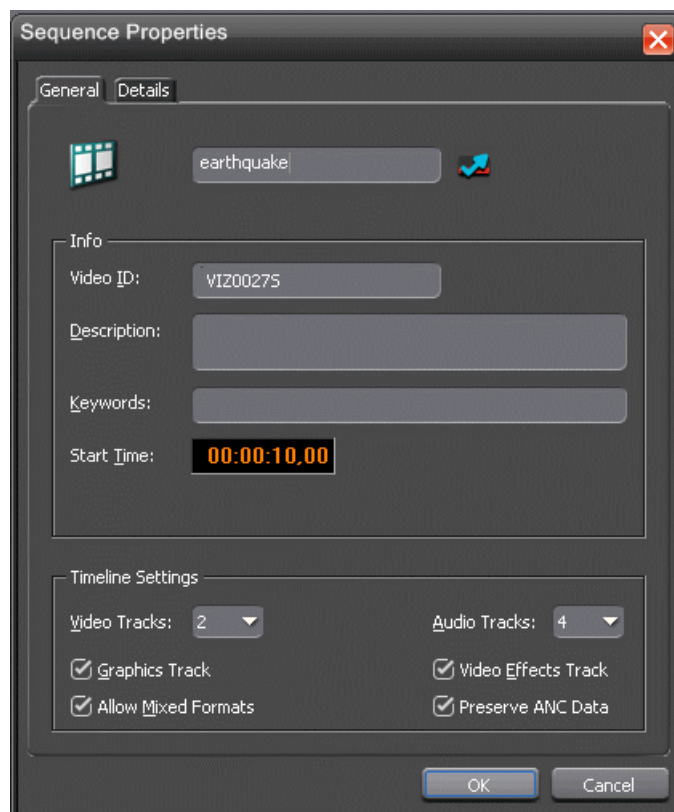

7. Click **OK** again; the Timeline opens.

Once a story is linked to a placeholder, the row color for the selected story changes to reflect that the story is being edited. The various row colors represent:

- green = playing
- blue = standing by
- yellow = stopped

- red = not ready

Related Links

[Titling and Graphics Overview](#) on page 218

[The Orad Graphics Tool](#) on page 223

[The VizRT Graphics Tool](#) on page 228



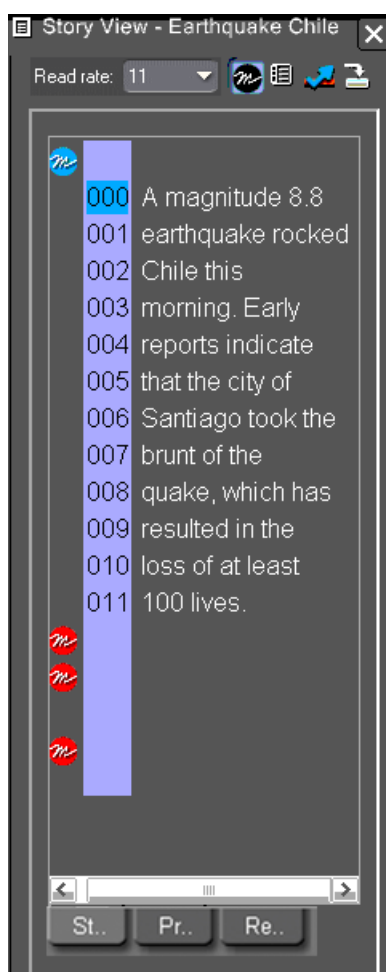

Story View functions

To view the script from a newsroom computer system, select the  **Story View** button in the top menu bar. The Story View window will open showing the script and any MOS objects that can be copied to the Graphics track of the Timeline and rendered as graphics when an optional Orad or VizRT graphics system is installed.

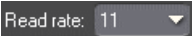

If the Story View has a **Resources** tab at the bottom of the window, this indicates there are also video MOS elements linked to the script that can be placed in the Aurora Edit Clip Player and copied to the Timeline.



Item	Icon	Function
Read Rate		<p>Displays the current Read Rate in characters per second.</p> <p>Click the arrow to select a specific script reader's (newscaster's) reading speed.</p> <p>Click Reset to return to the default reading rate.</p> <p>Click Off to turn off the Read Rate function.</p>
Refresh Script		<p>Refreshes the Story View with any script changes made on the NCS side. If the script is updated on the NCS while in Manual mode, the Refresh Script icon flashes yellow for 30 seconds and then remains yellow to indicate that an updated script is available. Click Refresh Script to load the updated script and revert the Refresh Script icon to green.</p>
Media Object Server (MOS) Object Display Toggle		<p>Toggles the MOS Object Display function on and off.</p> <p>When on, an icon marks where placeholders have been put in the script. When off, the placeholder icons disappear from the screen.</p>
Production Command Toggle		<p>Toggles the production command (e.g., wipe, package, out cue, anchor, etc.) display column on and off.</p>
Link Sequence to Story		<p>Links a sequence to the Assignment List where the editor can access a script from the news .</p>

Item	Icon	Function
Copy to Timeline		From the Story View, copy the MOS object(s) on the left of the Story View to the Timeline Graphics track.

Related Links

[Moving Orad MOS objects into Aurora Edit](#) on page 225

[Moving VizRT MOS objects into Aurora Edit](#) on page 231

[Linking video MOS objects to the Timeline](#) on page 180

Adjusting the read count in Story View

Aurora Edit allows you to manually modify the Story View read count to match your timeline.

1. Click  **Story View** in the Main Toolbar.
The Story View window opens.
2. Double-click on the read count number that you want to change.
3. Type a new value that indicates the number of seconds into the script, then click **Enter**. For example, if you wanted to insert a 20 second SOT 6 seconds into the script, you could enter 26.

A gap appears in the read count.

Read count adjustments will be reset if you close the Story View window or choose **Reset** from the read rate dropdown list.

When you play a sequence, the Timeline position cursor moves, and the blue highlight in the Story View window moves in concert to match the current Timeline position.

Using the Assignment List Manager

The Assignment List Manager is for editors to receive assignments from the producer, to create additional placeholders for clips, and to reassign placeholders to other editors.

The embedded Assignment List Manager runs on the Aurora Edit workstation and integrates with Aurora Edit; the Aurora Edit toolbar displays part of the Assignment List Manager so you can see the number of assignments you've received.

- In Aurora Edit, double-click the **Missing** box to open the Assignment List window:

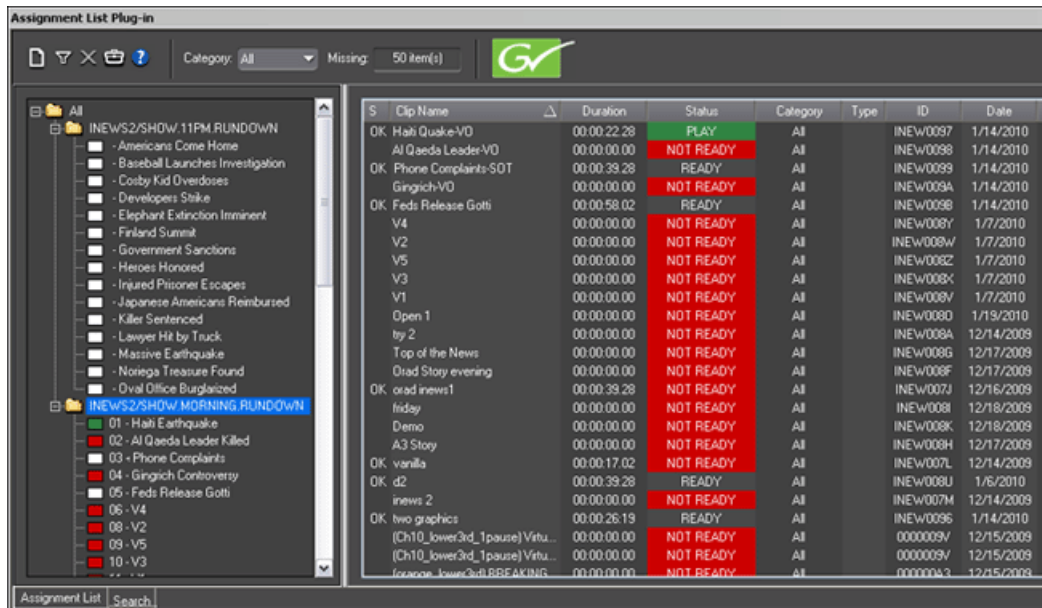

The list of assignments shows each clip/placeholder and its properties:

Column	Description
S	The clip status: displays OK if a clip has been completed, sent to the media server, and is ready for playback. Status is blank if a clip is incomplete and not ready for playback.
Clip Name	The name of the clip/placeholder.
Duration	The duration of the clip when the placeholder was created. This estimated value will be changed later when media is associated with the placeholder. A duration displayed in italics in the Assignment List indicates that the Editorial Duration property has been set to be different than the actual duration of the clip.
Status	MOS status: matches the NCS status. Includes READY/NOT READY, PLAYED, etc.
Category	The category assigned to the clip; you can assign categories based on the editor to receive the assignment, for instance.
Type	The type of story or sequence an editor needs to create: Voice Over (VO), Sound on Tape (SOT), or other types set in SDB Server Options.
Description	Brief description of the clip an editor needs to create.
Clip ID	The clip ID, which is automatically defined when the placeholder is created.
Date	The date the placeholder was created.

Column	Description
P (Protected)	Protected status; displays P if the clip is protected, which prevents it from being erased or deleted from the database. Column is blank if the clip is unprotected.

Once a story is linked to a placeholder, the row color for the selected story changes to reflect that the story is being edited. The various row colors represent:

- green = playing
- blue = standing by
- yellow = stopped
- red = not ready

Editing and Aurora Playout

News editors use the Assignment List Manager component of Aurora Playout to receive assignments from the producer and return completed assignments.

Producers create those assignments as clip placeholders for use in an upcoming news broadcast. You create clips in Aurora Edit and link them to the placeholders in the Assignment List Manager.

The Assignment List Manager runs on the computer with the Aurora Edit editing system. Editors create clips and sequences in Aurora Edit as usual and send them to a media server. A playlist is received from the NCS or a playback operator uses the clips in Aurora Playout to create a playlist, and then controls the playback of clips to air.

With MediaFrame integration, you can add general metadata, keywords and custom metadata on a placeholder. Once the metadata is added, it will be searchable and editable throughout all MediaFrame clients.

Creating placeholders in the Assignment List

In addition to the assignments you receive from your producer, you can create additional placeholders for clips you want to include in a broadcast.

1. Click the  **New Clip** button.

The New Clip Entry window appears with Settings tab and Metadata tab (if MediaFrame is configured):

2. Enter a clip name.

The placeholder name identifies the placeholder in your Assignment List Manager, the Assignment List Plug-in on the ENPS system, and the Aurora Playout playlist.

3. Optionally, enter additional information about the placeholder:

- **Story Type**— If desired, specify whether this is a SOT (story on tape), VO (voice over), etc.
- **Description** — Enter a description for the placeholder to help identify the clip you need to create.
- **Category** — Select a category from the drop-down menu. The category determines who receives the placeholder as an assignment. Selecting **ALL** makes the placeholder accessible to all editors who select **ALL** in their Assignment List Manager.
- **Editorial Duration** — If desired, enter an estimated duration for the story or select one from the drop-down list. The editor can also enter an editorial duration that is less than the clip length, which is sent back to the NCS for show timing.

NOTE: Editorial Duration has the priority over media duration. Once an Editorial Duration is set; it will not be adjusted to clip duration, even after media is associated with the placeholder. The editor needs to set the final Editorial Duration before the clip is sent for playback.

- **Protected** — Check this box to prevent the clip from being deleted from the database.
- **Being Edited** — Check this box to show that the clip for a placeholder is being edited. This field allows editors to easily see that a clip is already being worked on in another edit room.

NOTE: This field allows users to easily determine that a clip is already being worked on. When checked, these areas designate that the clip is Being Edited: the clip in the Aurora Payout playlist and in the Assignment List Manager changes color, and the text for the clip in the standalone Assignment List Manager changes color.

4. If you already configured MediaFrame for use with Aurora Payout, you can enter metadata for the placeholder in the Metadata tab.
 - **Name** — The name of the clip will be the same as the one that you entered in the Settings tab.
 - **Source** — Enter the source of the clip.
 - **Expires** — Select the expiry date for the placeholder. If no expiry date is needed, you can leave it as the default setting: Not Defined.
 - **Description** — The description will be the same as the one that you entered in the Settings tab.
 - **Search Terms** — Enter the search term for the clip so that it will be easy to find when you search for it using MediaFrame Search component later.

You can also enter metadata within Keywords tab, which referenced a specific location in the media file. This is done by selecting mark-in/out points on the clip and a keyword will be assigned automatically for that segment.

Within the Custom tab, you can enter additional metadata for the asset such as editor, videographer, location and any other fields that have been listed. If you have the Administrator privileges, you can add, edit, or delete the metadata list.

5. Click **OK**.

The Clip ID and Date are automatically set when you create the placeholder.

Viewing by category in the Assignment List

In the Assignment List Manager, you can choose to view assignments within a selected category or all of the assignments in the list.

Select a category from the **Category** drop-down list.



The list displays only the placeholders and clips in that category.

Select **All** to view all assignment placeholders again.

Changing the clip category in the Assignment List

If you need to, you can change a clip or placeholder category in the Assignment List Manager.

1. Right-click on the placeholder and select **View Properties**.
2. Select a new editor, workstation name, or other category from the **Category** list.



3. Click **OK**.

The placeholder appears on the edit workstation when that particular category is selected.

Identifying missing clips

In the Assignment List Manager, you can filter the list of clips to show only missing clips.

Click the  **Missing Clips Only** button.

Only placeholders with missing clips will be shown on the Assignment List Manager.

Click the button again to show the entire clip list.

Deleting placeholders in the Assignment List

If you need to, you can delete placeholders from the Assignment List Manager.

However, deleting items using the Assignment List Manager only deletes the placeholder, not the corresponding media. For this reason, you should only delete empty placeholders from the Assignment List Manager and use Housekeeper for deleting clips.

1. Select the placeholder that you want to delete and click the  **Delete** button.
2. Click **Yes** to answer the question, "Permanently delete selected placeholder(s)?"

The placeholder is deleted from the Assignment List.

Working in the Timeline

This section contains the following topics:

- *Understanding Aurora Edit's Agile Timeline*
- *Mark Points*
- *Setting up a split edit*
- *Controlling a deck from Aurora Edit*
- *Zooming in on a clip source*
- *Changing the Timeline view manually*
- *Using Auto-Scale to adjust the Timeline view automatically*
- *Toggling tracks on the fly*
- *Moving clips*
- *Using Quick Edit mode*
- *Creating your clips*
- *Playing a sequence*
- *Saving a sequence*
- *Splitting clips*
- *Lifting clips*
- *Deleting clips*
- *Saving the Timeline track configuration*

Understanding Aurora Edit's Agile Timeline

Aurora Edit allows you to mix and match video formats in real-time within the same Timeline.

Administrators can enable mixed-format (Agile) Timelines from **Tools | Options | Timeline** by checking the **Allow Mixed Format Timeline** checkbox. When this setting is enabled, users are given the option to enable mixed formats when creating a Timeline.

While Aurora Edit allows this real-time mixing and matching of formats within a Timeline, all clips that differ from the Timeline's default video format must be transcoded when sent to a media or playout server. With this in mind, editors may choose to enable or disable mixed-formats on a per-Timeline basis, depending upon their needs. This feature can be configured from the New Sequence or Sequence Properties window.

When disabled, clips that don't match a Timeline's format are transcoded when they are added to the Timeline. When enabled, clips that differ from the Timeline format appear with a blue bar above the clip to indicate that transcoding will take place when the sequence is sent.

Clips on a Timeline, as well as other effects, are transcoded by selecting **Render All**. You can also manually transcode a clip by right-clicking on it and choosing **Render Selected**.

NOTE: Aurora Edit LD cannot render. The conform process will handle this.

If not transcoded prior to sending, Aurora Edit transcodes them automatically when they are sent via either the local editing machine or a Conform Server.

Note that NTSC and PAL formats cannot be mixed on the Timeline.

Mark Points

About Mark Points

You can set the Mark Points using the Mark In and Mark Out buttons in either the Timeline Tool or the Source Tool.

The steps to create a mark point are the same regardless of which tool you are using, but you will be setting different mark points in the two tools. In the Timeline Tool, you are setting mark points for your sequence; in the Source Tool, you are setting mark points for the input source.

When you make the first edit in a sequence, you can mark In and Out points (optional). If you don't set a Mark In point, recording starts at the current position of the cursor. If you don't set a Mark Out, Aurora Edit creates an Out when you stop recording and

the clip is edited into the Timeline. The Timeline automatically moves the cursor to the end of each edit in preparation for the next edit.

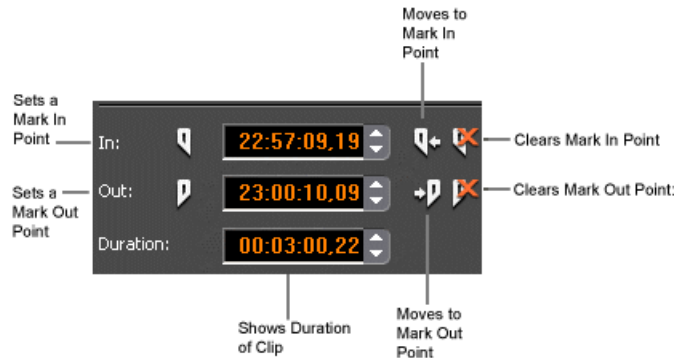

Marking In and Out Points

You create mark points to determine which material to record for your sequence.

1. Move to the Mark In or Mark Out point in any of the following ways:
 - Click the point on the Timeline where you want to place the points.
 - Press the **A**, **S**, **D**, or **F** keys on the keyboard to jog through clips in 1-frame or 10-frame increments.
 - Press **G** to move back to the previous cutpoint.
 - Press **H** to move forward to the next cutpoint.
2. Press **I** on the keyboard to Mark In and press **O** to Mark Out.

Related Links

[Creating transitions for an area of the sequence](#) on page 142

[Trimming sequences in the playlist](#) on page 243

Setting up a split edit

Aurora Edit lets you set In and Out points to create a pre-defined split edit from the Timeline Tool.

To delay one of the tracks at the beginning of a clip, set different In points for the video and audio, with one starting after the other. You can also extend one track after the other at the end of a clip.

If your clips are already recorded to the Timeline, you can create a split edit using the Cut Point Edit Tool or by extending the edit.

1. Press **1** on the keyboard or click  **Timeline Tool** to select the Timeline Tool.

2. Press **I** on the keyboard to mark an In point for the video track.
3. Click the  **Show Audio Marks** button.

Blue icons indicate audio mark in and out points.

4. Select a Mark In Point for the audio track.

The duration of the split appears in the Duration field.

5. Record your clip.

Related Links

[Changing cut points](#) on page 129











[Extending your edits](#) on page 131



Controlling a deck from Aurora Edit

If you are using a tape deck, you can control it from the Aurora Edit window or keyboard. Aurora Edit provides transport control buttons like those on a tape deck, which control the Timeline, clip source, and Deck.

Use these controls to locate the material you want to record as a clip. Then use the marking controls to mark the clip or use the transport control buttons on your deck to locate your Mark In and Mark Out points.

1. Use any of these controls to locate the material you want to record as a clip:

Button	Function
	Ejects the tape.
	Rewinds the tape.
	Plays the tape.
	Fast forwards the tape.
	Stops the tape.
	Moves through the tape (drag the shuttle forward or backward).
	Jogs one frame back.
	Jogs 10 frames back.
	Jogs one frame forward.
	Jogs 10 frames forward.
	Shuttles left in increments of -50%, -75%, -1x, -2x, -3x.

Button	Function
	Shuttles right in increments of +50%, +75%, +1x, +2x, +3x.
	Resets shuttle speed to the default (200%); to change the default speed select Tools Options Timeline Default Play Speed and enter the new speed.
	Selects previous shuttle speed.

2. Create mark points using one of the following methods:
 - Use the marking controls to mark the clip
 - Use the transport control buttons on your deck to locate your Mark In and Mark Out points.

Zooming in on a clip source

Aurora Edit lets you zoom in on a portion of a clip in order to provide better scrubbing and marking capability.

When a clip is opened in the Trim Tool or Clip Source Tool, you see a scrubber bar with a zoom knob to the right.

The parts of the player are:

- **Clip timeline**—This bar displays the current position of the clip and the mark in and mark out points.
- **Keyword bar**—This bar shows a visual indication of keywords or keyframes that have been added through MediaFrame components in the news workflow.
- **Zoom indication bar**—This bar shows a visual representation of the current ratio of the clip timeline versus the overall clip duration.
- **Zoom dial**—This control changes the zoom level of a clip, using zoom levels of Full, 5 minutes, 2 minutes 1 minute, 30 seconds, 15 seconds, 10 seconds, 5 seconds, 2 seconds, and 1 second.



Tips for using the zoom controls

Aurora Edit provides you with multiple methods for using the zoom controls when viewing media.

There are a few ways to zoom in on media in the viewing window:

- The fastest way to zoom is to hover over the clip timeline, hold the CTRL key down, then move the mouse wheel forwards or backwards. You can also move the mouse wheel forward and backward without holding the CTRL key, which moves the position of the pointer, thus increasing the speed when used in conjunction with the CTRL zoom.
- Another way to zoom is to hover over the zoom dial and move the mouse wheel forwards or backwards.
- You can also zoom by manually moving it. Click the zoom dial with your mouse and drag the zoom dial clockwise or counterwise. It's best to hold the mouse and pull away from the dial as you move, providing greater granularity.

Once a clip has been zoomed in, the zoom indication bar provides you with a visual representation of the zoom percentage. You can select and drag this bar through the entire clip. This works as a zoom window that can be placed wherever you like within a clip. Once stopped, you can easily access the clip timeline scrubber above and move easily within the zoom window.



Changing the Timeline view manually

You can zoom in and out of the Timeline to see a specific area of the Timeline or to get an overall perspective of your sequence.

Use one of these methods to change the Timeline view:

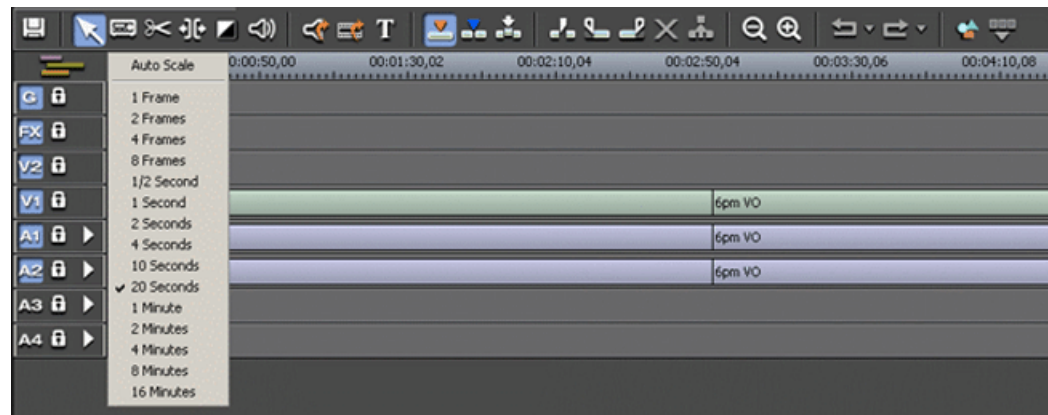
- Right-click the  **Turn Auto-Scale On/Off** button (shown in Auto-Scale Off) and select an increment for the Timeline view to display



- Press **+** on your keyboard or click the  **Zoom In** button in the Timeline Toolbar to zoom in the Timeline view. Press **-** or click the  **Zoom Out** to zoom out the Timeline view.

Related Links

[Using Auto-Scale to adjust the Timeline view automatically](#) on page 117



Using Auto-Scale to adjust the Timeline view automatically

Use Auto Scale to have the Timeline view adjust automatically when your sequence extends beyond the Timeline view.

- Click the  **Turn Auto-Scale On/Off** button in the Timeline.

The Timeline view compresses and displays the entire sequence in the Timeline each time the sequence extends beyond the Timeline window.

To turn off Auto-Scale, click  **Turn Auto-Scale On/Off** again.

NOTE: Auto-Scale turns off automatically once you click  **Zoom In** or  **Zoom Out** on the Timeline toolbar.

Related Links

[Changing the Timeline view manually](#) on page 117

Toggling tracks on the fly

While you are editing in the Timeline, you can select and deselect tracks at the same time you add clips.

- Click once in the track indicator on the Timeline for each track you want to select or deselect.

Selected track buttons are blue; deselected tracks are light gray.

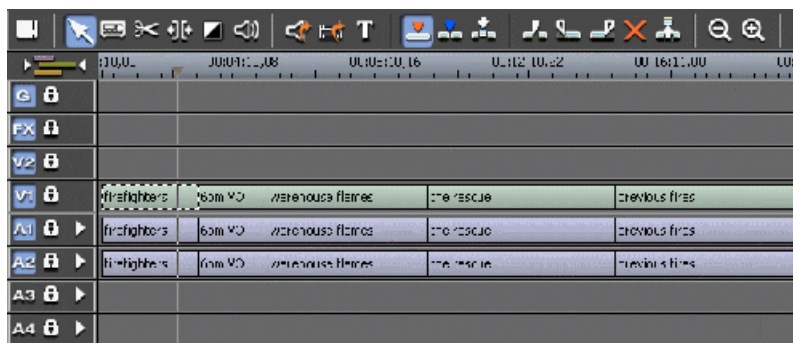

Moving clips

Moving clips in the Timeline

You can rearrange your clips in the Timeline by dragging clips to a new location or using keyboard keys to move your clips.

When you move clips in the Timeline, the result differs slightly based on the current edit mode. If you are in Overwrite Edit Mode, a moved clip covers other clips. If you are in Splice Edit Mode, a moved clip pushes other clips out.

1. Press **1** on your keyboard or click  **Timeline Tool** to choose the Timeline Tool.
2. Click once on the clip in the Timeline you want to move.

An outline appears around the clip you selected.

3. Drag the clip to its new location.

You can also use the following keyboard keys to move clips:

Keyboard Keys	Function
Numberpad 4	Moves the selected clip one frame to the left on the Timeline.
Numberpad 6	Moves the selected clip one frame to the right on the Timeline.
Ctrl + Numberpad 4	Moves the selected clip 10 frames to the left on the Timeline.
Ctrl + Numberpad 6	Moves the selected clip 10 frames to the right on the Timeline.
Z	Moves the selected clip to the previous cut point.
X	Moves the selected clip to the next cut point.

Moving audio clips

You can move an audio clip to any of the eight Aurora Edit audio tracks.

- Drag the audio clip to the desired track.

Copying clips to the Timeline

You can copy clips from the Bin or another sequence to the Timeline for use in a sequence.

Use one of the following methods to copy selected clips to the Timeline:

- When the video source is active in the viewer, click the  **Copy To Timeline** button
- Press **C** on the keyboard
- Drag the clip from the Bin to the Timeline
- Right-click on the clip in the Bin and select **Copy To Timeline**

Copying and pasting clips

In the Timeline, you can copy and paste items, such as video and audio clips, graphics, effects, and transitions.

1. Use one of these methods to select the item(s) to copy or delete:
 - Click once on the clip or track in the Timeline
 - Lasso the area in the Timeline
 - Mark an In and Out point
2. Right-click in the Timeline (with the item selected) and select an action:
 - **Delete Selected**
 - **Lift Selected**

- **Copy Selected**
 - **Cut Selected**
3. If you are pasting a clip or area, place your cursor on the Timeline at the location where you want to copy the material, right-click again and select **Paste Selected** or **Paste Track**.

Copying a selected area of a sequence

In addition to copying clips in your sequence, you can also copy a selected area of a sequence to copy or delete.

Remove any mark points from your sequence before pasting material; Aurora Edit pastes material at the Mark Out point.

1. Mark an In Point at the start of the material to move.
2. Mark an Out Point at the end of the material.
3. Turn off any tracks you don't want to cut or copy.
4. Right-click in a track and select one of these functions:
 - **Cut Area**
 - **Copy Area**
 - **Delete Area**
 - **Lift Area**
5. If desired, paste the material into another part of this sequence or another sequence.

Using Quick Edit mode

Quick Edit mode switches you to the Source Tool after an edit to the Timeline, which is good if you prefer to lay down all of your edits and then go back and review your sequence.

1. Press **2** to select the Source tool.
2. Click the  **Quick Edit** button.

You are now in Quick Edit mode.

To stop Quick Editing, click the Quick Edit button again.

Creating your clips

You create clips to make your sequence.











1. Play the source to find the media you want.
2. Press **F12** to start recording.

3. Press the **spacebar** to stop recording immediately, or press **O** on your keyboard to stop recording after adding Out handles.
4. Play the sequence.
5. Repeat these steps for each additional clip in your sequence.

Playing a sequence

As you create a sequence, you may want to review the progress. With Aurora Edit, you can play the sequence as part of the editing process in the Timeline.

1. Select the Timeline Tool by pressing **1** on the keyboard or clicking  Timeline Tool.
2. Select one of these commands to play or work through the sequence:

Command	Icon	Keyboard Key	Description
Back 1 Frame		A	Moves the position indicator one frame to the left.
Forward 1 Frame		S	Moves the position indicator one frame to the right.
Back 10 Frames		D	Moves the position indicator ten frames to the left.
Forward 10 Frames		F	Moves the position indicator ten frames to the right.
Play From Start		Q	Starts playing from the beginning of the sequence.
Rewind		E	Rewinds the sequence.
Play		W or Spacebar	Starts playing from the position of the cursor.
Fast Forward		R	Fast Forwards the sequence.
Stop		Spacebar	Stops playing the sequence.
Loop Playback		--	Plays the sequence in a continuous loop.
N/A		Left arrow	Shuttles left in increments of -50%, -75%, -1x, -2x, -3x.
N/A		Right arrow	Shuttles right in increments of +50%, +75%, +1x, +2x, +3x.
N/A		Up arrow	Resets shuttle speed to default, which is 200%.

Command	Icon	Keyboard Key	Description
N/A		Down arrow	Selects previous shuttle speed.

Saving a sequence

You need to save your sequence periodically to your workstation Bin or to the shared database.

- Press **Ctrl + S** on the keyboard or click the  **Save** button in the Timeline toolbar.

Aurora Edit saves the sequence in the Bin where you created it.

Splitting clips

You can split an existing clip into two clips. For example, you can insert new material between two split sections or split a clip and remove a piece to tighten the sequence.



1. Press **1** on the keyboard to choose the Timeline Tool.
2. Drag the cursor to the spot where you want to split the clip.

You can also use the **A**, **S**, **D**, and **F** keys to find the split point.

3. Press **** on the keyboard or click the  **Split Clip** button on the Timeline toolbar.

The clip splits in two.

To split only one of the tracks (for example, split the Video track and leave A1 and A2 intact), deselect the track button at the left of the Timeline for tracks you want to be unaffected by the split.

Lifting clips

Lifting clips from the Timeline

You can lift a clip out of a sequence to replace it, or remove a piece of a clip from a sequence after splitting it. Black or silence replaces the lifted portion.

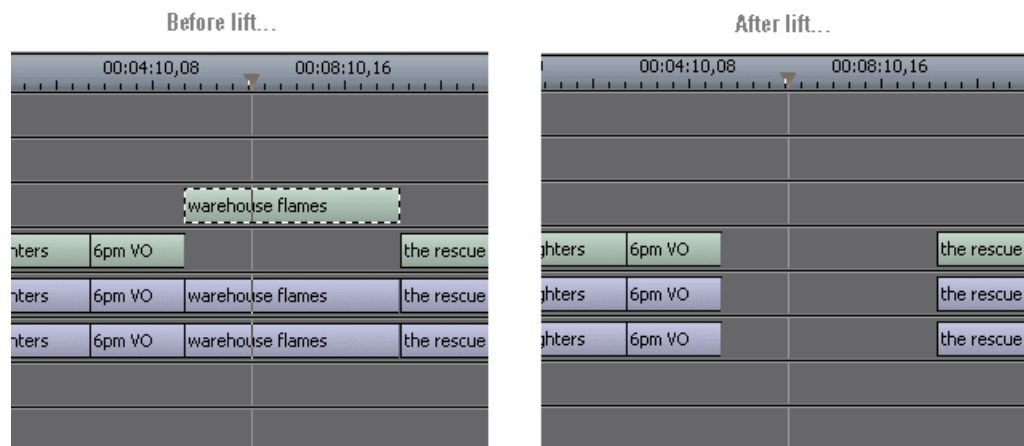

1. Press **1** on your keyboard to choose the Timeline Tool.
2. Click once on the clip you want to lift.
3. Press **J** on the keyboard or click the  **Lift Clip** button on the Timeline toolbar.

The clip disappears from the sequence.

To fill in the gap created by lifting a clip, Select the first clip after the gap and press **0** on the keyboard or select **Collapse Sequence** from the Command menu. The hole to the left of the selected clip closes. You can also use the **Delete** key to completely remove the clip and close the gap in a single step.

Lifting an area of a sequence

You can also lift an area of the sequence that includes parts of adjoining clips.



1. Press **1** if you are not already in the Timeline Tool.
2. Select the area to lift by marking an In and an Out point.
3. Press **Ctrl + J** on the keyboard or hold down the **Ctrl** key while clicking the  **Lift Clip** button.

You can also right-mouse click in the Timeline and select **Lift Area**.

Deleting clips

Deleting a clip from your sequence

Instead of lifting a clip from the Timeline you can delete a clip and close the gap between the remaining clips in the sequence.

Before deleting an individual track on a clip, be sure to deselect the tracks you don't want to delete by clicking their track indicators on the Timeline.



1. Press **1** on your keyboard to choose the Timeline Tool.
2. Select the clip in the Timeline that you want to delete. Press the **Ctrl** key to select multiple clips.
3. Press **Delete** on your keyboard.

The clip disappears from the Timeline.

Deleting an area from a sequence

You can delete an area of the sequence, which can include parts of adjoining clips.

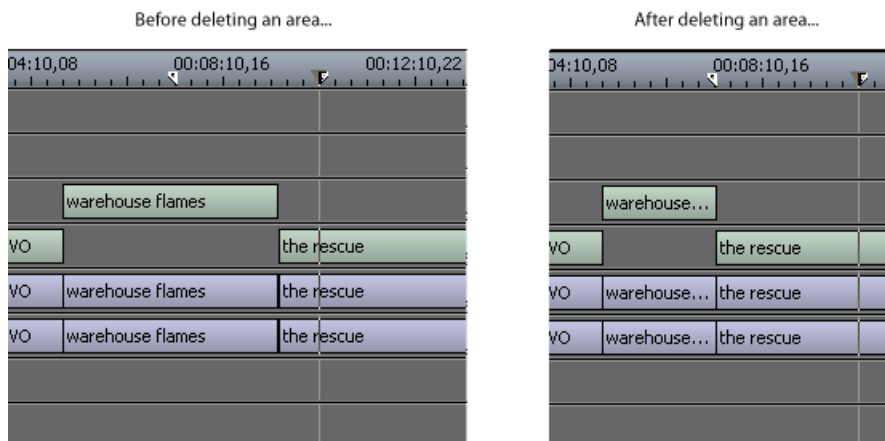

1. Press **1** on your keyboard to choose the Timeline Tool.
2. Select the area to delete by marking an In and an Out point.
3. Right-click in the Timeline and choose **Delete Area**.

Saving the Timeline track configuration

With Aurora Edit, you can save the current positions of the tracks in the Timeline and use these settings for future timelines.

Settings that get saved are:

- Sync lock
- Track activation
- Track height
- Waveform zoom level
- Show/hide audio waveform and fade control points

1. Make adjustments to the tracks until you are satisfied with the settings.
2. Select **Window | Save Track Configurations**.

Each new timeline uses these settings.

Trimming clips

This section contains the following topics:

- *Trimming your clips*
- *Using handles to add frames to your clips*
- *Locking the duration of a clip*
- *Playing Past Out*
- *Changing cut points between adjacent clips*
- *Extending your edits*
- *Trimming your media clips in the Bin*

Trimming your clips

You may often need to shorten your clips or change the starting or ending frame. In Aurora Edit you trim clips by changing the Mark In and Mark Out points.

1. Click once on the clip you want to trim to select it.
2. Press **3** on the keyboard or click the  **Trim Tool** button in the Timeline toolbar.

The Trim window appears.

3. To trim the beginning of a shot, press the **spacebar** to play the clip and press the **spacebar** again to stop at the frame where you want the clip to start.

You can also use the slider to find the approximate In point and then use the **A**, **S**, **D**, and **F** keys on the keyboard to find the exact spot.

4. Press **I** on the keyboard to mark a new In point.
5. To trim the end of the same clip, play the clip again and stop at the frame where you want the clip to end.
6. Press **O** on the keyboard to mark a new Out point.
7. Continue trimming other clips in your sequence.

Related Links

[Trimming your media clips in the Bin](#) on page 132

Using handles to add frames to your clips

If you have recorded handles with your clips, you have additional frames to choose from when trimming your clips.

1. In the Trim Tool, click the  **Add Handles** button.

The handles appear as additional frames on the slider in the Viewing Monitor.

2. Mark new In and Out points for your clip using the additional material.

Locking the duration of a clip

Sometimes you need to trim a clip while maintaining its duration. The Lock Duration feature allows you to keep the clip duration constant while trimming by using the extra frames in the handles and adjusting the clip.

For instance, if you move the Mark In point 5 frames from the beginning of the clip, the Mark Out point moves automatically 5 frames to maintain the duration.

- In the Trim Tool, click the  **Lock Duration** button.

Playing Past Out

Playing Past Out lets you create an Out point on the fly while viewing media after the Mark Out point, which is useful when verifying the Out point.

1. In the Trim Tool, click the  **Play Past Out** button.
2. Play the clip.

The clip continues playing past the Mark Out point, letting you see the rest of the footage in the clip.

Changing cut points between adjacent clips

About adjusting cut points

You may need to adjust the cut points between two clips in the Timeline.

When you edit part of a clip into your sequence, Aurora Edit recognizes that there is more material in the clip than is being used in the edit. The Cut Point Edit Tool lets you access the unused portion of the clip without returning to the source clip and repeating the edit.

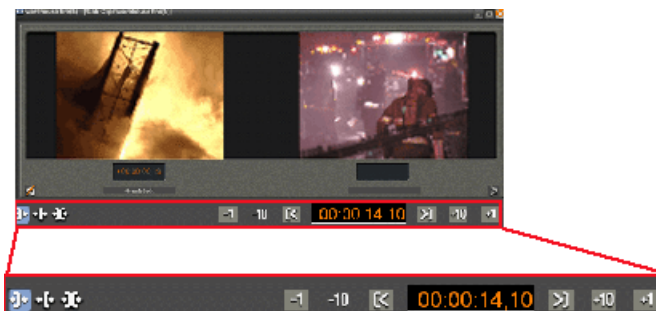



Changing cut points

Adjust the cut points between two adjacent clips by trimming the Out point of the first clip, the In point of the second clip, or both.

1. Select the tracks you want to edit in the Timeline.
2. Move to the appropriate cut point in the Timeline:
 - Press **H** on the keyboard to move to the next cut point.
 - Press **G** on the keyboard to move to the previous cut point.
3. Press **4** on your keyboard or click the  **Cut Point Edit Tool** button in the Timeline toolbar.

The Cut Point window appears showing the two clips you want to trim.

4. Choose one of the following ways to trim:

Option	Icon	Description
Trim Mark Out		Extends or retracts the Out point of the first clip; changes the duration of a sequence.
Trim Mark In		Extends or retracts the In point of the second clip; changes the duration of a sequence.
Trim Both		Simultaneously manipulates the Out point of the first clip and the In point of the second clip. This method extends L-cuts without changing the sequence duration.

5. Choose how much you want to trim the cut point(s) by:
- Dragging the cut point in the Timeline to the new position.
 - Using the cut point navigation tools to select the new frame position.
6. Click **Apply** or press **Enter** on the keyboard.

The Timeline updates with the new cut point.

Related Links

[Setting up a split edit](#) on page 113

[Extending your edits](#) on page 131



[Creating split edits](#) on page 171





Navigating to cut points

Aurora Edit provides some quick ways to navigate through your clips to find the frames you need for trimming.

You can either click the buttons in the Cut Point Edit Tool or press the corresponding keys on the keyboard.

Use these tools to navigate through your sequence:

Icon	Keyboard Key	Description
	A	Moves back 1 frame.
	D	Moves back 10 frames.

Icon	Keyboard Key	Description
	Z	Extends to the previous cut point.
	X	Extends to the next cut point.
	F	Moves forward 10 frames.
	S	Moves forward 1 frame.

Using audio scrubbing

Digital audio scrubbing allows you to jog through your material while monitoring the audio. Use audio scrubbing to locate your audio edit points.

- In the Cut Point Edit Tool, click  **Enable Audio Scrubbing**.

Extending an individual track

You can use the Cut Point Edit Tool to extend an individual track (video or audio) over the track in the next clip.

1. Press **4** on your keyboard to select the Cut Point Edit Tool.
2. Deselect any tracks you don't want to extend by clicking once in the track indicator on the Timeline for each track you want to deselect.

For example, to extend an audio track only, deselect the video track.

3. Put the cursor at the beginning of the track you want to extend.
4. Move to the next or previous cut point using the buttons or the **Z** and **X** keys on the keyboard.
5. Press **Enter** to extend the edit over the clip.

Extending your edits

Aurora Edit provides a quick way to extend an edit without having to re-record any footage. Use this feature to extend an individual track (video or audio) over the track in the next clip.



1. Deselect any tracks you don't want to extend.

To deselect a track, click once in the track indicator on the Timeline for each track you want to deselect.

2. Highlight the clip you want to extend.
3. Move the cursor to the position you want to extend the clip to.
4. Press **V** on your keyboard.

The clip extends into the next clip. If the clip doesn't have enough handle material to extend as far as you select, Aurora Edit extends it as far as it can.

You can also shorten a clip using this method by marking an In point on a clip and pressing **V** on your keyboard.

Related Links

[Setting up a split edit](#) on page 113

[Changing cut points](#) on page 129

Trimming your media clips in the Bin

You can trim clips in the Bin without putting them into the Timeline.

For example, you can record a long section of tape and then create shorter individual clips to edit into a sequence. This process is the same as editing clips in the Timeline, but you can also create subclips using this method. Subclips allow you to create shorter clips without changing the original recorded clip.

1. Double-click the media clip you want to trim.
The Trimmer window appears.
2. Press **W** on the keyboard to play the clip.
3. Press the **I** and **O** buttons on the keyboard to mark new edit points.

To see the extra recorded material, click the  **Add Handles** button.

4. Click **OK**.

You can also drag other clips into the Trimmer without having to close and reopen the Trimmer window.

Related Links

[Trimming your clips](#) on page 128

Creating SubClips

If you want to create a shorter clip from a larger recorded clip, you can create subclips.

1. Press the **I** and **O** buttons on the keyboard to mark new edit points.
2. Click  **Create SubClip** on the Bin Trimmer window.
3. Name the subclip and click **OK**.
4. Close the Trimmer and click **No** to save changes; otherwise, the master clip will be modified.

Copying a clip to the Timeline

Aurora Edit allows you to copy a portion of a larger recorded clip directly to the Timeline.

1. Open a sequence window if one is not open.
2. Press the **I** and **O** buttons on the keyboard to mark new edit points.
3. Press **C** on the keyboard or click  **Copy to Timeline** on the Bin Trimmer window.

The smaller clip copies to the Timeline at the insert point and is ready for editing.

A quick way to edit

You can edit a sequence quickly using these steps.

1. Click  **Play Past Out** on the Bin Trimmer window.
2. Play the clip.
3. Mark an In point.
4. Mark an Out point.
5. Copy to the Timeline by pressing **C** on the keyboard while the clip is playing.
6. Repeat steps 3-5 to continue your edits.

Transitions

This section contains the following topics:

- *Transitions in Aurora Edit*
- *Understanding transition types*
- *Creating a transition*
- *Changing transitions*
- *Creating wipes*
- *Rendering transitions*
- *Creating transitions for an area of the sequence*
- *Deleting transitions*
- *Audio crossfades*

Transitions in Aurora Edit

You use the Transition Tool to create and modify transitions.

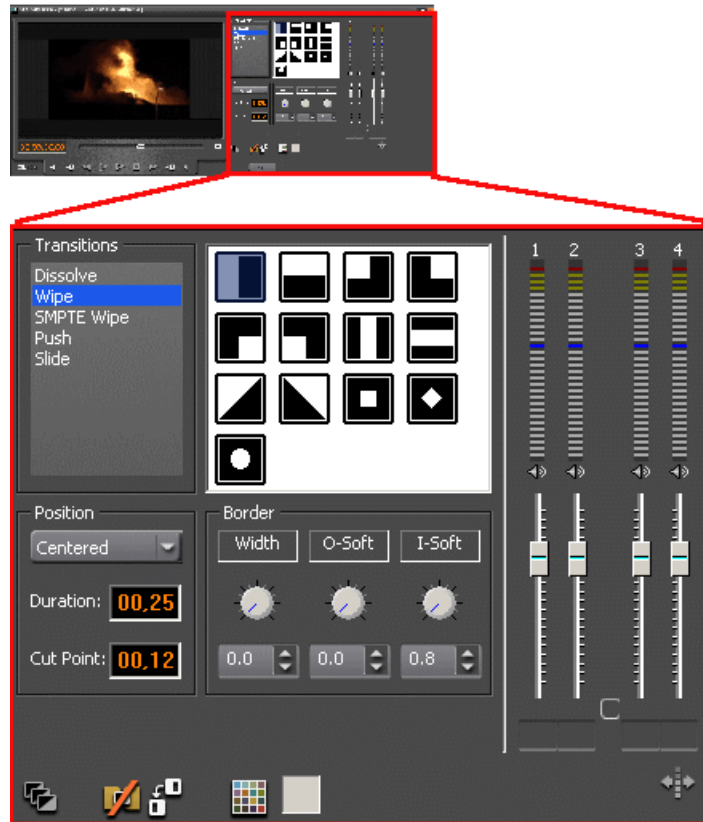

Understanding transition types

Aurora Edit has five types of transitions—dissolves, wipes, SMPTE wipes, pushes, and slides.

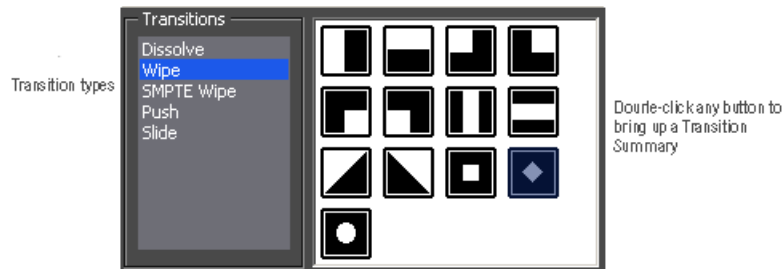

To bring up a Transition Summary window with a description of each transition, double-click an effect icon in the Transition Tool.

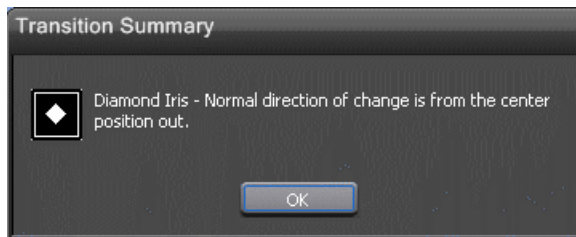

Dissolves



A dissolve fades the existing image as the new image becomes visible in its place. You cannot specify the direction or kind of dissolve.

You can create fades using the dissolve transition--to gradually fade the video in, place a dissolve transition at the beginning of a sequence; o fade the video off the screen, place a dissolve transition at the end of the sequence.

Wipes

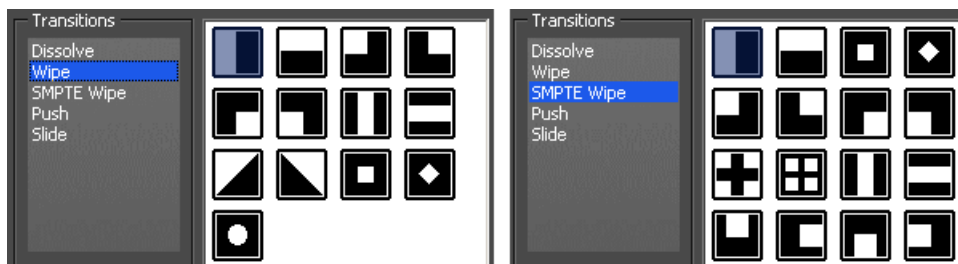

A wipe moves a new image over an old image. SMPTE wipes are industry standard wipe patterns, and include more complex directional wipes, shape wipes, clock wipes, and matrix wipes.

Pushes

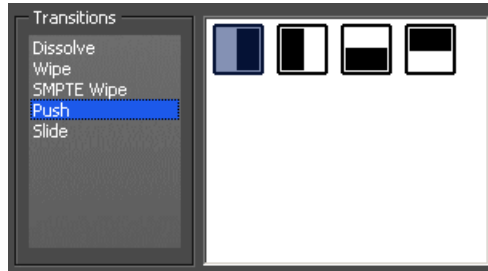

A push moves the second image in the direction chosen onto the screen, looking like the first image is “pushed” out of the way.

Slides



A slide moves either the old image or the new image. The old image moves to reveal the new image or the new image moves to conceal the old image.

A black arrow indicates the direction and path the second image takes moving into the frame. A white arrow indicates a reverse slide, where the first image slides to reveal the second image.

Creating a transition

Transitions are created between clips in your sequence, and are placed on the Timeline as an unrendered video effect.

You need to have handles on your clips in order to apply a transition.

To create a transition:

1. Press **5** on your keyboard or click the  **Transition Tool** button to select the Transition Tool.

The Transition window appears.

2. Click on the transition type and then on the icon for the effect you want.
3. Choose the **Position** of the transition:
 - Centered--Centers the transition across the cut point (default)

- End at Cut--Ends the transition at the cut point between clips
- Start at Cut--Starts the transition at the cut point between clips
- Custom--Sets the position by typing it in the Cut Point field. If you don't have enough handle material to complete the custom position you set, Aurora Edit completes as much of the positioning as it can.

4. Enter the **Duration** of the transition.

The default duration is 15 frames.

5. Move the mouse over the cut point between the two clips.

The cursor turns into a red X.

6. Click the mouse once to place the effect.

The transitions appears on the Timeline as a pink box with diagonal lines in it, indicating the transitions is unrendered.

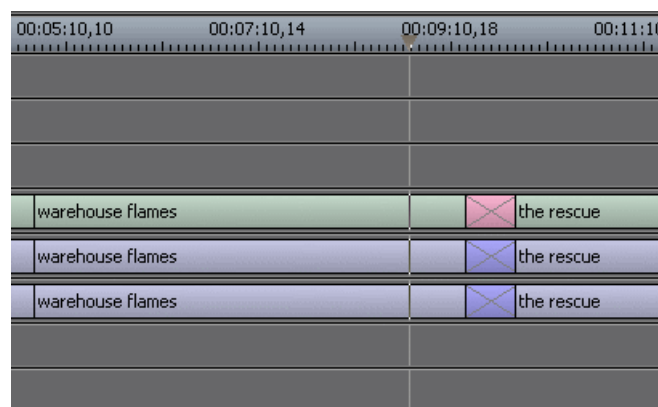

When you play the sequence in the Timeline, you see the transitions in the Video window.

Related Links

[Reversing a Wipe](#) on page 141

Changing transitions

You can change a transition from one type to another or change the properties of the transition.

1. Click once to select the transition on the Timeline.

You can select multiple transitions (by pressing **Ctrl +** clicking on each transition) and apply changes to all of the transitions at once.

A red and green dotted border appears around the transition indicating its properties are displayed in the Transition Tool. If you have more than one transition selected, the red and green dotted border appears only around the transition for which the properties are displayed.

2. Make any changes—type of transition, type of effect, transition position, duration, or border—using the Transition Tool.
3. Click **Apply**.

The new transition replaces the old one on the Timeline.

NOTE: *Double-clicking on a transition in the Timeline from any tool selects the Transition Tool and shows the transition's properties.*

Creating wipes

Adding a border to a wipe

With Aurora Edit, you can add a border to any wipe or SMPTE wipe.

To add a border, you adjust the border width and softness using the dials in the Transition Tool.



1. Use one of the following methods to adjust the wipe border:
 - Click on the dial you want to adjust and move it to the right to increase the value or to the left to decrease the value.
 - Type a value in the box below the dial.
 - Click the up and down spinners beside the value box.
 - To reset a dial to 0, double-click the dial.
2. Click **Apply**.

Related Links

[Wipe border parameters](#) on page 140

Wipe border parameters

You can adjust these border parameters:

Option	Definition	Range	Description
Width	Increases or decreases the size of the border.	0-100	0 is no border and 100 is the full border width available.
O-Soft	Softens the leading edge of the wipe.	0-100	0 is no softness and 100 is the full softness available for the outside region of the border.
I-Soft	Softens the trailing edge of the wipe.	0-100	0 is no softness and 100 is the full softness available for the inside region of the border.

Related Links

[Adding a border to a wipe](#) on page 140

Changing the border color of a Wipe

You can change the color of the wipe border to match a specific color scheme for your station or to provide more visual contrast in a clip.

The default color for a border is white. The Border color is only visible if the Border Width is set to a value greater than zero.

1. Click the  **Change Color** button on the Transition Tool.

The Color window appears.

2. Click on the new border color and click **OK**.

The box beside the Change Color button displays the new border color.

Reversing a Wipe

You can reverse the direction of a Wipe transition in your sequence.

1. Click the  **Reverse** button in the Transition Tool.
2. Create the transition.

Related Links

[Creating a transition](#) on page 138

Rendering transitions

A transition is placed on the Aurora Edit Timeline as an unrendered object, and must be rendered before the sequence can be sent to another destination.

You can render a transition anytime after creating it, and you can render a selected transition or all transitions in your sequence.

Select one of these methods for rendering:

- To render a single transition, double-click once in the Timeline to select the transition and click  **Render** on the Main Toolbar.
- To render all transitions, click  **Render All** on the Main Toolbar.

A window appears, showing the rendering progress.

Related Links

[Recording completed sequences to tape](#) on page 239

[Rendering video effects](#) on page 200

Creating transitions for an area of the sequence

You can create a transition on several cutpoints at once by defining an area of your sequence.

The type of transition you select applies to all cutpoints on all active tracks within the defined area. Applying transitions to a defined area of your sequence does not override any existing transitions you already have in your sequence; these transitions remain unchanged. By default, Aurora Edit applies the transitions to all active tracks on the Timeline; including the audio tracks, even if the Auto-Audio Crossfade button is off. If you want a transition to apply to the video tracks only, deselect all of the audio tracks in the sequence.

1. Define the area where you want to apply transitions with a Mark In and Mark Out point.
2. Define the transition you want to apply to all cutpoints within the marked area.
3. Click  **Transition All**.

Transitions appear at all cutpoints within the marked area.

Related Links

[Marking In and Out Points](#) on page 113

Deleting transitions

Sometimes you need to delete a transition on the Timeline.

1. Select the transitions to delete using one of these methods:
 - To delete one transition, click on the transition to select it.
 - To delete several transitions at once, hold down the **Ctrl** key on the keyboard, then click on each transition you need to delete.
2. Press **Delete** on the keyboard.

The transition disappears from the Timeline.

Audio crossfades

About audio crossfades

If you want to soften the transition between two audio clips, you can add an audio crossfade. Aurora Edit lets you create audio crossfades between any two edit points in your sequence. Apply crossfades to only the audio tracks in a clip or with each video transition you create.

Applying crossfades to the audio tracks only

You can apply the audio crossfade to just the audio tracks in your clip.

1. Press **5** on the keyboard or click the  **Transition Tool** button to select the Transition Tool.
2. Move the mouse over the cut point between the two audio clips where you want to place the transition.

The cursor turns into a red X.

3. Click the mouse once on the audio track to place the effect.

The audio crossfade appears on the Timeline as a blue box with an X in it. Audio crossfades do not have to be rendered.

Applying crossfades automatically with transitions

You can have Aurora Edit apply an audio crossfade each time you add a video transition effect between edit points.

1. Press **5** on the keyboard to select the Transition Tool.
2. Click the  **Auto-Apply Crossfade** button.

Each time you apply a video transition, an audio crossfade occurs on the audio tracks at the same point. The audio crossfade uses the same settings you are using for the video transitions; position, duration, and cut point.

You can also adjust the settings for the audio crossfade separately from the video transition if desired. Click to highlight the transitions for crossfading, whether all or some of the audio tracks.

Audio

This section contains the following topics:

- *Adjusting audio levels*
- *Monitoring audio tracks*
- *Setting Timeline audio settings*
- *Adjusting audio gain*
- *Using Audio Automation*
- *Adding audio narration*
- *Audio effects*
- *Enhancing audio using OMF files*

Adjusting audio levels

About adjusting audio levels in Aurora Edit

Aurora Edit allows you to adjust many aspects of the audio tracks in your sequence and add additional audio tracks to your sequence.

While Aurora Edit records up to eight audio tracks, you can edit up to 16 tracks.

Using the Audio Mixer Tool, you can adjust levels and pan controls for individual tracks in a sequence or for entire clips. You adjust the audio levels within a clip by adding and manipulating fade control points in the Timeline, which is known as rubber banding. You can also view the audio waveform for a sequence, providing a visual indication of audio levels.

You can also connect an external mixer to Aurora Edit for further adjustments.

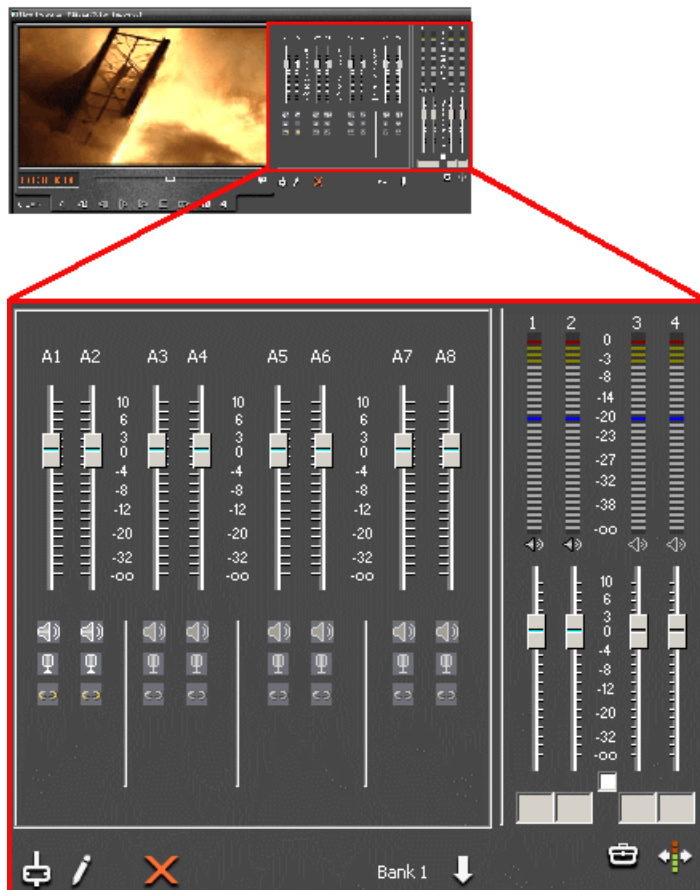

Viewing audio levels on the Timeline

You can view audio levels in Aurora Edit on the Timeline in a variety of ways.



- In the Audio Mixer Tool, the fade control line is always visible whether the audio track is expanded or not.



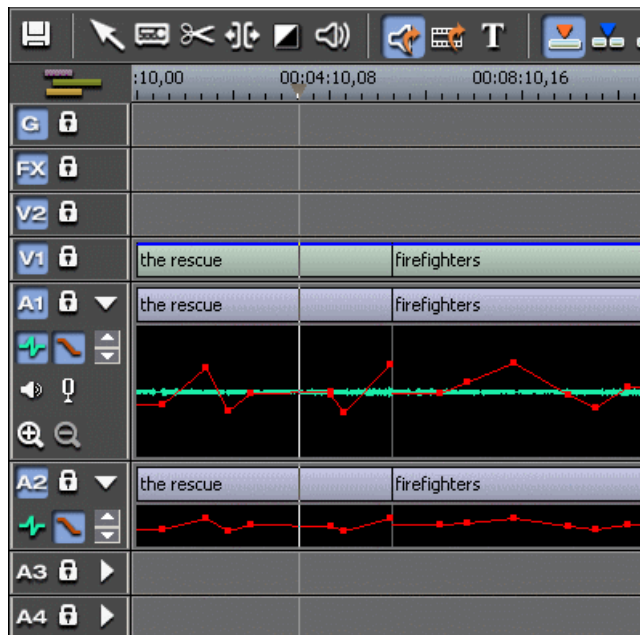

- In each of the Aurora Edit tools, you can view audio levels at any time by clicking the  **Expand Track** button next to the audio track you want to view.

The audio tracks will appear as shown below.



- Click  **Show Audio Fade Control Points** to show the points anytime the audio track is expanded.
- Click  **Show Audio Waveform** to show the waveform for the sequence in the expanded track.
- Click the up arrow on the  **Change Track Height** button to shrink the track height or click the down arrow to expand the height of the track.

- Click  **Mute** to mute the selected audio channel or  **Solo** to mute all other audio channels except the selected track.
- Use the  **Zoom In Waveform Vertically** or **Zoom Out Waveform Vertically** buttons to zoom in and out vertically on the expanded audio waveform.

Changing audio levels in a clip

You change audio levels by manipulating the fade control line on the audio track.

1. Expand the audio track to reveal the fade control line.
2. To adjust the audio level in a clip, do one of the following:
 - To adjust a specific point in a clip, click on the red line to create a fade control point. Using the fade control point as a pivot, click on another point in the audio track and drag the red line to raise or lower the level.
 - To raise the sound level for the entire track in a clip, click the fade control line and drag it up in the track. If fade control points exist, you need to click on a point before raising the level.
 - To lower the sound level, click the fade control line and drag it down.
 - To raise or lower the sound level for the entire track in a clip while preserving the positions of the existing fade control points, press the **ALT** key, click one of the fade control points, and while holding down the left mouse button, drag the fade control point up or down. Release the mouse button while still holding the **ALT** key.

If your audio levels are still too low or too high after adjusting the fade control line to its maximum or minimum value, you can make further adjustments by changing the audio gain.

Related Links

[Adjusting audio gain](#) on page 152

Removing fade control points

Fade control points allow you to manipulate audio levels in Aurora Edit and can be removed if needed.

Use one of these methods:

- To remove one fade control point, press **Ctrl + click** on the fade control point. Notice that the cursor changes to a red hand, allowing you to click and remove the control point.
- To remove all of the fade control points, right-click within the audio clip and select **Clear Fade Control Points**.

- To remove an area of fade control points, set a Mark In and Mark Out point to indicate the area to be removed, right-click on the audio track and select **Clear Fade Control Points Area**.

Ganging and adjusting multiple audio tracks

You can gang sets of audio tracks if you want to adjust multiple audio tracks simultaneously.

1. In the Audio Mixer Tool, check the  **Gang** button for each track you want to adjust.
2. Move the slider up or down to set the track volumes.



Monitoring audio tracks

Soloing an audio track

When you Solo a track, all other audio tracks mute until you turn off the Solo feature.

By default, Aurora Edit monitors all audio tracks in a sequence. However, you can specify the tracks to monitor using the Solo button. You can also Solo multiple tracks if you wish.

Solo audio tracks using one of these methods:

- In the Audio Mixer Tool, click the  **Solo** button for each audio track you want to solo.
- In the Timeline, click  **Expand Track** in the audio track you want to solo, then click the  **Solo** button.

When you activate Solo in one of these tools, the button gets activated automatically in the other tool.



To turn off Soloing, click each  **Solo** button again.

Muting an audio track

When you Mute one or more tracks you hear only the unmuted tracks until you deactivate Muting. Muting is the opposite of Soloing.

By default, Aurora Edit monitors all audio tracks in a sequence. However, you can specify the tracks to monitor using the Mute button. Muting is useful when recording voice-overs to the Timeline.

Mute audio tracks using one of these methods:

- In the Audio Mixer Tool, click the  **Mute** button for each audio track you want to mute.
- In the Timeline, click the  **Expand Track** button in the audio track you want to mute, then click the  **Mute** button.

When you activate Mute in one of these tools, the button gets activated automatically in the other tool.

To turn off muting, click each  **Mute** button again.

Using the Master Audio Sliders to set output level

You use the Master Audio Sliders to adjust the output level for your final sequence.

When you output audio, the 16 audio tracks are mixed down to four or fewer tracks. The pan direction determines how tracks are mixed. By default, odd-numbered tracks mix to channel one and even-numbered tracks mix to channel two of your output sequence.

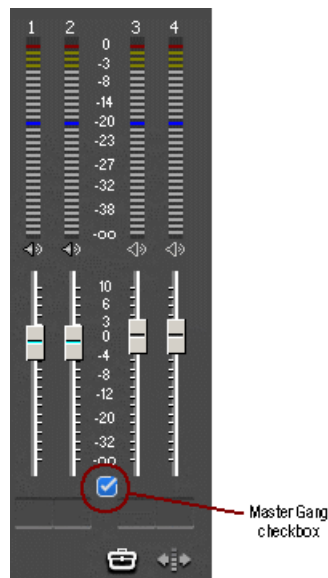

1. If you want to adjust pairs of channels simultaneously, check the **Master Gang** checkbox.

If all audio channels are not visible, click  **Expand Channels**.

2. Drag the level slider up or down for each pair of channels to set the output volume.

Setting Timeline audio settings

You determine the pan control and channel routing for each track of the timeline using the Timeline audio settings.

Setting the pan control adjusts the sound location for your sequence. You can select where the audio tracks of your sequence output by specifying the number of output channels and routing those channels.

1. In the Audio Mixer Tool, click the  **Settings** button to bring up the Timeline Audio Settings controls.

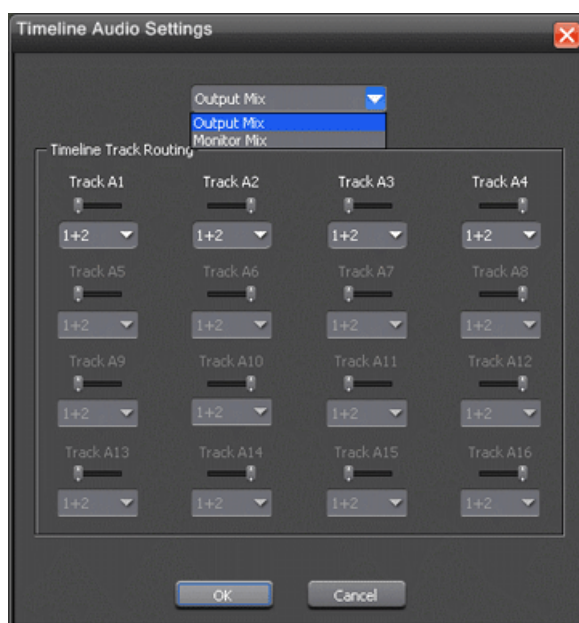

2. Select **Monitor Mix** or **Output Mix** from the pulldown.

Monitor Mix controls the panning and channel output for the speakers in the edit bay, and does not affect sends to the server, play to tape, or live playback through the Playback Channel.

Output Mix controls the panning and channel output for the actual output of your sequence for playback.

3. Set the pan control by dragging the pan slider for an audio channel to the right or left position; press **Alt + click** on a pan slider to set the pan direction to center.

By default, odd-numbered channels pan to the left and even-numbers channels pan to the right. Changing the pan direction affects the entire track in a sequence.

4. Route audio channels by selecting the channels you want to output: **1+2**, **3+4**, etc. or **All**.

For a two-channel system, audio channels route by default as follows:

If the pan control is in this position...	Audio output routes to...
Left	Channel 1
Right	Channel 2
Center	All channels

If you have more than eight audio tracks in your sequence, click the  **Bank Select** arrow to move to Bank 2 and then make your changes for the additional tracks.

Adjusting audio gain

Adjust the audio gain to adjust the audio levels within a clip in your sequence.

Audio may record in at levels that are too low or too high. The Audio Gain feature lets you compensate by adjusting the clip. You can adjust the audio between -41 dB and +10 dB. To adjust an audio clip, you can use the Timeline Tool, the Trim Tool, or the Audio Mixer Tool.

1. Select the clip you need to adjust.
2. Right-click in the appropriate audio track and choose **Adjust Audio Gain**.

The Adjust Audio Gain dialog box appears.

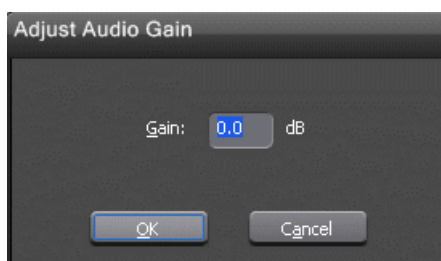

3. Enter a new value for the audio gain:
 - To lower the gain, enter a value preceded by a minus sign, such as -5.
 - To raise the gain, enter a value, such as 5.
4. Click **OK**.



The new value appears for the audio clip.

Related Links

[Changing audio levels in a clip](#) on page 148

Using Audio Automation

You use Audio Automation to adjust volume on the fly while a sequence is playing.

1. Press **6** on the keyboard or click the  **Audio Mixer Tool** button in the Timeline toolbar.
2. Click the  **Write Audio Automation** button.
3. Click in the Timeline where you want the audio automation to start.
4. Press the **spacebar** or click **Play** to play the sequence.
5. As the sequence is playing, click on the audio slider in the appropriate channel and raise or lower it.
6. When you reach the end of the sequence, press the **spacebar** to stop.

The automation appears as fade control points in the audio tracks.

If you need to, you can go back to adjust the fade control points for each level.

Showing Audio Automation

When you play a sequence with Audio Automation, you may want to see the audio sliders moving along with the video, which show you the audio changes you made while recording.

If you play a sequence without Show Audio Automation on, you see the fade control points from the automation, but the sliders don't move during playback.

- Verify that the  **Show Audio Automation** button is activated in the Audio Mixer Tool.

When you play the sequence, the sliders move along with it.

If you need to do any fine-tuning, you can move any of the fade control points once the sequence has stopped playing.

Removing Audio Automation

You can remove an individual fade control point or all points in a sequence.

Use one of these methods to remove audio automation:





- To remove a single fade control point, press **Ctrl + click** until the cursor changes to a red hand, then click and remove the control point.
- To remove all fade control points, click  **Clear Audio Automation**.

Adding audio narration

With Aurora Edit, you can record and insert narration in your sequences by recording directly to the Timeline.

Before you can record a narration, you need to create a microphone source in Aurora Edit. For instructions on creating a microphone source, see the Aurora Edit Installation and Configuration Guide.

If you've enabled Loop Tones, a tone will sound at the end of each microphone recording. When the loop tones are done playing, the record starts again automatically. You can use loop tones for voiceovers directly to the Timeline in case you make a mistake and need to re-record.

1. Open the sequence where you want to add the narration.
2. Select the Source Tool by pressing **2** on your keyboard or clicking the  **Source Tool** button in the Timeline Toolbar.
3. If necessary, adjust the input levels to prevent overload at the input stage of the source microphone.
4. Mark an In and Out point in your sequence where you want the voiceover to record.
5. If you want to continually record over the same point until you are satisfied with the performance, click the  **Loop Record** button to enable it.
6. If you want the system to display the remaining duration of the record, press the  **Record Countdown** button.
7. To start recording, press **F12** on your keyboard or click the  **Start Recording** button.
8. To stop recording, press the **spacebar** on your keyboard or click the  **Stop Recording** button.

Related Links

[Adding video sources](#)

[Add Source—Connections settings](#)

Audio effects

About audio effects

Aurora Edit lets you create audio effects in your sequence by adjusting the audio EQ in a clip, adjusting or disguising a voice.

You can adjust the Playback EQ of a clip that has already been recorded or the input EQ of a live source. You can also disguise a voice to go along with a blur or mosaic video effect, which disguises the face of an individual.

You use the Audio Effects Tool in Aurora Edit to create these effects.

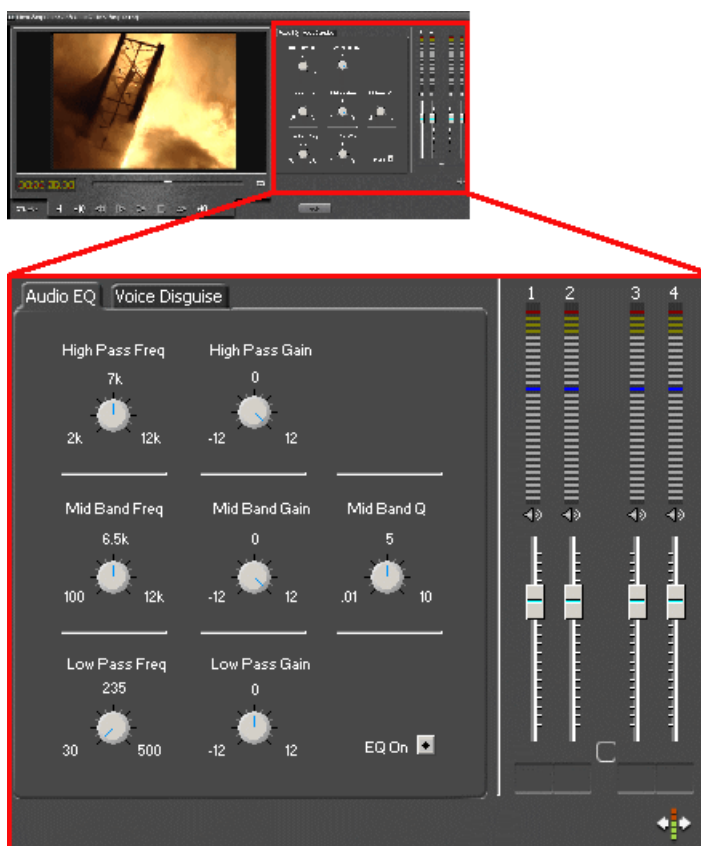

Equalizing audio in a recorded sequence

Using the Audio EQ tab in the Audio Effects Tool, you can boost or cut the low-end audio, adjust the mid range audio, and modify the high-end shelf.

You can adjust the Audio EQ on a single clip or multiple clips in a sequence.

The Aurora Edit Audio EQ is a 3-band parametric EQ, consisting of a low-pass filter, a mid-band pass with a variable Q, and a high-pass filter. When disguising a voice, adjusting the Audio EQ on a clip in addition greatly enhances the effect.

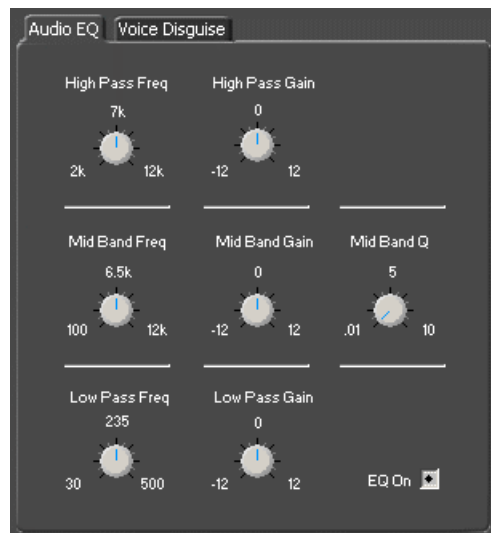

Sequences with 5 or more audio tracks cannot play both playback and live EQ at the same time. During an edit, any unrendered EQ will not be heard to allow for input EQ.

1. Press **7** on your keyboard or click the  **Audio Effects Tool** button.
2. Select the clip you want to adjust. To select multiple clips, hold down the **Ctrl** key while clicking on clips.

The EQ turns on automatically and the button turns red.

3. Adjust the High, Mid, and Low frequencies as needed by adjusting the dials.

You can double-click any dial to reset the default value.

4. Play back the clip to hear your changes.

While you are playing a clip, you can toggle the EQ button on and off to compare the original and adjusted clips.

5. Make further adjustments as necessary.
6. Click **Apply** to apply your changes.

While you can hear the changes when you play back the clip, you need to render the effect before you can send it to another workstation or editor. If you don't render the effect, Aurora Edit automatically renders before sending.

Related Links

[Using a previously applied Audio EQ effect](#) on page 157

Audio EQ parameters

The audio equalizer is a 3-band parametric EQ, consisting of a low-pass filter, a mid-band pass with a variable Q and a high-pass filter.

Frequency parameters

The Frequency dials let you adjust the frequency of the three shelves.

Dial	Range	Default
High Pass Frequency	2k Hz to 12k Hz, +/- 12 dB	7k Hz
Mid Band Frequency	100 Hz to 12k Hz, +/- 12 dB	6.5k Hz
Low Pass Frequency	30 Hz to 500 Hz, +/- 12 dB	235 Hz

Gain parameters

The Gain dials let you alter the gains of the three shelves.

Dial	Range	Default
High Pass Gain	-12 to +12 dB	0
Mid Band Gain	-12 to +12 dB	0
Low Pass Gain	-12 to +12 dB	0

Mid Band Q parameters

The Mid Band Q lets you alter the octave range for both the Mid Band Frequency and the Mid Band Gain.

The range for the Mid Band Q is .01 to 10, with 5 as the default.

Using a previously applied Audio EQ effect

You can apply a previously applied Audio EQ effect to other clips in the same Timeline.

1. Select the unrendered clip.
2. **Ctrl + click** the audio clips you want to affect.
3. Select **Apply**.

Related Links

[Equalizing audio in a recorded sequence](#) on page 155

Disguising a voice in a clip

Using the Voice Disguise tab on the Audio Effects Tool, you can distort a clip's audio using the Pitch Adjustment and Randomizer parameters.

Voice Disguise is not a real-time effect; Aurora Edit automatically renders the voice disguise when you apply the effect to a clip.

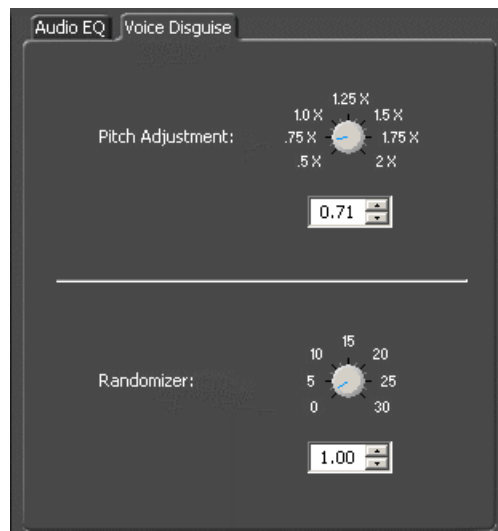

1. Press **7** on your keyboard or click the  **Audio Effects Tool** button.
2. Click the Voice Disguise tab to bring it to the front of the window.
3. Select the clip you want to disguise.

To select multiple clips, hold down the **Ctrl** key while clicking on clips.

4. Adjust the pitch and use the randomizer as necessary.
5. Click **Apply** to apply your changes.

The voice disguise adds to your clip, and a new master clip is created and saved to the Rendered Clips bin.

Pitch Adjustment and Randomizer parameters

When you adjust pitch you also adjust the tone of a voice. Adjusting the pitch less than 1x makes the audio sound slower and lower. Adjusting the pitch greater than 1x makes the audio sound faster and higher. A lower pitch is typical for a blur or mosaic video disguise.

You also can apply the Randomizer along with the Pitch Adjustment. The Randomizer periodically alters the Pitch Adjustment in order to further skew the audio, therefore better disguising the voice.

Dial	Range	Default
Pitch Adjustment	.5x to 2x	1x
Randomizer	0 to 30	0

Enhancing audio using OMF files

With Aurora Edit, you can add enhanced audio to your sequences using an audio post-production tool.

This is accomplished by exporting an Aurora Edit sequence as an OMF file, which strips out the video tracks and exports only the audio tracks. The resulting OMF file can be imported into a post-production tool, where you can enhance the audio, then export the audio tracks as an OMF file which can be re-imported into Aurora Edit and used in the original sequence.

Aurora Edit supports these audio post-production tools:

- Digidesign Pro Tools LE, version 6.7 and higher
- Fairlight systems (using the AVTransfer utility available from avtransfer.net)
- Steinberg Nuendo, version 2.0 and higher

Related Links

[Importing EDL files](#) on page 82

[Exporting EDLs](#) on page 245

Exporting an Aurora Edit sequence as an OMF file

If you are using a post-production tool to enhance the audio in your sequence, you first need to export your Aurora Edit sequence as an OMF file.

1. In the Aurora Edit Bin, select the sequence that you wish to export.
2. Select **File | Export | EDL**.
3. Select **Audio OMF Files** as the Save as Type.
4. Navigate to the folder that will be the destination for the exported file.
5. Click **Options** and select your export options:

Setting	Option	Description
Media Options	Consolidated Media	Exports the portion of each clip that appears on the Timeline, with the export handle length included. This option has a faster transfer time. This is the default setting.
	Full Media	Each clip is exported in its entirety, including footage that has been trimmed. This option requires a longer transfer time, but provides you with extra handle material.

Setting	Option	Description
Compatibility	Pro Tools	Select which post-production audio tool you are using. NOTE: If you select Pro Tools, the filename may be truncated, as Pro Tools only supports filenames with 31 characters or less.
	Nuendo	
	Fairlight	

NOTE: *You only need to select export options once; selected settings are saved and applied to subsequent files.*

- Click **OK** in the Export Options window, then click **Save**.

Enhancing audio with Digidesign Pro Tools

You can use Digidesign Pro Tools, version 6.7 and higher, to enhance the audio in your Aurora Edit sequences.

- Open the Pro Tools application.
- Create a new session with these settings:

Session Parameter	Selection
Audio File Type	BWF (.WAV)
Sample Rate	48 kHz
Bit Depth	16 Bit

- Select **File | Import Session Data**.
- Select the OMF file that you exported from Aurora Edit and click **Open**.
- In the Import Session Data window, choose these settings:

Option	Selection
Convert clip-based gain to automation	
Ignore keyframe gain	Off

- Click **OK**.
- Make your audio enhancements.
- Select **File | Export selected tracks as OMF/AAF**.
- In the Export to OMF/AAF window, choose these settings:

Option	Selection
Export as	OMF
Target project timecode format	NTSC: 29.97 Drop or Non-Drop PAL: 25
Quantize edits to frame boundaries	Off
Apply SRC	On
Source sample rate	48000
Destination sample rate	48000
Audio format	Embedded
Audio bit depth	16
Source media type	Select Copy from source media or Consolidate from source media
Other settings based on user preference	

10. Click **OK**.
11. In the Publishing Options window, name your sequence and click **OK**.
12. Select the desired folder for export, type a name for the exported file, and click **Save**.

You can now import your enhanced OMF files back into Aurora Edit.

Enhancing audio with Steinberg Nuendo

You can use Steinberg Nuendo, version 2.0 and higher, to enhance the audio in your Aurora Edit sequences.

Please note that Nuendo doesn't support fade control points.

1. Open the Nuendo application.
2. In order to work properly with Aurora Edit files, make sure Project Setup settings are as follows:

Option	Selection	Nuendo Version	
		2.0	3.0 and higher
Frame Rate	NTSC: 29.97 fps or dfps PAL: 25 fps	4	4
Sample Rate	48.000 Hz	4	4
Record Format	16 Bit	4	4

Option	Selection	Nuendo Version	
		2.0	3.0 and higher
Record File Type	Wave File	N/A	4
Other settings based on user preference		4	4

3. Select **File | Import | OMF**.
4. Select the name of the file to import and click **Open**.
5. For versions 3.0 and higher, in the Import Options window, select these options and click **OK**:
 - **Select All Tracks**
 - **Import All Media Files**
 - **Import Clip Gain as Automation**
6. Make your audio enhancements.
7. Select **File | Export | OMF**.
8. In the resulting window (OMF Export Setup for version 2.0, Export Options for versions 3.0 and higher), choose these settings:

Option	Selection	Nuendo Version	
		2.0	3.0
Select All		N/A	4
OMF Version	2.0 File	4	4
Export All to One File	On	4	4
Export Clip Based Volume	On	4	4
Use Fade Curves	On	4	4
Export Clip Names	On	N/A	4
Export Sample Size	16 Bit	4	4
Export Sample Rate	48,000	4	N/A
Other settings based on user preference		4	4

9. Click **OK**.
10. Navigate to the folder where you want to save, name the file and click **Save**.

You can now import your enhanced OMF files back into Aurora Edit.

Enhancing audio with Fairlight and AVTransfer

You can use Fairlight systems, with the AVTransfer utility, to enhance the audio in your Aurora Edit sequences

1. Open AVTransfer.
2. Click **Open omf Project**.
3. Browse and select the OMF file that you exported from Edit and click **Open**.
4. In the OMF Import Options window, leave settings at their default values and click **OK**.
5. In the Explorer window, select the name of the file in the Project Data area, click **Export Project as Fairlight ML4**.
6. Browse to where you want to save the file, and click **Save**.
7. In the ML Export Options window, choose these settings and click **OK**:

Option	Selection
Bit Depth Conversion	16 bit
Export Sound Type	Wav
Sample Rate Conversion	Resample @ 48000
Other settings based on user preference	

8. Open the .ML file in Fairlight, make any audio enhancements, and save the file as ML4.
9. From the home screen in AVTransfer, click **ML3/ML4**.
10. Browse to locate the Fairlight exported file and click **Open**.
11. In the Explorer window, select the name of the file in the Project Data area and click **Export Project as OMF**.
12. Browse to where you want to save the file, rename the file if necessary, and click **Save**.
13. In the OMF Export Properties window, use one of these methods to set OMF properties:
 - If you are using AVTransfer version 4.0 revA17 or later, press the **Grass Valley Presets** button and click **OK**.
 - If you are using an earlier version of AVTransfer, manually select the OMF Export options as follows, and click **OK**:

Option	Selection
Omf Version	2.x
EDL Edit Resolution	Audio Sample
Data Format	WAVE

Option	Selection
Bit Depth Conversion	16 bit
Effects	Preserve clip gain
Export Composition Options	One OMF file (audio embedded)
Export Media Options	All audio
Sample Rate Conversion	Resample @ 48000
Other settings based on user preference	

NOTE: *The following presets are also compatible with Aurora Edit: Avid MC, Ensoniq Paris, Pro Tools (Digitranslator), Pro Tools (Omftool).*

You can now import your enhanced OMF files back into Aurora Edit.

Importing enhanced OMF files back into Aurora Edit

Once you've enhanced the audio tracks, you can import them back into the original Aurora Edit sequence.

1. In Aurora Edit, select **File | Import | EDL**.
2. Select the OMF file that you exported from Pro Tools, Nuendo, or AVTransfer and click **Open**.

The OMF file imports into the Aurora Edit Bin as a sub-bin with the name of the Aurora Edit sequence; within that bin are a sequence and its audio files.

3. Open the sequence in the imported Bin folder.
4. Copy the enhanced audio tracks into the original Aurora Edit sequence as follows:
 - a) Make sure all necessary tracks are active.
 - b) In the enhanced audio sequence, select all tracks to copy, right-click and select **Copy Selected**.

Press **Shift + S** to select all tracks at once.

- c) Open the original Aurora Edit sequence, place the cursor where you want to audio files to go, right-click and select **Paste**.

You can also drag the enhanced sequence directly from the Bin into the original Aurora Edit sequence.

The text on the clip names turns blue to indicate that the video and audio tracks are now unlinked.

5. If you want to re-link clips, select all tracks for each clip then select **Link** from the right-click menu.
6. Save the file.

Chapter 10

Advanced editing

This section contains the following topics:

- *Converting clip aspect ratios*
- *Inserting filler between clips*
- *Creating a Fit To Fill*
- *Adding a freeze frame to your sequence*
- *Varying the speed of a clip*
- *Creating split edits*
- *Using control track*
- *Using Match Frame*
- *Editing using offline proxy media*
- *Linking video MOS objects to the Timeline*
- *About Aurora Edit and Final Cut Pro*

Converting clip aspect ratios

About aspect ratio conversion

Aurora Edit lets you modify aspect ratio settings in real-time with standard or custom templates.

When Aurora Edit is initially configured, a default aspect ratio, 4:3 or 16:9, is set through the Options menu. As clips are brought into the Source Tool, Aurora Edit automatically converts those that have a different aspect ratio than the default setting.





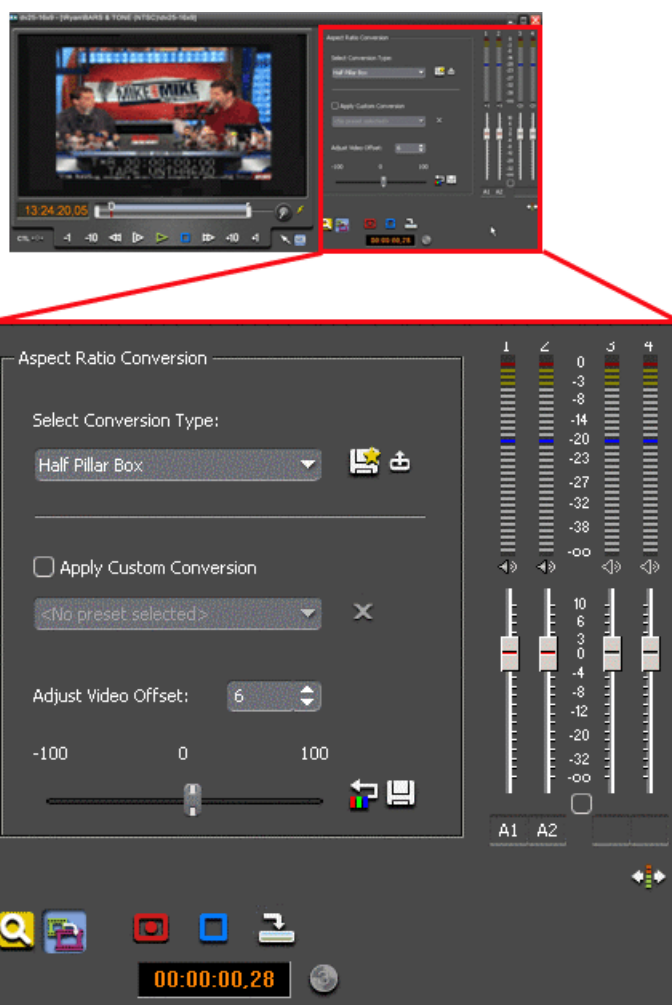

Aurora Edit uses a default conversion type, letter box, when down converting from 16:9 to 4:3, and pillar box when up converting from 4:3 to 16:9.

Using the Aspect Ratio Conversion tool, accessed from the Source Tool, you can manually convert the clip if you wish to use another conversion method to produce a different video image. You can also create preset aspect ratio conversion settings.

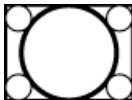
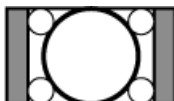

Aspect ratio conversion types

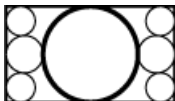
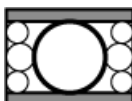
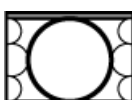
Aurora Edit has 8 different conversion types, 4 for up converting to a 16:9 aspect ratio, and 4 for down converting to a 4:3 aspect ratio.

Source clip	Conversion type		Offset choices
4:3 up converting to 16:9 	Pillar Box (default)		None
	Half Pillar Box		-100 to +100
	Zoom		None
	Stretch		-100 to +100
16:9 down converting to 4:3 	Letter Box (default)		None
	Half Letter Box		-100 to +100
	Crop		-100 to +100
	Compress		None

Manually converting a clip aspect ratio

If the video doesn't look acceptable after Aurora Edit converted the aspect ratio using the default settings, you can change the conversion method to produce better results.

1. Load the clip into the Source Tool.
2. Click the  **Aspect Ratio Conversion** button.
3. Select the conversion type from the drop-down list or select a preset.



4. Play the clip to view how the aspect ratio converted the clip.
5. Modify the conversion with the **Adjust Video Offset** controls if necessary (only Zoom and Half Pillar Box in the drop-down list can be modified).

If you want these new conversion settings to be applied to each new clip that comes in as a clip source, click the  **Save as Default** button.

6. If the conversion type you have saved as the default does not appear as the first choice in the list when you open the Aspect Ratio Conversion tool, select the  **Load Default** button to bring up the saved conversion type.
7. Copy the clip to the Timeline.

Creating an aspect ratio preset

You can create custom presets for aspect ratio conversion settings you use frequently.

1. In the Source Tool, click the  **Aspect Ratio Conversion** button.
2. Select the Conversion Type from the drop-down list.
3. Modify the Video Offset, if desired.
4. Click the  **Save Preset** button.
5. Type a name for the preset and click **OK**.

You can now select this preset and apply it to other clips.

If you need to remove a preset from the drop-down list, select the preset and click  **Delete Preset**.

When a preset Aspect Ratio setting is recalled and the user makes further changes to the offset, they may save this as a new preset or they can select the offset  **Reset** button which will the offset back to the original setting for the selected preset.

Inserting filler between clips

With Aurora Edit, you use filler to place a gap between two shots or to create a dip to silence in the sequence.

You can also use filler to serve as a placeholder for late-arriving material. Inserting filler is both track and edit mode specific.

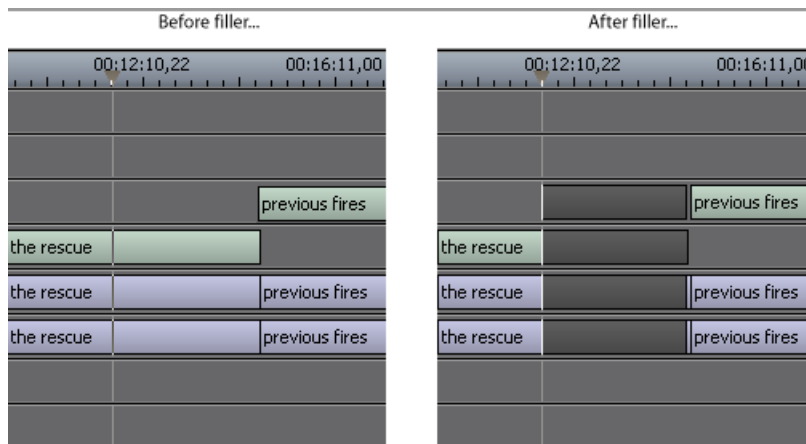

1. Press **1** on your keyboard to choose the Timeline Tool.
2. Click once on the clip at the filler start point.
3. Right-click and select **Insert Filler**.

The Filler Properties window appears.

4. Enter a Duration for the filler and click **OK**.

The Timeline updates with the filler inserted into the sequence.



You can also insert filler between Mark In and Mark Out points on all tracks that are active. You cannot add a transition effect between a clip and filler.

Creating a Fit To Fill

You can create a Fit To Fill between sequence clips. When you use Fit To Fill, Aurora Edit compares the marked source clip's duration to the target duration you mark in the Timeline and adjusts the clip speed to match the target duration.

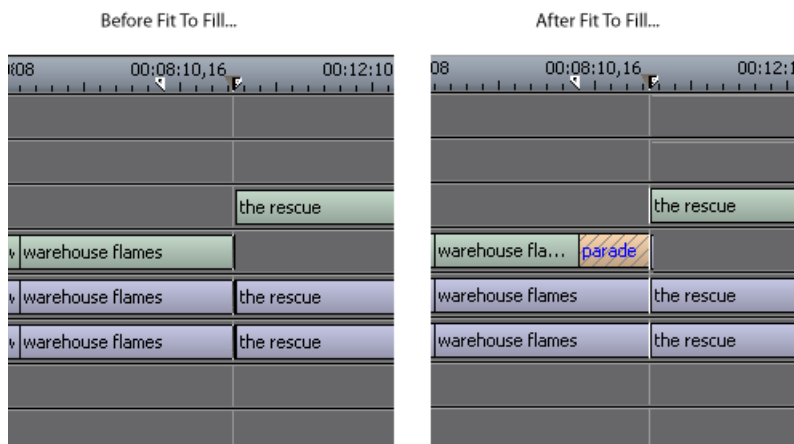
Fit To Fill only works with a clip that already exists in your Bin.



1. Press **9** on the keyboard or click the  **Fit to Fill** button in the Timeline toolbar.
2. Mark In and Out points in the Timeline for the area to be filled:
 - To Mark an In point, move the cursor to the desired clip beginning and press **I** on the keyboard.
 - To Mark an Out point, move the cursor to the desired clip end and press **O** on the keyboard.
3. In the Bin, double-click on the clip you are using for the fill.
4. Mark the selection you want to use by marking an In and Out point.
5. Press **C** on the keyboard or click the  **Copy to Timeline** button.

A new clip appears in the Timeline covering the space indicated.
6. Click **Cancel** to close the Bin Trimmer window.
7. Clear the Mark In and Mark Out points for the new clip by pressing **P** and **[** on the keyboard.
8. Play the sequence to determine if the Fit to Fill works in your sequence.
9. Turn off Fit To Fill mode.

If you have a clip in the Bin that's trimmed the way you want it, you can drag it to the Timeline while in Fit To Fill mode to automatically fill the area between the Mark In and Mark Out points. You can also create a freeze frame by setting the In and Out points to the same position.

Adding a freeze frame to your sequence

You can create a freeze frame to use in a sequence; you might typically use a freeze frame at the end of a clip to hold the image.

1. Select a clip.
2. Move the cursor to the frame you want to freeze.
3. Press **M** on the keyboard or right-click and choose **Match Frame to Bin**.

The viewing monitor displays the frame from the source.

4. Mark an In point where you want the frame to occur.
5. Click  **Enable variable speed controls** and select **0**.
6. Press **F12** to start recording.
7. Press the **spacebar** to stop recording when you have enough media.

The freeze frame appears as a new clip with an unrendered image.

You can also create a freeze frame by setting the play speed of a clip already on the Timeline to zero. The system uses the Mark In point as the freeze frame.

Related Links

[Using Match Frame](#) on page 172

Varying the speed of a clip

You can vary the clip speed to create slow or fast motion effects in a sequence.

1. Click once on the clip you want to change.
2. Right-click on the video track for the clip and choose **Play Speed**.

The Change Playback Speed window appears.

3. Enter a new speed percentage for the clip.
4. To keep the clip duration constant, check the **Maintain Duration** checkbox.
5. Click **OK**.

The play speed of the clip changes.

To check a clip's play speed, right-click on the clip and choose **Play Speed**.

Creating split edits

The Cut Point Edit Tool provides a way to create split edits, which allow you to trim one track without affecting other tracks.

Split edits are useful if you want to have the audio track start before the video track or extend past the video.

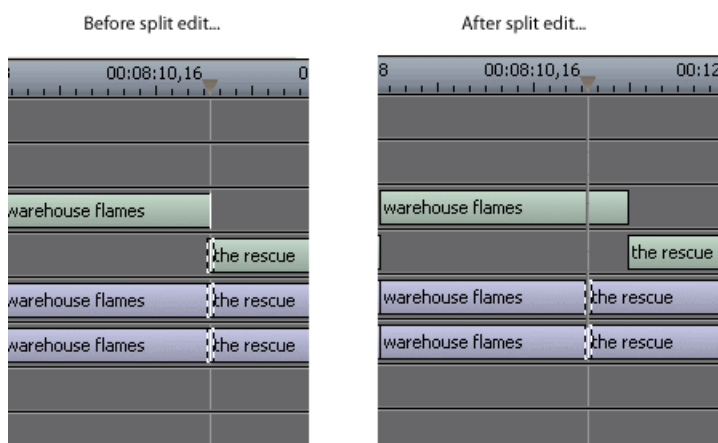

1. Select the Cut Point Edit Tool by pressing **4** on the keyboard or clicking the  **Cut Point Edit Tool** button.
2. Deselect any tracks you don't want to split off.

To deselect a track, click once in the track indicator on the Timeline. For example, to split off the video track, deselect the audio tracks.

3. Click the  **Trim Both** button.
4. Trim the cut points.

The Timeline updates to reflect the split.

Related Links

[Changing cut points](#) on page 129

Using control track

Control track lets you see the actual count of a clip or piece of tape instead of using timecode. Control track is available in the Timeline and Source Tools.

1. Click the  **Control Track** button.

The timecode field changes and the text becomes yellow.

2. To switch back to viewing the timecode, click  **Control Track** again.

To reset the control track to zero, click the  **Reset Control Track** button while in Control Track mode.

Using Match Frame

Aurora Edit can match frames on the Timeline with the input source. Use Match Frame if you need to add more material at the beginning or end of a clip. You can Match Frame to either the Bin or Source.

Related Links

[Adding a freeze frame to your sequence](#) on page 170

Match Frame to Bin

Match Frame to Bin finds a frame you select from the Timeline and loads it in as a clip source.

1. Select a clip on the Timeline.
2. Select the frame you want to match.
3. Press **M** on the keyboard.

Aurora Edit finds the frame on the clip and loads it as a clip source.

Match Frame to source

Match Frame to Source finds a frame you select from a Timeline import source and loads it into the Source Tool, using that frame as the Mark In point.

1. Select a clip on the Timeline.
2. Select the frame you want to match.
3. Press **Shift + F4** on the keyboard.

Aurora Edit finds the frame on the source and loads it into the Source Tool as a new Mark In point.

4. To view the frame source, press **F7**.



To use this footage in a clip, press **F12** to record to the Timeline.

Editing using offline proxy media



Aurora Edit and Aurora Edit LD can preview and edit with proxy media that is associated with offline archived hi-resolution video.

This feature allows editors to use archived offline assets within a Timeline as if they were present in the online news database. The offline assets become available in the bin by doing a MediaFrame search. Finding offline assets can be accomplished by setting up filters in the Aurora search tool or by searching for a known archived asset. Once the search is done, the asset search results are placed in the Aurora Edit or Aurora Edit LD bin and become available as editable material on the Timeline.

The offline assets found in the database search will be indicated by an orange dot in the search result bin view. An offline clip can be then be loaded into the clip player, and saved to the Timeline. Any number of archived clips can be used and can also be mixed with online clips on the Timeline. The video can be edited in the same manner as online video using the Timeline tools.

Once a story is complete, the editor can restore the sequence (they must have restore rights) with the  **Restore Sequence Assets** button, synchronize the video (replace the lo-res video with hi-res) with the  **Synchronized Restored Assets** button, and the sequence is ready to playout.

Once the story has been sent to playout, the editor has the option to unlink the online assets with the  **Unlink Online Assets** button and return the restored offline clips on the Timeline to proxy references. This allows them to delete the hi-res video restored media and preserve the Timeline for preview or future restores.

NOTE: Both the Restore and Unlink functions are undoable items. In other words, you can use the Timeline  Undo button to undo the restore or unlink action and also use the  Redo button to redo the actions.

Seaching for Offline Assets

To search for archived, unrestored offline assets to use within a Timeline, use the MediaFrame search tool. Archived, unrestored offline assets can be added to the Timeline, edited, restored, and sent to payout.

1. Open a new sequence from the Bin Contents using the  **New Sequence** button, name the sequence and select **OK**.

This will open a new Timeline.

2. Open the  **Search** (Explorer) tool in the top bin toolbar to open the network database search tool.

This will bring up the search tool.

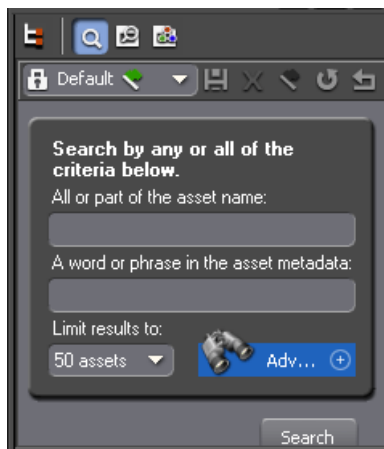

3. Set up an Advanced search in MediaFrame by selecting the **Adv...** button.

This will bring up the Advanced Search window.

4. Select the  **Add Filter** button in the Advanced Search window. Add a filter that will find All Offline assets.

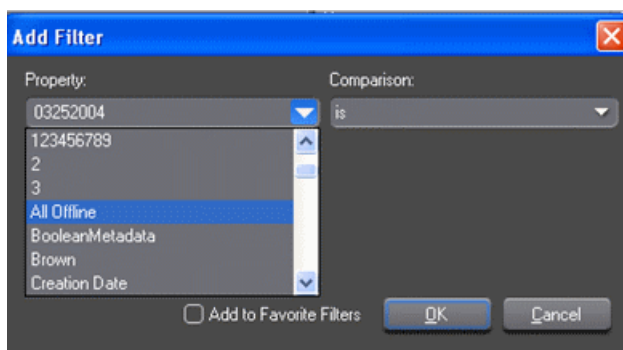

5. The search results will appear in the Bin contents area.

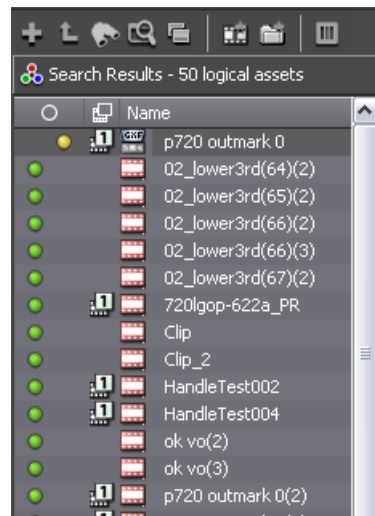

- Offline assets can be identified by an orange dot.

This search resulted in finding one offline asset.

Related Links

[About searching with filters](#) on page 67

Moving offline assets to the Timeline

Once you have acquired the offline assets by searching using the MediaFrame database search, the offline assets will show up in the bin: offline clips are identified by an orange dot. The offline assets can be moved to the Timeline via the Clip Player.

- After finding offline assets in your MediaFrame search, double-click any offline asset identified by an orange dot in the bin to place it in the Clip Player, then copy it to the Timeline with the  **Copy To Timeline** button in the Clip Player.

The clip will appear with an orange line at the top indicating it is an offline asset that has not yet been restored. Any number of offline clips can be copied to the Timeline, each indicated by an orange line at the top of the clip.

NOTE: *You can mix offline and online assets on the same Timeline.*

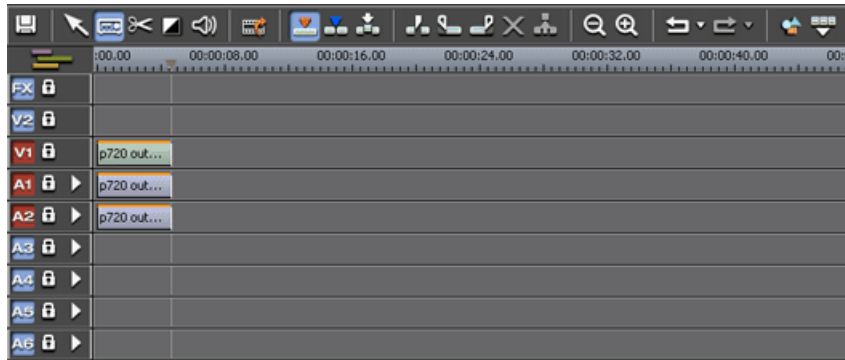

2. Edit the offline clip(s) in the same manner as online clip(s) with any of the Timeline tools.

Restore and synchronize offline assets

Once an editor decides their story using offline assets is complete (or anytime during an edit session), the sequence can be restored and synchronized for playout.

1. To restore the clips for sending to playout or anytime during the session, select the  **Restore Sequence Asset** button in the top menu bar.

This will bring up a message asking you to save the sequence; select **Yes**.

2. If the user has a restore role assigned in MediaFrame configuration, a **Restore Assets** dialog will appear.

If the user does not have a restore role assigned to them, the Collections dialog will come up allowing them to add the sequence to a collection for a media manager to handle. For more information about Restore Roles, see the *Aurora Browse User Guide*.

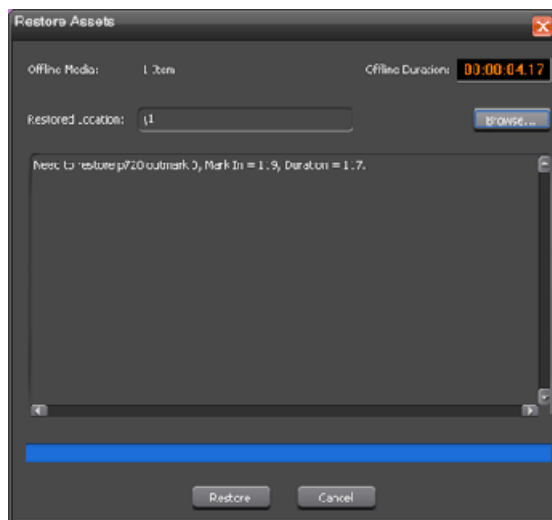

The **Restore Asset** dialog will report the number of assets to be restored, the total duration of media to be restored, and allow you to select the Restored Location folder within the database where the restored assets will be saved.

NOTE: *During the restore, it may be only a partial file that is being restored, for example you may take only 10 seconds from an hour long file. What will actually be restored is 10 seconds and user-definable handles.*

3. Select the **Restore** button at the bottom of the dialog box to start the restore process.

Another dialog box will appear telling the user the number of restore jobs that have been successfully submitted. If this is correct, select **OK** to continue the restore process.

4. To view the status of the restore, select the  **Transfer Manager** button in the top menu bar.

The Transfer Manager launches and will list the assets being restored and show status of the restore.



- Once the assets are restored, the clip(s) will still indicate that they are offline by the orange bar on top of the clip(s). At this point they will need to be synchronized to the project.

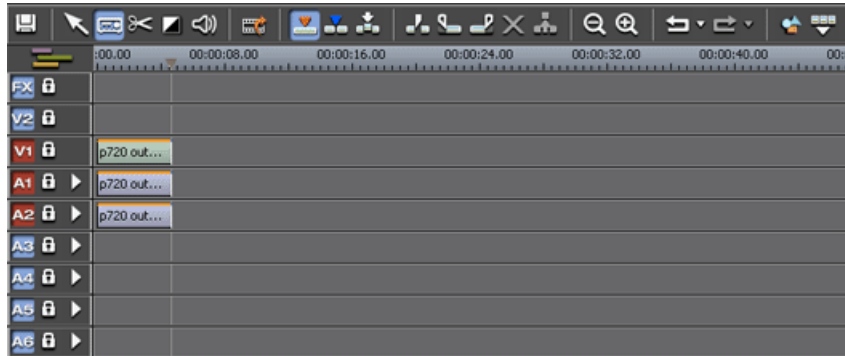

- To synchronize the clip(s) to the project, select the  **Synchronize Restored Assets** button at the top of the menu bar.

This will bring up the Synchronize Restored Assets dialog showing the synchronized clips and indicating that it is complete.

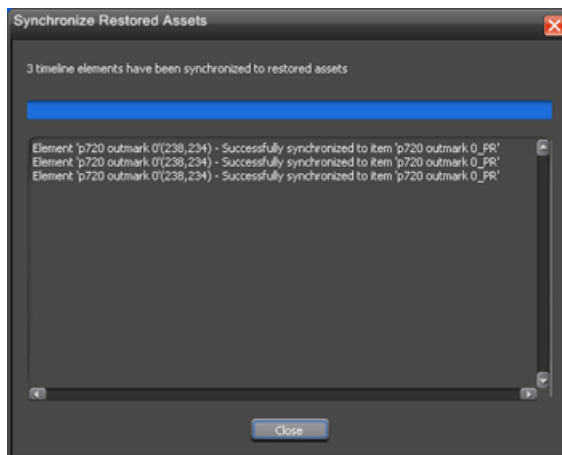

Once synched up to the project the clips will appear as online media on the Timeline.

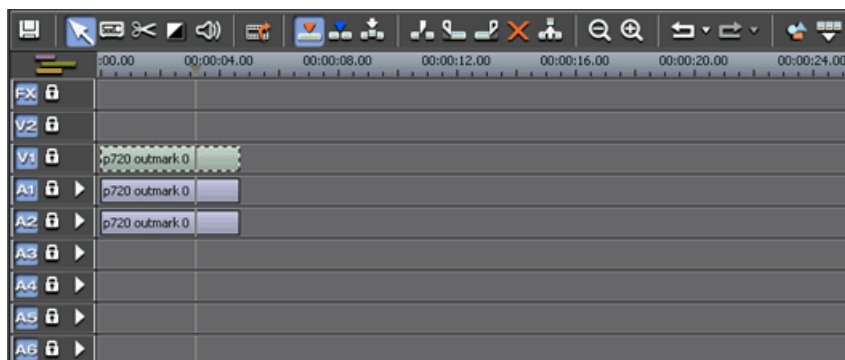

NOTE: In Aurora Edit and Aurora Edit LD, once the video is synchronized, the tops of the clips may have a blue bar. The blue bar will appear depending on the media and the format of the Timeline. If the hi-res media does not match the Timeline format, the blue bar will be present.

- The project is ready to be sent to playout.

Unlinking restored assets

Once the project has been sent to playout, the editor has the option to unlink all offline restored asset(s) or any single restored asset from the sequence, returning the restored assets on the Timeline to proxy references.

If the restored assets no longer need to be stored in hi-res format on the Timeline. Unlinking the restored assets will still preserve their position on the Timeline with lo-res media and they will still be available for previewing the story or for future restores.

There are three ways to unlink restored assets as described below.

- To unlink all of the restored assets from the Timeline at once, select the  **Unlink Restored Assets** button at the top of the menu bar.

This will open the Unlink Online Assets dialog which will show the assets that have been unlinked.

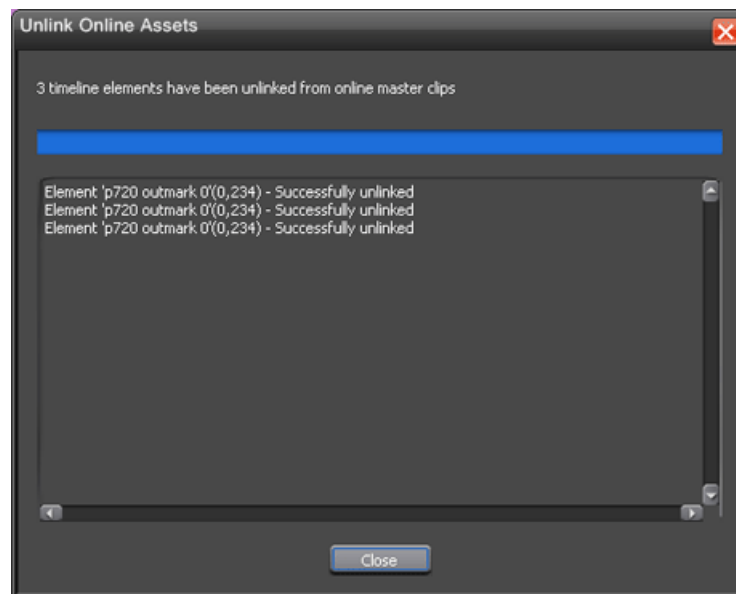

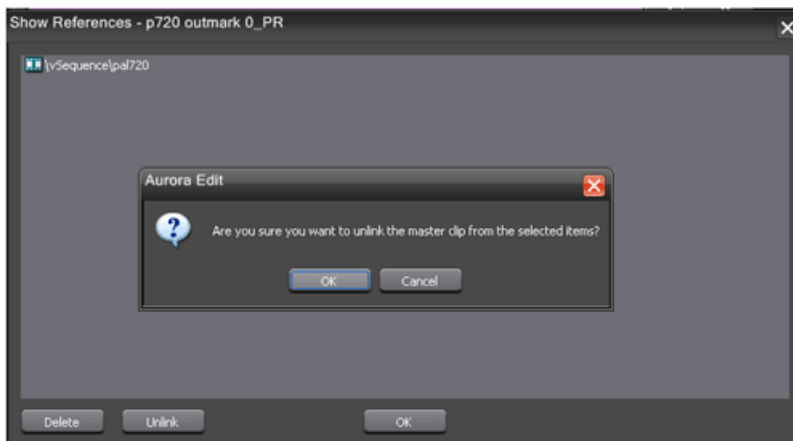

- To unlink a single clip from the Timeline, right click in the clip you wish to unlink and select the Unlink Restored Asset selection from the pop-up menu. A dialog will appear showing that only this clip is being unlinked.
- Another way to unlink restored assets is to use the **View | Show References** control in the top menu bar. A clip must be selected for this option to be available.

The Show References dialog will list all of the sequences or sub-clips that a master clip is currently tied to. Media cannot be deleted if it is linked to assets, so using the Show References dialog allows a user to select a number of sequences and opt to unlink the master clip from them if the master clip is archived. This provides a faster way for an operator to delete the online asset.



On the Timeline, the clips that have been restored and synchronized will be unlinked from the Timeline and return to offline clips indicated once again by the orange bar over the clips.

Both Restore and Unlink functions can be undone. You can use the  **Undo** button in the Timeline Toolbar to re-link the restored synchronized clip(s) or use the  **Redo** button to change back to return to an unlinked state.

NOTE: *Only archived media can be unlinked from the Timeline. If a clip that has not been archived is on the Timeline and you attempt to unlink it, the Unlink Online Assets dialog will come up indicating that no clips have been unlinked and the archived asset was not found. This prevents loss of unarchived media on the Timeline when an unlink function is performed.*

Linking video MOS objects to the Timeline

Within the Aurora Suite, both feed events and finished stories become MOS Objects within the newsroom computer system. The MOS Objects may be searched on and linked to stories for use within Aurora Edit.

Once a feed has been started in the Aurora Ingest Scheduler application, the video become searchable within ENPS. This provides a fast method of finding feed material and placing it into a news story as a MOS object that can easily be brought into Aurora Edit and edited as desired.

1. To search for video material using ENPS, use the ENPS search function as described in the news application. The ENPS search must account for Grass Valley clips within the filter.

The example of an ENPS search and a script shown here uses Grass Valley as the search criteria.

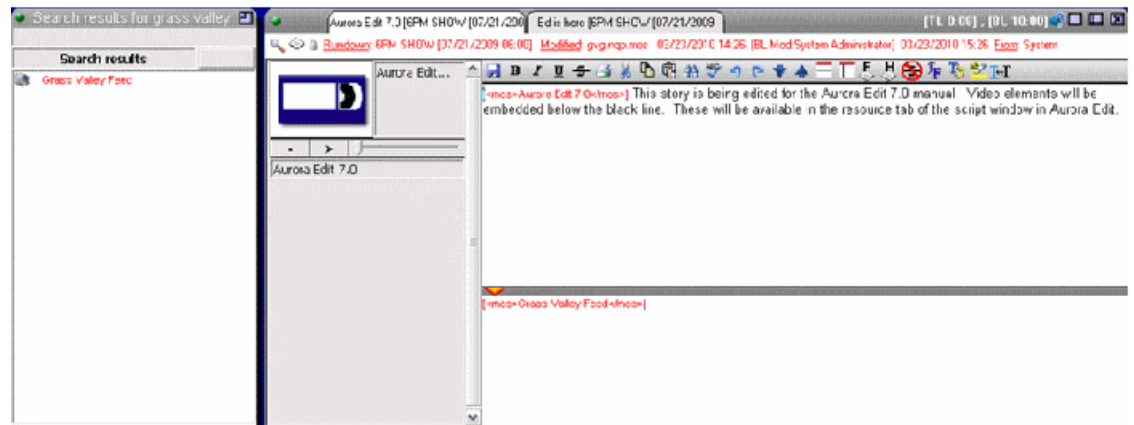



2. The ENPS operator drags and drops the Grass Valley video clip to the area below the black line within the ENPS script.

Once video elements are saved below the black line, they are linked to the script.

3. The editor can now link to the script by creating a new sequence, linking to the Assignment List from the sequence, selecting the story being created and then select the  **Story View** button at the top left of the Aurora Edit application.

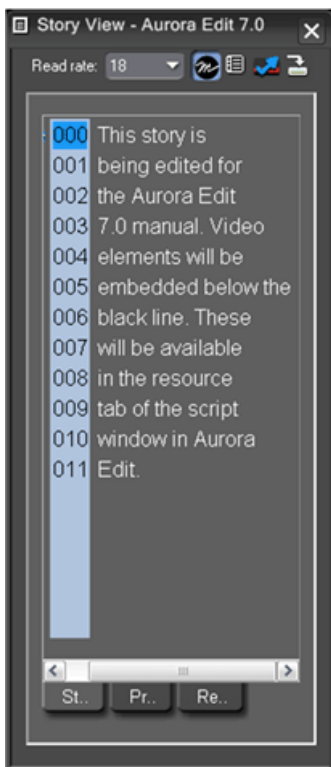
When video MOS objects are linked to the script, the Story View window will have a **Resources** tab.



4. Select the **Resources** tab to show the video MOS objects linked to the script. Hovering over the MOS object  shows a tooltip and selection hand. Information about the clip is also included.



5. Click on the MOS object and the video, either online or offline, will load into the Aurora Edit Clip Player.

From here, the clip can be copied to the Timeline and edited for playout.

Related Links

[Story View functions](#) on page 103

About Aurora Edit and Final Cut Pro

This topic describes the different ways you can integrate Aurora Edit and Aurora Edit LD with Final Cut Pro.

Aurora Edit allows you to work with Apple's Final Cut Pro video editing application. Files created in Aurora Edit and in a shared environment on K2 storage include a .mov file as one of its components, which makes it compatible with the Final Cut Pro format. You can use Final Cut Pro and Aurora Edit in two different ways in your newsroom workflow:

- Create a sequence in Aurora Edit and export the sequence as an XML EDL that can be imported into Final Cut Pro, then finish editing using Final Cut Pro.
- Create a sequence from scratch in Final Cut Pro and choose clips directly off K2 storage.

The devices and software components that support Aurora Edit and Aurora Edit LD workflows are as follows:

- Final Cut Pro installed on a Macintosh system
- K2 FCP Connect – This is a Grass Valley product that provides optimal performance. It is a toolset that must be purchased, installed, licensed, and configured. It includes GV Connect, which is a Final Cut Pro plug-in.
- Aurora NewsShare on K2 SAN storage
- A K2 system with stand-alone storage

Refer to your Aurora product release notes as well as the *K2 FCP Connect Release Notes* for version compatibility information.

For detailed instructions refer to documentation as follows:

- Connecting and using Final Cut Pro on K2 storage – Refer to the K2 FCP Connect documentation set, which includes the following documents:
 - K2 FCP Connect Installation Manual
 - K2 FCP Connect Release Notes
 - GV Connect User Manual
- Workflows for Aurora Edit and Final Cut Pro – Refer to topics later in this manual.

Exporting an Aurora Edit sequence as a Final Cut Pro EDL

You can export a sequence from Aurora Edit to a Final Cut Pro machine when both machines are part of a Network Attached Storage (NAS) system.

This allows for quick editing of a sequence on Aurora Edit and then transferring the unfinished piece to Final Cut Pro for additional editing.

Files are transferred using Aurora Edit's XML EDL format and Apple's XML Interchange format. These components of the sequence are transferred:

Clips
Rendered effects and titles
Dissolves (other wipes are converted to a dissolve)
Varispeed
Fit to Fill
Audio voice disguise (but not EQ)

1. Highlight the sequence in the Bin you want to export.
2. Choose **File | Export | Final Cut Pro EDL**.
3. Navigate to the folder where you want to export the EDL.
4. Enter a name for the file and click **Save**.

You can now import the file using Apple's Final Cut Pro application.

Importing an Aurora Edit sequence on Final Cut Pro

You can import an XML EDL from Aurora Edit into Final Cut Pro, which allows you to perform additional editing.

1. In Final Cut Pro, select **File | Import | XML**.
The Choose a File window appears.
2. Navigate to the folder containing the XML file you want, select the file, and click **Choose**.

The file is imported into Final Cut Pro.

Exporting a Final Cut Pro file

Once you are finished editing a clip in Final Cut Pro, you can export it in a format that Aurora Edit recognizes. This allows you to playout the clip/sequence using a Grass Valley DNP product.

1. In Final Cut Pro, select **File | Export | Export to Grass Valley**.
The Grass Valley Export window appears.
2. Enter a name for the file in the Save As field.
3. Select a location for the file.
4. Click **Save**.

The file is converted from a .mov file into an Aurora Edit clip.

Converting existing Aurora Edit files to .mov format

Any clip on a Network Attached Storage (NAS) System automatically includes a .mov file as one of its components. This allows you to bring an Aurora Edit sequence into Final Cut Pro for additional editing.

1. Go to **C: | Program Files | Grass Valley | Aurora Edit** and select **MediaServicesTestApp**.
2. Choose **Utility | Create MOV from VMF**.
3. Enter the name of the database server where you want to convert the files and click **OK**.
4. Select the bin that you'd like to convert and click **OK**.

The files begin converting. This process may take a while, depending on how many files you are converting.

Opening an Aurora Edit clip on Final Cut Pro

You can also open an Aurora Edit clip on Final Cut Pro instead of importing the entire sequence.

1. In Final Cut Pro, select **File | Open Grass Valley**.

The Grass Valley Import window appears.

2. Select the clip and click **Open**.

The clip opens in Final Cut Pro and is available for editing.

Video effects

This section contains the following topics:

- *Creating video effects - overview*
- *Understanding video effects*
- *Moving the foreground image within the viewer window*
- *Adding a video effect to the Timeline*
- *Choosing a video effect*
- *Working with keyframes*
- *Setting a path for your video effect*
- *Viewing video effects within your sequence*
- *Saving video effects*
- *Rendering video effects*
- *Layering video effects*
- *Exporting video effects*
- *Effects & what they do*
- *Options for resize or key shape effects*

Creating video effects - overview

Adding video effects to your sequences involves choosing the effect you want, determining the effect duration, and adding keyframes to the effect. Aurora Edit also provides a number of preconfigured video effects that you can drag directly onto the Timeline.

You create a video effect using the Video Effects Tool and by following these steps. Each step is further discussed in its own topic.

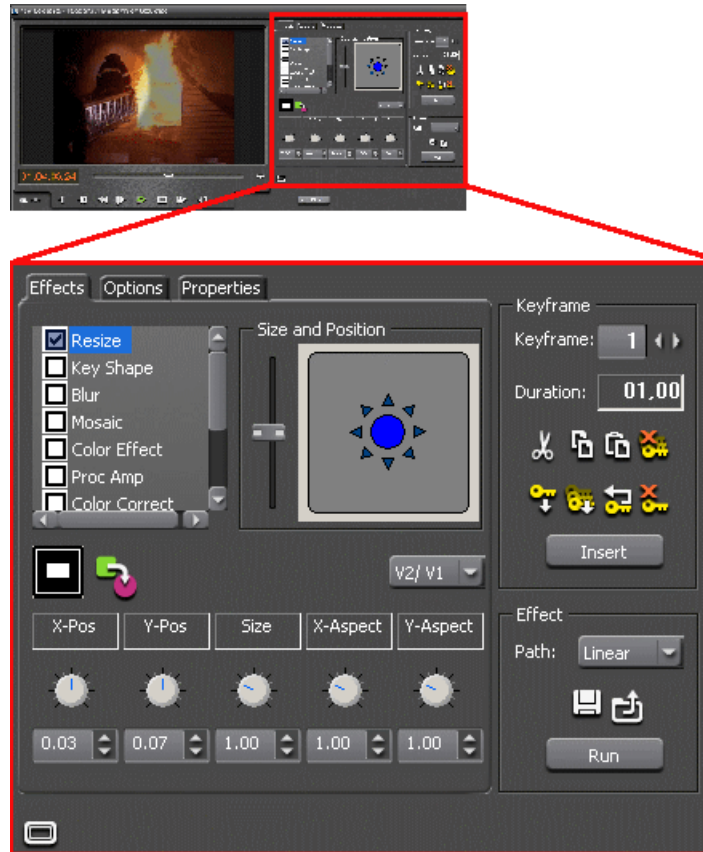

1. Place an effect on the Timeline.
The effect can be new, blank, or saved in your Bin.
2. Define the effect by selecting and modifying an effect and its options.
3. Insert a keyframe at the position where the effect starts.
4. Continue to insert keyframes to determine the course of the effect.
5. Select the path to use for the effect.
6. Press **Run** to review the effect.
7. Click **Render**, **Render All**, or **Mixdown** to complete the effect(s).
8. Save the effect to the Saved Effects Bin if you want to re-use it again.

Related Links

[Adding a video effect to the Timeline](#) on page 191

[Choosing a video effect](#) on page 194

[Using video effect options](#) on page 194

[Adding effect properties](#) on page 195

[Inserting keyframes](#) on page 197

[Rendering video effects](#) on page 200

[Saving video effects](#) on page 200

Understanding video effects

With Aurora Edit you can create a variety of video effects with the clips in your sequence, including blurs, mosaics, color inverting, and mirroring. You can also resize video images and use key shapes to create Picture-in-Picture (PIP) effects.

A video effect overlays the video tracks, allowing you to slide the video underneath it on tracks V1 and V2. The effect characteristics are applied to the clips that reside on the video tracks below it, which lets you swap one video effect for another or one video clip for another.

When you create a Resize or Key Shape effect, one of the video tracks becomes the foreground and the other becomes the background. With a Resize Effect, the foreground image defaults to 50% the size of the background image and is visible. When you apply a Key Shape effect to a single video track, you cannot see the initial key shape until you apply an effect to it. When you add another effect to the Key Shape effect, you can then see the shape and position it.

You can manipulate the foreground image in five different ways:

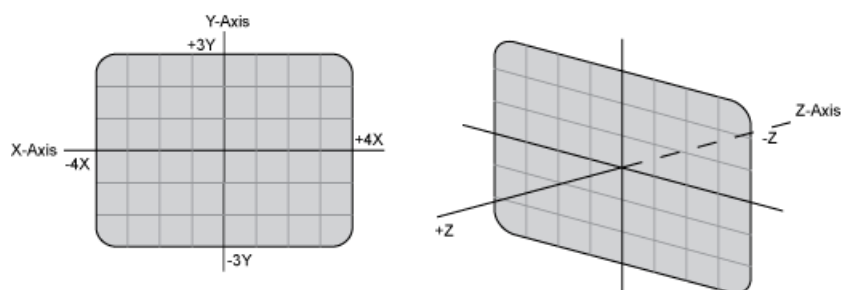

- X-Axis — The image moves left or right.
- Y-Axis — The image moves up or down.
- Z-Axis — The image moves either closer or farther away, giving the impression that the foreground is getting either larger or smaller, respectively.
- X-Aspect — The image stretches or shrinks along the X-Axis.
- Y-Aspect — The image stretches or shrinks along the Y-Axis.

Related Links

[Adding a video effect to the Timeline](#) on page 191

Moving the foreground image within the viewer window

Aurora Edit has many controls you can use to alter the size and position of the foreground image.

Moving foreground image—dragging image

You can move the image (or a Resize or Key Shape effect) along the X- Y- and Z-axes by dragging it within the Viewer Window.

- When the mouse cursor changes to a hand, use one of these methods to drag the image:
 - Move the image left, right, up, or down by holding the left mouse button down as you drag the image.
 - Change its position on the Z-Axis by holding down the **Ctrl** key while dragging up and down.
 - Lock the mouse movement to the X-Axis or the Y-Axis by holding down the **Alt** key, depending on the direction you move the mouse after pressing the Alt key.

Moving foreground image—using the joystick

You use the joystick to position the foreground image along the X- and Y-axes outside of the viewing area.

1. From the Effects and Options tabs, click the joystick.
2. Move it in any direction to reposition the video image.

Moving foreground image—moving the resize slider

You change the image size (the Z-Axis) by moving the resize slider up to enlarge the image and down to make it smaller.

Moving foreground image—adjusting the dials

You can use the resize and key shape parameter dials to change for X-, Y-, and Z-Axis positions, and X- and Y-Aspect changes.

- Adjust the dials using one of these methods:

- Click the dial and drag right to increase the value or drag left to decrease the value. Double-click a dial to reset it to 0.
- Enter a value in the box below a dial.
- Click the up and down spin controls beside a value box.

Moving foreground image—using the keyboard

You can use the arrow keys on the keyboard to move the foreground image.

- To move the image along the X-Axis, use the left and right arrows
- To move the image along the Y-Axis, use the up and down arrows
- To move the image along the Z-Axis, click **Ctrl +** use the up and down arrows
- To move the image along the X-Aspect, click **Shift +** use the left and right arrows
- To move the image along the Y-Aspect, click **Shift +** use the up and down arrows

Adding a video effect to the Timeline

Creating a new video effect involves placing a blank effect template on the Timeline. The blank effect will contain the keyframes that comprise the effect.

There must be an effects (FX) track present to add a blank effect to the Timeline. When you first create a sequence you can check the **Video Effects Track** checkbox to add an effects track to the Timeline.

If you are working with a sequence without an effects track, click the  **Sequence Properties** button on the Timeline Toolbar and check the **Video Effects Track** checkbox to create the track.

1. Click **Add Effect** within the Video Effects Tool.
2. Enter the duration of the effect (the default is 1 second).
3. Click **OK**.

The effect appears on the Timeline at the pointer location.

Related Links

[Creating video effects - overview](#) on page 188

[Choosing a video effect](#) on page 194

[Using video effect options](#) on page 194

[Adding effect properties](#) on page 195

[Inserting keyframes](#) on page 197

[Rendering video effects](#) on page 200

[Saving video effects](#) on page 200

[Understanding video effects](#) on page 189

Other ways to add a video effect to the Timeline

There are several ways to add a blank effect to the Timeline.

- Highlight the clip(s) for the effect and click **Add Effect** or **Shift + 8**.

You can automatically create a Resize effect by selecting overlapping clips on the two video tracks and clicking **Add Effect**.

Aurora Edit places the effect on the effects track with the same duration as the selected clip(s) and sets the correct track for the effect. For example, if you select a clip on Video Track 1 and add an effect, V1 is automatically designated as the track that receives the effect.

- Mark In and Out points on the Timeline to set the effect duration and click **Add Effect**.

The effect appears on the Timeline at the location and with the duration set by the mark points. If you mark an In point or an Out point but not both, you must enter an effect duration in the pop-up window and click **OK**. The Mark Point you set marks either the beginning of the effect (if you marked an In point) or the end of the effect (if you marked an Out point).

- Right-click on the Timeline, choose **Add Effect**, enter the effect duration (the default is 1 second) and click **OK**.

The effect appears on the Timeline at the pointer location.

Changing the duration of a video effect

You can change the duration of the video effect using the Extend Edit feature.

1. To lengthen or shorten an effect, select the effect on the Timeline.
2. Place the pointer where you want the effect to end or begin.
3. Press **V** on the keyboard.

The effect duration moves to the new pointer position, thereby lengthening or shortening the effect.

Using saved effects in your sequence

Aurora Edit provides a number of preconfigured effects that you can add to your sequence and modify to suit your needs.

You must have the complete Aurora Edit Effects Package to use all of these effects. If you don't have the package you can still use the effects Dip to Black and White, Fade from Black, and Fade to Black.

The preconfigured effects are stored in an Effects Bin, and include these effects—Dip to Black and White, Dip to Color, Fades, Flash Dissolve, Spotlight, and White Flash. Saving effects saves their duration, but the duration of an effect you place on the Timeline depends upon on the way you add the effect to your sequence.

Select one of these methods to add a saved effect to your sequence:

- Drag and drop the saved effect onto the Timeline — the effect duration is exactly as it was when saved and the keyframes are in the same positions.
- Highlight the clip(s) for the effect and drag the saved effect onto the Timeline — the effect duration and keyframes adjust to match the duration of the selected clip(s).
- Mark In and Out points on the Timeline to define the effect duration and then drag a saved effect onto the Timeline — the effect duration and keyframes adjust to fit the duration between the mark points.
- Click **Open**, select the effect, and click **Open** — the duration follows the above guidelines based on whether you select mark points or a clip for the effect.

Once you have the effect on the Timeline, you can use the Video Effects Tool to modify the effect.

Related Links

[Importing effects](#) on page 83

Importing video effects

You can use effects that are located on another Aurora Edit workstation, another computer, a network server, or a diskette, by importing them into your Aurora Edit sequence.

You can only import effects with a .vef suffix. You can import effects to the Bin or directly to the Timeline, depending on which window has focus.

Aurora Edit provides some pre-configured video effects, which you can add to your sequence quickly without having to define and adjust characteristics. The effects are located at **C: | Program Files | Grass Valley | Aurora Edit | Effects**.

1. Choose **File | Import | Effect**.

The Import Effect window appears.

2. Navigate to the effect you want to import and select it.
3. Click **Import**.

A progress bar indicates the import status.

Related Links

[Exporting video effects](#) on page 201

[Saving video effects](#) on page 200

Choosing a video effect

After you add a blank effect to the Timeline, you choose the video effect to create in your sequence.

1. Press **8** on your keyboard or click the  **Video Effects Tool** button on the Timeline Toolbar.
2. Click the **Add Effect** button, enter the duration of the effect, and click **OK**.

A new blank effect is added to the Timeline.

3. Check the checkbox next to the effect you want to use.

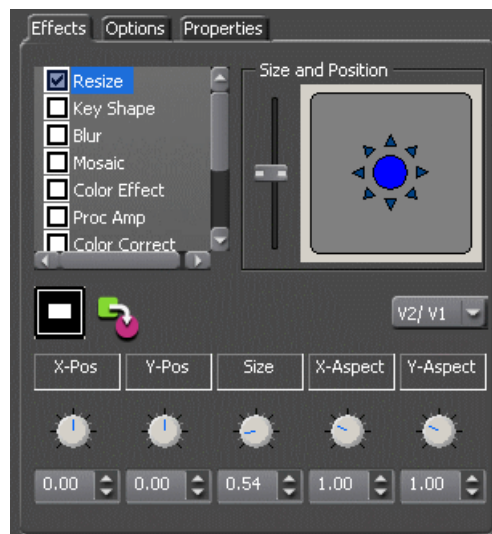

4. Adjust the effect settings as necessary.

Related Links

[Creating video effects - overview](#) on page 188

[Adding a video effect to the Timeline](#) on page 191

[Using video effect options](#) on page 194

[Adding effect properties](#) on page 195

[Inserting keyframes](#) on page 197

[Rendering video effects](#) on page 200

[Saving video effects](#) on page 200

Using video effect options

Video effect options let you further customize your effect in Aurora Edit.

1. Press **8** on your keyboard or click the  **Video Effects Tool** button in the Timeline Toolbar.
2. Click the effect on the FX track you want to modify.
3. Click the **Options** tab in the Video Effects Tool.
4. Select the option you want to use:

Option	Description
Blend	Lets you change the opacity or edge softness of a resize or key shape effect.
Border	Lets you apply a border to a resize or key shape effect, change the color and size of the border, and adjust border placement around the image.
Crop	Lets you trims the foreground image of a resize or key shape effect.
Drop Shadow	Lets you apply a drop shadow to the foreground image and change the shadow's color and opacity.
Path Control	Lets you apply different paths to a particular keyframe or part of an effect; overrides the chosen effect path.

5. Adjust the effect settings as necessary.
6. To save your settings, click **Insert** for a new keyframe or click **Modify Keyframe** if the keyframe already exists.

Related Links

- [Creating video effects - overview](#) on page 188
- [Adding a video effect to the Timeline](#) on page 191
- [Choosing a video effect](#) on page 194
- [Adding effect properties](#) on page 195
- [Inserting keyframes](#) on page 197
- [Rendering video effects](#) on page 200
- [Saving video effects](#) on page 200
- [Blend options for Resize and Key Shape effects](#) on page 211
- [Border options for Resize and Key Shape effects](#) on page 212
- [Cropping options for Resize effects](#) on page 212
- [Drop shadows for Resize and Key Shape effects](#) on page 213
- [Path Control for keyframes](#) on page 214

Adding effect properties

You may want to add some descriptive information about the video effect you create. Effect properties help you remember the characteristics of the effect.

1. On the FX track, click the effect for which you want to add properties.
2. Click the **Properties** tab in the Video Effects Tool.
3. Enter the effect name and a description.

Related Links

[Creating video effects - overview](#) on page 188

[Adding a video effect to the Timeline](#) on page 191

[Choosing a video effect](#) on page 194

[Using video effect options](#) on page 194

[Inserting keyframes](#) on page 197

[Rendering video effects](#) on page 200

[Saving video effects](#) on page 200

Working with keyframes

Understanding keyframes

Aurora Edit uses keyframes to synchronize a clip's video effects with the video and audio. A keyframe is a set of characteristics defining the image at a specific instant in time.

Keyframe characteristics include size, location, borders, drop shadow, and cropping but do not include the video image, which resides on the video track.

After creating a video effect, you insert a keyframe to mark the effect's location and characteristics on the Timeline. All effects need at least one keyframe.

If you want the effect to play consistently through the clip, you only need one keyframe. If you want the effect to change throughout the clip, continue to adjust characteristics and insert keyframes throughout the clip as necessary.

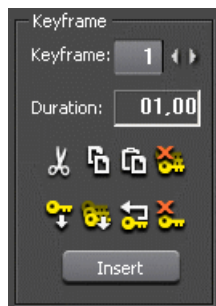

Within the Video Effects Tool, some parameters are keyframeable and some are not. That is, if a parameter is keyframeable, the parameter can change from one keyframe

to the next. If a parameter is not keyframeable, that parameter is used for the entire effect and cannot change across keyframes. The type of effect is not keyframeable.

Related Links

[Importing a TGA animation sequence](#) on page 86

[Video effect paths](#) on page 199

Inserting keyframes

Keyframes can be added to any point of a video effect, and are used to mark the video effect's location and characteristics on the Timeline.

You can add keyframes to any point of a video effect. There are two general approaches for inserting keyframes. In the first approach, you step through the video and insert a new keyframe at each point where you want the effect to move. This method is useful when creating a blur or mosaic effect or when you want to move an effect to cover or highlight a specific area.

In the second approach, you set up the first keyframe and insert it into the effect. Then set up a second keyframe and insert it. Aurora Edit automatically places the second and subsequent keyframes one second after the previous one. This method is useful with resizing effects such as Picture-in-Picture that are less dependent on exact frame positions than on the effect's path and speed.

1. Place the pointer at the spot where you want the keyframe.
2. Configure the video effect characteristics using the Video Effects Tool.
3. Press **Insert** on your keyboard or click the **Insert** button on the Video Effects Tool.

A keyframe appears on the FX track on the Timeline. This keyframe places all of the video effect characteristics on a single data point on the Timeline.

4. Continue defining the effect and inserting keyframes as necessary.

Once inserted, you can adjust a keyframe's position by clicking it and then dragging it left or right.

Related Links

[Creating video effects - overview](#) on page 188

[Adding a video effect to the Timeline](#) on page 191

[Choosing a video effect](#) on page 194

[Using video effect options](#) on page 194









[Adding effect properties](#) on page 195

[Rendering video effects](#) on page 200

[Saving video effects](#) on page 200

Modifying keyframes

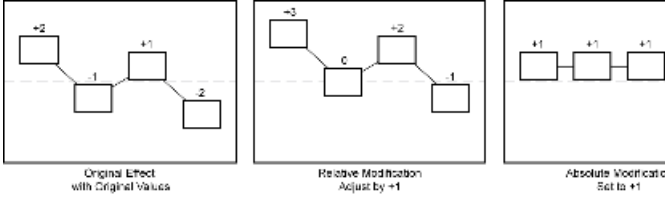
Aurora Edit provides some standard tools for modifying keyframes:

Icon	Tool	Description
	Cut	Removes a keyframe and places it on the clipboard for pasting into another position or effect.
	Copy	Copies a keyframe for pasting into another position or effect.
	Paste	Pastes the properties of a cut or copied keyframe in a new position.
	Delete All	Deletes all of an effect's keyframes.
	Modify	Changes the characteristics of an existing keyframe.
	Modify All	<p>After modifying the characteristics of a single keyframe, allows you to apply those changes to all keyframes within the effect. When modifying all keyframes, you can choose the type of modification you want:</p> <ul style="list-style-type: none"> • Relative--Alters each keyframe in relation to its current status • Absolute--Alters all keyframes to the value set in the modifying keyframe, regardless of each keyframe's current status
 <p>The diagram shows three scenarios of keyframe modification. The first, 'Original Effect with Original Values', shows a path with five keyframes having values +2, -1, +1, 0, and -2. The second, 'Relative Modification Adjust by +1', shows the same path where each value is increased by 1, resulting in +3, 0, +2, +1, and -1. The third, 'Absolute Modification Set to +1', shows all keyframes in the path set to the value +1, regardless of their original values.</p>		
	Restore	Restores default settings to the current effect position.
	Clear	Allows you to return to an original keyframe if you have altered it and want to use the previous settings instead.

Setting a path for your video effect

Each video effect you create has a path that determines how the effect behaves from keyframe to keyframe.

You can apply paths only to an entire effect, not just a particular keyframe or part of an effect. If you want to apply a path to a specific keyframe, use the Path Control feature in the Options tab.

1. In the Effect box of the Video Effects Tool, select a path from the Path drop-down list.

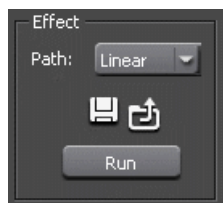

2. To see how the path affects your sequence, click **Run**.

Video effect paths

Video effects have paths which determine how the effect plays from keyframe to keyframe.

Aurora Edit has four path types:

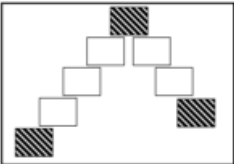
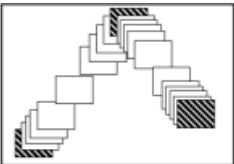
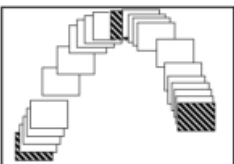
Path Type	Example	Description
Hold		The effect characteristics hold for the duration of the keyframe and then change instantaneously to the next keyframe. For example, the image jumps from its location in one keyframe to a new location in the next keyframe.
Linear		The effect plays in a constant direction and at a constant rate of speed from keyframe to keyframe. For example, the image moves from one location to the next in a straight line at the same speed.
S-Linear		The effect plays in a constant direction but at a variable rate of speed from keyframe to keyframe. For example, the image moves from one location to the next in a straight line; it begins slowly, speeds up, then slows down again as it approaches the next keyframe. Because of the changing speed, S-Linear changes appear less abrupt than linear changes.
Curve		The effect plays in a variable direction and at a variable rate of speed, causing a rounded path through the keyframe. For example, the image moves from one location to the next in a smoothly curved line. The Curve path is the least abrupt type of path control; both direction and rate of speed are kept smooth and steady in appearance.

Related Links

[Understanding keyframes](#) on page 196

Viewing video effects within your sequence

Once you create an effect, you can view it with the clip to see if you need to make further adjustments.

- View the video effect with your clip by:
 - Pressing **Ctrl + W** on your keyboard
 - Clicking the **Run** button in the Effect area of the Video Effects Tool.

The current video effect plays on the clip.

Saving video effects

Video effects you create can be saved and used again in another sequence.

You save effects the same way you save clips and sequences — in a bin. You can retrieve a saved effect and drag it onto a Timeline in another sequence. When you save a video effect, the effect characteristics such as its duration and keyframes are saved with it.

1. Click the  **Save** button in the Effect box in the Video Effects Tool.
2. Select a bin for the effect and enter a name.
3. Click **Save**.

Related Links

[Creating video effects - overview](#) on page 188

[Adding a video effect to the Timeline](#) on page 191

[Choosing a video effect](#) on page 194

[Using video effect options](#) on page 194

[Adding effect properties](#) on page 195

[Inserting keyframes](#) on page 197

[Rendering video effects](#) on page 200

[Importing video effects](#) on page 193

Rendering video effects

Video effects on the Timeline need to be rendered before sending them to another Aurora Edit workstation or server. Aurora Edit automatically renders effects before sending a sequence, but you can manually render effects in the Timeline.

All unrendered transitions that reside under real-time effects appear as straight cuts until the transition is rendered. Field interpolated slow-motion also becomes frame-based until rendered.

1. Select the effect to render.
2. Render the effect using one of the following methods:
 - Click the  **Render Effects** button in the Main Toolbar.
 - Render all video effects at the same time by clicking the **Render All** button.

Related Links

[Recording completed sequences to tape](#) on page 239

[Rendering transitions](#) on page 141

[Creating video effects - overview](#) on page 188

[Adding a video effect to the Timeline](#) on page 191

[Choosing a video effect](#) on page 194

[Using video effect options](#) on page 194

[Adding effect properties](#) on page 195

[Inserting keyframes](#) on page 197

[Saving video effects](#) on page 200

Layering video effects

Aurora Edit allows you to apply more than one effect to a clip. You can mix down an effect into the video clip below it and then add another effect on the FX track that affects the same clip.

Mix Down modifies the video clip (or clips) in which the effect occurs. For example, if the effect was on V2, the effect collapses into V2. If both video tracks are being affected, the effect collapses onto V1.

1. Select the effect.
2. Mix down the effect using one of these methods:
 - Click the  **Mix Down** button on the main toolbar.
 - Right-click on the effect and select **Mix Down Selected**.

A progress bar indicates rendering status.

Once an effect is rendered, it is removed from the FX track and becomes part of the video clip below it. A new master clip is also created and saved in the Rendered Clips bin.

Exporting video effects

Video effects can be exported (as a .vef file) to locations outside of the Aurora Edit application, such as folders on your computer, to another computer on your network, or to a diskette.

1. Highlight the effect you want to export from the Bin or on the Timeline.
2. Choose **File | Export | Effect**.

The Export Effect window appears.

3. Select a location for the effect and click **Save**.

The video effect exports as a .vef file.

Related Links

[Importing video effects](#) on page 193

Effects & what they do

How video effects work together

Most video effects can be used alone or in conjunction with other effects to create a different, more complex effect. The Blur effect is the only effect that cannot be used alone; you must combine it with the Key Shape effect.

This table shows which video effects can be combined within Aurora Edit.

Effects	Resize	Key Shape	Blur	Mosaic	Color Effect	Proc Amp	Color Correct	Color Invert	Mirror Vert	Mirror Horiz	Luma Key
Resize	X					X		X	X	X	
Key Shape		X	X	X	X	X		X	X	X	
Blur (see Note)		X	X								
Mosaic		X		X							
Color Effect		X			X						
Proc Amp	X	X				X		X	X	X	
Color Correct							X				
Mirror Vert.	X	X				X		X	X	X	
Mirror Horiz.	X	X				X		X	X	X	
Luma Key	X					X					X

NOTE: You can only use the Blur effect in conjunction with the Key Shape effect.

Understanding video effects and keyframes

Within the Video Effects Tool, some parameters are keyframeable and some are not.

That is, if a parameter is keyframeable, the parameter can change from one keyframe to the next. If a parameter is not keyframeable, that parameter is used for the entire effect and cannot change across keyframes.

The type of effect is not keyframeable. The following table lists the type of effect, its parameters and options, and whether each is keyframeable.

Effect	Parameter	Keyframeable	
		Yes	No
	Track Selection		X
	Path	X	
Resize and Key Shape Effects	X-Position	X	
	Y-Position	X	
	Z-Position	X	
	X-Aspect	X	
	Y-Aspect	X	
	Shape		X
Blur	Defocus	X	
	O-Soft		X
Mosaic	Size	X	
	O-Soft		X
Color Effect	Opacity	X	
	Color	X	
Proc Amp	Gain	X	
	Chroma	X	
	Setup	X	
	Hue	X	
	Background	X	
Color Correct	White Balance	X	
	White Clip	X	
	Black Balance	X	
	Gamma Balance	X	
Mirror Vertical			X
Mirror Horizontal			X
Luma Key	Clip	X	
	Gain	X	

Resize video effect

With the Resize video effect, you can enlarge the video image or create a Picture-In-Picture (PIP).

You can use the Resize effect with a single video track or with both video tracks (V1 and V2). You can also use a Resize effect in conjunction with the Proc Amp, Color Invert, Mirror Vertical, and Mirror Horizontal effects. When you use resize with one video track, you are generally enlarging the image. Enlarging lets you zoom in on a still image, remove a logo, or highlight print. When you use resize with two video tracks, you create a Picture-in-Picture (PIP) with V2 in the foreground and V1 in the background.

To resize an image, use the slide control or adjust the dials.



Option	Range	Description
X-Position	-32 to +32 (4:3) -128 to +128 (16:9)	Moves the image left or right.
Y-Position	-24 to +24 (4:3) -72 to +72 (16:9)	Moves the image up or down.
Size	0 to 4	Moves the image closer or farther away.
X-Aspect	0 to 4	Adjusts the image width left to right.
Y-Aspect	0 to 4	Adjusts the image height top to bottom.
Shape	Change the shape of the Key Shape effect by clicking the Change button on the Effects tab, selecting a new shape, and clicking OK.	

Key Shape video effect

You can use the Key Shape effect with a single video track or with both video tracks (V1 and V2). You can also use a key shape effect in conjunction with these effects: Blur, Mosaic, Color Effect, Proc Amp, Color Invert, Mirror Vertical and Mirror Horizontal.

When you use a Key Shape effect with one video track, you can create a variety of effects. You can apply a Blur or Mosaic effect in conjunction with the key shape to block out a face. You can also use this effect for other purposes, including creating a highlight with Proc Amp and bringing up the gain of the video image through a small hole, adding a gray blotch if the Blur and Mosaic effects aren't sufficient, or creating a spotlight effect.

You use two video tracks with the Key Shape effect in much the same way as you use a PIP. However, a Key Shape effect only provides the shape instead of resizing the image. In order to see the key shape image, you need to choose V2 to be over V1 in the Video Effects Tool (Select **V2/V1** from the Track drop-down box in the Effects tab). The key shape appears to "punch a hole" through V1 with the V2 image displaying in the key.

To position a Key Shape effect, drag the image in the Video Window or use the Left and Right arrow keys on the keyboard.

Option	Range	Description
X-Position	-32 to +32 (4:3) -128 to +128 (16:9)	Moves the key shape left or right.
Y-Position	-24 to +24 (4:3) -72 to +72 (16:9)	Moves the key shape up or down.
Size	0 to 4	Moves the key shape closer or farther away.
X-Aspect	0 to 4	Stretches or shrinks the key shape from the left and right.
Y-Aspect	0 to 4	Stretches or shrinks the key shape from the top and bottom.
Shape	Change the shape of the Key Shape effect by clicking the Change button on the Effects tab, selecting a new shape, and clicking OK.	

Blur & mosaic video effects

Blur video effect

You use the Blur effect to cover up an image that needs to be protected or disguised.

When you select the Blur effect, the Key Shape effect automatically turns on. This is because you need the Key Shape effect to select the size, shape, and position of the blur. You cannot create a Blur effect without using the Key Shape effect as well.

When covering up an image throughout a clip, you probably have to move the blur effect several times in order to cover the image as the clip plays. You can do this quickly using the keyboard keys.



Option	Range	Description
Defocus	0 to 5	0 is no blur and 5 is the heaviest blur.
O-Soft	0 to 100	0 is no softness and 100 is full softness for the outside region of the shape.

Mosaic video effect

You use the Mosaic effect to cover up an image that needs to be protected or disguised.

When you select the Mosaic effect, the Key Shape effect automatically turns on. This is because you need the Key Shape effect to select the size, shape, and position of the mosaic. Unlike the Blur effect, however, you can turn off the Key Shape effect, giving the entire image a mosaic effect.

When covering up an image throughout a clip, you probably have to move the mosaic effect several times in order to cover the image as the clip plays. You can do this quickly using the keyboard keys.



Option	Range	Description
Size	0 to 5	0 is no mosaic at all and 5 is the largest block size.

Option	Range	Description
O-Soft	0 to 100	0 is no softness and 100 is full softness for the outside region of the shape.

Creating a Blur or Mosaic effect

You can use the Aurora Edit keyboard to create a blur or mosaic effect.

1. Add a blank effect to the Timeline and select it.
2. Check the Blur or Mosaic checkbox to choose the effect.
3. Find a size and shape for the effect that you like.

Move the slider up or down to change the size of the effect; check the Key Shape box on the Effects tab and click **Change** to change the shape.

4. Move the blur or mosaic pattern over the image at the beginning of the effect.
5. Hit **Insert** on the keyboard.

This places a keyframe in the effect on the Timeline.

6. Using the **A**, **S**, **D**, and **F** keys, step through the clip to determine if you need to move the effect pattern in order to cover the image.
7. If you need to move the effect, use the left, right, up, and down arrow keys to place the blur or mosaic pattern over the image.
8. Hit **Insert** on the keyboard.
9. Continue until the end of the clip.

If you need to resize the effect, press the Ctrl + Up and Down keys.

Color Effect

Use the Color Effect to create an area of color, either as a standalone effect or in conjunction with the Resize or Key Shape effects.

You can change the color and the opacity to create the effect you want.

Option	Range	Description
Opacity	0 to 100	0 is not visible at all and 100 is opaque.
Color	Standard Windows color picker	Change the color by clicking the Change button on the Effects tab and selecting a new color.

Proc Amp video effect

You adjust video levels using the Proc Amp effect. You use this effect either as a standalone effect or in conjunction with the Resize or Key Shape effects.

You use four controls — Gain, Chroma, Setup, and Hue — to alter the entire image or part of the video image.

One way to use the Proc Amp effect is to spotlight an image. You create a key shape within a single track of video, check the Background checkbox, and increase the Gain in order to bring out the spotlight within the video image.



Option	Range	Description
Gain	-100 to +100	-100 appears black and +100 washes out with brightness. 0 is the default.
Chroma	-100 to +100	-100 appears black and white while +100 boosts the color scheme. 0 is the default.
Setup	-100 to +100	-100 crushes the black levels while +100 increases the brightness. 0 is the default.
Hue	-180 to +180	Sweeps from -180 to 180 cycles through the entire spectrum of colors altering the image.
Invert	On or Off	Gives a film negative look to the image by inverting all of the colors within the video image.
Background	On or Off	Within a Resize or Key Shape effect, lets you adjust the background video layer.

Color correction video effect





You adjust the colors in a video image using the Color Correct effect.

For a quick color correction, just use the White Balance parameter. For a complete color correction, use the parameters in this order for best results:

- Black Balance
- White Balance
- White Clip
- Gamma Balance

You can adjust colors individually using the dials or automatically. To adjust a dial, click the dial and drag right to increase the value or drag left to decrease the value. Double-click a dial to reset it to 0.

You can also make adjustments entering a value in the box below a dial or by clicking the up and down spin controls beside a value box.

Parameter	Option	Range	Description
	Red	-100 to +100	Increases or decreases the component's overall level (gain) relative to the other colors; used to achieve "true white" in a specific part of the image. You can adjust each color individually or use the automatic adjustment (select a white area of the image you want to adjust to using the eyedropper).
	Green		
	Blue		
	All		
	Red	0 to 108	Limits the values of the red, green, and blue components of an image. You can adjust each color individually or use the automatic adjustment (select a white area of the image you want to adjust to using the eyedropper).
	Green		
	Blue		
	All		
	Red	-20 to +20	Changes the pedestal of the red, green, and blue components of an image; provides a black or null offset for each color component. You can adjust each color individually or use the automatic adjustment (select a white area of the image you want to adjust to using the eyedropper).
	Green		
	Blue		
	All		
	Red	1.00 to 4.40	Lets you bring out more detail in a color component; applies different values of gamma to the red, green, and blue components of an image. You adjust each color individually.
	Green		
	Blue		
	All		

Using automatic color correction

You can have Aurora Edit correct color parameters automatically.

1. Click a parameter button for the parameter you want to adjust.

Select from White Balance, White Clip, Black Balance, or Gamma Balance.

2. Using the eyedropper on the video image, drag a box around an area that represents the best color for the parameter you're adjusting.

For example, select the “whitest” area if you are adjusting White Balance.

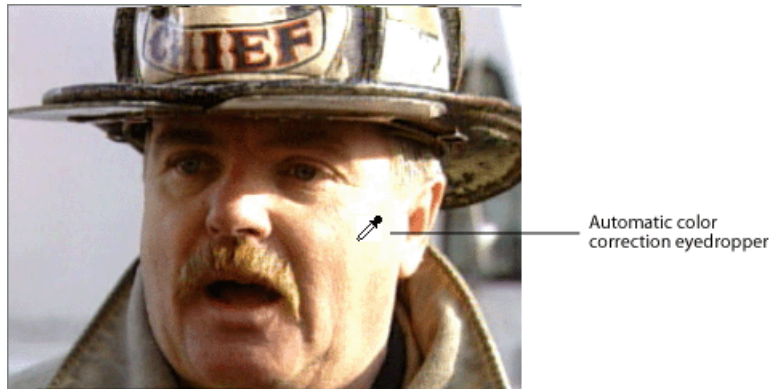

3. Let go of the mouse.

Aurora Edit adjusts the color in the video image automatically.

4. Repeat steps 1-3 for the other parameters.

Mirror Vertical video effect

The Mirror Vertical video effect flips the image vertically providing an upside-down view of the image.

You use the Mirror Vertical effect either as a standalone effect or within the Resize or Key Shape effects. The Mirror Vertical effect is either On or Off.

Mirror Horizontal video effect

The Mirror Horizontal video effect flips the image horizontally providing a reverse view of the image.

You use the Mirror Horizontal effect either as a standalone effect or within the Resize or Key Shape effects. One way to use the Mirror Horizontal effect is to reverse an interview subject either within a PIP or to change story interviews from one side to the other. The Mirror Horizontal effect is either On or Off.

Luma Key video effect

Keying inserts part of one picture into another to create a composite picture. The Luma Key effect uses the color brightness of an incoming source to specify where to cut the hole in the background.

Option	Range	Description
Clip	0 to 100	Adjusts the luminance (brightness) level in the key signal above which the foreground or key fill video becomes visible over the background video.
Gain	0 to 100	Adjusts the sharpness of the key edge.
Invert	On or Off	Lets you see the video below the clip level; used for keying from dark graphics on a light background.

Options for resize or key shape effects

Blend options for Resize and Key Shape effects

Blend options affect the characteristics of the resize or key shape.

Option	Range	Description
Opacity	0-100	Opacity affects the entire foreground image. The default is 100%, which shows the foreground image and hides the background image. As you change the opacity percentage, the foreground image blends into the background image. Use the opacity option to create fade-ins and fade-outs with Picture-in-Picture (PIP) and to create half-dissolves without fully exposing the background image. 0 is not visible at all and 100 is fully visible.
O-Soft	0-100	The O-Soft option softens the hard line that surrounds the outside of the foreground image. You use O-Soft to blend the outside border of the foreground into the background. 0 is no softness and 100 is the full softness available for the outside region of the shape.
I-Soft	0-100	The I-Soft option softens hard images that are found on the inside border of an image. One way to use I-Soft is to soften a white border for the inside of a PIP. 0 is no softness and 100 is the full softness available for the inside region of the shape.

Related Links

[Using video effect options](#) on page 194

Border options for Resize and Key Shape effects

You can apply a border to any Resize or Key Shape effect for a 4:3 or 16:9 screen image.

You can also change the color and size of a border and add the border from different directions.

Using any of the key shapes, you can alter the border from the left, right, top, bottom, or on all sides. This may mean your image can have an uneven border. To ensure your borders apply evenly, use the dial **All**.

Screen Image	Option	Range	Description
4:3	Left	0-8	The 4:3 image is divided into 8 equal sections, making the border larger as the number increases.
	Right	0-8	
	Top	0-6	
	Bottom	0-6	
	All	0-4	
	Color	Standard Windows color picker	Change the color of the border by clicking the Color icon on the Options tab and selecting a new color.
	Type	1 choice	Inside border only.
16:9	Left	0-32	The 16:9 image is divided into 32 equal sections, making the border larger as the number increases.
	Right	0-32	
	Top	0-18	
	Bottom	0-18	
	All	0-16	
	Color	Standard Windows color picker	Change the color of the border by clicking the Color icon on the Options tab and selecting a new color.
	Type	1 choice	Inside border only.

Related Links

[Using video effect options](#) on page 194

Cropping options for Resize effects

You can crop a Resize effect for a 4:3 or 16:9 screen image.

Cropping an image trims the foreground image from whatever side you select, either left, right, top, bottom, or from all sides. You can also use cropping to center an image or cut out any unwanted video.

Screen Image	Option	Range	Description
4:3	Left	0 to 8	The 4:3 image is divided into 8 equal sections, making the crop larger as the number increases.
	Right	0 to 8	
	Top	0 to 6	
	Bottom	0 to 6	
	All	0 to 4	
	Lock Crop	On or Off	Locks the size of the image box so you can move the video within it without changing the size of the image box.
16:9	Left	0 to 32	The 16:9 image is divided into 32 equal sections, making the crop larger as the number increases.
	Right	0 to 32	
	Top	0 to 18	
	Bottom	0 to 18	
	All	0 to 16	
	Lock Crop	On or Off	Locks the size of the image box so you can move the video within it without changing the size of the image box.

Related Links

[Using video effect options](#) on page 194

Drop shadows for Resize and Key Shape effects

You can apply a drop shadow to the foreground image in your effect for a 4:3 or 16:9 screen image.

In addition to adding the drop shadow, you can change its color, opacity, and amount of offset. To position the drop shadow, use the X-Offset and Y-Offset parameters.

Screen Image	Option	Range	Description
4:3	Opacity	0 to 100	0 is not visible at all and 100 is opaque.
	X-Offset	-4 to +4	-4 is the far left of the foreground and +4 is the far right.
	Y-Offset	-3 to +3	-3 is the upper most limit and +3 is lowest limit from the foreground.

Screen Image	Option	Range	Description
	All	-4 to +4	-4 places the X-Offset at the left and the Y-Offset at the upper most limit while +4 places the X-Offset at the right and the Y-Offset at the lowest limit from the foreground.
	Color	Standard Windows color picker	Change the color of the drop shadow by clicking the Color icon on the Options tab and selecting a new color.
16:9	Opacity	0 to 100	0 is not visible at all and 100 is opaque.
	X-Offset	-16 to +16	-16 is the far left of the foreground and +16 is the far right.
	Y-Offset	-9 to +9	-9 is the upper most limit and +9 is the lowest limit from the foreground.
	All	-9 to +9	-4 places the X-Offset at the left and the Y-Offset at the upper most limit while +4 places the X-Offset at the right and the Y-Offset at the lowest limit from the foreground.
	Color	Standard Windows color picker	Change the color of the drop shadow by clicking the Color icon on the Options tab and selecting a new color.

Related Links

[Using video effect options](#) on page 194

Path Control for keyframes

You can apply different path types to specific keyframes in your sequence with the Path Control option.

Option	Range	Description
Tension	-10 to +10	Controls the length of the tension vector.
Continuity	-10 to +10	Determines the angle of the path into and out of the keyframe.
Bias	-10 to +10	Determines whether the path is pulled towards the previous or the following keyframe.
Path	None Hold Linear S-Linear	See Video effect paths topic for a description of each path type.

Option	Range	Description
	Curve	

Related Links

[Using video effect options](#) on page 194

Chapter 12

Titling and Graphics

This section contains the following topics:

- *Titling and Graphics Overview*
- *Using the Title Tool*
- *The Orad Graphics Tool*
- *The VizRT Graphics Tool*

Titling and Graphics Overview

Aurora Edit and Aurora Edit LD have graphics tools available for inserting graphics and titles on the Timeline Graphics track.

Both Aurora Edit and Aurora Edit LD have the ability to integrate via plug-ins to the optional Orad and VizRT graphic systems. Orad allows an end-to-end workflow from the journalist desktop directly to playout on air. The VizRT workflow includes integration from the journalist desktop directly to the Graphics track on the Timeline. Orad or VizRT must be properly configured in the top menu **Tools | Options | Graphics** pulldown for the proper graphics tool.

Aurora Edit can have a Title tool directly on the Timeline toolbar when the Chyron Lyric plug-in option is installed and licensed. Built-in templates or those you create can be used for integrating titles into a sequence.

Related Links

[Linking to an existing news or sports story](#) on page 101

Using the Title Tool

This section describes using the optional Chyron® Lyric plug-in to add the Title Tool to the Aurora Edit Timeline toolbar.

To use the optional Title Tool **T** on the Aurora Edit Timeline, you must have the Chyron® Lyric plug-in installed on your Aurora Edit workstation and have a Chyron license entered into the License Manager on your desktop. Refer to the *Aurora Edit and Aurora Edit LD Installation Manual* for installing this option.

NOTE: *To use titles in Aurora Edit LD refer to the advanced configuration explained in the Aurora Edit and Aurora Edit LD Installation and Configuration Manual.*

The Aurora Edit Title Tool option lets you add titles to your sequences using built-in templates or those you create. Titles allow you to add your station logo to all of your stories, add newscaster and/or sportscaster names, and other graphics or text you wish to superimpose on your video.

You use the Aurora Edit Titling Tool to add titles to your sequences.

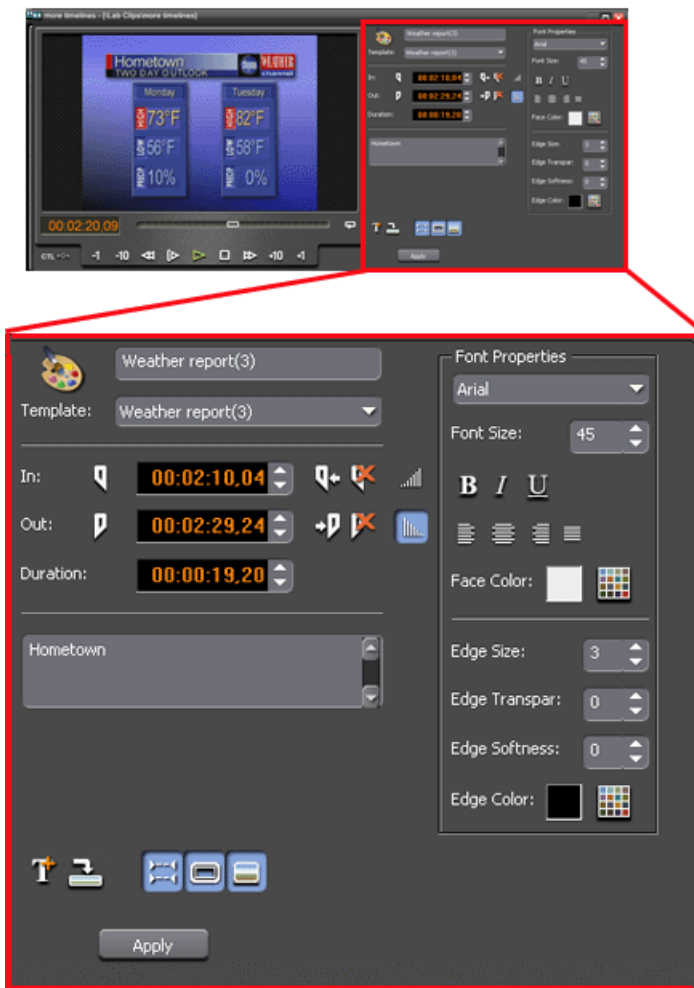



For more information on how to use the Lyric plug-in, see the Lyric online help under **Help | Help Topics**, or see the Chyron documentation.

Using title templates

With the Title Tool available on the Timeline toolbar, Aurora Edit includes several modifiable sample templates, which you can find in the Templates drop-down list. By default, the templates list displays files located in the **C:\LyricDemo** directory.



If you create additional title templates (in .lyr format) that you wish to appear in the Templates list, place them in the samples directory or configure Aurora Edit to use a different directory.

1. Make sure that your sequence has a graphics track; if not, you need to add it:
 - a) With the sequence open, click the  **Sequence Properties** button on the Timeline toolbar.
 - b) In the Sequence Properties window, check **Graphics Track** and click **OK**.
2. Click the  **Title Tool** on the Timeline toolbar to select the Title Tool.



3. Select a template from the Template drop-down list.

The title template appears in the Viewing Window.



4. To remove the background video from the window, toggle the  **Show Background Video** button to show or delete (black background) the background video.
5. You can select the  **Show Safe Area** button to make sure the title is within the proper area for broadcasting.

When selected, the safe title area will appear as a box indicating the safe area.

6. Make any changes to the title graphic.
7. Add a title to your sequence using one of the following methods:
 - Add a Mark In and Mark Out Point on the Timeline and click the  **Copy to Timeline** button—the title appears between the mark points; or
 - Press the  **Copy to Timeline** button with no mark points. The title starts at the cursor position and uses the duration set in the Options menu.

If you need to extend the duration of a title, highlight the title on the Timeline, move the cursor to the new duration point, and press **V** (Extend Edit) on the keyboard.

8. Play your sequence to view the title.

The new title appears on the Graphics track on the Timeline and is saved as a graphic file in the Bin.

To use a saved title in other sequences, drag it onto the Timeline of the new sequence. Aurora Edit copies the title into the new Bin so you can edit it independently from the original.



Modifying a template for your sequence

The default templates contain placeholder text and graphics that you'll need to change for your sequence. You can make changes to any existing text field.

Editing text

You can edit the text in a default template to suit your needs.

Any changes you make to a text field affect the entire field — you cannot change part of a field, such as bolding only one word.

1. Select the Title Tool by clicking the  **Title Tool** button.
2. Verify that the  **Show Text Fields** button is toggled on.
3. Double-click the green arrow at the end of the text field you want to modify.

The arrow turns red and the text appears next to the Viewing Window.

4. Modify the text as necessary.
5. Click **Apply** to save changes to your title.

Changing text properties

You can change many text properties within a title.

Changes affect the entire text field.

1. Select the Title Tool clicking the  **Title Tool** button.
2. Select the text you want to modify.

The selected text appears next to the Viewing Window.

3. Change any of the following as necessary:
 - Font--Select a font from the drop-down menu
 - Size--Enter a new font size or click the arrows to change the size
 - Style--Click the buttons for Bold, Italic, or Underline
 - Alignment--Select Align Text Left, Center, Right, or Justify Text
 - Color--Click the color button, select the new color, and click **OK**
4. Click **Apply** to save changes to your title.

Changing edge properties

Using the Lyric Plug-in, you can modify a text field's edge properties, which creates a drop shadow on the right edge of each character in the text field.

1. Select the Title Tool by clicking the  **Title Tool** button.
2. Select the text field.

The selected text appears next to the Viewing Window.

3. To change the size, transparency, or softness of the character edge, enter new values by typing or using the arrows to change values.

4. To change the color of the character edge, click the color button and select a new color.
5. Click **Apply** to save these changes to your title.

Edge property parameters

These options affect the right edge of each character in the selected text field.

Option	Range	Description
Size	0-100	0 is not visible at all and 100 is the full size of the edge.
Transparency	0-100	0 is fully opaque and 100 is fully transparent.
Softness	0-99	0 is no softness and 99 is the full softness available for the edge of the text.

This table shows each of the edge characteristics using different values:

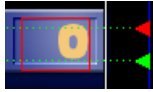
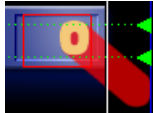
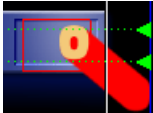
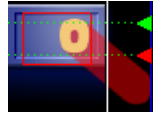
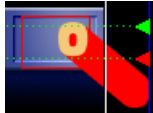
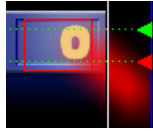
Edge Characteristic	Lowest Value = 0	Highest Value = 100
Size		
Transparency		
Softness		

Advanced titling

To create a new template or extensively edit an existing one, you use the Title Tool's Advanced Mode, which launches the Chyron Lyric plug-in.

1. Click the  **Advanced Mode** button in the Title Tool.
The Chyron Lyric plug-in appears.
2. Make changes to the current title or create a new one.

For detailed instructions, see the Lyric online help under **Help | Help Topics**, or see the Chyron documentation.

3. If you made changes to any of the tabs in the Properties window, click **Apply**.

Changes made directly on the Lyric Canvas display in the Title Tool automatically.

4. Close the window.
5. Click **Apply** in the Title Tool to apply the title changes to the Timeline.

Related Links

[*Modifying a template for your sequence*](#)

Adding fonts

The Chyron Lyric CD-ROM includes additional fonts you can use to provide greater text variety in your titles.

Adding many additional fonts may slow the application down, so add only the fonts you need.

1. Insert the Chyron Bitstream Fonts CD into the CD-ROM drive,
2. From the Windows Start menu, select **Settings | Control Panel | Fonts**.
3. From the File menu, select **Install New Font**.
4. In Drives, select your CD-ROM drive.
5. In Folders, double-click the **FONTS** folder.
6. In List of fonts, click the font you want to add.

To select multiple fonts, hold down the Ctrl key and click each font to add.

7. Click **OK**.

The Orad Graphics Tool

The optional Orad Maestro Graphics tool is available with the Aurora Edit and Aurora Edit LD systems for providing animated and still graphics in an end-to-end workflow from the journalist desktop to playout on air.

The Orad Graphics tool is a high-end software/hardware solution that is capable of both 2D and 3D animations and stills. In addition, the graphics department has the ability to create simple templates for use by journalists and editors later in the workflow.

From the journalist desktop, Orad has a standard plug-in that allows operators to access, add, or modify graphics that can then be linked to Orad scripts as MOS objects.

From Aurora Edit, editors can link to scripts by creating a new sequence and linking to the Assignment List Manager to select a story. Then from the Story View, graphics

can be copied directly to the Graphics track on the Timeline. Graphics that get copied to the Timeline will inherit the default graphic duration, which is configured in Aurora Edit's **Tools | Options | Graphics** tab in the main menu bar.

Once a graphic is on the Timeline Graphics track, it can be trimmed or extended. This will not change the path the animation will take. It will extend or trim the middle of the graphic.

Orad graphics placed on the Timeline Graphics track can be played directly to playout or previewed and edited by double-clicking on the graphic in the Timeline.

Double-clicking on the graphic allows the editor to make changes and run the graphic to preview it.

NOTE: *As an additional precaution, editors will not be able to trim the graphic beyond its minimum duration, which is determined by the keyframes within the animation.*

Refer to the Orad documentation included with your Orad system for complete details for using the Orad plug-in and other Orad features.

Related Links

[Linking to an existing news or sports story](#) on page 101

Configuring Orad in Aurora Edit

Before using the Orad graphics system, a number of settings must be configured for proper operation. These configuration settings are normally made during installation. You can check these settings from your Aurora Edit or Aurora Edit LD application to make sure they have been set properly.

During installation, the following items must be configured for proper Orad integration and operation:

- Each client must have the correct Orad plug-in installed on their system in order to properly access and present graphics within Aurora Edit and Aurora Edit LD.

NOTE: *Refer to the Aurora Edit and Aurora Edit LD Release Notes for the correct plug-in version to use with this release.*

- A single AURORA-GFX site license must reside in the location of the configured License Server dialog box within the **Tools | Options | General** tab in the top menu bar of the Aurora Edit application.
- When the Aurora Edit application launches, it checks the license server location for the presence of the AURORA-GFX license.

NOTE: *In the unlikely event that multiple editors launch at the exact same time and try to access the license, one of the clients will be denied access.*



- In the **Tools | Options | Graphics** tab, the Orad selection must be active in the pulldown and the **Enable MOS workflow** checkbox must be checked. This allows Aurora Edit to link to the script and copy graphics to the Timeline.

- The **Graphic MOS ID** field must match the currently configured Orad MOS ID that is found in the newsroom computer system.
- The **Initial Duration** field is provided for when a graphic is saved to the Timeline and no mark in or mark out has been set for the graphic, it will default to the duration set here.
- The **Play Out** duration is the command from Orad telling when a graphic is on-air and it has an animation to come off the screen this is the typical duration. Every animation will have a play in and a play out. The play in is known (by the Initial duration) and the play out is determined by the Graphics department.

Refer to the *Aurora Edit and Aurora Edit LD Installation Manual* and the *Aurora Edit and Aurora Edit LD Release Notes* and for more detailed instructions for installing and configuring this option.

Moving Orad MOS objects into Aurora Edit

Once a graphic object in Orad has been saved and tagged to a story, it becomes a MOS object available for integration into Aurora Edit. This is done by linking to the story through a new sequence created in Aurora Edit.

1. To link to the story, create a new sequence in Aurora Edit by selecting the  **New Sequence** button in the Bin Contents toolbar.
2. In the New Sequence window, select the  **Link to Story** button at the top left.
This will bring up the Aurora Edit Assignment List Manager (ALM).
3. From the Assignment List, select the story you are editing and click **OK** to close the Assignment List.

The story name gets appended to the sequence title and a unique ID is assigned from the news service. Click **OK** to close the sequence and open the Timeline.

4. Once the Timeline is open, you can preview the script and retrieve the MOS object by selecting the  **Story View** button in the top right main menu bar.

The Story View view opens listing the stories created in Orad. MOS objects appear on the left side of the list in red .

5. At the top of the Story View window is a  **Copy to Timeline** button. Select it to move the MOS object onto the open Timeline Graphics track.

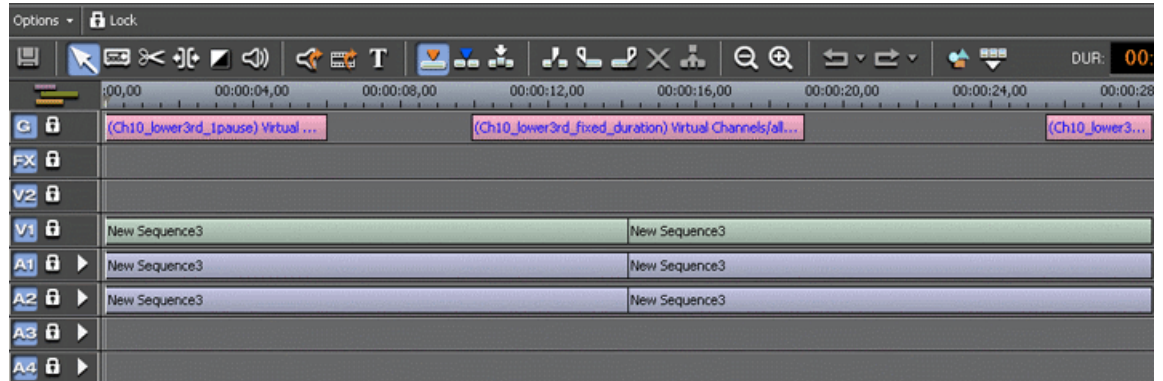

NOTE: Multiple MOS objects can be present in the script and all will be copied to the Timeline at the same time.

6. The MOS object(s) can pass directly to playout without previewing or they can be previewed (by double-clicking on the Orad graphic to bring up the Orad preview window) and edited if required.

Related Links

[Story View functions](#) on page 103

Creating Graphics In Orad

The first step in integrating Orad graphics within the Aurora Edit Timeline is for the journalist to create a graphic in Orad using a standard Orad plug-in that embeds in both iNews and ENPS.

1. From within Orad, the journalist pulls up the standard Orad plug-in where they can navigate through the tools to create the desired graphic from a template created by the graphics department.

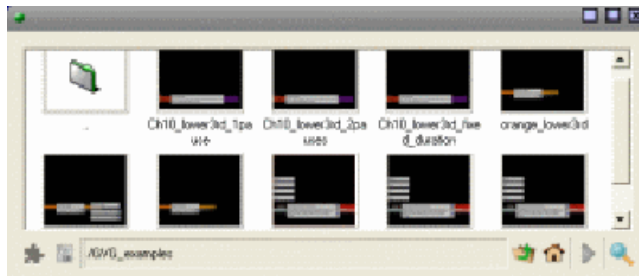

2. Once the journalist has edited the graphic object as desired, the graphic is saved within Orad.

At this point the drag and drop item becomes active and the journalist drags and drops the graphic over into the script, tagging the graphic to the story. Once an

object is tagged to a story it becomes available as a MOS object to the editor and can be recalled and dragged to the Aurora Edit Timeline.

Preview and Edit Orad Graphics

You can send the graphic(s) created in Orad and placed on the Timeline directly to playout with no changes or the editor can preview and edit the Orad graphic(s) placed on the Timeline before sending.

1. When the object is first copied to the Timeline it cannot be previewed, it is a reference only to a MOS object from Orad. You must double-click the graphic to open it.

The graphic opens as shown below.

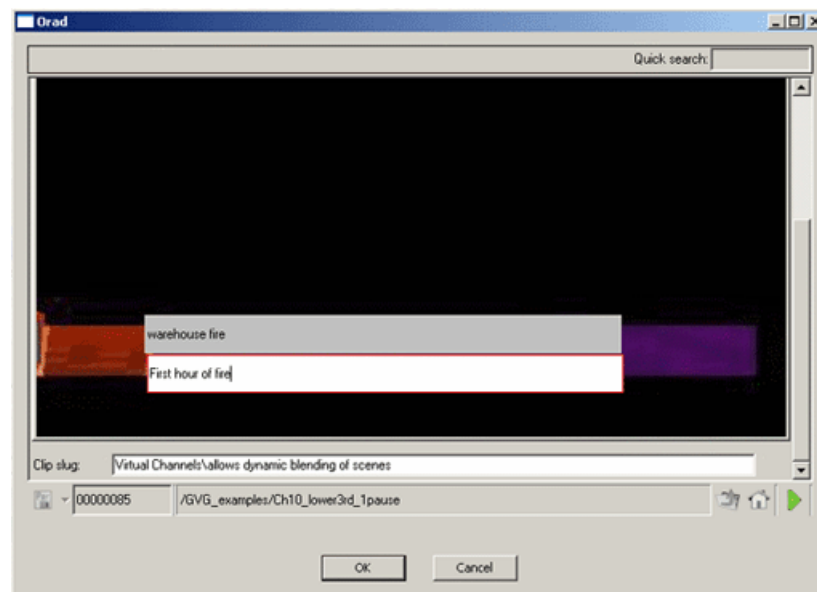

2. If changes are needed, make the changes to the text by selecting the text in the preview window. In this view the editor can make any desired text changes in the Orad plug-in.
3. You may then preview the entire graphic by playing it. Select the green arrow at the lower right of the screen.

As this graphic was created with a play in and play out duration which is standard operation, the editor must select the Play button twice, the first time to play in and the second to play out.

The entire graphic will play in a separate window as shown above.

4. If you are satisfied with the changes, select **OK** to save the graphic to the Timeline.

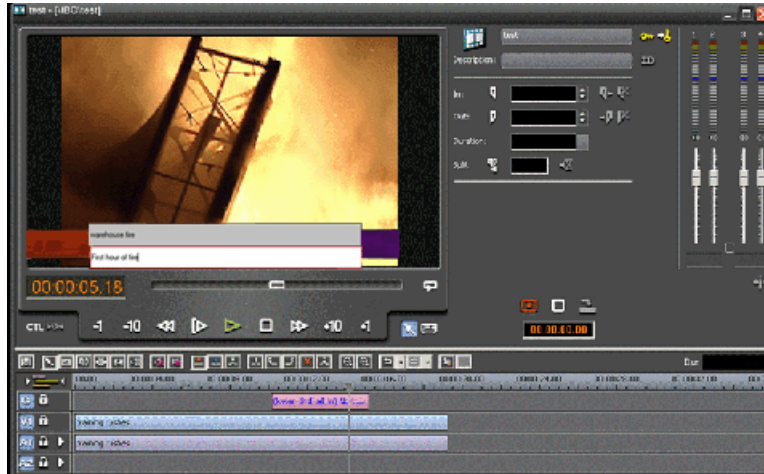

Once the story has been sent to Aurora Playout, the graphics that are embedded within the Timeline are communicated to Orad and Aurora Playout.

Related Links

The VizRT Graphics Tool

The optional VizRT Graphics tool is available with the Aurora Edit and Aurora Edit LD systems for providing integration of graphics from the journalist desktop to the Timeline Graphics track.

The VizRT Graphics tool is a high-end software/hardware solution that is capable of both 2D and 3D animations and stills. In addition, the graphics department has the ability to create simple templates for use by journalists and editors later in the workflow.

From the journalist desktop, VizRT has a standard plug-in that allows operators to access, add, or modify graphics that can then be linked to scripts as MOS objects.

From Aurora Edit, editors can link to scripts by creating a new sequence and accessing stories from the Assignment List Manager. They can then copy graphics directly to the Graphics track on the Timeline from the Story View. Once a graphic is retrieved (rendered) to the Timeline, it can be previewed and edited. Graphics that get copied to the Timeline will inherit the default graphic duration, which is configured in Aurora Edit's **Tools | Options | Graphics** tab in the main menu bar.

VizRT also allows the editor to access VizRT from within Aurora Edit or Aurora Edit LD to create a new graphic.

Graphics on the Timeline can be trimmed or extended. This will not change the path the animation will take. It will extend or trim the middle of the graphic.

NOTE: *As an additional precaution, editors can trim the graphic until it is no longer on the Timeline. There is no minimum duration.*

Refer to the VizRT documentation included with your VizRT system for complete details for using the VizRT plug-in and other VizRT features.

Related Links

[Linking to an existing news or sports story](#) on page 101

Configuring VizRT in Aurora Edit

Before using The VizRT graphics system, a number of settings must be configured for proper operation. These configuration settings are normally made during installation. You can check these settings from your Aurora Edit or Aurora Edit LD application to make sure they have been set properly.

During installation, the following items must be configured for proper VizRT integration and operation:

- Each client must have the correct VizRT plug-in installed on their system in order to properly access and present graphics within Aurora Edit and Aurora Edit LD.

NOTE: Refer to the Aurora Edit and Aurora Edit LD Release Notes for the correct plug-in version to use with this release.

- You must have set up the VizRT NLE Configuration Tool during installation of the plug-in and other required components or the configuration tool will open the first time you try to do a retrieval. If this occurs, refer to the *Aurora Edit and Edit LD Installation Manual* for a detailed overview of all setups required.
- A single AURORA-GFX site license must reside in the location of the configured License Server dialog box within the **Tools | Option | General** tab in the top menu bar of the Aurora Edit application.
- When the Aurora Edit application launches, it checks the license server location for the presence of the AURORA-GFX license.

NOTE: In the unlikely event that multiple editors launch at the exact same time and try to access the license, one of the clients will be denied access.

- In the **Tools | Option | Graphics** tab, the VizRT selection must be active in the pulldown and the **Enable MOS workflow** checkbox must be checked. This allows Aurora Edit to link to the script and copy graphics to the Timeline.
- The **Graphic MOS ID** field will fill in with the standard MOS ID from VizRT.
- The **Initial Duration** field is provided for when a graphic is saved to the Timeline and no mark in or mark out has been set for the graphic, it will default to the duration set here.
- The **Play Out** duration is the command from VizRT telling when a graphic is on-air and it has an animation to come off the screen this is the typical duration. Every animation will have a play in and a play out. The play in is known (by the Initial duration) and the play out is determined by the Graphics department.

Refer to the *Aurora Edit and Aurora Edit LD Installation Manual* and the *Aurora Edit and Aurora Edit LD Release Notes* for more detailed instructions for installing and configuring this option.

Configuring the VizRT NLE Configuration Tool

The first time you do a retrieval of a VizRT graphic from the VizRT system, a NLE Configuration Tool will need to be configured by the user.

If the VizRT Configuration Tool comes up the first time you try to retrieve a VizRT graphic, you will need to fill in the required fields and set the pulldowns to match your application. Check your VizRT documentation for more information on these settings. The settings given here are only examples and may differ for your application.

1. When the VizRT NLE Configuration Tool comes up, on the Advanced Settings page, select **All Settings** as the Settings view to see the example Setting page below.
2. In the Plugin user interface pulldown, select **Newsroom Component**.
3. In the Viz Engine network compression pulldown, select **RLE Compression**.
4. Check the box in the Viz Engine prefetching field.



Setting	Value
Plugin user interface	Newsroom Compoo
Plugin log level	None
Plugin log directory	
Plugin should log fields/frames	<input type="checkbox"/>
Plugin colour correction	none
Viz Engine host	wbrnd-turnertes:50007
Viz Engine network compression	RLE compression
Viz Engine prefetching	<input checked="" type="checkbox"/>
Viz Engine prefetch size	15
Viz Engine cache size	40
Viz Engine network timeout	45s
Viz Media Sequencer Engine host	wbrnd-turnertes:8594
Config tool options	
Config tool grace period	2s
Viz Trio NLE executable	trionle.exe
Viz Trio NLE Options	-mse MSE_HOST -vizpreview VIZ_HOST:50008 -logfile-path "LOG_PATH"
Viz Trio NLE network timeout	1m 30s
Viz Trio NLE grace period	2s
Viz Trio NLE shared folder	
Viz Trio NLE shared folder for Viz Eng	
Viz Trio NLE drive remappings	
Newsroom Component executable	VcpAxNle.exe
Newsroom Component options	-mse MSE_HOST -vizpreview VIZ_HOST:50008 -logfile-path "LOG_PATH"
Newsroom Component network timec	1m 30s
Newsroom Component grace period	0 ms
Viz NLE Editor executable	VizNleEditor.exe
Viz NLE Editor options	-mse MSE_HOST -vizpreview VIZ_HOST:50008 -logfile-path LOG_PATH
Viz NLE Editor network timeout	1m 30s
Viz NLE Editor grace period	2s

5. On the **General** page, you will need to make sure the Viz Render Engine and Port number are set correctly for your facility.

For more information on setting up the VizRT application for your facility refer to the *Aurora Edit and Aurora Edit LD Installation Guide* and the documentation included with your VizRT system.

Moving VizRT MOS objects into Aurora Edit

Once a graphic object in VizRT has been saved and tagged to a story, it becomes a MOS object available for integration into Aurora Edit. This is done by linking to the story in the Assignment List through a new sequence created in Aurora Edit and copying the graphic to the Timeline Graphics track from the Aurora Edit Story View.

1. To link to the story, create a new sequence in Aurora Edit by selecting the  **New Sequence** button in the Bin Contents toolbar.
2. In the New Sequence window, select the  **Link to Story** button at the top left.

This will bring up the Aurora Edit Assignment List.

3. From the Assignment List, select the story you are editing and click **OK**.

The story name gets appended to the sequence title and a unique ID is assigned from the news service. Click **OK** to close the sequence and open the Timeline.

4. Once the Timeline is open, you can view the script by selecting the  **Story View** button in the top left main menu bar.

The Story View view opens showing the story created in VizRT and selected in the Assignment List. MOS objects appear on the left side of the Story View in red .

5. At the top of the Story View window is a  **Copy to Timeline** button. Select it to move the MOS object(s) onto the open Timeline Graphics track. At this time, the object is still a MOS object and must be retrieved from the VizRT graphics system to be visible to the editor.

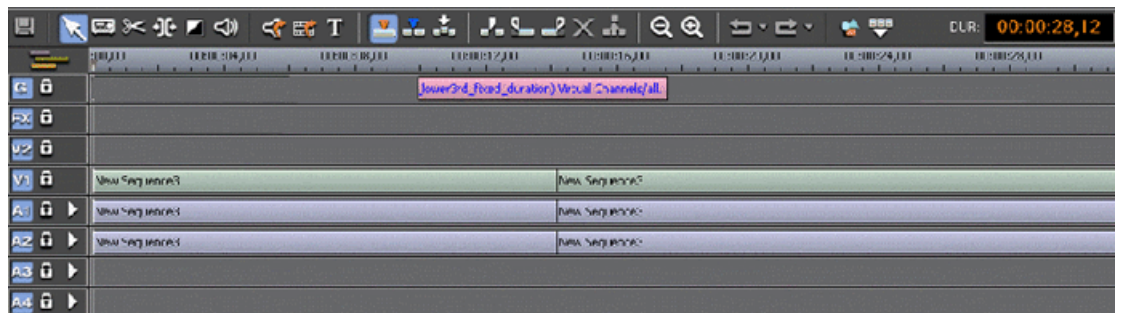

NOTE: Multiple MOS objects can be present in the script and all will be copied to the Timeline at the same time.

6. To retrieve the graphic(s), right-click on each graphic and select the **Retrieve Graphic** command from the pop-up menu.

This will bring up the **Importing Graphic** window which will show the progress of the graphic retrieving operation.

7. Once the graphic has been retrieved, the editor can play the graphic on the Timeline to preview it.

Aurora Edit LD will not be able to preview the graphic. In addition, it can only retrieve to bins that it has access to. The graphic will be rendered into the sequence by the conform server.

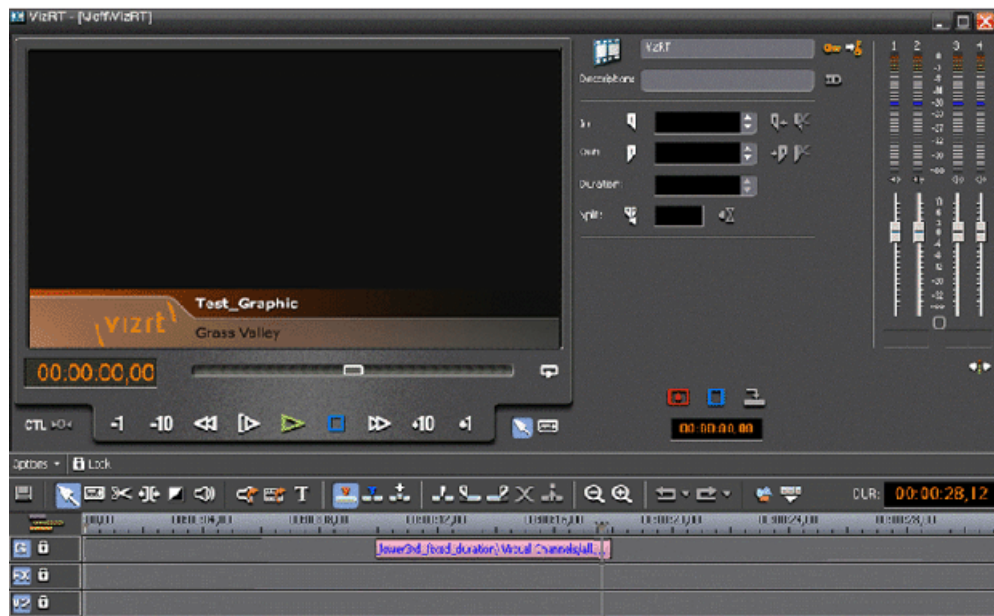

NOTE: *VizRT graphics may also be created by accessing the VizRT plug-in from within Aurora Edit or Aurora Edit LD as explained in another section.*

Related Links

[Story View functions](#) on page 103

Create VizRT Graphic within Aurora Edit

With the VizRT system, an editor can create a graphic by opening the VizRT plug-in from within Aurora Edit.

1. To create a new graphic from within the Aurora Edit or Aurora Edit LD application, right click on the Graphics track of the open Timeline and select the **New Graphic** command in the pop-up menu.

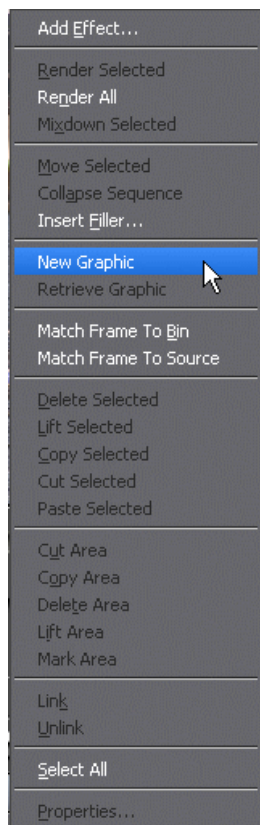

This will bring up the VizRT NLE plug-in where the editor has the same capabilities as the journalist to modify or create a new graphic. Once the graphic has been created, select the **Save As** button at the bottom of the plug-in.

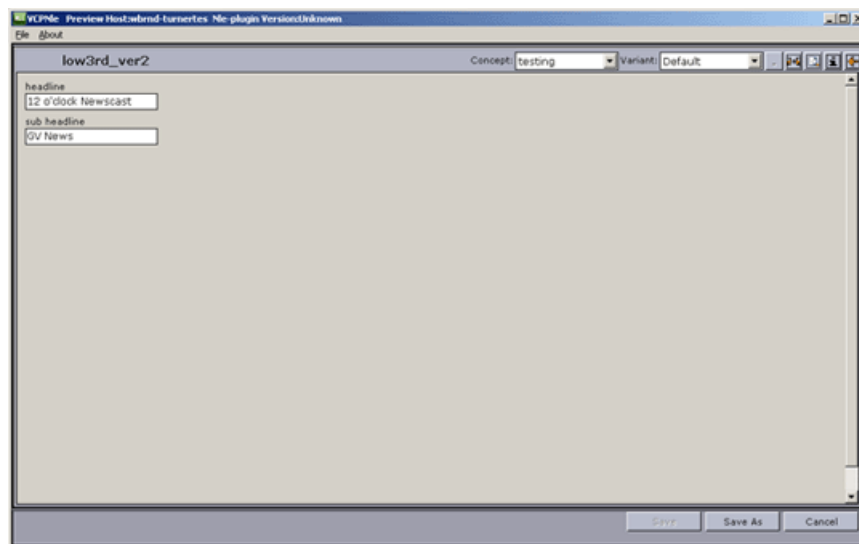

2. In the Save dialog, rename the graphic if you have modified an existing graphic or select **Save as new** and name the new graphic.

This commits the new graphic to the Timeline Graphics track where it remains a MOS object until retrieved by the editor.

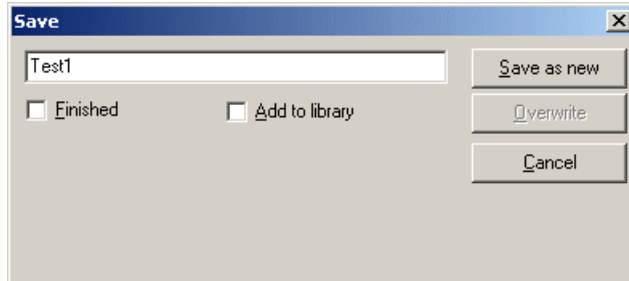

3. To retrieve the graphic, right-click on the graphic and select the **Retrieve Graphic** command from the pop-up menu.

This will bring up the **Importing Graphic** window which will show the progress of the graphic retrieving operation.

4. Once retrieved, the graphic can be previewed by moving the cursor over the graphic to play it on the Timeline.

Preview VizRT Graphics

Once the graphic has been retrieved to the Timeline Graphics track, the editor can preview the graphic.

1. Preview the VizRT graphic after retrieving it to the Timeline by moving the Timeline cursor over the graphic.

The graphic opens as shown below.

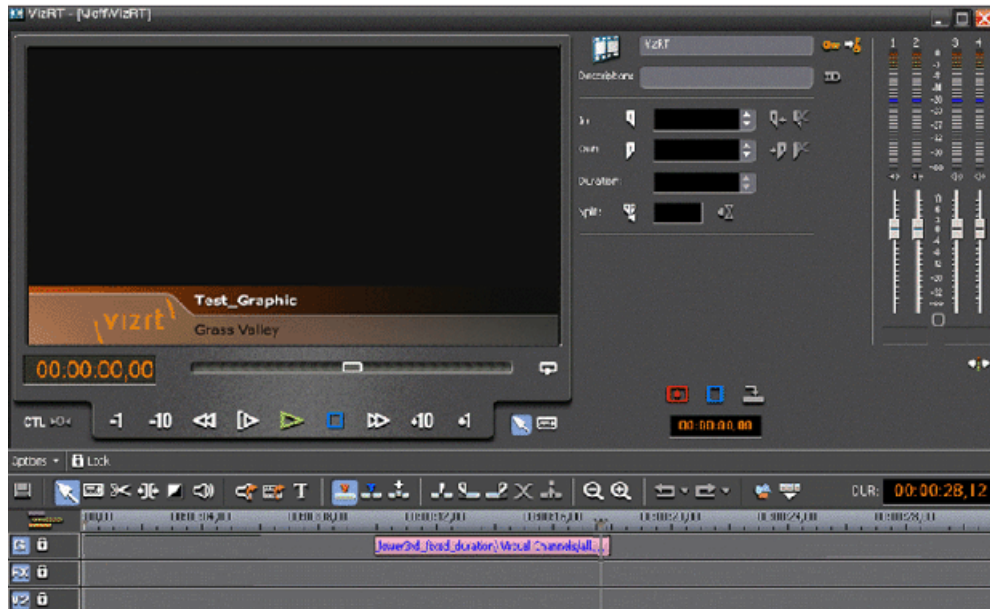

2. You can change the duration at any point, including cutting the graphic.

Changing the duration does not change the behavior of the graphic. The graphic has a play in and a play out and everything in between will be animated on-air according to the duration defined for this graphic.

NOTE: *Be aware that there is no minimum duration defined for a VizRT graphic. You could trim the graphic short enough so you would never see the graphic play out.*

3. You may also preview the graphic with your video after your entire sequence has been edited and rendered.

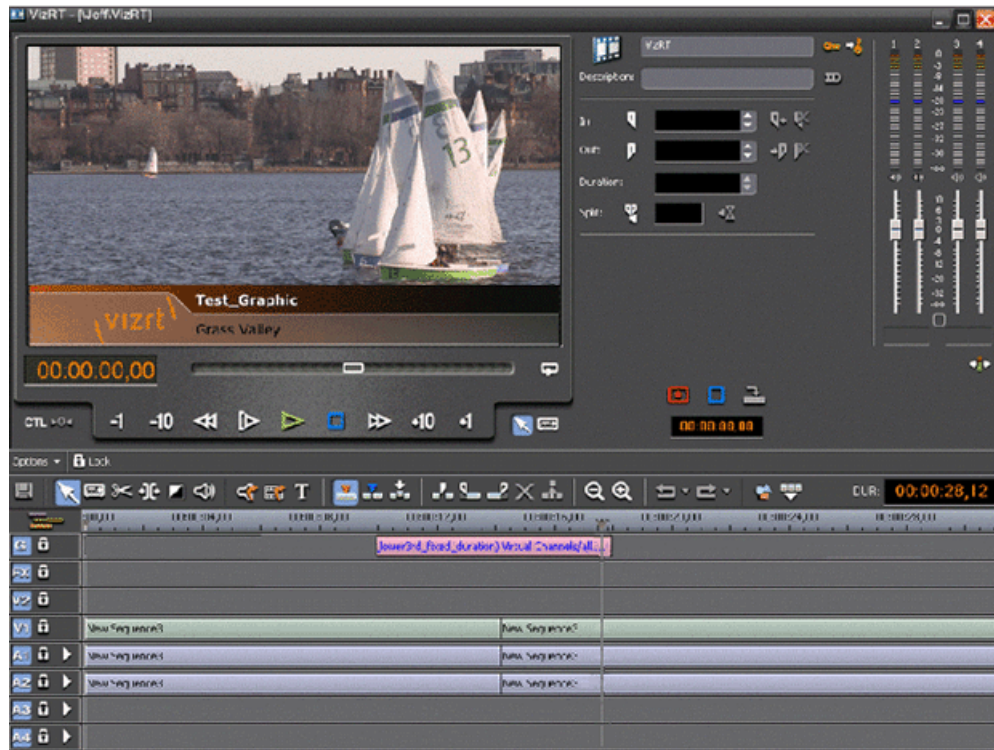

The VizRT graphics are burned into the Timeline sequence and sent to play out with the Timeline.

Chapter **13**

Sending and exporting output

This section contains the following topics:

- *Sending sequences*
- *Associating a sequence with an Aurora Playout placeholder*
- *Recording completed sequences to tape*
- *Storing sequences on Aurora Edit*
- *Creating a playback list*
- *Exporting files*
- *Using the Conform Manager*

Sending sequences

Sending your completed sequences to a playback server is the most common way to use Aurora Edit. You can also send your sequences to another Aurora Edit workstation or to a network server.

If you have a K2 Media Client or M-Series iVDR, you can send your sequences to the server for almost instant playback to air. Once you establish a network between the media server and other Aurora Edit workstations, you can send clips and sequences to other Aurora Edit workstations as well as the media server.

1. Go to the Bin and highlight the sequence you wish to send by clicking on the sequence title.

If the sequence is open on the Timeline, you don't need to go to the Bin.

2. Press **F2** on the keyboard or click the  **Send To File** button in the toolbar.

The Select Destination window appears, showing all available locations.

3. Click on the box where you want to send the sequence.

You can use the Video ID of a sequence instead of the sequence name by selecting the **Use Video ID** box in the Select Destination window. If no Video ID appears with the sequence, that box is grayed out.

4. If you want to change the name of the sequence, enter it in the **Send As:** field.

You cannot change the **Send Type** field.

5. Click **Send** or press **Enter** on the keyboard to send your sequence.

Associating a sequence with an Aurora Playout placeholder

If you create a clip or sequence on Aurora Edit for a specific placeholder in Aurora Playout, you need to send it back to a playout Media Server so it can be played to air.

1. Select the completed sequence in the Aurora Edit Bin.

If you have the completed sequence open in Aurora Edit, it is already selected.

2. Press **F2** on the keyboard or click the  **Send To File** button in the toolbar.

The Send To Selected Destinations window appears, displaying the list of open Aurora Playout placeholders.

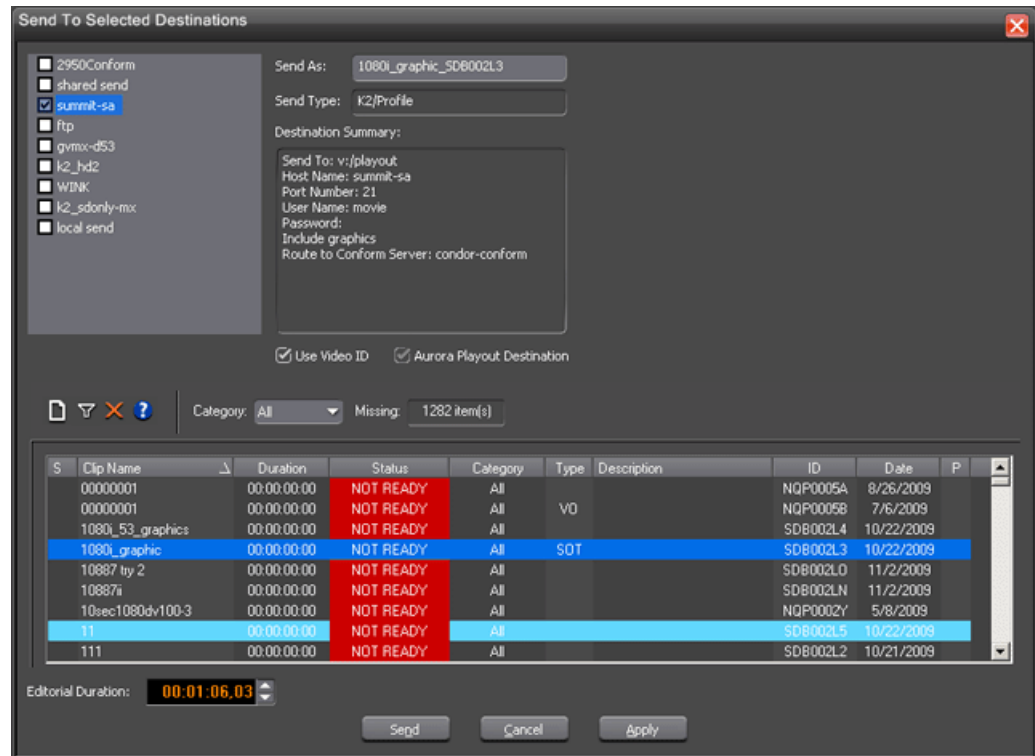

3. Select the placeholder to assign to your completed sequence.

If the sequence was already linked to a story or placeholder, the window automatically selects the Aurora Playout placeholder.

4. Enter a **Duration** for the sequence, if desired.

When sending a linked story to an Aurora Playout destination, you have the opportunity to change the Editorial Duration. The duration is sent back to the Newsroom Computer System as the actual on-air duration of the sequence for more accurate rundown timing. If left unchanged, the total duration of the story is sent by default.

5. Click **Send**.

The clip is automatically sent to the Media Server. Once the clip is sent, the placeholder no longer appears in your Assignment List and the number of missing items at the top of the screen decreases by one.

Recording completed sequences to tape

You can record your sequences to tape. Use this to archive stories or provide a copy of a story to others not using Aurora Edit.

Make sure that you have rendered all effects before recording a sequence to tape; non-rendered effects don't record and won't be visible on the tape.

1. Save your sequence and close it.
2. Cue your record tape to an appropriate recording spot.

Click the  **Record To Bin** button and play the tape to determine an appropriate spot to start recording.

3. Highlight the sequence you wish to record by clicking the sequence title in the Bin window.
4. Click the  **Play to Tape** button in the main toolbar.

The Play To Tape window appears.

5. Click the **Settings** button and verify settings in the Play Settings window.
6. Select an edit mode for the record:
 - **Insert Edit**--Records new material at an intermediate point of an existing recording, using the existing timecode. You can send individual tracks to the tape as well.
 - **Assemble Edit**--Records new material at the end of a pre-recorded section of the tape, changing the timecode.
 - **Crash Record**--Initiates a record without using the auto-edit function, eliminating the need for preroll; results in a record that doesn't have a frame-accurate start position.

The Insert and Assemble Edit modes work only with decks that have Auto-Edit functions. Check your tape deck's user manual to determine if it supports this feature.

7. Mark an In point.

The timecode of the record tape shows up at the Mark In point.

8. Press **F12** on the keyboard, or click the **Record** button, to start recording.

After the sequence is done recording, the deck will stop.

9. Close the Play To Tape window.

You can review your recorded story on tape by clicking the  **Record To Bin** button in the main toolbar.

Related Links

[Rendering video effects](#) on page 200

[Rendering transitions](#) on page 141

Storing sequences on Aurora Edit

Instead of sending your sequences to a playback server, you can save them on your Aurora Edit workstation to use later.

To save a completed sequence, you send it to a bin on the same computer you are using. You can then create master clips instead of saving the entire sequence and the clips it uses.

It is a good idea to create a bin specifically for holding stored sequences, such as HFR (Hold For Release).

1. Click once on the sequence title that you want to send.
2. Press **F2** or click the  **Send To File** button.

The Select Destination window appears, showing all available locations.

3. Click on the box for your system.
4. Click **Send** to send your sequence.

Your sequence archives as a single clip.

Related Links

[Options—Send](#)

Creating a playback list

You can use Aurora Edit's playback list feature to back up your primary playback server or to air stories from any edit bay.

Before you can open a Playback Channel, you need to close all open sequences and windows, except the Bins, which can remain open.

If you want to send sequences directly to air from Aurora Edit, you can create a playback list. Opening a Playback Channel lets you add completed sequences in order and save the compiled list of sequences as a Playback List.

1. Select **Channels | Open Playback Channel**.

The Playback Channel window appears.

2. Open the bin (or bins) where the sequences reside.
3. Highlight each sequence and drag it into the numbered slots in the Playback Channel window.
4. To save your playlist, click the  **Save Playlist** button, enter the name of the playlist and click **Save**.
5. Enter the name of the playlist and click **Save**.

















Related Links

[Importing media](#) on page 84

Playing and organizing sequences in the playback list

You can reorder, play, or trim the sequences in your playlist, as well as save playlists.

- Use the buttons to play or modify your playlist:

Icon	Description
	Moves the selected clip up in the playlist
	Moves the selected clip down in the playlist
	Lets you scrub down a clip
	Starts playing the selected clip in the playlist
	Stops playing the clip in the playlist
	Recues a clip in the playlist
	Cues the previous clip in the playlist
	Cues the next clip in the playlist
	Cues the selected clip in the playlist
	Loops playback of clips in the playlist
	After playback, cues the next clip in the playlist
	Opens the trimmer so you can trim clips
	Saves the playlist
	Lets you open a saved playlist
	Removes the selected clip in the playlist
	Allows you to view or hide the viewer window
	Shows all channels so you can adjust audio

Playing all sequences in the playback list

You can play through the sequences in your playback list, continuously looping the playlist.

1. Turn  **Loop Playback** off and  **Cue Next After Playback** on.

2. Press **Ctrl + Shift** on the keyboard and simultaneously click the  **Play** button on the screen.

The playlist plays continuously until you click the  **Stop** button.



Viewing footage while playing a sequence

You have the option of viewing footage while playing a sequence.

1. Click the  **Show/Hide Viewer** button.

The Playback Channel View window appears.

2. Select the size of the View window:

	View quarter size
	View half size
	View full size

To close the Playback Channel View window, click the  **Show/Hide Viewer** button again.

Trimming sequences in the playlist

You can trim sequences in the playlist without going back to the original sequence in the bin.

1. Highlight the sequence you want to trim.
2. Click the  **Trim** button in the Playback Channel window.

The Trimmer window appears.

3. Change the Mark In and Mark Out points for the clip.
4. Click **OK**.

Related Links

[Marking In and Out Points](#) on page 113

Loading a playlist

You can load a playlist into the Playback Channel in order to make changes or play to air.

1. In the Playback Channel window, click the  **Load Playlist** button.

The Load Playlist window appears.

2. Select the name of the playlist you want and click **Load**.

The playlist loads into the Playback Channel window.

Changing playback colors

Playlist colors indicate the status of sequences and can be modified to suit your needs.

1. Choose **Channels | Playlist Colors**.

The Playlist Colors window appears.

2. Click **Change** for the row color you wish to change.
3. Pick a new color and click **OK**.
4. Change other colors as necessary.
5. Click **OK**.

Modifying playback settings

Playback settings allow you to select the type of output for playback, as well as configure Genlock settings.

1. In the Playback Channel window, click the **Settings** button.

The Playback Settings window appears.

2. Modify settings as needed:

Tab	Option	Description
Output	None	Select your type of output for playback
	Hardware Output	
Genlock	Enable Genlock	Check to use Genlock for playback
	Use Defaults	Resets settings to default values
	Vertical Delay	Set these settings for your newsstation
	Horizontal Delay	
	Subcarrier Phase	

3. Click **OK**.

Exporting files

Aurora Edit can export EDLs, video effects, graphic files, media files, as well as export to a removable media device.

You can export a part of an Aurora Edit sequence to enhance it using other tools, such as advanced audio editing or graphics applications, to exchange files with other systems, or to save favorite effects.

Exporting EDLs

From the Bin, you can export your sequence into an EDL file, in these formats: AAF, OMF, or XML.

You can select to save the EDL with the media embedded or to consolidate the media and link to it. If you consolidate the media, Aurora Edit creates a .vmf directory containing the consolidated files.

1. Highlight the sequence or clip in the Bin you want to export.
2. Choose **File | Export | EDL**.

The Export EDL window appears.

3. Navigate to the folder where you want to export the EDL.
4. Select the Save as type: **AAF Files**, **OMF Files**, or **XML Files**.
5. Change any options (for AAF and OMF file types) by clicking the **Options** button.
6. Enter a name for the file and click **Save**.

Related Links

[Importing EDL files](#) on page 82

[Enhancing audio using OMF files](#) on page 159

Options for exporting EDLs

You have different options available depending on the type of EDL you are exporting:

Export Type	Options	Description
AAF Files	Consolidate and embed media	First consolidates and then embeds the media in the AAF file. NOTE: Aurora Edit cannot create a consolidated file larger than 2 GB.
	Link to current media	Exports an AAF composition with links to the media in its current location. Media is not embedded in the file.
	Copy media and link to copied media	Copies media to another location and exports an AAF composition with links to the copied media.
	Consolidate media and link to consolidated media	Consolidates the media to another location and exports an AAF composition with links to the consolidated

media.Consolidate and embed are the default settings.

If you selected an option that includes copying or consolidating the media, click Set Export Path and select where the copied or consolidated files are saved.

OMF Files	Media Options	Consolidated Media	Exports the actual Timeline length, with the export handle length included. This option has a faster transfer time.This is the default setting.
		Full Media	The entire clip is maintained, including footage that has been trimmed. This option requires a longer transfer time, but provides you with extra handle material.
Compatibility		Pro Tools	Select which post-production audio tool you are using.
		Nuendo	
		Fairlight	

Exporting a Final Cut Pro EDL

With Aurora Edit, you can bring sequences into Apple's Final Cut Pro application for additional editing and refinement.

Aurora Edit supports these formats for exporting as a Final Cut Pro EDL:DV25, DV50, DV100, XDCAM, and LGOP

Files are transferred using Aurora Edit's XML EDL format and Apple's XML interchange format. These components of the sequence are transferred:

- Clips
- Rendered effects and titles
- Dissolves (other wipes are converted to a dissolve)
- Varispeed
- Fit To Fill
- Audio voice disguise (but not EQ)

1. Choose **File | Export | Final Cut Pro EDL**.

The Export Final Cut Pro EDL window opens.

2. In the **Save in:** drop-down list, select the location where you want to export the files.
3. Name the sequence you are exporting.
4. Click **Save**.

The sequence saves as an .XML file.

You can now import this XML file into Apple's Final Cut Pro application for further refinement and editing.

Exporting effects

You can export your favorite video effects and save them separately from your Aurora Edit sequence. Exported effects files are saved with a .vef extension.

1. Select the effect you want to export:
 - Open the sequence that includes the effect in the Timeline
 - Highlight the effect in the Bin
2. Choose **File | Export | Effect**.
3. Navigate to the folder where you want to export the effect.
4. Enter a name for the file and click **Save**.

Exporting graphic files

You can export a graphic file from Aurora Edit.

A graphic file is a thumbnail of the video in the Timeline at the cursor point when the file is exported. Exported graphic files can be sent to your graphics department for tweaking and enhancement; you can import the enhanced graphic back into your sequence.

1. Open a sequence in the Timeline and place the cursor over the video that you'd like to export as a graphic.
2. Choose **File | Export | Graphic**; the Export Graphic window appears.
3. Navigate to the folder where you want to export the graphic.
4. Enter a name for the file.
5. Select the type of file to export and click **Save**.

Exported graphic formats

You can export to these graphic file types:

Windows Bitmap	.bmp
Truevision Targa	.tga
JPEG-JFIF Compliant	.jpg, .jpeg
Tagged Image File Format	.tif, .tiff
Photoshop	.psd
Macintosh PICT	.pct
Zsoft Paintbrush	.pcx
Graphics Interchange Format	.gif

Exporting media

You can export a sequence from Aurora Edit for many reasons, including exchanging sequences with other editing systems, obtaining video to stream it on the web, and archiving video.

1. Select the sequence you want to export by opening it in the Timeline or highlighting it in the Bin.
2. Choose **File | Export | Media**.
The Export Media window appears.
3. Navigate to the folder where you want to export the file.
4. Select the type of file to export.
5. Choose the appropriate format: 480i (SD), 720p (HD), 1080i (HD).
6. Change any options by clicking the **Options** button.
7. Click **Save**.

Exported media formats

Aurora Edit supports these file types to export:

AVI Files	.avi
MPG Files	.mpg
WM9 Files	.asf
MOV Files	.mov
WM Audio Files	.wma
WAV Audio Files	.wav
AIF Audio Files	.aif
GXF Files	.gxf
MXF Files	.mxf

Options for exporting media

You have different options available to you depending on the type of media file you are exporting:

Media Format	Option	Description
WM9 or WM audio file	System	Select the profile that is most appropriate for your network.
	User Defined	
	Aurora Edit	

Media Format	Option		Description	
AVI or MOV file	General	Compression	DV25, DV50, MPEG2, Uncompressed	
		Tracks	Video and Audio; Video only	
		Field Order	Top First; Bottom First	
	Video Settings (can't change all settings for some compression types)	Bit Rate (Mbps)		Enter the desired bit rate.
		Chroma Format		4:2:2 or 4:2:0
		Video Resolution		720x512, 720x480
		Aspect Ratio		4:3 or 16:9 (can't change for MPEG2)
		Aspect Ratio Option		16:9 -- Pillar Box, Half Pillar Box, Zoom, Stretch 4:3 -- Letter Box, Half Letter Box, Crop, Compress
	MPEG file	Type		MPEG1, MPEG2, IMX
		Bitrate	Constant	Select the Rate or Average Mbps
Variable				
GOP Structure		I Frames	Adjust the configuration to select your GOP structure	
		P Frames		
		Structure		
Video Settings		Video Aspect		4:3 or 16:9
		Aspect Ratio Option		16:9 -- Pillar Box, Half Pillar Box, Zoom, Stretch
			4:3 -- Letter Box, Half Letter Box, Crop, Compress	
	Chroma Format		4:2:2 or 4:2:0	
	Field Order		Top First; Bottom First	

Exporting to a removable media device

With Aurora Edit (SD only) you can export files to an XDCAM removable media disk, in the native XDCAM format, FAM mode.

In order for your files to export correctly to your XDCAM disk, the Aurora Edit sequence needs to have the exact properties, such as video format, as the XDCAM device.

1. Choose **File | Export | Removable Media**.

The Export to Removable Media window opens.

2. In the **Look In** drop-down list, select your removable media device.
3. Click **Save**.

The Export Media window displays showing export progress.

Once written back to the XDCAM disk, the newly created asset is playable within XDCAM and it will display in the removable media bin of Aurora Edit and the removable media device as an item that you can import as if it were originally created from Sony.

Using the Conform Manager

The Aurora Edit Conform Manager tracks the status of EDL files sent to a specified Conform Server, allowing you to quickly monitor multiple Conform Servers and their current job queue.

Once an item is in the queue, you can stop the current job if you need to reprioritize or re-edit a sequence. You can also filter the jobs that display in the Conform Manager, letting you see only those jobs you need to monitor.

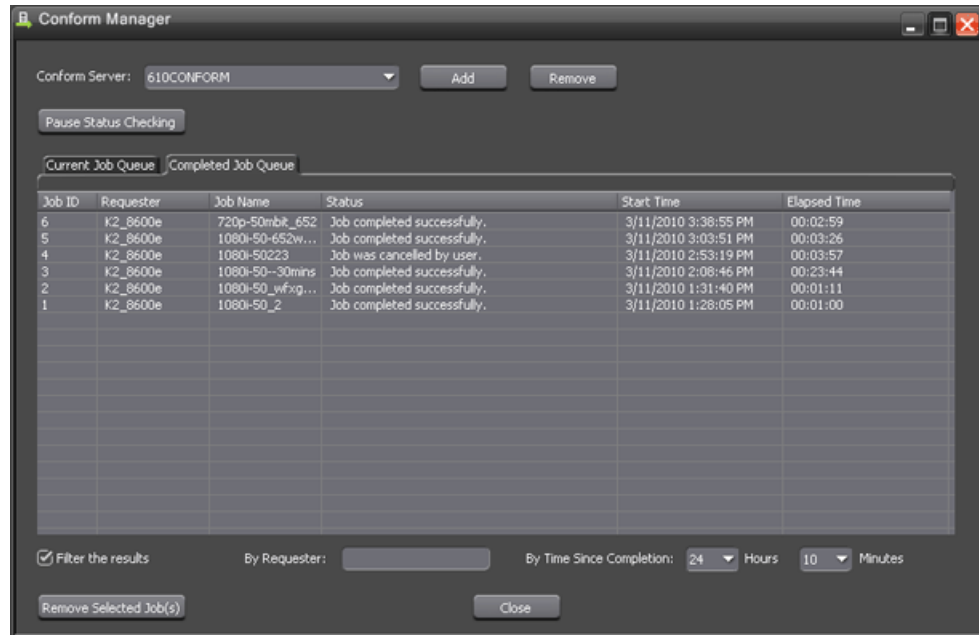

1. In the Aurora Edit main toolbar, click the  **Conform Manager** button.
The Conform Manager opens.
2. Click the Current Job Queue or Completed Job Queue tabs to view and control the progress of sent EDL files.

Field or button	Description
Conform Server	A drop-down list of the Conform Servers available to you at your location
Add	Lets you add a Conform Server to the Conform Manager
Remove	Lets you remove a Conform Server from the Conform Manager
Stop/Continue	Stops or pauses the dynamic updates of the Conform Manager; it has no impact on the Conform server itself
Job ID	The Conform Manager assigns a unique ID to each job that comes in; each job increments the ID by one
Requester	Name of the machine that sent the job
Job Name	Name of the clip as sent to the Conform Server
Status	Gives updated status on the completion of a job; status messages include "Job completed successfully", "Job failed"; failure messages may provide information on some functions
Start Time	Indicates when the job began conforming
Percent Complete	On the Current Job Queue tab, specifies what percentage of the job has completed; updates automatically
Elapsed Time	On the Completed Job Queue tab, specifies how long the job took
Filter the results	Lets you define what jobs to view; you can filter by Requester or by Time Since Completion, specified in hours and minutes
Stop Selected Job(s)	Click to stop conforming jobs you have selected
Close	Click to exit out of the Conform Manager

Software Licenses

This section contains the following topics:

- *cmemdc*
- *cping*
- *CSizingToolBar*
- *CTextProgressCtrl*
- *MIT*
- *mozilla*
- *Paintlib*
- *resizeable lib*
- *tconvert*
- *zlib*

cmemdc

License

You may freely use or modify this code provided this Copyright is included in all derived versions. See below.

CMemDC - memory DC

/Author: Keith Rule

Email: keithr@europa.com

Copyright 1996-2002, Keith Rule

You may freely use or modify this code provided this Copyright is included in all derived versions.

History

10/3/97 Fixed scrolling bug. Added print support. - KR

11/3/99 Fixed most common complaint. Added background color fill. - KR

11/3/99 Added support for mapping modes other than MM_TEXT as suggested by Lee Sang Hun. - KR

02/11/02 Added support for CScrollView as supplied by Gary Kirkham. - KR

This class implements a memory Device Context which allows flicker free drawing.

cping

License

Copyright

- You are allowed to include the source code in any product (commercial, shareware, freeware or otherwise) when your product is released in binary form.
- You are allowed to modify the source code in any way you want except you cannot modify the copyright details at the top of each module.
- If you want to distribute source code with your application, then you are only allowed to distribute versions released by the author. This is to maintain a single distribution point for the source code.

CSizingToolBar

License

CSizingControlBar Version 2.43

Created: Jan 24, 1998 Last Modified: August 03, 2000

See the official site at www.datamekanix.com for documentation and the latest news.

Copyright (C) 1998-2000 by Cristi Posea. All rights reserved.

This code is free for personal and commercial use, providing this notice remains intact in the source files and all eventual changes are clearly marked with comments.

You must obtain the author's consent before you can include this code in a software library.

No warrantee of any kind, express or implied, is included with this software; use at your own risk, responsibility for damages (if any) to anyone resulting from the use of this software rests entirely with the user.

Send bug reports, bug fixes, enhancements, requests, flames, etc. to cristi@datamekanix.com or post them at the message board at the site.

The sources and a short version of the docs are also available at www.codeproject.com. Look for a "Docking Windows" section and check the version to be sure you get the latest one ;)

Hint: These classes are intended to be used as base classes. Do not simply add your code to these file - instead create a new class derived from one of CSizingControlBarXX classes and put there what you need. See CMyBar classes in the demo projects for examples.

Modify this file only to fix bugs, and don't forget to send me a copy.

Acknowledgements:

- Thanks to Harlan R. Seymour for his continuous support during development of this code.
- Thanks to Dundas Software for the opportunity to test this code on real-life applications.
- Some ideas for the gripper came from the CToolBarEx flat toolbar by Joerg Koenig. Thanks, Joerg!
- Thanks to Robert Wolpow for the code on which CDockContext based diagonal resizing is based.
- Thanks to the following people for various bug fixes and/or enhancements: Chris Maunder, Jakawan Ratiwanich, Udo Schaefer, Anatoly Ivasyuk, Peter Hauptmann.
- And, of course, many thanks to all of you who used this code, for the invaluable feedback I received.

CTextProgressCtrl

License

Written by Chris Maunder (chrismaunder@codeguru.com)

Copyright 1998.

Modified : 26/05/98 Jeremy Davis, jmd@jvf.co.uk

Added colour routines

TextProgressCtrl is a drop-in replacement for the standard CProgressCtrl that displays text in a progress control.

This code may be used in compiled form in any way you desire. This file may be redistributed by any means PROVIDING it is not sold for profit without the authors written consent, and providing that this notice and the authors name is included. If the source code in this file is used in any commercial application then an email to the me would be nice.

This file is provided "as is" with no expressed or implied warranty. The author accepts no liability if it causes any damage to your computer, causes your pet cat to fall ill, increases baldness or makes you car start emitting strange noises when you start it up.

Expect bugs.

Please use and enjoy. Please let me know of any bugs/mods/improvements that you have found/implemented and I will fix/incorporate them into this file.

Chris Maunder is the original author.

MIT

License

Copyright (c)

Permission is hereby granted, free of charge, to any person obtaining a copy of this software and associated documentation files (the "Software"), to deal in the Software without restriction, including without limitation the rights to use, copy, modify, merge, publish, distribute, sublicense, and/or sell copies of the Software, and to permit persons to whom the Software is furnished to do so, subject to the following conditions:

The above copyright notice and this permission notice shall be included in all copies or substantial portions of the Software.

THE SOFTWARE IS PROVIDED "AS IS", WITHOUT WARRANTY OF ANY KIND, EXPRESS OR IMPLIED, INCLUDING BUT NOT LIMITED TO THE WARRANTIES OF MERCHANTABILITY, FITNESS FOR A PARTICULAR PURPOSE AND NONINFRINGEMENT. IN NO EVENT SHALL THE AUTHORS OR COPYRIGHT HOLDERS BE LIABLE FOR ANY CLAIM, DAMAGES OR OTHER LIABILITY, WHETHER IN AN ACTION OF CONTRACT, TORT OR

OTHERWISE, ARISING FROM, OUT OF OR IN CONNECTION WITH THE SOFTWARE OR THE USE OR OTHER DEALINGS IN THE SOFTWARE.

mozilla

License

Mozilla Public License 1.1 (MPL 1.1)

1. Definitions.

1.0.1. "Commercial Use" means distribution or otherwise making the Covered Code available to a third party.

1.1. "Contributor" means each entity that creates or contributes to the creation of Modifications.

1.2. "Contributor Version" means the combination of the Original Code, prior Modifications used by a Contributor, and the Modifications made by that particular Contributor.

1.3. "Covered Code" means the Original Code or Modifications or the combination of the Original Code and Modifications, in each case including portions thereof.

1.4. "Electronic Distribution Mechanism" means a mechanism generally accepted in the software development community for the electronic transfer of data.

1.5. "Executable" means Covered Code in any form other than Source Code.

1.6. "Initial Developer" means the individual or entity identified as the Initial Developer in the Source Code notice required by **Exhibit A**.

1.7. "Larger Work" means a work which combines Covered Code or portions thereof with code not governed by the terms of this License.

1.8. "License" means this document.

1.8.1. "Licensable" means having the right to grant, to the maximum extent possible, whether at the time of the initial grant or subsequently acquired, any and all of the rights conveyed herein.

1.9. "Modifications" means any addition to or deletion from the substance or structure of either the Original Code or any previous Modifications. When Covered Code is released as a series of files, a Modification is:

A. Any addition to or deletion from the contents of a file containing Original Code or previous Modifications.

B. Any new file that contains any part of the Original Code or previous Modifications.

1.10. "Original Code" means Source Code of computer software code which is described in the Source Code notice required by **Exhibit A** as Original Code, and which, at the time of its release under this License is not already Covered Code governed by this License.

1.10.1. "Patent Claims" means any patent claim(s), now owned or hereafter acquired, including without limitation, method, process, and apparatus claims, in any patent Licensable by grantor.

1.11. "Source Code" means the preferred form of the Covered Code for making modifications to it, including all modules it contains, plus any associated interface definition files, scripts used to control compilation and installation of an Executable, or source code differential comparisons against either the Original Code or another well

known, available Covered Code of the Contributor's choice. The Source Code can be in a compressed or archival form, provided the appropriate decompression or de-archiving software is widely available for no charge.

1.12. "You" (or "Your") means an individual or a legal entity exercising rights under, and complying with all of the terms of, this License or a future version of this License issued under Section 6.1. For legal entities, "You" includes any entity which controls, is controlled by, or is under common control with You. For purposes of this definition, "control" means (a) the power, direct or indirect, to cause the direction or management of such entity, whether by contract or otherwise, or (b) ownership of more than fifty percent (50%) of the outstanding shares or beneficial ownership of such entity.

2. Source Code License.

2.1. The Initial Developer Grant. The Initial Developer hereby grants You a world-wide, royalty-free, non-exclusive license, subject to third party intellectual property claims:

(a) under intellectual property rights (other than patent or trademark) Licensable by Initial Developer to use, reproduce, modify, display, perform, sublicense and distribute the Original Code (or portions thereof) with or without Modifications, and/or as part of a Larger Work; and

(b) under Patents Claims infringed by the making, using or selling of Original Code, to make, have made, use, practice, sell, and offer for sale, and/or otherwise dispose of the Original Code (or portions thereof).

(c) the licenses granted in this Section 2.1(a) and (b) are effective on the date Initial Developer first distributes Original Code under the terms of this License.

(d) Notwithstanding Section 2.1(b) above, no patent license is granted: 1) for code that You delete from the Original Code; 2) separate from the Original Code; or 3) for infringements caused by: i) the modification of the Original Code or ii) the combination of the Original Code with other software or devices.

2.2. Contributor Grant. Subject to third party intellectual property claims, each Contributor hereby grants You a world-wide, royalty-free, non-exclusive license

(a) under intellectual property rights (other than patent or trademark) Licensable by Contributor, to use, reproduce, modify, display, perform, sublicense and distribute the Modifications created by such Contributor (or portions thereof) either on an unmodified basis, with other Modifications, as Covered Code and/or as part of a Larger Work; and

(b) under Patent Claims infringed by the making, using, or selling of Modifications made by that Contributor either alone and/or in combination with its Contributor Version (or portions of such combination), to make, use, sell, offer for sale, have made, and/or otherwise dispose of: 1) Modifications made by that Contributor (or portions thereof); and 2) the combination of Modifications made by that Contributor with its Contributor Version (or portions of such combination).

(c) the licenses granted in Sections 2.2(a) and 2.2(b) are effective on the date Contributor first makes Commercial Use of the Covered Code.

(d) Notwithstanding Section 2.2(b) above, no patent license is granted: 1) for any code that Contributor has deleted from the Contributor Version; 2) separate from the Contributor Version; 3) for infringements caused by: i) third party modifications of Contributor Version or ii) the combination of Modifications made by that Contributor with other software (except as part of the Contributor Version) or other devices; or 4) under Patent Claims infringed by Covered Code in the absence of Modifications made by that Contributor.

3. Distribution Obligations.

3.1. Application of License.

The Modifications which You create or to which You contribute are governed by the terms of this License, including without limitation Section 2.2. The Source Code version of Covered Code may be distributed only under the terms of this License or a future version of this License released under Section 6.1, and You must include a copy of this License with every copy of the Source Code You distribute. You may not offer or impose any terms on any Source Code version that alters or restricts the applicable version of this License or the recipients' rights hereunder. However, You may include an additional document offering the additional rights described in Section 3.5.

3.2. Availability of Source Code.

Any Modification which You create or to which You contribute must be made available in Source Code form under the terms of this License either on the same media as an Executable version or via an accepted Electronic Distribution Mechanism to anyone to whom you made an Executable version available; and if made available via Electronic Distribution Mechanism, must remain available for at least twelve (12) months after the date it initially became available, or at least six (6) months after a subsequent version of that particular Modification has been made available to such recipients. You are responsible for ensuring that the Source Code version remains available even if the Electronic Distribution Mechanism is maintained by a third party.

3.3. Description of Modifications.

You must cause all Covered Code to which You contribute to contain a file documenting the changes You made to create that Covered Code and the date of any change. You must include a prominent statement that the Modification is derived, directly or indirectly, from Original Code provided by the Initial Developer and including the name of the Initial Developer in (a) the Source Code, and (b) in any notice in an Executable version or related documentation in which You describe the origin or ownership of the Covered Code.

3.4. Intellectual Property Matters

(a) Third Party Claims .

If Contributor has knowledge that a license under a third party's intellectual property rights is required to exercise the rights granted by such Contributor under Sections 2.1 or 2.2, Contributor must include a text file with the Source Code distribution titled "LEGAL" which describes the claim and the party making the claim in sufficient detail that a recipient will know whom to contact. If Contributor obtains such knowledge after the Modification is made available as described in Section 3.2, Contributor shall promptly modify the LEGAL file in all copies Contributor makes available thereafter and shall take other steps (such as notifying appropriate mailing lists or newsgroups) reasonably calculated to inform those who received the Covered Code that new knowledge has been obtained.

(b) Contributor APIs .

If Contributor's Modifications include an application programming interface and Contributor has knowledge of patent licenses which are reasonably necessary to implement that API, Contributor must also include this information in the LEGAL file.

(c) Representations.

Contributor represents that, except as disclosed pursuant to Section 3.4(a) above, Contributor believes that Contributor's Modifications are Contributor's original creation(s) and/or Contributor has sufficient rights to grant the rights conveyed by this License.

3.5. Required Notices.

You must duplicate the notice in **Exhibit A** in each file of the Source Code. If it is not possible to put such notice in a particular Source Code file due to its structure, then You must include such notice in a location (such as a relevant directory) where a user would be likely to look for such a notice. If You created one or more Modification(s) You may add your name as a Contributor to the notice described in **Exhibit A**. You must also duplicate this License in any documentation for the Source Code where You describe recipients' rights or ownership rights relating to Covered Code. You may choose to offer, and to charge a fee for, warranty, support, indemnity or liability obligations to one or more recipients of Covered Code. However, You may do so only on Your own behalf, and not on behalf of the Initial Developer or any Contributor. You must make it absolutely clear than any such warranty, support, indemnity or liability obligation is offered by You alone, and You hereby agree to indemnify the Initial Developer and every Contributor for any liability incurred by the Initial Developer or such Contributor as a result of warranty, support, indemnity or liability terms You offer.

3.6. Distribution of Executable Versions.

You may distribute Covered Code in Executable form only if the requirements of Section **3.1-3.5** have been met for that Covered Code, and if You include a notice stating that the Source Code version of the Covered Code is available under the terms of this License, including a description of how and where You have fulfilled the obligations of Section **3.2**. The notice must be conspicuously included in any notice in an Executable version, related documentation or collateral in which You describe recipients' rights relating to the Covered Code. You may distribute the Executable version of Covered Code or ownership rights under a license of Your choice, which may contain terms different from this License, provided that You are in compliance with the terms of this License and that the license for the Executable version does not attempt to limit or alter the recipient's rights in the Source Code version from the rights set forth in this License. If You distribute the Executable version under a different license You must make it absolutely clear that any terms which differ from this License are offered by You alone, not by the Initial Developer or any Contributor. You hereby agree to indemnify the Initial Developer and every Contributor for any liability incurred by the Initial Developer or such Contributor as a result of any such terms You offer.

3.7. Larger Works.

You may create a Larger Work by combining Covered Code with other code not governed by the terms of this License and distribute the Larger Work as a single product. In such a case, You must make sure the requirements of this License are fulfilled for the Covered Code.

4. Inability to Comply Due to Statute or Regulation.

If it is impossible for You to comply with any of the terms of this License with respect to some or all of the Covered Code due to statute, judicial order, or regulation then You must: (a) comply with the terms of this License to the maximum extent possible; and (b) describe the limitations and the code they affect. Such description must be included in the LEGAL file described in Section **3.4** and must be included with all distributions of the Source Code. Except to the extent prohibited by statute or regulation, such description must be sufficiently detailed for a recipient of ordinary skill to be able to understand it.

5. Application of this License.

This License applies to code to which the Initial Developer has attached the notice in **Exhibit A** and to related Covered Code.

6. Versions of the License.

6.1. New Versions.

Netscape Communications Corporation ("Netscape") may publish revised and/or new versions of the License from time to time. Each version will be given a distinguishing version number.

6.2. Effect of New Versions.

Once Covered Code has been published under a particular version of the License, You may always continue to use it under the terms of that version. You may also choose to use such Covered Code under the terms of any subsequent version of the License published by Netscape. No one other than Netscape has the right to modify the terms applicable to Covered Code created under this License.

6.3. Derivative Works.

If You create or use a modified version of this License (which you may only do in order to apply it to code which is not already Covered Code governed by this License), You must (a) rename Your license so that the phrases "Mozilla", "MOZILLAPL", "MOZPL", "Netscape", "MPL", "NPL" or any confusingly similar phrase do not appear in your license (except to note that your license differs from this License) and (b) otherwise make it clear that Your version of the license contains terms which differ from the Mozilla Public License and Netscape Public License. (Filling in the name of the Initial Developer, Original Code or Contributor in the notice described in **Exhibit A** shall not of themselves be deemed to be modifications of this License.)

7. DISCLAIMER OF WARRANTY.

COVERED CODE IS PROVIDED UNDER THIS LICENSE ON AN "AS IS" BASIS, WITHOUT WARRANTY OF ANY KIND, EITHER EXPRESSED OR IMPLIED, INCLUDING, WITHOUT LIMITATION, WARRANTIES THAT THE COVERED CODE IS FREE OF DEFECTS, MERCHANTABLE, FIT FOR A PARTICULAR PURPOSE OR NON-INFRINGEMENT. THE ENTIRE RISK AS TO THE QUALITY AND PERFORMANCE OF THE COVERED CODE IS WITH YOU. SHOULD ANY COVERED CODE PROVE DEFECTIVE IN ANY RESPECT, YOU (NOT THE INITIAL DEVELOPER OR ANY OTHER CONTRIBUTOR) ASSUME THE COST OF ANY NECESSARY SERVICING, REPAIR OR CORRECTION. THIS DISCLAIMER OF WARRANTY CONSTITUTES AN ESSENTIAL PART OF THIS LICENSE. NO USE OF ANY COVERED CODE IS AUTHORIZED HEREUNDER EXCEPT UNDER THIS DISCLAIMER.

8. TERMINATION.

8.1. This License and the rights granted hereunder will terminate automatically if You fail to comply with terms herein and fail to cure such breach within 30 days of becoming aware of the breach. All sublicenses to the Covered Code which are properly granted shall survive any termination of this License. Provisions which, by their nature, must remain in effect beyond the termination of this License shall survive.

8.2. If You initiate litigation by asserting a patent infringement claim (excluding declaratory judgment actions) against Initial Developer or a Contributor (the Initial Developer or Contributor against whom You file such action is referred to as "Participant") alleging that:

(a) such Participant's Contributor Version directly or indirectly infringes any patent, then any and all rights granted by such Participant to You under Sections 2.1 and/or 2.2 of this License shall, upon 60 days notice from Participant terminate prospectively, unless if within 60 days after receipt of notice You either: (i) agree in writing to pay Participant a mutually agreeable reasonable royalty for Your past and future use of Modifications made by such Participant, or (ii) withdraw Your litigation claim with respect to the Contributor Version against such Participant. If within 60 days of notice, a reasonable royalty and payment arrangement are not mutually agreed upon in writing by the parties or the litigation claim is not withdrawn, the rights granted by Participant to You under Sections 2.1 and/or 2.2 automatically terminate at the expiration of the 60 day notice period specified above.

(b) any software, hardware, or device, other than such Participant's Contributor Version, directly or indirectly infringes any patent, then any rights granted to You by such Participant under Sections 2.1(b) and 2.2(b) are revoked effective as of the date You first made, used, sold, distributed, or had made, Modifications made by that Participant.

8.3. If You assert a patent infringement claim against Participant alleging that such Participant's Contributor Version directly or indirectly infringes any patent where such claim is resolved (such as by license or settlement) prior to the initiation of patent infringement litigation, then the reasonable value of the licenses granted by such Participant under Sections 2.1 or 2.2 shall be taken into account in determining the amount or value of any payment or license.

8.4. In the event of termination under Sections 8.1 or 8.2 above, all end user license agreements (excluding distributors and resellers) which have been validly granted by You or any distributor hereunder prior to termination shall survive termination.

9. LIMITATION OF LIABILITY.

UNDER NO CIRCUMSTANCES AND UNDER NO LEGAL THEORY, WHETHER TORT (INCLUDING NEGLIGENCE), CONTRACT, OR OTHERWISE, SHALL YOU, THE INITIAL DEVELOPER, ANY OTHER CONTRIBUTOR, OR ANY DISTRIBUTOR OF COVERED CODE, OR ANY SUPPLIER OF ANY OF SUCH PARTIES, BE LIABLE TO ANY PERSON FOR ANY INDIRECT, SPECIAL, INCIDENTAL, OR CONSEQUENTIAL DAMAGES OF ANY CHARACTER INCLUDING, WITHOUT LIMITATION, DAMAGES FOR LOSS OF GOODWILL, WORK STOPPAGE, COMPUTER FAILURE OR MALFUNCTION, OR ANY AND ALL OTHER COMMERCIAL DAMAGES OR LOSSES, EVEN IF SUCH PARTY SHALL HAVE BEEN INFORMED OF THE POSSIBILITY OF SUCH DAMAGES. THIS LIMITATION OF LIABILITY SHALL NOT APPLY TO LIABILITY FOR DEATH OR PERSONAL INJURY RESULTING FROM SUCH PARTY'S NEGLIGENCE TO THE EXTENT APPLICABLE LAW PROHIBITS SUCH LIMITATION. SOME JURISDICTIONS DO NOT ALLOW THE EXCLUSION OR LIMITATION OF INCIDENTAL OR CONSEQUENTIAL DAMAGES, SO THIS EXCLUSION AND LIMITATION MAY NOT APPLY TO YOU.

10. U.S. GOVERNMENT END USERS.

The Covered Code is a "commercial item," as that term is defined in 48 C.F.R. 2.101 (Oct. 1995), consisting of "commercial computer software" and "commercial computer software documentation," as such terms are used in 48 C.F.R. 12.212 (Sept. 1995). Consistent with 48 C.F.R. 12.212 and 48 C.F.R. 227.7202-1 through 227.7202-4 (June 1995), all U.S. Government End Users acquire Covered Code with only those rights set forth herein.

11. MISCELLANEOUS.

This License represents the complete agreement concerning subject matter hereof. If any provision of this License is held to be unenforceable, such provision shall be reformed only to the extent necessary to make it enforceable. This License shall be governed by California law provisions (except to the extent applicable law, if any, provides otherwise), excluding its conflict-of-law provisions. With respect to disputes in which at least one party is a citizen of, or an entity chartered or registered to do business in the United States of America, any litigation relating to this License shall be subject to the jurisdiction of the Federal Courts of the Northern District of California, with venue lying in Santa Clara County, California, with the losing party responsible for costs, including without limitation, court costs and reasonable attorneys' fees and expenses. The application of the United Nations Convention on Contracts for the International Sale of Goods is expressly excluded. Any law or regulation which provides that the language of a contract shall be construed against the drafter shall not apply to this License.

12. RESPONSIBILITY FOR CLAIMS.

As between Initial Developer and the Contributors, each party is responsible for claims and damages arising, directly or indirectly, out of its utilization of rights under this License and You agree to work with Initial Developer and Contributors to distribute such responsibility on an equitable basis. Nothing herein is intended or shall be deemed to constitute any admission of liability.

13. MULTIPLE-LICENSED CODE.

Initial Developer may designate portions of the Covered Code as Multiple-Licensed. Multiple-Licensed means that the Initial Developer permits you to utilize portions of the Covered Code under Your choice of the NPL or the alternative licenses, if any, specified by the Initial Developer in the file described in Exhibit A.

EXHIBIT A -Mozilla Public License.

``The contents of this file are subject to the Mozilla Public License Version 1.1 (the "License"); you may not use this file except in compliance with the License. You may obtain a copy of the License at <http://www.mozilla.org/MPL/>

Software distributed under the License is distributed on an "AS IS" basis, WITHOUT WARRANTY OF ANY KIND, either express or implied. See the License for the specific language governing rights and limitations under the License.

The Original Code is _____.

The Initial Developer of the Original Code is _____. Portions created by _____ are Copyright (C) _____. All Rights Reserved.

Contributor(s): _____.

Alternatively, the contents of this file may be used under the terms of the _____ license (the [_____] License), in which case the provisions of [_____] License are applicable instead of those above. If you wish to allow use of your version of this file only under the terms of the [_____] License and not to allow others to use your version of this file under the MPL, indicate your decision by deleting the provisions above and replace them with the notice and other provisions required by the [_____] License. If you do not

delete the provisions above, a recipient may use your version of this file under either the MPL or the [____] License."

[NOTE: The text of this Exhibit A may differ slightly from the text of the notices in the Source Code files of the Original Code. You should use the text of this Exhibit A rather than the text found in the Original Code Source Code for Your Modifications.]

Paintlib

License

If you redistribute paintlib, you should redistribute the whole library including documentation and copyright. If that is not possible, you must make it clear that you're distributing a changed version. In no event may any part of the library be distributed without this copyright notice.

Before the legalese starts, here's the translation to plain english:

1. Do whatever you want with paintlib. Just don't come running to me with a lawyer if something goes wrong.
2. If you redistribute paintlib, you should redistribute the whole library including documentation and copyright. If that is not possible, you must make it clear that you're distributing a changed version. In no event may any part of the library be distributed without this copyright notice.
3. If you use paintlib in your program, you must acknowledge this, preferably in the about box and the documentation.

The legalese itself is a derivative work. I modified the LIBPNG copyright notice. Thanks, guys :-).

The paintlib source code and all documentation are copyright (c) 1996-1999 Ulrich von Zadow.

The paintlib source code is supplied "AS IS". Ulrich von Zadow and other authors disclaim all warranties, expressed or implied, including, without limitation, the warranties of merchantability and of fitness for any purpose. The authors assume no liability for direct, indirect, incidental, special, exemplary, or consequential damages, which may result from the use of paintlib, even if advised of the possibility of such damage.

Permission is hereby granted to use, copy, modify, and distribute this source code, or portions hereof, for any purpose, without fee, subject to the following restrictions:

1. The origin of this source code must not be misrepresented.
2. Altered versions must be plainly marked as such and must not be misrepresented as being the original source.
3. This Copyright notice may not be removed or altered from any source or altered source distribution.
4. Executables containing paintlib or parts of it must state that the software "contains paintlib code. paintlib is copyright (c) 1996-1998 Ulrich von Zadow.". This notice

must be displayed in at least one place where the copyright for the software itself is displayed. The documentation must also contain this notice.

Note that libpng, libtiff and the jpeg library have their own terms of use. You can find these in the documentation of the libraries.

resizeable lib

License

This file is part of ResizableLib

<http://sourceforge.net/projects/resizeablelib>

/Copyright (C) 2000-2004 by Paolo Messina

/http://www.geocities.com/ppescher - <mailto:ppescher@hotmail.com>

The contents of this file are subject to the Artistic License (the "License").

You may not use this file except in compliance with the License.

You may obtain a copy of the License at:

<http://www.opensource.org/licenses/artistic-license.html>

If you find this code useful, credits would be nice!

The Artistic License

Preamble

The intent of this document is to state the conditions under which a Package may be copied, such that the Copyright Holder maintains some semblance of artistic control over the development of the package, while giving the users of the package the right to use and distribute the Package in a more-or-less customary fashion, plus the right to make reasonable modifications.

Definitions:

- "Package" refers to the collection of files distributed by the Copyright Holder, and derivatives of that collection of files created through textual modification.
- "Standard Version" refers to such a Package if it has not been modified, or has been modified in accordance with the wishes of the Copyright Holder.
- "Copyright Holder" is whoever is named in the copyright or copyrights for the package.
- "You" is you, if you're thinking about copying or distributing this Package.
- "Reasonable copying fee" is whatever you can justify on the basis of media cost, duplication charges, time of people involved, and so on. (You will not be required to justify it to the Copyright Holder, but only to the computing community at large as a market that must bear the fee.)

- "Freely Available" means that no fee is charged for the item itself, though there may be fees involved in handling the item. It also means that recipients of the item may redistribute it under the same conditions they received it.
1. You may make and give away verbatim copies of the source form of the Standard Version of this Package without restriction, provided that you duplicate all of the original copyright notices and associated disclaimers.
 2. You may apply bug fixes, portability fixes and other modifications derived from the Public Domain or from the Copyright Holder. A Package modified in such a way shall still be considered the Standard Version.
 3. You may otherwise modify your copy of this Package in any way, provided that you insert a prominent notice in each changed file stating how and when you changed that file, and provided that you do at least ONE of the following:
 - a) place your modifications in the Public Domain or otherwise make them Freely Available, such as by posting said modifications to Usenet or an equivalent medium, or placing the modifications on a major archive site such as ftp.uu.net, or by allowing the Copyright Holder to include your modifications in the Standard Version of the Package.
 - b) use the modified Package only within your corporation or organization.
 - c) rename any non-standard executables so the names do not conflict with standard executables, which must also be provided, and provide a separate manual page for each non-standard executable that clearly documents how it differs from the Standard Version.
 - d) make other distribution arrangements with the Copyright Holder.
 4. You may distribute the programs of this Package in object code or executable form, provided that you do at least ONE of the following:
 - a) distribute a Standard Version of the executables and library files, together with instructions (in the manual page or equivalent) on where to get the Standard Version.
 - b) accompany the distribution with the machine-readable source of the Package with your modifications.
 - c) accompany any non-standard executables with their corresponding Standard Version executables, giving the non-standard executables non-standard names, and clearly documenting the differences in manual pages (or equivalent), together with instructions on where to get the Standard Version.
 - d) make other distribution arrangements with the Copyright Holder.
 5. You may charge a reasonable copying fee for any distribution of this Package. You may charge any fee you choose for support of this Package. You may not charge a fee for this Package itself. However, you may distribute this Package in aggregate with other (possibly commercial) programs as part of a larger (possibly commercial) software distribution provided that you do not advertise this Package as a product of your own.
 6. The scripts and library files supplied as input to or produced as output from the programs of this Package do not automatically fall under the copyright of this Package, but belong to whomever generated them, and may be sold commercially, and may be aggregated with this Package.
 7. C or perl subroutines supplied by you and linked into this Package shall not be considered part of this Package.
 8. The name of the Copyright Holder may not be used to endorse or promote products derived from this software without specific prior written permission.

9. THIS PACKAGE IS PROVIDED "AS IS" AND WITHOUT ANY EXPRESS OR IMPLIED WARRANTIES, INCLUDING, WITHOUT LIMITATION, THE IMPLIED WARRANTIES OF MERCHANTABILITY AND FITNESS FOR A PARTICULAR PURPOSE.

The End

tconvert

License

TCONVERT.H

SCA Software International S.A.

<http://www.scasoftware.com>

scaadmin@scasoftware.com

Copyright (c) 2000 SCA Software International S.A.

Date: 01.05.2000

Author: Zoran M.Todorovic

This software is provided "AS IS", without a warranty of any kind. You are free to use/modify this code but leave this header intact.

zlib

License

Zlib

zlib.h -- interface of the 'zlib' general purpose compression library version 1.2.2, October 3rd, 2004

Copyright (C) 1995-2004 Jean-loup Gailly and Mark Adler

This software is provided 'as-is', without any express or implied warranty. In no event will the authors be held liable for any damages arising from the use of this software.

Permission is granted to anyone to use this software for any purpose, including commercial applications, and to alter it and redistribute it freely, subject to the following restrictions:

1. The origin of this software must not be misrepresented; you must not claim that you wrote the original software. If you use this software in a product, an acknowledgment in the product documentation would be appreciated but is not required.
2. Altered source versions must be plainly marked as such, and must not be misrepresented as being the original software.
3. This notice may not be removed or altered from any source distribution.

Jean-loup Gailly Mark Adler

jloup@gzip.org madler@alumni.caltech.edu

The data format used by the zlib library is described by RFCs (Request for Comments) 1950 to 1952 in the files <http://www.ietf.org/rfc/rfc1950.txt> (zlib format), [rfc1951.txt](http://www.ietf.org/rfc/rfc1951.txt) (deflate format) and [rfc1952.txt](http://www.ietf.org/rfc/rfc1952.txt) (gzip format).

Glossary

ASK

The central registry for all the MediaFrame components. Other software components refer to the ASK component to establish communication and exchange commands and data as well as populate fields and lists.

Asset

See Logical Asset and Physical Asset.

Asset Details

The MediaFrame view that contains detailed information about the assets, including all the associated metadata and storyboard and video proxy information.

Asset List

The MediaFrame view that lists all the assets in a search or a folder.

Asset Navigator

The MediaFrame view that is used for searching logical assets or browsing for physical assets.

Device

In Aurora Browse, a term used to designate a component that contains physical asset. Devices have MDIs that represent the device's assets in a way that is understandable by the other components of the system. This allows the MediaFrame server to coordinate the activity of the system. Different devices perform different functions in the MediaFrame system. For example, the K2 MDI device is used for transferring assets, while the News MDI is used for Aurora Edit assets and the Flashnet (SGL) MDI is used for archiving assets.

Essence

See Physical asset.

FTP

File Transfer Protocol is a common IT protocol for the bulk movement or transfer of large volumes of data. K2 servers can handle multiple FTP transfers simultaneously at faster than real-time speeds.

HD

High Definition video.

Logical Asset

A logical asset is a combination of the MediaFrame database information, physical asset or assets on the server, and proxy assets. A logical asset has a globally unique Universal resource Name (URN) that uniquely identifies it.

Material

A high-resolution clip, upon which the low-resolution proxy is based.

MDI

Managed Device Interface.

MediaFrame

A metadata storage and asset management architecture deployed in the Aurora suite. This architecture shares media asset management (MAM) components with other applications and systems such as servers, Aurora Ingest, and Aurora Edit workstations.

MediaFrame Status

A tool in Aurora Browse that tracks the status of the various components of Aurora Browse.

Metadata

Data about data. For example, metadata can include keywords, descriptions, and other terms that you would use to search for an asset in a database. Foreign metadata is imported XML metadata that is associated with a MediaFrame logical asset.

Offline

In Aurora Browse, offline refers to an asset that has been archived. An asset can be both offline and online simultaneously.

Online

In Aurora Browse, online refers to an asset that is located on the high-resolution server. An asset can be both offline and online simultaneously.

Physical Asset

A physical asset, or essence, is the raw program material, represented by pictures, sound, text video, etc. It carries the actual message or information.

Proxy

A low-resolution clip that represents high-resolution material.

SD

Standard Definition video.

Storyboard

A series of video thumbnails used to show scene changes in an asset.

Storyboard proxy

The low-resolution video clip that provides the thumbnails for the storyboard.

Subclip

A clip created by referencing a portion of media from another clip.

Thumbnail

A frame of video used for visual identification of a clip. By default, the thumbnail is generated in the K2 server from the 16th frame of video. You can select a new thumbnail using the Storyboard.

Thumbnail view

The MediaFrame view that shows the Asset List information with thumbnails instead of strictly textual information.

Transfer Monitor

A tool in Aurora Browse that monitors asset transfers.

Up Conversion

Conversion of an SD (standard definition) video format to an HD ((high definition) video format.

Index

- .mov files
 - importing 87
- .mov format
 - converting files to 185
- A**
- adding audio narration 154
- adjusting
 - audio gain 152
 - audio levels 146
 - audio output level 150
 - cut points 129
 - read count in Story View 105
- adjusting audio 25
- Agile Timeline 112
- ANC data
 - closed captioning 96
 - preserving 96
- aspect ratio conversion
 - clips 166
 - creating a preset 168
 - manual conversion 167
- asset
 - adding general information 72
- Assignment List Manager
 - changing clip category 109
 - creating placeholders 107
 - deleting placeholders 110
 - identifying missing clips 109
 - overview 101
 - using 105
 - viewing by category 109
- audio
 - adjusting gain 152
 - adjusting levels 146
 - Audio Effects Tool 31
 - audio mixer 25
 - Audio Mixer Tool 30
 - changing levels in clip 148
 - enhanced with Fairlight and AVTransfer 163
 - enhancing using OMF files 159
 - audio (*continued*)
 - enhancing with Digidesign Pro Tools 160
 - enhancing with OMF files 159
 - enhancing with Steinberg Nuendo 161
 - EQ parameters 156
 - ganging multiple tracks 149
 - moving clips 119
 - muting track 149
 - narration 154
 - scrubbing 131
 - setting output level 150
 - soloing track 149
 - Timeline settings 151
 - viewing levels on Timeline 147
 - audio automation
 - removing 153
 - showing 153
 - using 153
 - audio crossfades
 - automatic with transitions 143
 - description 143
 - audio effects
 - about 154
 - disguising a voice 157
 - equalizing in recorded sequence 155
 - pitch adjustment 158
 - randomizer settings 158
 - using previously applied 157
 - Audio Effects Tool 31
 - audio formats
 - supported 16
 - audio mixer 25
 - Audio Mixer Tool 30
 - Aurora Edit
 - description 16
 - keyboard shortcuts 43
 - viewing monitor 24
 - window 18
 - Aurora Ingest Scheduler 180
 - Aurora Payout
 - associating placeholder 238
 - editing and 107

Aurora Playout (*continued*)

- graphics 34
- auto-mark keywords 74
- AVTransfer
 - using 163

B

- batch recording
 - about 88
 - changing row colors 90
 - creating list 89
 - loading list 91
 - rearranging list 90
 - recording to Bin 91
 - saving list 91
- Bin 19
 - changing thumbnail size 55
 - contents 21
 - creating 50
 - displaying columns 53
 - organizing 51
 - saving position 52
 - toolbar 20
 - trimming clips in 132
 - viewing in details view 53
 - viewing thumbnails 55
 - window 50
- Bin, contents toolbar 21
- Breakout Box BOB
 - viewing closed captioning 96

C

- caching proxies 81
- changing
 - master clip properties 57
 - row colors in batch capture list 90
 - thumbnail size in Bin 55
- changing audio levels in clip 148
- changing clip category in Assignment List 109
- Chyron plug-in 218
- clip
 - copy to Timeline 133
 - disguising voice 157
 - opening on Final Cut Pro 185

- clips
 - aspect ratio settings 166
 - changing audio levels 148
 - changing master properties 57
 - copy and paste 119
 - copying 57
 - copying to Timeline 119
 - creating 120
 - deleting 57
 - deleting from sequence 124
 - importing 82
 - lifting from Timeline 123
 - missing in Assignment List 109
 - moving audio 119
 - moving in Timeline 118
 - trimming 128
 - using handles 128
- clip source
 - zooming in 115
- closed captioning
 - supported and unsupported conditions 96
 - supported types 96
 - viewing on Breakout Box (BOB) 94, 96
- color
 - changing playback 244
- columns
 - displaying in Bin 53
- Commands pulldown menu 42
- Conform Manager 250
- controlling deck from Aurora Edit 114
- converting files to .mov format 185
- copy
 - clips to Timeline 119
- copy and paste
 - clips 119
- copying
 - area of sequence 120
 - clip or sequence 57
 - clip to Timeline 133
- creating
 - batch capture list 89
 - clips 120
 - Fit To Fill 169
 - new bin 50
 - new sequence 94
 - split edits 171
- creating, placeholders in Assignment List 107

- creating transitions
 - Transition Tool 30
- Cut Point Edit Tool 29, 129
 - for split edits 171
- cut points
 - adjusting 129
 - changing 129
- D**
- database
 - shared 52
- deck
 - controlling from Aurora Edit 114
- deleting
 - area from sequence 125
 - clip from sequence 124
 - clips/sequences 57
 - filters 68
 - keyword 74
 - placeholders in Assignment List 110
 - transitions 142
- details view of Bin 53
- Digidesign Pro Tools
 - using 160
- disguising a voice in a clip 157
- dissolve transitions 137
- dynamic tool window 23
- E**
- editing
 - Aurora Payout 107
 - overview 16
- editing modes 97
- editing window 21
- edit setup keyboard shortcuts 43
- EDL options for exporting 245
- EDLs
 - exporting 245
 - importing 82
- enhancing audio
 - Fairlight and AVTransfer 163
 - Steinberg Nuendo 161
- EQ
 - using previously applied effect 157
- EQ parameters
 - audio 156
- equalizing audio in recorded sequence 155
- export
 - EDL files 245
 - EDL options 245
 - files 244
 - Final Cut Pro EDL 183, 246
 - Final Cut Pro file 184
 - graphic formats 247
 - graphics files 247
 - media 248
 - media formats 248
 - media options 248
 - OMF file 159
 - removable media 249
 - video effects 201, 247
- extending edits 131
- F**
- fade control points
 - removing 148
- Fairlight
 - using 163
- files
 - exporting 244
 - exporting graphic 247
 - sorting 54
- Filter
 - creating 68
 - deleting 68
 - favorites 68
 - modifying 68
 - searching with 67
- Final Cut Pro
 - converting Aurora Edit files 185
 - exporting Aurora Edit sequence 183
 - exporting file 184
 - importing Aurora Edit sequence 184
 - opening Aurora Edit clip on 185
- Final Cut Pro EDL
 - exporting 246
- Fit To Fill 169
- foreground image
 - moving in viewer window 190

format

- exported graphic 247
- exported media 248
- graphic file 84
- media import 85

freeze frame 170

G

ganging multiple audio tracks 149

graphic

- exported formats 247
- file formats 84
- importing 83
- importing for Aurora Edit LD 83

graphics

- exporting 247

Graphics

- importing graphic files 34

Graphics tools

- Orad overview 34
- VizRT overview 34

Graphic tools

- overview 34

H

handles

- add frames to clips 128

head frame selection 55

I

import

- clips 82
- EDL files 82
- graphics 83
- media 84
- media formats 85
- MOV animation files 87
- OMF files into Aurora Edit 164
- sequence on Final Cut Pro 184
- TGA animation sequence 86
- video effects 83, 193

K

keyboard

- description 35
- keypad stickers 35

keyboard keys

- clip/track selection 37
- editing 37
- mark point 38
- other 41
- tool selection 35
- track selection 40

Keyboard keys

- deck transport 36
- transport command 36

keyboard shortcuts

- Aurora Edit 43
- edit setup 43
- MediaFrame 47
- play speed 45
- select/move 44
- tracks 45
- transports 46
- video effects 46

keyframes

- adding 74
- description 196
- inserting 197
- modifying 197
- path control 214

keyword

- add 75
- adding 74
- auto marking 74
- deleting 74
- manage 75

L

layering video effects 201

lifting clips from Timeline 123

linking to news story

- Story View functions 103

Link to Story

- overview 101

loading a batch capture list 91

loading playlist 243

local mode 52

M

- main toolbar 18
- main window in Aurora Edit 18
- mark points
 - creating 113
 - description 112
- master audio sliders 150
- master properties
 - changing 57
- Match Frame to Bin 172
- Match Frame to source 173
- media
 - exported formats 248
 - exporting 248
 - export options 248
 - importing 84
- MediaFrame
 - description 62
 - keyboard shortcuts 47
- metadata
 - printing 76
- metadata fields
 - managing 75
 - using custom 76
- missing clips
 - in Assignment List 109
- modes
 - editing 97
- MOS objects
 - in Orad graphics system 225, 226
 - in Story View 103
 - in VizRT Graphics tool 231
 - retrieving from scripts 101
 - video 180
- MOV animation file
 - import 87
- moving
 - audio clips 119
 - clips in Timeline 118
- muting
 - audio track 149

N

- narration
 - audio 154

- NCS (newsroom computer systems)
 - linking to 101
- new bin
 - creating 50

O

- offline assets
 - MediaFrame search 174
 - overview 173
 - restoring on Timeline 176
 - search results 174
 - synchronizing 176
 - unlinking restored assets 179
 - using on Timeline 175
- OMF files
 - exporting an Aurora Edit sequence 159
 - importing back into Aurora Edit 164
- OMF files to enhance audio 159
- options
 - exported media 248
 - exporting EDLs 245
- Orad graphics system
 - configuration 224
 - creating graphics 226
 - moving MOS objects onto Timeline 225
 - overview 223
 - previewing graphics 227
- organizing your Bins 51

P

- parameters
 - audio EQ 156
- path control for keyframes 214
- pitch adjustment settings 158
- placeholders
 - associating sequence with 238
 - creating in Assignment List 107
 - deleting in Assignment List 110
- playback
 - modify settings 244
 - playing all sequences in list 242
- playback colors
 - changing 244
- playback list
 - creating 241

- playback list (*continued*)
 - organizing 242
 - playing 242
- playback server
 - sending sequences 238
- playing clips
 - viewing monitor 24
- playing past out 129
- playlist
 - loading 243
 - trim sequence 243
- play speed keyboard shortcuts 45
- preserve ANC data
 - conditions 96
 - editing rules 96
- Preserve ANC Data checkbox 94
- printing metadata 76
- properties
 - changing sequence 95
- push transitions 137

R

- randomizer parameters 158
- read count
 - adjusting in Story View 105
- rearranging batch capture list 90
- recording to Bin
 - batch capture list 91
- record to tape 239
- removable media
 - exporting to 249
- removable media files 81
- removing
 - audio automation 153
 - fade control points 148
- rendering
 - transitions 141
 - video effects 200
- Restore Sequence Assets
 - button 173, 176
 - procedure 173, 176

S

- saving
 - batch capture list 91

- saving (*continued*)
 - Bin position 52
 - video effects 200
- scripts
 - linking to 101
- scrubbing audio 131
- search
 - how to organize 67
 - saving 66, 67
 - setting criteria 62
 - tips for using criteria 63
- search in Bin
 - clip 56
 - sequence 56
- select/move keyboard shortcuts 44
- selecting
 - head frame 55
- sequence
 - adding freeze frame 170
 - changing properties 95
 - copying 57
 - copying selected area 120
 - creating 94
 - deleting 57
 - deleting area 125
 - deleting clip 124
 - playing all in playback list 242
 - recording to tape 239
 - sending 238
 - storing on Aurora Edit 241
 - trim in playlist 243
 - viewing footage while playing 243
- settings
 - modify playback 244
 - Timeline audio 151
- shared mode 52
- Shared SmartBins 59
- showing audio automation 153
- Show References dialog
 - to unlink restored assets 179
- size of thumbnails in Bin 55
- slide transitions 138
- SmartBins
 - description 58
 - overview 58
 - Shared 59
 - Transfer 58

- soloing audio track 149
 - sorting media files 54
 - Source Tool 27
 - split edits 171
 - Steinberg Nuendo
 - using 161
 - storing files in Bin 19
 - Storyboard
 - displaying in Timeline 62
 - overview 24
 - Story View
 - adjusting read count 105
 - functions 103
 - Resources tab 180
 - supported media formats 16
 - Synchronize Restored Assets
 - button 173, 176
 - procedure 173
- T**
- tape
 - recording sequences to 239
 - templates for titles in Lyric plug-in 219
 - TGA animation sequence
 - import 86
 - thumbnails
 - storyboard 24
 - thumbnail view of Bin 55
 - Timeline 21
 - adding video effect 191
 - agile 112
 - audio settings 151
 - changing view manually 117
 - copy a clip to 133
 - copying clips to 119
 - lifting clips 123
 - moving clips 118
 - viewing audio levels 147
 - Timeline Tool 26
 - Timeline toolbar 21
 - Title Tool 33, 218
 - titling
 - about 218
 - Title Tool 33
 - using templates 219
 - toolbar
 - Bin 20
 - Bin contents 21
 - main in Aurora Edit 18
 - Toolbar
 - Timeline 21
 - Tools
 - Audio Effects 31
 - Audio Mixer 30
 - Cut Point Edit 29
 - dynamic tool window 23
 - Source 27
 - Timeline 26
 - Title 33
 - Transition 30
 - Trim 28
 - Video Effects 32
 - track
 - soloing audio 149
 - status of EDL sends 250
 - tracks
 - ganging audio 149
 - muting audio 149
 - tracks keyboard shortcuts 45
 - Transfer Manager
 - operation 176
 - Transfer SmartBins 58
 - transitions
 - audio crossfades 143
 - changing 139
 - creating 138
 - deleting 142
 - dissolves 137
 - pushes 137
 - rendering 141
 - slides 138
 - types 136
 - wipes 137
 - Transition Tool 30, 136
 - transports keyboard shortcuts 46
 - Transfer Manager
 - button 176
 - trim clips
 - Cut Point Edit Tool 29
 - trimming
 - clips 128
 - clips in Bin 132

trimming (*continued*)

cut points 129

trimming clips

Trim Tool 28

Trim Tool 28

U

Unlink Online Assets

button 173, 179

procedure 173

procedures 179

using

Assignment List 105

audio automation 153

V

video effects

adding keyframes 197

adding to Timeline 191

changing duration 192

choosing 194

description 189

exporting 201, 247

how work together 202

importing 83, 193

keyboard shortcuts 46

layering 201

moving foreground image 190

paths 199

rendering 200

saving 200

setting path 198

Video Effects Tool 32

Video Effects Tool 32

video formats

mixing 112

supported 16

view

Bins detail 53

Bin thumbnails 55

change Timeline manually 117

viewing by category

Assignment List 109

viewing footage of sequence 243

viewing monitor 24

VizRT graphics system

configuration 229

create graphic from within Aurora Edit 232

editing in Aurora Edit and Edit LD 234

moving MOS objects onto Timeline 231

NLE Configuration Tool 230

overview 228

preview on Timeline 234

voice disguise 157

W

window

Bin 50

wipe transitions 137

working modes

local 52

shared 52

X

XDCAM formats

notes about 81

Z

zoom controls

clip source 115

tips 116