



grass valley

A **BELDEN** BRAND

**ITX**

INTEGRATED PLAYOUT

## **System Administrator Guide**

iTX v2.7

Issue 1.2 (2016-01-12)

[www.grassvalley.com](http://www.grassvalley.com)

## Copyright & Trademark Notice

Copyright © 2016 Grass Valley USA, LLC. All rights reserved.

Belden, Belden Sending All The Right Signals, and the Belden logo are trademarks or registered trademarks of Belden Inc. or its affiliated companies in the United States and other jurisdictions. Grass Valley and iTX are trademarks or registered trademarks of Grass Valley, a Belden Brand. Belden Inc., Grass Valley and other parties may also have trademark rights in other terms used herein.

## Terms and Conditions

Please read the following terms and conditions carefully. By using iTX v2.x documentation, you agree to the following terms and conditions.

Grass Valley, a Belden Brand (“Grass Valley”) hereby grants permission and license to owners of iTX to use their product manuals for their own internal business use. Manuals for Grass Valley products may not be reproduced or transmitted in any form or by any means, electronic or mechanical, including photocopying and recording, for any purpose unless specifically authorized in writing by Grass Valley.

A Grass Valley manual may have been revised to reflect changes made to the product during its manufacturing life. Thus, different versions of a manual may exist for any given product. Care should be taken to ensure that one obtains the proper manual version for a specific product serial number.

Information in this document is subject to change without notice and does not represent a commitment on the part of Grass Valley.

Warranty information is available in the Support section of the Grass Valley Web site ([www.grassvalley.com](http://www.grassvalley.com)).

Title	System Administrator Guide for iTX 2.7 (Issue 1.2)
First Issued	3 July 2015
Revision	12 January 2016

## Contents

About this manual .....	8
Software versions.....	8
Assumptions.....	8
About the iTX system.....	9
System architecture .....	9
iTX software modules.....	10
iTX machines, their operating systems and other required software .....	11
iTX system design.....	15
System time source.....	15
Back-up protection.....	15
System options.....	15
Preparing a system for iTX software .....	17
Network connection.....	17
Using a DHCP server to allocate an IP address for a Locator Service machine.....	17
Locator Service – name resolution.....	17
General machine requirements .....	18
Preparing the Database Server machine .....	21
Preparing the Media Store.....	22
Preparing Output Server machines.....	23
Preparing Encode Server machines .....	23
Installing Drivers for SDI video cards .....	24
Installing iTX software modules .....	27
Installation notes.....	27
Pre-installation check list .....	27
Running the iTX installer .....	28
Install the Database Server module.....	34
Installing the iTX Database on a Remote Server.....	35
Install the Media Watcher on a stand-alone Media Store, or other machine.....	39
Install an Output Server module.....	41
Install a Desktop Client module .....	45
Install the Software Distributor module on a stand-alone machine .....	46
Install the Encode Server module .....	47
Re-configuring a service after installation .....	48
Creating a Locator domain configuration file .....	49
Setting up services to start automatically on machine start-up.....	51
Rolling back iTX modules.....	52
Starting the iTX system services .....	55
Checking the Server Controllers.....	56

Checking the iTX system services.....	58
Adding users to the security system .....	58
Security in an iTX system .....	60
The security system of the iTX System Service .....	60
About the Security Tool .....	64
Using the Security Tool .....	68
Configuring a Media Watcher .....	73
The Setup tab .....	74
Inbox settings .....	75
Adding a file store of the store type to the File Stores list .....	78
Adding a file store of the search type to the File Stores list .....	80
Adding file stores of the Mirror type to the File Stores list .....	87
Modifying the File Stores list.....	88
Managing file stores.....	88
File-copying speed.....	90
Selecting default clip templates for media files imported through the Inbox.....	90
Searching for files requested by a Media Cache Service .....	91
Setting up search domains under the Domains tab.....	91
Configuring a Media Watcher to copy media files to an independent back-up system.....	92
Configuring the Time Service.....	93
Starting iTX Desktops.....	95
About the iTX Desktop .....	95
Checking the connection of iTX Desktops to the system services .....	97
About service status indicators.....	98
Setting up views for workstations and operators .....	100
Layout views.....	100
Registering of workstations and operators before the assigning of layout views.....	101
Layouts available for layout views .....	101
Standard layouts .....	102
Using cloned layouts .....	105
Creating a system-administrator layout view.....	105
Assigning layout views from your system-administrator view .....	107
About channel views.....	110
Setting up a channel view .....	112
Assigning a channel view .....	114
Modifying layouts .....	116
About the layout-editing mode.....	117
Configuring service-monitoring components .....	118
Attaching an audio file to an Alert button .....	119
Adding an Auto Failover Control to a layout.....	120
Configuring component groups .....	121



Configuring the PinPoint panel on the Asset layout .....	122
Configuring search buttons on the Asset layout.....	123
Configuring Encoder Settings buttons .....	123
Configuring router components.....	124
Configuring the hold time for the previewing of events.....	127
Configuring Re-cue control .....	128
Making a layout global .....	128
Saving a layout .....	129
Exiting the layout-editing mode.....	129
Cancelling unsaved changes to a layout .....	129
Configuring channels .....	130
System Wide Configuration .....	131
Restricting Asset Search by Channel .....	135
Modifying the properties of channels.....	135
Using the Channel tab.....	136
Channel Config 1 – for all channel types.....	137
Channel Config 2 – for playout, edit and scheduled-ingest channels.....	138
Channel Config 3 – for playout channels .....	141
Channel Config 4 – for playout channels .....	149
Using the Configure Output Server dialog (Output Server 1 only) .....	155
Using the Configure Alerts dialog .....	162
Using the Advanced Aspect Ratio Control – Mapping Configuration dialog .....	163
Media Keep List – for playout channels .....	165
The Cache Settings tab – cache channels .....	168
The Scheduled Booking Config tab – scheduled-ingest channel .....	169
The Ingest Config tab – scheduled-ingest channel .....	169
Using a spreadsheet to set properties for a group of playout channels.....	170
Configuring channel plug-ins .....	172
Modifying the properties of channel plug-ins.....	173
Configuring the audio output for a playout channel.....	195
About audio channels and tracks (and streams).....	195
Encoded-data formats for playout.....	196
Configuring the audio output of an Output Server.....	196
Using the Audio Mapping panel.....	206
Upgrading a system that is configured for clip mapping .....	209
Output Server settings for Dolby Digital and Dolby E audio .....	209
Running iTX services .....	210
Common user-interface tabs .....	210
Using the Server Controller Configuration tool .....	215
Working with the services on the Database Server machine .....	218
Service-window features of iTX services on the Database Server machine .....	218

- Working with the Media Watcher ..... 226
  - Extra service-window features for the Media Watcher.....234
- Alternative Workflow-driven media imports ..... 237
- Media Import Configuration Tool..... 238
  - Installation .....238
  - Usage.....239
- Working with iTX services on an Output Server machine ..... 241
  - Extra service-window features for services on the Output Server machine .....241
  - The iTX Player window .....249
- The Media Cache Service..... 250
  - Caching in a single domain.....250
  - Skipping of missing media files .....252
  - Interruption to caching .....252
  - Cache management .....252
  - Caching in a multi-domain system .....253
  - Caching for a sub-channel.....253
  - Search order of domains in multi-domain caching.....253
  - Setting up a system for multi-domain caching .....254
  - Media Cache Service window .....254
  - Cache channel in a Schedule Grid .....256
- Working with iTX services on an Encode Server machine..... 258
  - Extra service-window features for the services on an Encode Server machine .....259
- Using iTX Desktop layouts for system administration..... 263
  - The Engineering layout .....263
  - The Logging pop-up layout.....268
  - The OPUS Administration pop-up layout.....270
  - The Naming Rule Configuration pop-up layout .....272
  - The Colour Configuration pop-up layout .....275
  - The Colour Selector.....277
  - The Server Manager layout.....278
- Upgrading or uninstalling iTX software modules on single machines ..... 281
  - Upgrading an iTX software module .....281
  - Uninstalling an iTX software module .....283
  - Installing a different type of iTX software module on a machine.....284
  - Migrating between Output Server 1 and Output Server 2 .....285
- Upgrading a batch of iTX server machines ..... 286
  - The Software Distributor.....286
  - The iTX Software Updater .....287
  - Setting up and running an automatic batch upgrade .....287
- Closing down your iTX system ..... 290
  - Closing down an iTX Desktop .....290

Closing down a server machine .....	290
System resilience .....	291
Service resilience modes.....	291
Redundancy options .....	292
Running a back-up Database Server .....	295
Running a back-up Output Server.....	296
Running a standby Output Server.....	298
Running a back-up Encode Server.....	300
Add a Output Server 2 simulcast channel to an iTX system .....	300
Duplicating a live source .....	301
Using iTX with a matrix router.....	304
Setting up an iTX system for routing.....	304
Installing a Router Bridge.....	305
Configuring an iTX system after the installation of a Router Bridge.....	306
Updating information from the Router Bridge .....	308
Installing a GVG Acappella Router Server .....	310
Configuring an iTX system after the installation of a GVG Acappella Router Server.....	310
Installing an NVision NV9000 Router Control System Service.....	312
Configuring an iTX system after the installation of an NVision NV9000 Router Control System Service .....	312
Installing the Evertz 7700 Router Server .....	314
Configuring an iTX system after the installation of an Evertz 7700 Router Server.....	315
Installing the Quartz Router Service .....	316
Configuring an iTX system after the installation of a Quartz Router Service.....	317
Installing the Hardwired Router (for a dummy router) .....	318
Configuring an iTX system after the installation of a Hardwired Router.....	319
The Routing Configuration pop-up layout .....	321
Filtering by groups in routing configuration .....	323
Setting up router control on the Router Control layout.....	324
Using the features on the Router Control layout .....	325
Using iTX with a GPI device .....	327
The GPI Service.....	327
Installing the GPI Devices module.....	327
Configuring the GPI Service.....	328
Assigning GPI inputs to playout actions.....	332
Setting up a Videoframe VNode .....	332
Using Missing Materials Manager .....	334
About Missing Materials Manager.....	334
Installing the Missing Material Service module .....	335
Configuring Missing Materials Manager .....	336
Configuring an iTX Desktop to accept commands from a keyboard or hard panel .....	344
Component-input mapping.....	344

Macro mapping.....	351
Using iTX with the XML Adaptor.....	354
About the XML Adaptor .....	354
Installing the iTX XML Adaptor module .....	354
Setting up multiple service instances.....	354
Configuring the XML Adaptor .....	355
Using iTX with the Alerts Forwarding Service .....	358
About the Alerts Forwarding Service .....	358
Installing the Alerts Forwarding Service module .....	358
Configuring the Alerts Forwarding Service .....	358
Testing the Alerts Forwarding Service .....	360
iTX Emergency Alerts Service.....	360
Using iTX with the RSS Streamer .....	361
Installing the RSS Streamer module.....	361
Starting the RSS Streamer.....	361
Configuring the RSS Streamer .....	362
Using iTX Workflow .....	365
About the Workflow Service and job services .....	365
Media Rules and MediaFlow Processes.....	367
Installing iTX Workflow components.....	367
Configuring workflow definitions in the Workflow Service .....	370
Configuring the File Copy Service.....	373
Configuring the Proxy Generation Service.....	374
Running the iTX Workflow services .....	374
Enabling iTX v2 to use the assets in an iTX v1 system.....	375
Identifying the iTX v1 domain .....	375
Installing the iTX software module .....	376
Configuring other services .....	377
Running the new services .....	378
Checking the interaction of the two systems .....	378
BXF Schedule Importing .....	379
Installing the Workflow Application Service .....	379
Configuring the Workflow Application Service .....	379
Importing of Harris ADC100 schedules .....	385
Setting up the Workflow Application Service for importing Harris ADC100 schedules.....	385
BXF As Run Support .....	386
HDSDI/SDI Preview from an iTX Desktop .....	387
Video playout .....	387
Audio playout.....	387
Installing the feature.....	388
Media Viewer options.....	389

Licensing.....	390
Not supported.....	390
Comparison of functionality.....	390
Supporting Tools.....	392
OPUS Metadata import tool for Core Systems .....	392
Updating Aspect Ratio information database location.....	393
About the TeleStream Vantage Job Service.....	394
About Interra Baton QC Job Service.....	399

## About this manual

In this manual, we describe the steps you should follow to install and configure the software modules that provide the functionality in an iTX system.

We tell you how to start the system services, which are used by operators at iTX Desktop Client workstations, and how to monitor these services to ensure the iTX system continues to run effectively.

## Software versions

The manual covers various releases of iTX version 2 (identified by version numbers v2.1, v2.2, etc.). Some of the features described in the manual may not be available in your version of software. For more information, contact iTX Support.

This manual covers generic installation and configuration for both Output Server 1 and Output Server 2-based iTX systems. However, the installation of Output Server 2 and the configuration of Output Server 2 channels is covered in the *iTX Output Server 2 Channel Configuration Guide*.

## Assumptions

To successfully install and set up an iTX system, you need to have a certain level of IT knowledge and experience. We make these assumptions:

- You have system-administrator privileges for the network.
- You have experience of installing and configuring client-server software on a TCP/IP network.
- You are capable of installing and setting up an SQL database.
- You will install the software on machines that have been connected to a LAN or WAN by a competent network engineer.
- You are familiar with the arrangement of the machines in the iTX system and know which machine is to be used for which purpose. We describe the different types of machines in "About the iTX system" (see page 9) in this manual.
- You understand generally the main broadcasting concepts of the iTX system; e.g. the function of the VITC time feed, and the method used for broadcasting the output of the iTX system.

# About the iTX system

## System architecture

For those who are familiar with previous versions of iTX, we summarise below the main differences between the system architectures of iTX v1 and iTX v2.

Whereas iTX v1 operates within our previous (G<sup>3</sup>) Framework, iTX v2 is designed to operate on our latest iTX platform. There are two significant differences between the two system architectures:

- The ability in iTX v2 to use Microsoft Windows Discovery Service for service and client connections. This makes it possible for iTX v2 to work using either of two service-connection models: Locator-based or Discovery-based.
- The merging of functionality into fewer services in iTX v2.

We explain the differences in more detail below.

### Service-connection model and system domains in iTX v1

iTX v1 uses the Locator model for the connecting of services and clients. In this model, the Locator Service gives services and clients the connection details they need to interact with each other; it also manages failover to back-up services. The Locator Service defines the iTX domain in which the various system components (services and iTX Desktops) operate.

### Service-connection models and system domains in iTX v2

iTX v2 can use either the Locator model or the Discovery model for service and client connections. Failover of services is generally managed by the services themselves. An iTX domain is formed by services and clients that have a common domain name – this is set for the machines on which they run.

In the Locator model, the iTX Locator Service provides the service connection details.

In the Discovery model, an alternative method for connecting services and clients is available through the Microsoft Windows Discovery Service. Each service and client broadcasts its presence to all other services and clients in its domain; it keeps its own list of domain members and the connection details it needs to be able to interact with them.

The Discovery model requires special configuration of the IT network and is best suited to single-domain systems.

For multi-domain systems, especially those spread over a large network, we recommend you use a Locator Service in each domain to share service-connection information with each other. In such a system, there is less network traffic between domains than there is in a system that uses the Discovery model. Such a set-up is necessary if any of the domains is an iTX v1 domain, since iTX v1 does not support the Discovery model.

## Merged services and new services

Some individual Framework Services that iTX v1 uses have been combined into a single Framework Service for iTX v2: the iTX System Service replaces the Object Data Service, Security Service and Alerts Service.

Similarly, the two services for media-asset management are merged: the OPUS 2 service replaces the Media Search Service and the Media Data Service. The OPUS 2 Service also includes two services, the Keyframe Service and the Text Indexer Service, that were not in iTX v1.

The iTX Logging Service replaces the previous Logging Service.

The iTX As Run Service replaces the Schedule Data Service.

All iTX v2 services run under the control of the iTX Server Controller.

## iTX software modules

The iTX system software is organised in a number of software modules and supplied in a folder called iTX Suite (followed by the software-version number):

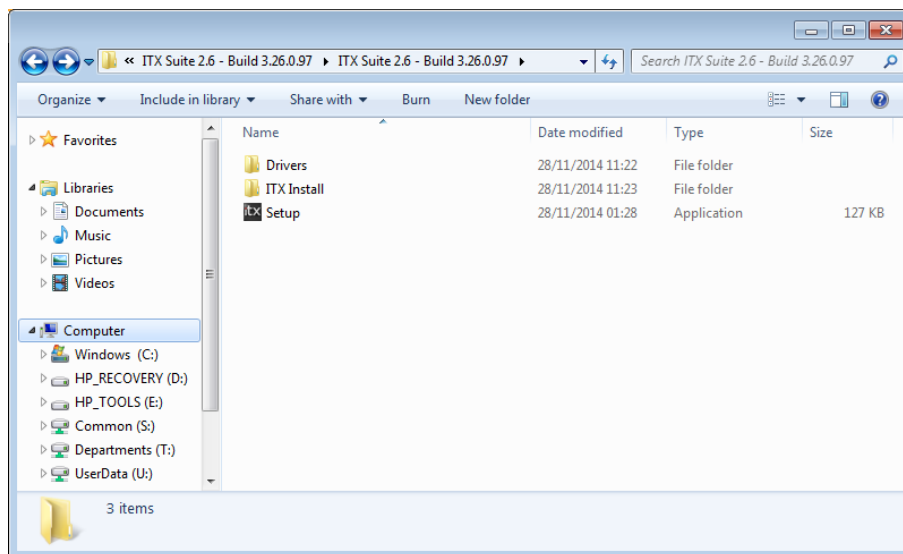

The folder includes an automatic installer, called **Setup**. By running the installer, you can install standard iTX v2 software modules and some custom ones.

For a basic playout system with the manual ingest of media, you usually install these modules:

- Database Server
- Output Server
- Desktop Client
- Media Watcher
- Encode Server
- Software Distributor



## Drivers for SDI video cards

The installation folder includes a subfolder, called Drivers. This folder contains the required device drivers for the SDI video cards that iTX can use. If any machine in your iTX system does not have the correct driver for the version of Output Server you are using, you need to install one from this folder. [More details](#), page 24.

## Processing of multi-channel audio

iTX includes an option to use Dolby\* technology to decode and encode Dolby Digital and Dolby E audio content. For these options, separate iTX Licenses are required.

\*Dolby is a registered trademark of Dolby Laboratories.

# iTX machines, their operating systems and other required software

For a basic iTX system, with playout and recording facilities, you need the machines we describe here. Complex iTX systems may require additional, or more powerful, machines.

## Database Server – one per system

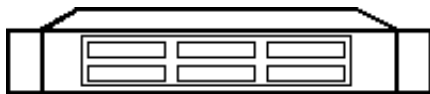

Required operating system:	Microsoft Windows Server 2008, Standard 64-bit Edition R2 with Service Pack 1.
Required other software:	A Microsoft SQL database server: SQL Server 2008 Standard Edition.
iTX software module:	Database Server.  Optional: Media Watcher (with iTX Desktop layouts).

The Database Server module includes the iTX System Database and the system services.

In small systems, the Database Server machine may also act as a Media Store. It then requires the Media Watcher to run on it. The iTX Desktop layouts are installed with the Media Watcher, which registers them for use in your iTX system. [More details](#), page 12.

If you are using iTX with any of the following system options, you may install the required software modules on the Database Server machine:

- A matrix router.
- A GPI device.
- The Missing Materials Manager.
- The XML Adaptor.

## Media Store – one or more per system

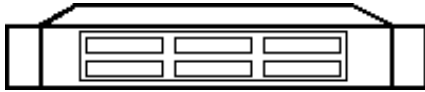

Required operating system:	For a standalone Media Store: Any version of Microsoft Windows that gives a specified number of users' simultaneous access to the Media Store contents.
iTX software module:	Media Watcher (with iTX Desktop layouts).

The Media Store holds the media files that are to be available for use in playout schedules. It may be a standalone machine, or it may be part of the Database Server machine. There may be more than one Media Store in an iTX system.

The Media Watcher runs on the Media Store (provided the Media Store allows this). Where there are multiple Media Stores, it runs on the main one.

If the Media Store does not allow iTX software to run on it, the Media Watcher should run on the Database Server machine instead. Since this requires the use of network (UNC) paths in file transfers, the processing of files in the Inbox takes slightly longer than when the Media Watcher runs on the Media Store.

There must be at least one Media Watcher in an iTX system, to monitor the Inbox on the Media Store. There may be other Media Watchers in a system, doing the same jobs for different Media Stores as well as managing the copying of media files that are needed for playout to the Output Server caches.

iTX Desktop layouts are installed with the Media Watcher, which registers them for use in your iTX system.

## Output Server – one per playout channel (SD or HD)



Required operating system:	Microsoft Windows Server 2008, Standard 64-bit Edition R2 with Service Pack 1.
iTX software module:	Output Server or Output Server HD.  Optional: Media Watcher.

The Output Server machine is the iTX playout engine for a single channel.

For a system that requires a channel to play out content to several regions simultaneously, you can include up to 8 additional regional channels per main playout channel. Each regional channel requires an additional Output Server.

## License dongle

The Output Server machine must have a hardware License key, or "dongle", inserted in one of its USB slots. This authenticates the iTX software and allows you to use the software once the License is registered in the iTX system.

The License allows specific iTX plug-ins to run. The plug-ins provide the features on components that the scheduling services, TXPlay and TXEdit, use to process media files of different types. You may start with a basic iTX system that has reduced functionality, and later increase the functionality by adding License files to activate more plug-ins; you do not need to change the dongle.

New License files can be registered with the system in two ways. They can either be copied into any Media Watcher's Inbox, where they will be processed by the Media Watcher itself and the iTX database will be updated with details of the new functionality.

Or you can import them via the System Service, which is usually running on a framework server:

1. Locate the System Service and click on the **Licensing** tab.
2. Select the sub tab labelled **License Details**.
3. Click the **Import License** button.
4. Browse to the directory where you have downloaded your License files to.
5. Select the License file and click **OK**.

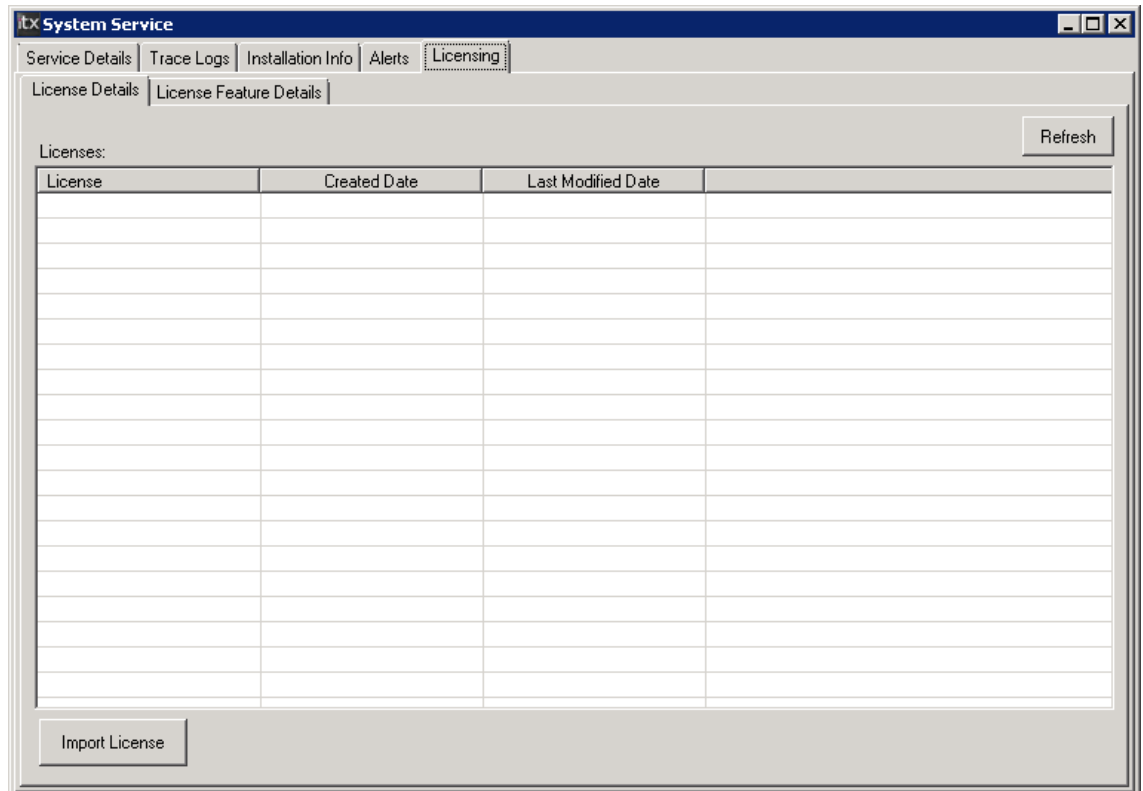

**NOTE:**

- You will need to restart the services running on the machine you have updated the License for in order for it to expose the new features.

**Desktop Client workstation – one per operating position.**

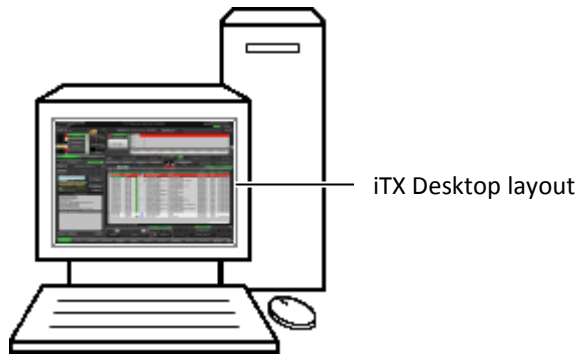

Required operating system:	Microsoft Windows XP Professional with Service Pack 2 or Microsoft Windows 7.
iTX software module:	Desktop Client.  Optional (on a system-administrator workstation): Software Distributor.

The Desktop Client module consists of the iTX Desktop (a user interface for systems based on iTX technology), a set of iTX Desktop layouts, and the controls that feature on the layouts. Together these form the iTX Desktop, through which an operator interacts with the iTX system in building and controlling playout schedules and in recording and managing media for use in schedules.

There is only one version of the iTX Desktop, but it can run in administrator mode or operator mode; this depends on the security attributes of the user who starts it.

**Encode Server – number dependent on the required capacity for simultaneous recordings**



Required operating system:	Microsoft Windows Server 2008, Standard 64-bit Edition R2 with Service Pack 1.
iTX software module:	Encode Server.

The Encode Server module provides a recording channel under the control of the Encode Server. This operates an encoder to record a digital video signal, which the machine receives through a serial (SDI) connection. The source of the video signal may be a videotape, video server or live feed. The encoder converts the video into a file, in a selected storage format, and places this in the Media Store.

The Encode Server machine must have a video capture card, capable of handling the incoming video.

### License dongle

The Encode Server machine must have a hardware License key, or "dongle", inserted in one of its USB slots. This authenticates the iTX software and allows you to use the software once the License is registered in the iTX system.

**Note:** If there is no requirement to record media, the iTX system does not have to include an Encode Server machine.

## iTX system design

iTX systems can vary greatly in the number of Output Servers, Desktop Clients, Media Stores and Encode Servers they contain. But, in general, every basic system is a variation of one of two models. In one model, the main Media Store is a standalone device; in the other, the Media Store is part of the Database Server machine.

## System time source

The Time Service keeps time in an iTX system and distributes it to parts of the system that require it; for instance, TXPlay, the playout service on the Output Server.

The time the service delivers is in the international time standard known as UTC (Universal Time, Co-ordinated). To be able to supply the correct time, the Time Service needs to receive an accurate time reference signal. It may get this from one of three sources:

- A VITC input card connected to a VITC generator.
- The PC clock on the Database Server machine.
- An external NTP (Network Time Protocol) server.

If the reference signal is interrupted, the Time Service continues to keep time using an internal system process, until the reference signal is restored.

The Time Service runs on a separate machine, the Time Server, in a system that uses a VITC generator to provide a time reference signal. In a system with no VITC generator, it runs on the Database Server machine.

## Back-up protection

You can apply various levels of back-up protection to an iTX system. [More details](#), page 291.

## System options

The iTX system software has modules for a variety of system options. These include:

- Media acquisition features that enable iTX to access media content on Front Porch Digital DIVArchives, Suitcase TV archives, Omneon Spectrum video servers and FTP servers.
- Regional channels that can play out their own media content (such as commercial breaks) across multiple regions. You can include up to 8 regional channels per playout channel. Each regional channel in an iTX system requires an additional Output Server.
- Control of a Screen Polistream subtitling system that iTX delivers its output signal to.
- Control of an external Grass Valley logo inserter that iTX delivers its output signal to.
- Control of an external character generator that iTX delivers its output signal to. Supported devices include the Pixel Power Clarity and the VizRT character generator.
- The control of GPI devices, matrix routers and hard panels.
- The management of missing media content.
- The generation of keyframes and low-resolution browse copies for video clips.

# Preparing a system for iTX software

Before you install the iTX software modules on their machines, you should ensure the system meets the requirements that we outline in this section.

## Network connection

The machines that are to receive the iTX software modules should be connected to a TCP/IP network – LAN or WAN – in an arrangement with these characteristics:

- The network and the machines can handle data rates of at least 1000 Mbps.
- All machines are in the same network domain or workgroup.
- None of the machines is connected to the internet.

Ensure all intended users have network user accounts.

## Using a DHCP server to allocate an IP address for a Locator Service machine

The iTX system services, which provide the operating platform for iTX, include an optional service called the Locator Service. Many iTX systems use this service, even single-domain systems that use the Discovery model for finding services. Sometimes a system has multiple Locator Services, for load balancing or multi-domain connections.

Any machine on which a Locator Service runs must have a static IP address. If the iTX network uses a DHCP server to allocate IP addresses, this server should be set up to provide a static address for each Locator Service machine.

## Locator Service – name resolution

All other system services contact the Locator Service by using its host name, "omn-locator". iTX translates this host name into an IP address in one of two ways: either by using a WINS or DNS server, if there is one in the system; or by referring to a local-machine Hosts file.

**Important:** If you are installing iTX in a system that uses a WINS or DNS server to resolve host names, you must enter the Locator Service details in the server *before* starting to install the iTX software.

To enable iTX to get IP addresses from a Hosts file instead of a DNS server, you enter the IP address of the Locator Service during the software-installation process. For more information about Hosts files, see the Help information for a particular machine operating system (e.g. Windows XP).

## General machine requirements

### Hard-disk size

We recommend you install the iTX software modules onto machine C-drives.

For the Database Server, the capacity of the C-drive (or alternative hard-disk partition) should be at least 20 GB; for other iTX machines, at least 10 GB.

For an Output Server, ensure the Cache partition is separate to the machine C-drive.

For an Encode Server, ensure the media storage partition is separate to the machine C-drive if you are going to encode media to the local drive.

### Date and time properties

Set the time zone on all machines to GMT. Ensure daylight saving time is not enabled and the correct date and time are set.

### Automatic logon

To allow a machine in the iTX system to restart more quickly, you set the machine for automatic logon.

For more information about setting a machine for automatic logon, see the Help information for the machine operating system.

### Windows error reporting

Certain conditions may cause an iTX system service to stop. If this happens, iTX keeps running by restarting the service automatically.

The error reporting feature of the Windows operating system can interfere with the automatic restarting. Ensure error reporting is disabled for all machines that run system services (Database Server, Media Store, Output Servers, and Encode Servers). You set the option under the Advanced tab of the System Properties control panel.

### Windows updates and security

Some common security features may prevent iTX working properly and should not be used:

- On all machines, switch off automatic software updates.

Apply all Windows software updates and services packs before you install the iTX software modules.

If you run anti-virus software on the iTX machines, you should configure it so that it does not scan any folders containing media files.



## Windows Indexing

Windows Indexing and the Indexing Service can adversely affect system performance. You should disable these on all machines in the iTX system.

Display the Properties dialog for the hard-disk partition onto which you are going to install any iTX software module.

Under the General tab, clear the check box for **Allow Indexing Service to index this disk for fast file searching**:

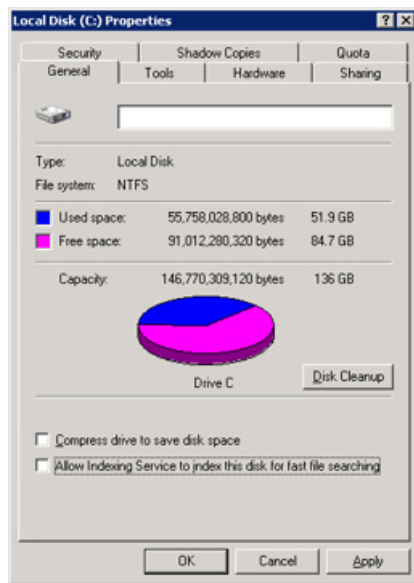

From the Windows Start menu, select **Run** and enter "services.msc" to display the Services window in the Microsoft Management Console. Stop the Indexing Service and set its Startup type to "Disabled".

## Shutdown Event Tracker

If the Windows operating system on a machine stops, you need to restart the machine. A feature of the operating system – the Shutdown Event Tracker – can reduce the speed of the machine restarting. To prevent it doing so, you should disable the feature on all iTX servers.

From the Windows Start menu, select **Run** and enter "gpedit.msc" to display the Group Policy window in the Microsoft Management Console.

Under Computer Configuration in the console tree, open the Administrative Templates folder and then the System folder to display the contents of the System administrative template.

Open the Display Shutdown Event Tracker Properties dialog. Under the Setting tab, select **Disabled**:

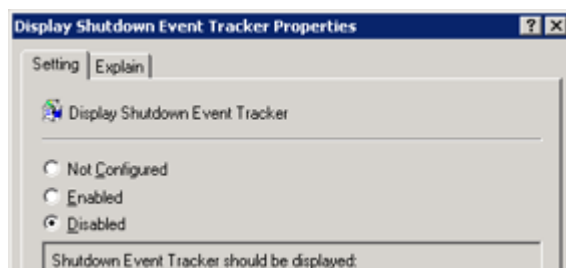

## Response to Windows system failure

You should configure the Windows system on each machine to provide information about the cause of any Windows system failures. You do this in the Startup and Recovery dialog, which you display by selecting it under the Advanced tab of the System Properties control panel.

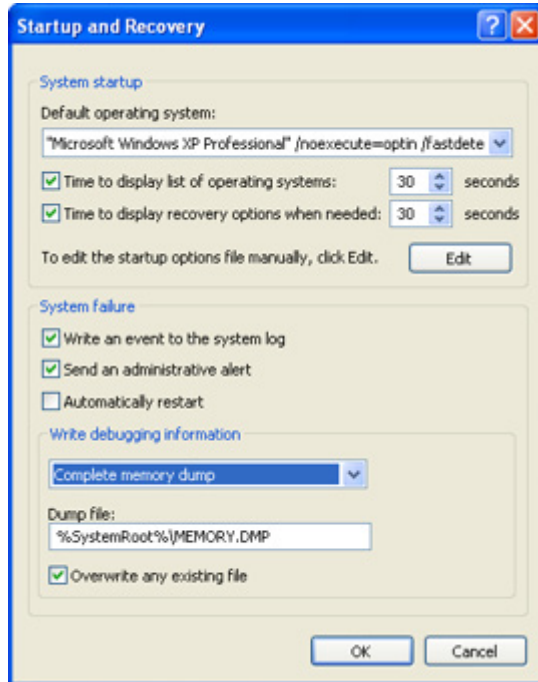

In the System failure section:

- Select the Write an event to the system log check box.
- Clear the Automatically restart check box.

In the Write debugging information section:

- Select Complete memory dump.

## Windows event logs

To ensure the Windows operating system on all machines in the iTX system is working properly, the event logs should be checked and cleared.

From the Administrative Tools control panel, display the Event Viewer in the Microsoft Management Console. In the list of event types, check and clear the event logs for the Application, Security and System events.

## Network adapters – binding order

In an iTX system with multiple network connections, the order that Windows network services access the network connections may prevent iTX from working properly. If the order is incorrect, the iTX services may not be able to interact.

On each server machine, ensure the Local Area Connection for the iTX network is first (highest) in the Connections list. You can view this list in the Network Connections Advanced Settings dialog:

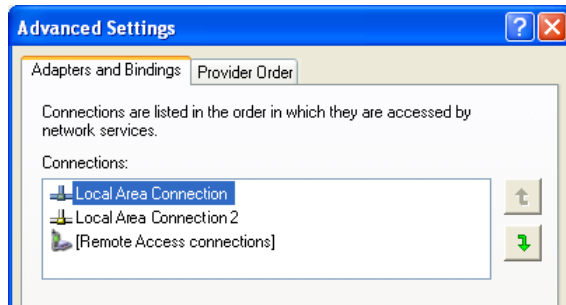

To display the dialog, open the Network Connections folder from the Windows Start menu; select **Advanced Settings** from the Advanced menu.

### Display and power-saving properties

- Switch off screen savers.
- Switch off power-saving options for monitors and hard disks.

## Preparing the Database Server machine

Before you install any iTX software module on the Database Server machine, you need to install Microsoft SQL Server 2008; we recommend you install the Standard Edition.

### Microsoft SQL Server log-in password

In a standard system, iTX communicates with Microsoft SQL Server through the trusted connection of your system-administrator Windows user account. So, simply starting the Database Server machine by entering your system-administrator username and password enables iTX to connect to SQL Server.

In SQL Server, an alternative user account may be created with the required access rights and a log-in password specified (this is a separate password to the one you use for your system-administrator user account).

When you install the Database Server module, you need to select the method of access to the SQL Server. You may select the trusted connection; or you may select the alternative user account. If you select the second option, you must enter the correct log-in password; failing to do so prevents the iTX installer installing the iTX software module.

### Install Microsoft SQL Server 2008

1. Disable the firewall on the Database Server machine, or open the ports that are required for the remote access of SQL Server.
2. Follow the Microsoft installation instructions to install SQL Server 2008. In general, accept the default settings. For the particular settings listed below, select the options as described.
  - On the Feature Selection page, select: **Database Engine Services; Management Tools - Basic**. For a mirrored system, select: **Management Tools - Complete**.
  - On the Instance Configuration page, select: **Default instance**.

- On the Server Configuration page, under the Service Accounts tab, select: **Use the same account for all SQL Server services.**
- On the Server Configuration page, under the Collation tab, ensure the default setting in the Database Engine box indicates case-insensitivity (CI); e.g. **Latin1\_General\_CI.**
- On the Database Engine Configuration page, under the Account Provisioning tab, select **Mixed Mode** authentication, and enter the iTX password; select the Windows user account as a SQL Server administrator.

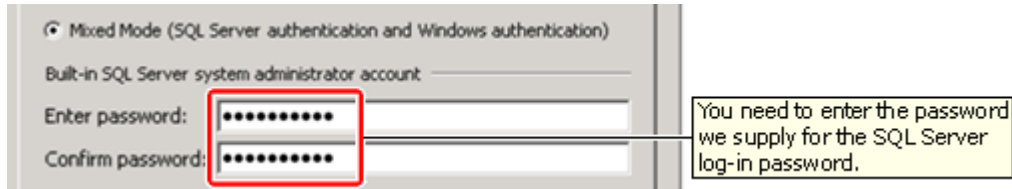

- On the Error and Usage Reporting page, ensure the options for error and usage reporting are not selected.
3. On finishing the installation, restart the machine to start SQL Server.
  4. Install the latest SQL Server service pack and Microsoft Windows updates. Restart the machine.

## Configure SQL Server

1. In the SQL Server Configuration Manager, under SQL Server Network Configuration, select **Protocols for MSSQLSERVER**; ensure the TCP/IP protocol is enabled.

## Preparing the Media Store

iTX requires two shared folders to be on the Media Store, on the same drive:

- One called **Inbox**. This is to be monitored by the Media Watcher, which registers media that enters the Inbox, so that iTX can use it. The folder name must begin with a capital letter.
- One called **Media**. This is to hold the media files after the Media Watcher registers them. The folder name must begin with a capital letter.

You should create these folders before installing the iTX software module for the Media Watcher.

This illustration shows a folder structure with the shared folders:

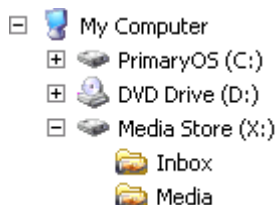

If a system contains more than one Media Store, you should create these folders on the main Media Store.

## Preparing Output Server machines

On each Output Server machine, create a volume (disk partition) called **Cache** to act as a local cache for schedule items that are due to play out.

In the Cache volume, create a folder also called **Cache**. The folder name must begin with a capital letter.

This illustration shows a folder structure for this arrangement:

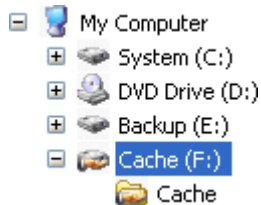

### Driver for SDI video card

Ensure the correct device driver for the SDI video card in the machine is installed.

Note:

- Output Server 1 and Output Server 2 require different versions of the AJA video card drivers, both of which are provided with the iTX iTX Suite. This includes device drivers for supported Xena SDI-video cards. More details, page 24.

### License dongle

On each Output Server machine, insert the supplied License dongle in a USB port.

### Windows sound scheme

A Microsoft Windows sound scheme, which you use to assign sounds to system events, can disrupt the playout of audio from an Output Server machine. Ensure all sound schemes are disabled on Output Server machines; alternatively, disable the Audio Service.

### Smooth edges of screen fonts

CG files usually include text. To ensure the text displays properly, select the "Standard" method to smooth the edges of screen fonts on Output Server machines.

## Preparing Encode Server machines

An Encode Server machine has similar requirements to an Output Server machine. For each Encode Server machine:

- Ensure the correct device driver for the SDI-video card in the machine is installed.
- Insert the supplied License dongle in a USB port.

## Windows sound scheme

A Microsoft Windows sound scheme, which you use to assign sounds to system events, can disrupt the recording of audio on an Encode Server machine. Ensure all sound schemes are disabled on Encode Server machines; alternatively, disable the Audio Service.

## Direct connection to a VTR

If you want the Encode Server to be able to control a VTR (videotape machine), connect a breakout cable with a Sony 9-pin connector between the Encode Server machine and the VTR. This functionality requires a suitable SDI-video card to be installed in the Encode Server machine. More details are in the iTX Hardware Specification, which you can download from the Club iTX website.

# Installing Drivers for SDI video cards

## AJA video card driver version

Output Server 1 requires AJA video card driver version v7.4.0.49 and Output Server 2 requires AJA video card driver version 12.1.0.107. Both versions of the drivers are included in the iTX Suite, within the Drivers folder.

You can verify the version of the currently installed drivers by accessing the AJA Corvid SDI I/O Properties or AJA Kona 3G SDI I/O Properties window from Device Manager.

### Note:

- Do not use drivers that are supplied with the card or have been downloaded from the AJA website. The required drivers for iTX are specially supplied by AJA and are included with the iTX Suite in the Drivers folder.
- For more information on SDI I/O cards for Output Server 2, see the *Output Server 2 Channel Configuration Guide*.

### To verify the current version of the AJA card drivers:

1. On the Windows desktop, right-click the **Computer** desktop icon and select **Manage** from the displayed menu commands. The **Computer Management** window appears.
2. **Within Computer Management (Local)**, select **Device Manager**. The **Device Manager** window appears.
3. Expand the **Sound, video and game controllers** category.
4. Right-click **AJA Corvid SDI I/O** or **AJA KONA 3G SDI I/O** and select **Properties**.  
  
The Properties window for your model of AJA card opens.
5. Select the **Drivers** tab and take note of the version number.

## Installing the drivers

The SDI video card in an Output Server or Encode Server machine requires the correct device driver. Grass Valley supply drivers for supported cards in the installation folder, iTX Suite. The drivers are contained in a Zip file in the Drivers folder:

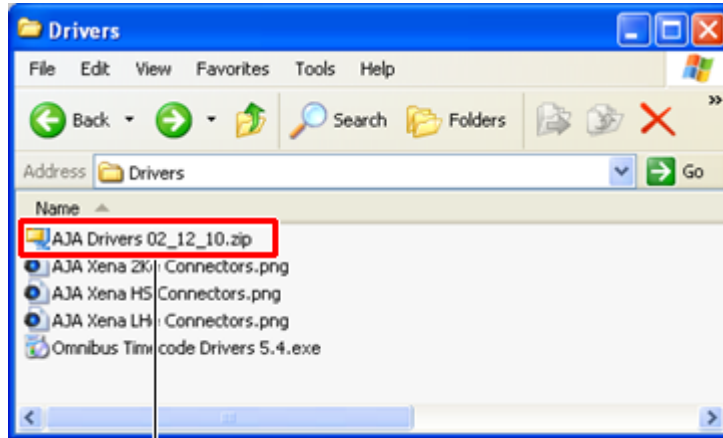

AJA-drivers Zip file

When you extract the Zip-file contents, various unzipped files appear in three folders. One of the folders, called 1 - Drivers, has subfolders containing the driver installation files for different types of video card:

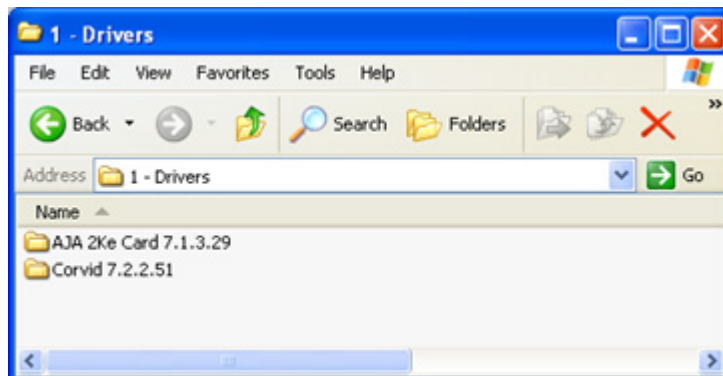

The drivers are for the Xena 2Ke and the Corvid SDI video cards.

1. After copying the iTX Suite folder to a machine, unzip the AJA Drivers Zip file.
2. Install the required driver in one of the standard ways, depending on how the operating system that is running on the machine responds to the presence of the SDI video card.

For example, start the Windows device-driver installation wizard from the Device Manager control panel. See below, "Steps to follow when using the Hardware Update Wizard".

When prompted to specify the driver that is to be installed, select it from one of the folders. Drivers are identified by files with the filename extension ".inf".

3. Restart the machine.

## Steps to follow when using the Hardware Update Wizard

You may use the Windows Hardware Update Wizard to find the driver for an SDI video card, so that the system can install it. To start the wizard, you right-click the entry for the 'unknown' video card in the Device Manager list and select **Update Driver** from the displayed menu:

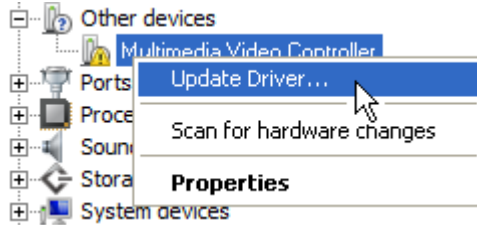

Select the following options on the various dialogs as you use the wizard.

- Decline the offer for the wizard to get the driver from Windows Update:

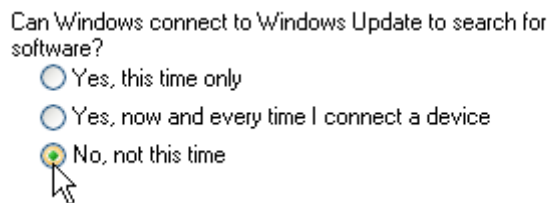

- Select the option to install the driver from a specific location:

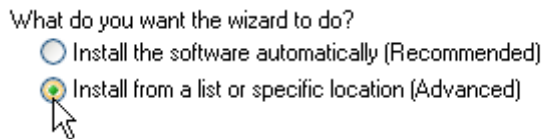

- Prevent Windows from searching for the driver:

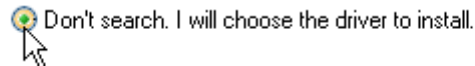

- Select Have Disk:
- Instead of following the wizard instruction to insert a disk, click **Browse** and navigate to the correct subfolder in the Drivers folder.
- Select the driver (.inf file).

The system displays a security message, requesting whether or not you want it to install the driver.

- Click **Install**.

The system installs the driver and displays a dialog to show the installation is complete.

- Close the dialog and check the entry for the driver in the Device Manager list:

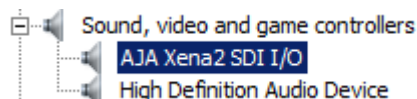



## Installing iTX software modules

In this section, following some general installation notes and a pre-installation check list, we explain how you use the iTX installer to install individual software modules on iTX machines.

Configuration instructions appear in the following sections.

### Installation notes

- You install a software module by double-clicking the icon of the iTX installer, **Setup.exe**, selecting the module and responding to on-screen prompts.
- Each module contains a number of program files.
- During the installation process, the installer places the program files in their own folder at a specified location. The default path of this location is:  
C:\Program Files (x86)\iTX 2.0\Services
- A program folder contains the program executable, *programname.exe*, and a configuration file, *programname.exe.config*.
- All modules for iTX services include a Server Controller. iTX uses Server Controllers to start the services automatically and keep them running.
- The iTX installer registers each service with the Server Controller, on the same machine, and causes the service to display a user interface. (The user-interface property is denoted by the entry "-ui" in the Startup Parameters column under the Controlled Services Information tab of the Server Controller window.)
- You configure the services via dialogs during installation. Some services require additional configuration after you install them.
- On each machine that has a Server Controller, the iTX installer installs an extra service called the iTX Software Updater. This service enables you to upgrade all iTX servers from your system-administrator workstation. (You may choose not to have the service installed if you do not want to use this feature.)

### Pre-installation check list

Below, we list key tasks that need to be done before you install iTX software modules. When you can enter ticks in the "Done" column against each task, your system is ready for the installation of these modules.

Task	Done (✓)
Connect the iTX machines to the network.	
Ensure the Database Server machine has a static IP address.	
If your system uses a WINS or DNS server, enter the Database Server IP address for the host name "omn-locator".	(If applicable.)
On the Media Store, create Media and Inbox folders.	

Task	Done (✓)
In each Output Server and Encode Server machine, insert a License dongle.	
On each Output Server and Encode Server machine, install the video-card driver.	
On each Output Server, create a cache for media files.	
Install and configure Microsoft SQL Server on the Database Server; specify the password we supply for the SQL Server log-in password.	
If you are going to use a VITC generator to provide a reference time signal, connect the VITC feed to a machine in the system.	(If applicable.)

## Running the iTX installer

### Start the iTX installer

1. Download the zip file from the Grass Valley website and copy it to the computer you wish to install iTX on.
2. Depending on the security settings of your computer, you might need to make sure that the installation process will not be blocked as potentially dangerous. Right click the zip file and select 'properties'.
3. From the properties menu, select the 'General' tab. If the computer is configured to block the installation of files that could be harmful, the bottom section of the menu will have a Security statement: "This file came from another computer and might be blocked to help protect this computer".

Click 'unlock'. Click OK.

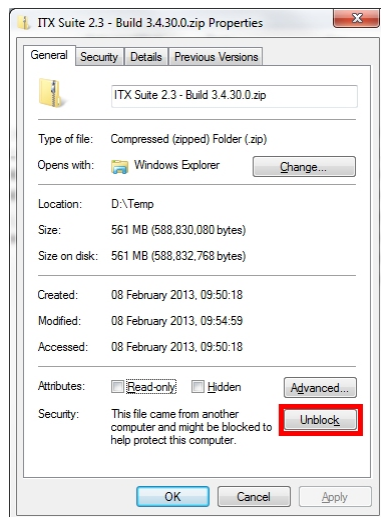

4. Extract the zip file's contents into the directory you wish to install the software from.

**Note:**

- You must be logged on to the local machine with administrative user rights in order for the installation process to continue successfully.

- Open the iTX suite folder and right-click **Setup.exe**. Select 'Run as Administrator' if this option is available. If not, simply double-click the Setup.exe to begin the installation process.

The installer checks to see whether or not the pre-requisite software is installed on the machine.

If the pre-requisites are installed, the installer displays the Select Software To Install dialog:

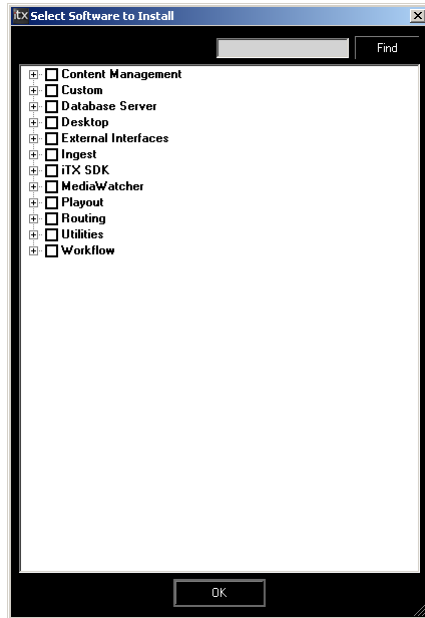

The dialog displays a list of available software modules. The modules are arranged in categories, depending on the type of functionality they provide.

A category is indicated by a name in a bold typeface. Clicking the check box before a category entry expands the entry to show the modules in the category. Some categories contain sub-categories (also indicated by names in bold typeface).

Modules are indicated by names in a regular typeface.



You use the check boxes to select the modules you want to install.

When you select a module, its entry expands to show a list of the components the module contains:

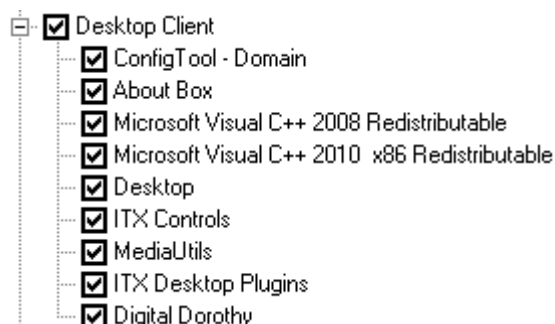

Clicking  or  expands or collapses a list of components.

You may clear the check boxes of components you do not want to install.

Clicking **OK** displays the main iTX Installer dialog (see below). From this, you start the installation. While installing a software module, the installer may prompt you to enter certain configuration details.

**Note:**

- To change your selection of software modules at any time, you may display the Select Software to Install dialog from the main iTX Installer dialog.

## About the installer configuration file

The installer records what iTX software modules it installs on a machine; it enters the details in a configuration file which it stores on the machine. The file is stored in an application-data folder under the logged-on username.

You may re-run the installer; for instance, to upgrade or uninstall any software module. When you do, the installer checks the configuration file and automatically selects the same software modules. It displays the selection in the Select Software To Install dialog.

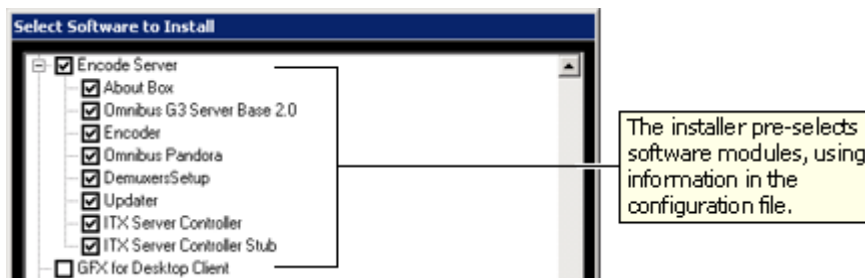

You may accept or change the selection, before allowing the installer to continue its operations.

You can delete the configuration file by clicking **Delete Config** in the iTX Installer dialog. Doing so prevents the installer from pre-selecting modules for the next installation.

## About the main iTX Installer dialog

After you select a software module in the Select Software To Install dialog, the installer displays the iTX Installer dialog, showing the components in the module:

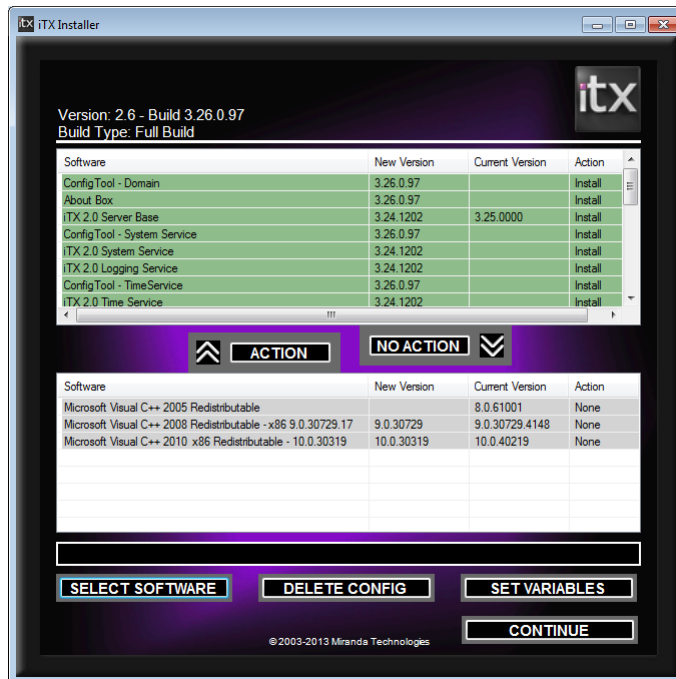

It sorts the components into two lists: an action list in the upper half of the dialog; a no-action list in the lower half.

The action list contains components that the installer is going to take specified action on; the no-action list, components that it is not going to take any action on.

You may use the **Action** and **No Action** buttons to move selected components from one list to the other.

The first time you run the installer on a particular machine, all software components in selected modules are selected for installation. They appear in the action list; the no-action list is empty.

### Note:

- We recommend you accept the default selection for the first installation of a software module.

## Running the iTX installer to upgrade or modify an installation

When you re-run the iTX installer after installing any iTX software module, the iTX Installer dialog appears (instead of the Select Software To Install dialog). The dialog displays details of installed components; these appear in the no-action list if the installed versions match those in the installation folder; or in the action list (together with any new components requiring installation) if the installation folder contains later versions.

You may use the buttons at the bottom of the dialog when upgrading software, changing the usage of a machine or re-configuring a machine for a different System Database:



Click:

- **Select Software** to display the Select Software To Install dialog.
- **Delete Config** to delete the configuration file. You should uninstall any installed modules first.
- **Set Variables** to change the System Database connection details. Since the System Database details do not usually change in the lifetime of a system, it is unlikely you will need to use this button.

## Setting up an iTX domain and load-balanced Locator Services

iTX services and clients (including iTX Desktops) on the same TCP/IP network can interact with each other if they are in the same iTX domain. An iTX domain is identified by a domain name assigned to machines on which iTX software runs.

In general, iTX services and clients belong to the same iTX domain if they run on machines that have the same iTX-domain name.

You assign a domain name to a machine during the installation of the first iTX software module on the machine. You do so when the installer displays the iTX Domain Configuration dialog:



There is almost no limit to the possible length of a domain name; but for practical reasons the name should be short – containing a maximum of about 10 characters. It should clearly distinguish the domain from other iTX domains. You may include any character apart from a colon (:) in the name.

Through the same dialog, you may specify a Locator Service – or a group of load-balanced Locator Services – for the domain. You add the Locator Services to a list in the Locators panel, which appears when you select **Use Locator Service**:

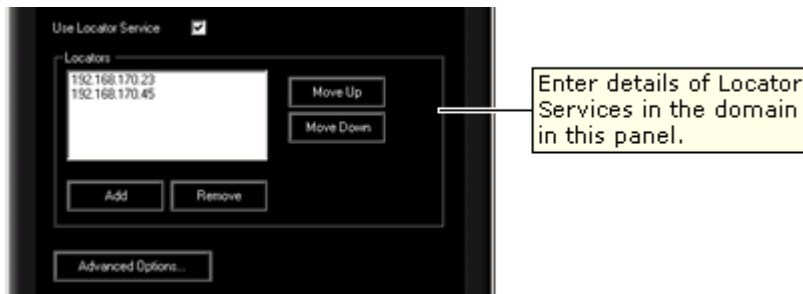

The order of Locator Services in the list determines the order in which iTX selects them to handle connection requests: a service that requires connection details contacts the Locator Service at the top of the list; if this one is busy, the next in the list; and so on.

The list should be the same for each Locator Service in a load-balanced group.

When you save the configuration, the installer performs a number of actions. It:

- Enters the domain name in the Windows registry. iTX services and the iTX Desktop get the domain information from the registry when they start up.
- Creates a domain configuration file, containing domain and Locator Service details. It stores this in an application-data folder under the logged-on username.
- Creates a Locator-mode configuration file, Omnibus.config, indicating whether or not iTX is to use the Locator model for service and client connections. It stores this in the iTX program folder.
- Adds Locator Service details to the machine Hosts file.

Do the following to enter domain and Locator Service details through the iTX Domain Configuration dialog.

1. In the **iTX Domain** box, enter a name for the iTX domain that the iTX services are to operate in.
2. Select **Use Locator Service** to display the Locators panel.
3. Do the following to identify a machine with a Locator Service.
  - Click **Add** to display the Add Locator dialog.
  - Enter the IP address of the machine.
  - Click **OK** to close the Add Locator dialog.

The machine IP address appears in the Locators panel.

4. Repeat the previous step to add details of any other Locator Services (in the same domain) that you want to use for load balancing.
5. Use the **Move Up** and **Move Down** buttons to change the position of any Locator Service in the list.
6. Click **Save**.

The installer saves the configuration; the iTX Domain Configuration dialog closes.

**Note:**

- The Advanced Options button on the iTX Domain Configuration dialog displays a range of settings that should only be modified by Grass Valley engineers.

- You may use the Domain Configuration tool to modify the configuration after the installation of software. [More details](#), page 48.

## Install the Database Server module

Once you have installed Microsoft SQL Server and the pre-requisite software on the Database Server machine, you can install the Database Server module. The procedure below includes the installation of the optional Locator Service module – we recommend you install a Locator Service for most systems; the service is essential for multi-domain systems.

To ease the workload on this Locator Service, you may install Locator Services on other machines in the same domain. All Locator Services then perform similar tasks in a load-balanced arrangement.

In general, two load-balanced Locator Services meet the requirements of most systems.

### Note:

- For the installer to be able to perform the required tasks in SQL Server during the installation of the Database Server module, the user account you use must be a member of the dbcreator fixed server role in SQL Server; it must also be a member of the sysadmin fixed server role. (You give the user account these roles in Microsoft SQL Management Studio).

1. Double-click **Setup.exe** to start the iTX installer.

2. Select **Database Server** and **Locator Service** from the Select Software To Install dialog.

If you want to install the Media Watcher (with iTX Desktop layouts) at the same time as the Database Server module, also select **Media Watcher**.

Click **OK** to close the dialog.

The installer displays the iTX Installer dialog, showing the components in the selected modules.

3. Click **Continue**.

The installer performs the installation. The progress bar at the bottom of the dialog shows the operation progressing.

The installer installs the System Database schema and some iTX services.

4. For some tasks, the installer displays a dialog requesting you to enter certain system details. We describe how to use these dialogs below.

5. In the iTX Domain Configuration dialog, enter domain and Locator Service information. [More details](#), page 32.



The Create Database dialog:



6. Check "ITX" appears in the Database Name box. This is the required name of the iTX System Database; it is not case-sensitive.
7. Check the network name of the Database Server machine appears in the Database Server box.
8. In the Database Location box, enter the path to the folder where you want the installer to install the iTX System Database. This folder may be one created during the installation of the SQL Server.

**Note:**

- The System Database and program files should be installed on different drives.
9. If the system design includes a backup (or mirror) SQL Server, enter the network name of the backup machine in the Backup Database Server box.
  10. To set up iTX to access the SQL Server through the user account that you are using for the installation, leave the Use Trusted Connection check box selected.
  11. If you want to specify a different user account for iTX to use when accessing the SQL Server, clear the Use Trusted Connection check box; enter the account details in the User ID and Password boxes.
  12. Click Save. The Create Database dialog closes.

The installer creates the iTX System Database on the Microsoft SQL Server.

## Installing the iTX Database on a Remote Server

In earlier versions of iTX, it was normal procedure to install the Locator Service, Media Watcher and any framework services you require on the same server as the iTX Database, particularly on a small system.

Previously, if you wanted to install the Locator Service (along with any other Frame Work Services) on a different server to the Database Server, you would have to carry out the procedure on each of the relevant machines.

With iTX 2.4, you can now install the iTX Database simultaneously on a remote server while installing other Framework Services locally. Both servers must be in the same network domain.

To use this option, enter the database details in the Create Database dialog as detailed below, but instead of entering the name of the local server, you enter the name of the remote server on the network. You then specify the designated drive that you wish to install the database to in the usual way.

**Note:**

- For a remote database installation to be successful, you must be logged on to the local server with a user account that also has administrative rights for the database server.

If remote installation encounters a problem, the dialog will now display an error along with a button labelled “OpenDBTool.log”. Clicking this button will open the database install log to help identify the problem the installation encountered.



The Add Tables to Database dialog:

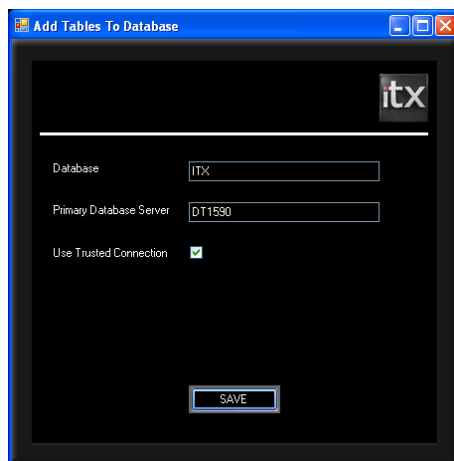

- Check the name of the newly created System Database appears in the **Database** box.
- Check the network name of the Database Server appears in the **Primary Database Server** box.
- Specify the database connection method (i.e. by trusted or named user).
- Click **Save**. The Add Tables To Database dialog closes.
- The installer adds the iTX tables to the System Database.

The Database Configuration dialog:

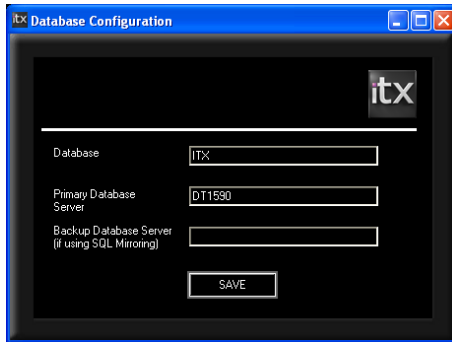

Through this dialog you provide the information the System Service needs to connect to the System Database.

- Check the correct name appears in the **Database** box.
- Check the network name of the Database Server appears in the **Primary Database Server** box.
- If the system includes a backup SQL Server, check the correct name appears in the **Backup Database Server** box.
- Click **Save**. The Database Configuration dialog closes.

The installer creates a configuration file, containing the details you enter, in an application-data folder under the logged-on username.

The Time Service Config dialog:



- In the **Time Service Format** box, select the television standard that specifies the frame rate iTX is use for its output.
- Click **Save**. The Time Service Config dialog closes.

The installer creates a configuration file, containing the details you enter, in an application-data folder under the logged-on username.

Following the installation of the System Database, the OPUS2 Service Configuration dialog:

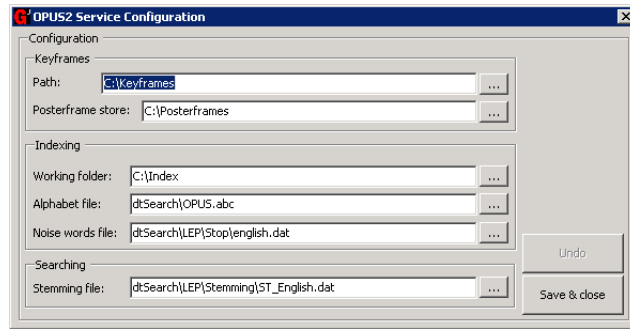

- In the **Path** box, under Keyframes, enter the path to the folder where the OPUS2 Service is to find keyframes. In the **Posterframe store** box, enter the path to the folder where the service is to find poster frames.
- In the **Working folder** box, under Indexing, enter the details of the folder for the Search index.
- Click **Save & Close**.

The Add Tables To Database dialog appears for two more services: the OPUS2 Service and the Routing Data Service. Each time it does, you need to enter the same information as you do when it first appears (for the System Service) to continue the installation.

The installer completes the installation of the Database Server and Locator Service modules.

If you include the Media Watcher module in the installation, the installer next starts to install the module. During this process, you need to specify options through the Media Watcher Configuration dialog; the procedure is the same as if you are installing the Media Watcher on a stand-alone Media Store. [More details](#), page 39.

When installing the Media Watcher, the installer copies the iTX Desktop layouts to a Media Watcher folder. (When the Media Watcher starts for the first time, it copies the iTX Desktop layouts to the System Database so that they become available to use at iTX Desktop workstations.)

13. Click **Finish** to close the iTX Installer dialog.

On successful installation of the Database Server and Locator Service modules, folders for the installed components appear in the Program Files\iTX 2.0\Services folder:

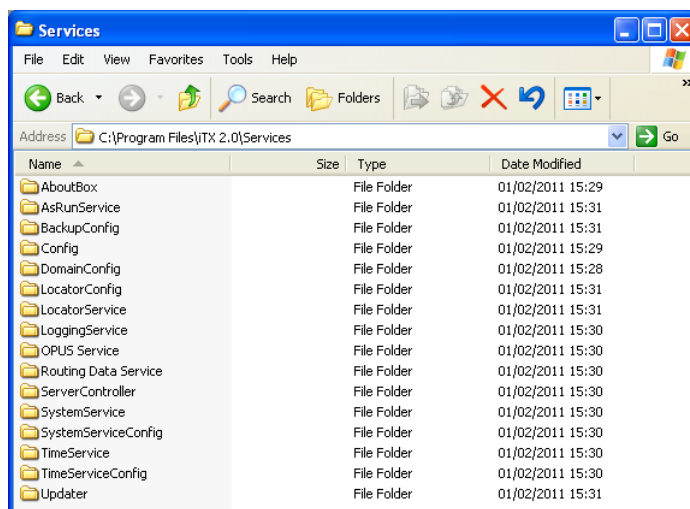

The installed services are:

- The Server Controller
- The System Service
- The Logging Service
- The Time Service
- The OPUS 2 Service
- The As Run Logging Service
- The Routing Data Service
- The Locator Service
- The iTX Software Updater

If it is included in the installation:

- The Media Watcher

## Install the Media Watcher on a stand-alone Media Store, or other machine

There must be at least one Media Watcher in an iTX system, to monitor the Inbox on an iTX Media Store. This Media Watcher registers the media files, and other valid files, that are placed in the Inbox; it rejects files that iTX cannot use.

In certain circumstances, it may also be used by a Media Cache Service to copy files so that they are available for playout. [More details](#), page 251.

There may be other Media Watchers in a system, doing the same jobs for different Media Stores and Output Servers.

You should install the only or main Media Watcher on the machine that is to be the main Media Store; this may be the Database Server machine or, more likely, a stand-alone Media Store. If it is not possible to run the Media Watcher on a stand-alone Media Store, you may install it on the Database Server machine.

Perform the following procedure to install the Media Watcher and iTX Desktop layouts on a stand-alone Media Store or other machine.

**Note:** If you want to install the Media Watcher on the Database Server machine, do this at the same time as you install the Database Server module. See "Install the Database Server module", page 34.

1. Double-click **Setup.exe** to start the iTX installer.
2. Select **Media Watcher** from the Select Software To Install dialog.

Click **OK** to close the dialog.

The installer displays the iTX Installer dialog, showing the components that make up the Media Watcher module.

3. Click **Continue**.

The installer performs the installation. For some tasks, it displays a dialog requesting you to enter certain system details. We describe how to use these dialogs below.

In the iTX Domain Configuration dialog, enter domain and Locator Service information. [More details](#), page 32.

The Media Watcher Configuration dialog:

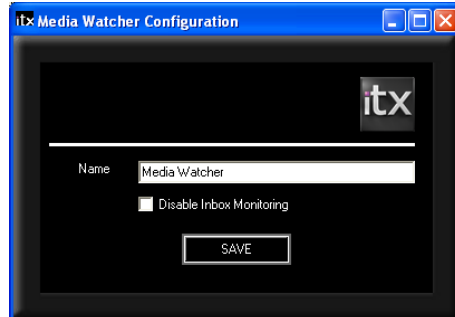

- For the main Media Watcher, ensure the name in the **Name** box is "Media Watcher". Enter different names for other Media Watchers.
- Ensure the **Disable Inbox Monitoring** check box is not selected.
- Click **Save**.

The installer creates a configuration file, containing the details you enter, in an application-data folder under the logged-on username.

It completes the installation of the Media Watcher and copies the iTX Desktop layouts to a Media Watcher folder.

4. Click **Finish** to close the iTX Installer dialog.

On successful installation of the Media Watcher module, folders for the installed components appear in the Program Files\iTX 2.0\Services folder. The installed services are:

- The Media Watcher
- The iTX Software Updater

## iTX Desktop layouts

During the installation of the Media Watcher, the installer places a set of iTX Desktop layouts in a Zip file in the Media Watcher program folder.

On first starting, the Media Watcher registers the layouts and stores them in the System Database. With a folder structure representing the organisation of data in the System Database, the layouts are located in a Templates folder.

### Note:

- If you run the installer to upgrade the Media Watcher, the Media Watcher overwrites existing Templates layouts with any new ones that have the same names.

## Configuring a Media Watcher after installation

After installing a Media Watcher, you may need to modify its configuration. You do this under the Setup tab of its user interface, which the Media Watcher displays while it is running.

You can specify extra folders for media-file storage, and other folders for the Media Watcher to search when caching or mirroring. [More details](#), page 73.

## Install an Output Server module

iTX offers two versions of the Output Server module. Output Server 1 (OS1) and Output Server 2 (OS2).

Introduced in iTX v2.5, Output Server 2 is Grass Valley's next generation iTX video engine and while it supersedes the previous video engine, Output Server 1 is still supported. Although you cannot run Output Server 1 and Output Server 2 on the same playout server, due to the AJA SDI I/O card driver requirements of each, it is possible to run both video engines within the same iTX System on different playout servers.

### Note:

- The steps below outline the process of installing Output Server 1. For information on Output Server 2 refer to the *Output Server 2 Channel Configuration Guide*.

Whether you are using Output Server 1 or Output Server 2, you install an Output Server module on each machine that is to provide a playout channel. The module is suitable for either standard-definition (SD) or high-definition (HD) output; you configure the channel resolution after installing the service.

You also install an Output Server module on each machine that is to render the content of a schedule as media for on-demand video.

Services in the Output Server modules need authentication from a License dongle before they can run.

For information on migrating between Output Server 1 and Output Server 2 see the *Output Server 2 Channel Configuration Guide*.

### To install an Output Server module:

1. Double-click **Setup.exe** to start the iTX installer.
2. Select **Output Server** from the Select Software To Install dialog.

Click **OK** to close the dialog.

The installer displays the iTX Installer dialog, showing the components that make up the Output Server module.

3. Click **Continue**.

The installer performs the installation. For some tasks, it displays a dialog requesting you to enter certain system details. We describe how to use these dialogs below.

In the iTX Domain Configuration dialog, enter domain and Locator Service information. [More details](#), page 32.

The Media Cache Configuration dialog:



A default name for the Media Cache Service appears in the **Name** box; this is formed from the machine name and the suffix "-CACHE". You may change this name, but you should ensure any new name is different from the names of all channels in the iTX system; it must also contain the "-CACHE" suffix.

- Enter a new name in the **Name** box, if you want to.
- If you have not already created a shared directory on the Output Server machine to cache your media to, click **Create Cache Share**.
- The following dialog box will appear:

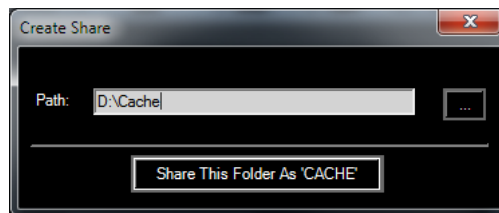

- You can either type the path and name of the folder you wish to use if you have already created it, or click the browse button to navigate to the location where you wish to create the share.
- Click the **Make New Folder** Button and name the new folder.
- Click **OK**.
- Click **Share This Folder As Cache**. The Create Share dialog will close, leaving the Media Cache Configuration dialog open.
- Click **Save**. The Media Cache Configuration dialog closes.

The installer creates a configuration file, containing the details you enter, in an application-data folder under the logged-on username. It configures the Server Controller on the Output Server machine to run the Media Cache Service.

The iTX Channel Config dialog will then appear in order for you to configure your channel (or channels if you are installing on an iTX Appliance Server).



## The iTX Channel Config dialog (Output Server 1 only)

The iTX Channel Config dialog appears towards the end of the Output Server 1 installation and is used to enter the basic details of the channels you want to run on the playout server.



- Enter a name for the playout channel in the **Unmodified Name** box. The installer repeats the name in the **Channel Name** box. The default name for a channel is iTX-1.
  - The name must be different to all other channel names and must not contain any spaces.
  - For a sub-channel used to play out regional content, the sub-channel name must have the same name as the primary channel followed by #*n*, where *n* is the number of the sub-channel (1-8). For example, iTX1#4 is sub-channel 4 of the primary channel iTX1.

**Note:** You must restart TXPlay on the Output Server for the primary channel after a sub-channel is added to the iTX system.

The installer automatically enters names (based on the unmodified name) for any other type of channel – back-up, edit or live – that you specify in the dialog.

- Select **Backup** if you want the installer to create a back-up channel. The installer adds “-BACKUP” to the channel name.
- From the **Playout** dropdown menu, select one of the following:
  - For the output of content to a normal television transmission system using an AJA SDI video card, select **AJAXena**.
  - For a channel used to render the content of a schedule as media for video on demand, select **Render**. The installer adds “-RENDER” to the end of the channel name.
  - For an iTX On Demand channel, select **On Demand**.

- Select **Edit Channel** if you want the installer to create an edit channel; the installer automatically enters a name for the channel. This option is selected by default.
- Select **Live Channel** if you want the installer to create a live channel; the installer automatically enters a name for the channel. You should only select this option if there is a requirement for the ability to play out schedule events by using the Live Control on an iTX Desktop layout.
- Select **Live Record to File** if you want iTX to record selected live feeds as files when it plays them out. If you select this option, you need to specify file properties by setting an encode profile. [More details](#), page 178.
- Select the **IntegratedXG** option if the output server is an iTXG output server with Grass Valley Vertigo graphics software on board.
- Check **Use Dedicated Softel Driver** to enable the updated driver, which supports Softel Swift, TX Classic, Softel Swift mTX and Softel Swift mTX Multi-Language external subtitles. By default, the legacy Softel driver is enabled (the checkbox is clear).
- If the output server machine is an iTX Appliance Server, it is capable of running two channels (if fitted with two Xena video cards). If you wish to add a second playout channel, click **Add Extra Channel**. This will open the Add Extra Channel dialog box:

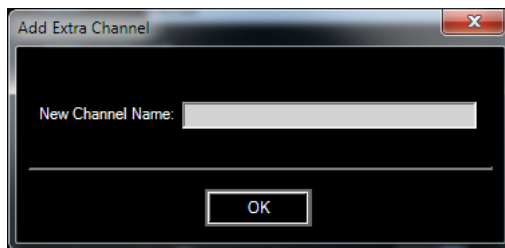

- Type the name of the second channel in the dialog box and click **OK**.
- The installer then returns you to the Channel Config Dialog. You can then select each channel in the **Unmodified Name** drop down selector and configure them individually, using the same steps detailed above. When both channels are configured, click Save.

**Note:**

- The device number dialog is automatically incremented when a second channel is added. This refers to which Xena card within the iTX Appliance server will be used for this particular channel.
- You can also use this dialog to delete a channel from the server if you no longer require it. Select the channel you wish to delete from the **Unmodified Name** dialog and click **Delete Channel**.
- When you have finished configuring your channel or channels, click **Save** and the iTX Channel Config setup will close.

The installer creates a configuration file, containing the details you enter, in an application-data folder under the logged-on username. It configures the Server Controller on the Output Server machine to run the various channel services.

This completes the installation of the Output Server module.

On successful installation of the Output Server module, folders for the installed components appear in the Program Files\iTX 2.0\Services folder. The installed services are:

- TXPlay
- TXEdit (optional)
- The Output Server

- The iTX Player
- The Media Cache Service
- The iTX Software Updater

## Configuring services on the Output Server machine after installation

Installation of the Output Server module creates a playout channel with a default set of properties. You should check these properties on the Channel Configuration pop-up layout at an iTX Desktop workstation; you may need to change them to suit your broadcasting requirements.

In particular, you may want to specify a standby slide and a breakdown slide – still images that iTX is to display when there is no schedule running in the channel, or if there is an unplanned interruption to a schedule.

[More details](#), page 130.

## Install a Desktop Client module

You need to install the Desktop Client module on any machine that is allocated for system administration and on all operator workstations.

By setting the security privileges through the iTX Security Tool, you can control the amount of functionality available at each iTX Desktop. On a system-administrator workstation, you should be able to make changes to the set-up of the iTX system. On an operator workstation, it should be possible for an operator to perform the required operational tasks.

1. Double-click **Setup.exe** to start the iTX installer.
2. Select **Desktop Client** from the Select Software To Install dialog.

Click **OK** to close the dialog.

The installer displays the iTX Installer dialog, showing the components that make up the Desktop Client module.

3. Click **Continue**.

The installer performs the installation. During this process, the installer displays a dialog requesting you for domain details.

In the iTX Domain Configuration dialog, enter domain and Locator Service information.

[More details](#), page 32.

The installer completes the installation of the Desktop Client module.

4. Click **Finish** to close the iTX Installer dialog.

## Check the connection of an iTX Desktop to the Media Store

To save schedules and preview video clips, each iTX Desktop workstation must have access to the Media folder on the Media Store.

1. From Windows Explorer, open the Media folder on the Media Store.

## Digital Dorothy files

On each iTX Desktop workstation, the installer installs a small application called Digital Dorothy. This application provides the voice counts that operators may listen to when iTX is counting down to, or up from, the start of an event. The counts happen at specified intervals; they correspond to the **Now** and **Next** timecode displays on the Channel Control layout.

The recordings for the voice counts are contained in .wav files which the installer places in a folder on the workstation. In the same folder, it places the files that control the timing of the counts. The default path to the folder is:

C:\Program Files\iTX 2.0\Applications\Desktop\Digital Dorothy

There are three timing-control files: CountIn.txt, CountOut.txt and CountTo.txt. In these, a single line sets each count. The line contains two elements, separated by a colon: the time (in seconds) of the count from the start of the event to which it applies; the name of the .wav file used for the count.

For example, the line for the count at 10 seconds from the start of the event reads:

```
10:10.wav
```

You may replace the existing recordings with ones of your own; you may edit the timing-control files to vary the count intervals.

## Install the Software Distributor module on a stand-alone machine

We recommend you install the Software Distributor module on the system-administrator machine; this enables you to upgrade system servers from your system-administrator workstation.

1. Double-click **Setup.exe** to start the iTX installer.
2. When the installer displays the Select Software To Install dialog, select **Software Distributor**.

Click **OK**.

The installer displays the iTX Installer dialog, showing the Software Distributor component selected for installation.

3. Click **Continue**.

The installer performs the installation. During this process, the installer displays a dialog requesting you for domain details.

In the iTX Domain Configuration dialog, enter domain and Locator Service information. [More details](#), page 32.

The installer completes the installation of the Software Distributor module.

4. Click **Finish** to close the iTX Installer dialog.

On successful installation of the Software Distributor module, a folder for the installed components appears in the Program Files\iTX 2.0\Services folder. The installed service is:

- The iTX Software Updater

## Install the Encode Server module

You install the Encode Server module on each machine that is to provide a recording channel. The module contains components – encode plug-ins – for different types of media card. The listed plug-ins in this illustration are for a Lynx audio card and AJA video card:

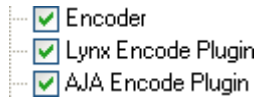

It does not matter how many of the plug-ins you select for installation, so long as you include the one required by the media card that iTX is to use for encoding. During the installation, you specify what type of card this is.

If the card is for video encoding, the installer sets up a single recording channel.

If the card is for audio encoding, the installer sets up eight recording channels, numbered 1 to 8. It gives the channels default names, which have two parts: the first part is a prefix, which you set during the installation; this is followed by “-REC# *n*”, where *n* represents the channel number.

Services in the Encode Server module need authentication from a License dongle before they can run.

1. Double-click **Setup.exe** to start the iTX installer.
2. Select **Encode Server** from the Select Software To Install dialog.

Click **OK** to close the dialog.

The installer displays the iTX Installer dialog, showing the components that make up the Encode Server module.

You may clear the check boxes of any plug-ins that iTX does not need.

3. Click **Continue**.

The installer performs the installation. For some tasks, it displays a dialog requesting you to enter certain system details. We describe how to use these dialogs below.

In the iTX Domain Configuration dialog, enter domain and Locator Service information. [More details](#), page 32.

The iTX Encoder Config dialog:



- In the **Channel Name** box, enter a name for the recording channel. This name must be different to all channel names in the iTX system; it must not contain any spaces. The installer automatically adds “\_REC” to the name, to indicate a recording channel.

- From the **Device** dropdown menu, select the type of video or audio card installed in the Encode Server machine.

The installer creates a configuration file, containing the details you enter, in an application-data folder under the logged-on username. It configures the Server Controller on the Encode Server machine to run the Encode Server: one instance for a video card, eight instances for an audio card.

It completes the installation of the Encode Server module.

4. Click **Finish** to close the iTX Installer dialog.

On successful installation of the Encode Server module, folders for the installed components appear in the Program Files\iTX 2.0\Services folder. The installed services are:

- The Encode Server
- The iTX Software Updater

## Importing encode presets

When performing a recording, an Encode Server creates a media file with properties that are defined in a template called an encode preset. We provide a number of encode presets in the installation folder. After installing the Encode Server module, you need to import the encode presets that are to be available for recordings. [More details](#), page 260.

## Re-configuring a service after installation

The iTX installer places a number of configuration tools in subfolders in the Services folder; it adds shortcuts to them on the Windows desktop. These tools display the configuration dialogs that appear when you install software modules; you can use them to change various configuration details.

You may use these tools to modify the various configurations:

### Database Server

- The Domain Configuration tool (DomainConfig.exe) to edit the domain name and Locator Service details.
- The System Service Configuration tool (ObjectDatabaseConfig.exe) to edit the database connection details.
- The Time Service Configuration tool (TimeServiceConfig.exe) to edit the setting for the time-service format.

### Media Watcher

- The Media Watcher Configuration tool (MediaWatcherConfig.exe) to edit the Media Watcher details.

### Output Server

- The Media Cache Configuration tool (MediaCacheConfig.exe) to edit the media-cache name.
- The iTX Channel Configuration tool (ITXChannelConfig.exe) to edit channel details.

### Encode Server

- The iTX Encoder Configuration tool (EncoderConfig.exe) to edit the recording-channel details.

## Creating a Locator domain configuration file

The iTX Locator Service maintains a list of all known services on the system. This could consist of services within the same iTX domain or ones running in separate iTX domains, each with its own group of playout channels. You can set up the latter systems for multi-domain operation, which makes it possible to move media files between domains and to control channels in one domain from an iTX Desktop in a different domain.

Each server in any of the iTX domains has to have at least one Locator Service. This service can then give information on the services that are running in its (local) domain to any Locator Service in another (remote) domain.

### Locator Service Config

For each Locator Service you need to create a domain configuration file, (DomainConfig.xml), containing details of the Locator Services in the same or other domains.

To create or edit the file, you use the Locator Service Configuration tool:

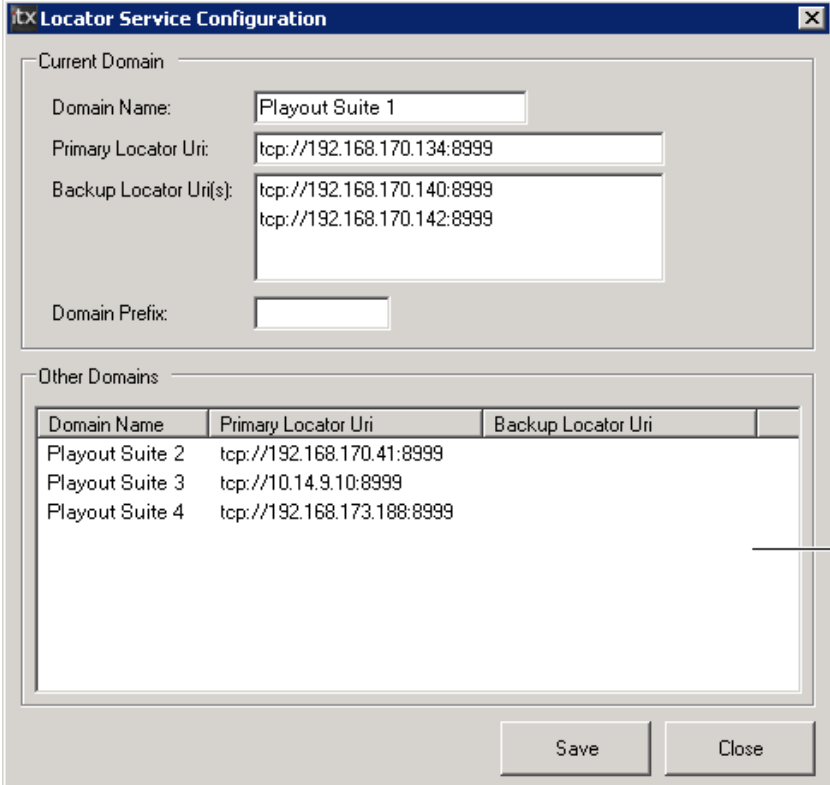

Domain Name	Primary Locator Uri	Backup Locator Uri
Playout Suite 2	tcp://192.168.170.41:8999	
Playout Suite 3	tcp://10.14.9.10:8999	
Playout Suite 4	tcp://192.168.173.188:8999	

This is installed with the Locator Service. You can display the tool from the Windows Start menu.

You need to list each Locator Service in the configuration tool of each server in the format:

```
tcp://255.255.255.255:8999
```

**Note:**

- You do not use the Locator Service Configuration tool to set up load-balanced Locator Services. You usually configure such an arrangement during installation of the software. If you want to modify the configuration, you use the Domain Configuration tool.

**About the DomainConfig.xml file**

The DomainConfig.xml file contains a domain section for the Locator Service in the local domain. The section has entries for the domain name, the address of the Locator Service, and the address of any back-up Locator Service.

For example:

```
<locatorService>
  <domain name="iTX1">
    <primaryUri>tcp://omn-locator:8999</primaryUri>
    <backupUri>tcp://backup-locator:8999</backupUri>
    <domainPrefix> </domainPrefix>
  </domain>
  ...
  ...
</locatorService>
```

The domain-name entry identifies the iTX domain that includes the primary Locator Service; the domainPrefix entry is not normally required by iTX.

For multiple back-up Locator Services, you can use comma-separated entries. For example:

```
<locatorService>
  <domain name="iTX1">
    <primaryUri>tcp://omn-locator:8999</primaryUri>
    <backupUri>tcp://backup-locator:8999,
      tcp://backup-locator1:8999</backupUri>
    <domainPrefix> </domainPrefix>
  </domain>
  ...
  ...
</locatorService>
```

The configuration file also contains an otherDomains section, with details for each remote domain that the Locator Service is to be able to get information from for its clients. This section should contain similar entries to those for the local domain; i.e. the domain name; the IP addresses of primary and back-up Locator Services.

For example:

```
<locatorService>
  <domain name="iTX1">
    <primaryUri>tcp://omn-locator:8999</primaryUri>
    <backupUri>tcp://backup-locator:8999</backupUri>
    <domainPrefix> </domainPrefix>
  </domain>

  <otherDomains>
  <domain name="iTX2">
    <primaryUri>tcp://192.170.0.200:8999</primaryUri>
    <backupUri>tcp://192.170.0.210:8999,
      tcp://192.170.0.215:8999</backupUri>
    <domainPrefix> </domainPrefix>
  </domain>
```



```

<domain name="iTX3">
  <primaryUri>tcp://192.168.120.100:8999</primaryUri>
  <backupUris>tcp://192.168.120.115:8999,
              tcp://192.168.120.121:8999</backupUris>
  <domainPrefix> </domainPrefix>
</domain>
</otherDomains>
</locatorService>

```

The information in the configuration file is displayed under the Domain Info tab of the Locator Service window.

## Create a DomainConfig.xml file

Using the Locator Service Configuration tool, do the following to create the configuration file. Ensure the Locator Service entries are in the same form as those in the example XML file above (e.g. tcp://omn-locator:8999; tcp://192.168.120.100:8999).

1. Enter the name of the local iTX domain in the **Domain Name** box.
2. Enter the details of the primary Locator Service in the **Primary Locator Uri** box.
3. Enter the details of any back-up Locator Services in the **Backup Locator Uri(s)** box.
4. Do the following for any remote iTX domains that you want the local domain to be able to connect to.
  - Right-click the Other Domains pane and select **Add New Domain** from the displayed menu. The Other Domain configuration window opens.
  - Enter the details of the remote domain in this window.
  - Click **OK**.

The configuration tool displays an entry for the remote domain in the Other Domains pane.

5. Click **Save**.

The configuration tool saves the configuration file in the Locator Service folder.

### Note:

- For most systems, you may leave the **Domain Prefix** box blank.
- You may delete or edit a remote-domain entry after right-clicking its name in the Other Domains pane and selecting **Edit Domain** or **Delete Domain** from the displayed menu.
- If you modify the configuration file while the Locator Service is running, you can update the service by clicking **Reload Config** under the Domain Info tab. You may need to restart the Locator Service to enable it to connect to any additional remote domains.

## Setting up services to start automatically on machine start-up

On each machine that runs iTX services (that is the Database Server, Output Servers, Encode Servers and any Media Store on which the Media Watcher is installed), an iTX application called the Server Controller starts these services.

If you want the services to start automatically when you start a machine and log onto the network, you need to add the program shortcut for the Server Controller to the Windows Startup folder. For instructions on how to do this, see the Microsoft Windows Help documentation.

If you do not set up the Server Controller to start automatically, you may start it manually from the Windows Start menu. Or you may create a shortcut on the Windows desktop and use this to start the program.

## Rolling back iTX modules

During testing of an iTX system, you may want to roll back to a previous version of the software. There are two methods of rolling back iTX modules, depending on whether you are rolling back to a major or sub release. .

As a general rule, you are rolling back to a previous major release if the first or second digit in the version number changes (e.g. v2.6 to v2.5 or v2.6 SP2 to v2.5.1). Prior to iTX 2.5, the third digit also constituted a major release indicator (e.g. v2.4.11 and v2.4.10 are both major releases).

Service packs constitute sub-releases (e.g. iTX 2.4.10 Service Pack 1, iTX 2.4.10 Service Pack 2, etc). From iTX 2.5 onwards, the third digit also constitutes a sub-release (e.g. v2.5.1), but this kind of sub-release are uncommon.

The table below provides examples of major and sub-releases of iTX:

Major releases versions	Sub-release versions
iTX 2.4.10	<ul style="list-style-type: none"> <li>• iTX 2.4.10 Service Pack 1</li> <li>• iTX 2.4.10 Service Pack 2</li> <li>• iTX 2.4.10 Service Pack 3</li> <li>• iTX 2.4.10 Service Pack 4</li> </ul>
2.4.11	No sub-release
2.5	<ul style="list-style-type: none"> <li>• iTX 2.5.1</li> </ul>
2.6	<ul style="list-style-type: none"> <li>• iTX 2.6 Service Pack 1</li> <li>• iTX 2.6 Service Pack 2</li> </ul>
2.7	No sub-release

### Rolling back to a previous sub-release

When rolling back a sub-release of iTX to a previous sub-release or to the initial major release of the same version (e.g. iTX 2.4.10 Service Pack 3 to iTX 2.4.10), it is possible to use the earlier iTX Installer to both uninstall the current version of the modules and re-install the earlier versions.

#### To roll back a sub-release:

6. Open the earlier iTX Installer, as described in “Installing iTX software modules” on page 27.

The iTX Installer dialog appears with a blank **Action** list (top half of the dialog), while the **No Action** list (bottom half of the dialog) contains the currently installed software.

The **Current Version** column lists the version number of the installed modules, while the **New Version** column lists the version number that will be installed, which will be an earlier version number.

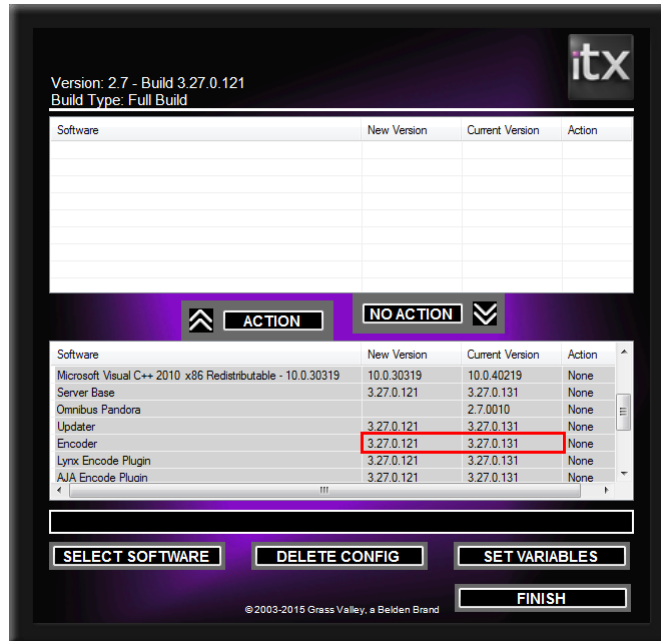

7. In the bottom half of the installer, select the modules you want to roll back. To select multiple modules, hold either the Ctrl key or Shift key while you select.
8. Click **Action**.  
The selected software appears in the **Action** list with a status of `Uninstall`.
9. Click **CONTINUE**.  
The newer version of the selected modules uninstall, then the **Action** list updates to show the earlier version of the modules with a status of `Install`.
10. Click **CONTINUE** again.  
The earlier version of the selected modules installs.
11. Click **FINISH**. The iTX Installer closes.

## Rolling back to a previous major release

To prevent potential conflicts between the underlying architecture of one major version of iTX and another, it is recommended that the newer version is uninstalled with its own installer. Then the modules can be re-installed using the earlier version of the installer.

### To roll back to a previous major version:

1. Open the iTX Installer for the current version of the installed modules.  
The iTX Installer dialog appears with a blank **Action** list (top half of the dialog), while the **No Action** list (bottom half of the dialog) contains the currently installed software.
2. Uninstall the current version of the modules.  
The current version of the modules can be uninstalled in the following ways:
  - Select the modules in the **No Action** list and click **Action**.

- Click **Select Software**, then uncheck the modules from the **Select Software to Install** dialog.
3. The **Action** list updates to display the modules with a status of `Uninstall`.
  4. Click **CONTINUE** to uninstall the modules.
  5. The newer version of the selected modules uninstall.
  6. Click **FINISH**. The iTX Installer closes.
  7. Open the iTX Installer for the previous version.
  8. Re-install the required modules, as described in “Installing iTX software modules” on page 27.

## Starting the iTX system services

To make the iTX system fully operational, you ensure all the system services are running; you then start the iTX Desktops.

To start the services on any machine, you should start the Server Controller on that machine and let the Server Controller start the services under its control. You should not start individual services manually.

Before you start the Server Controller on an Output Server or Encode Server machine for the first time, you should place a License file for the services on that machine in the Media Watcher Inbox folder; you should then check that the Media Watcher processes the License file.

### Start the system services

1. Start the system services on the iTX machines in this order:

- Database Server machine.
- Media Stores.
- Output Server machines.
- Encode Server machines.

If the Windows Startup folder contains a shortcut for the Server Controller, the Server Controller starts automatically when the machine starts up.

To start the Server Controller manually, select **Server Controller** from the Windows Start menu; or double-click a shortcut, if there is one, on the Windows desktop.

The Server Controller starts; it then starts all the iTX system services on its machine.

## Checking the Server Controllers

When a Server Controller starts, it displays a user interface. This takes the form of a window, which you can move and resize. The Server Controller immediately starts the iTX system services under its control. For each service, a selection button appears in the Windows taskbar.

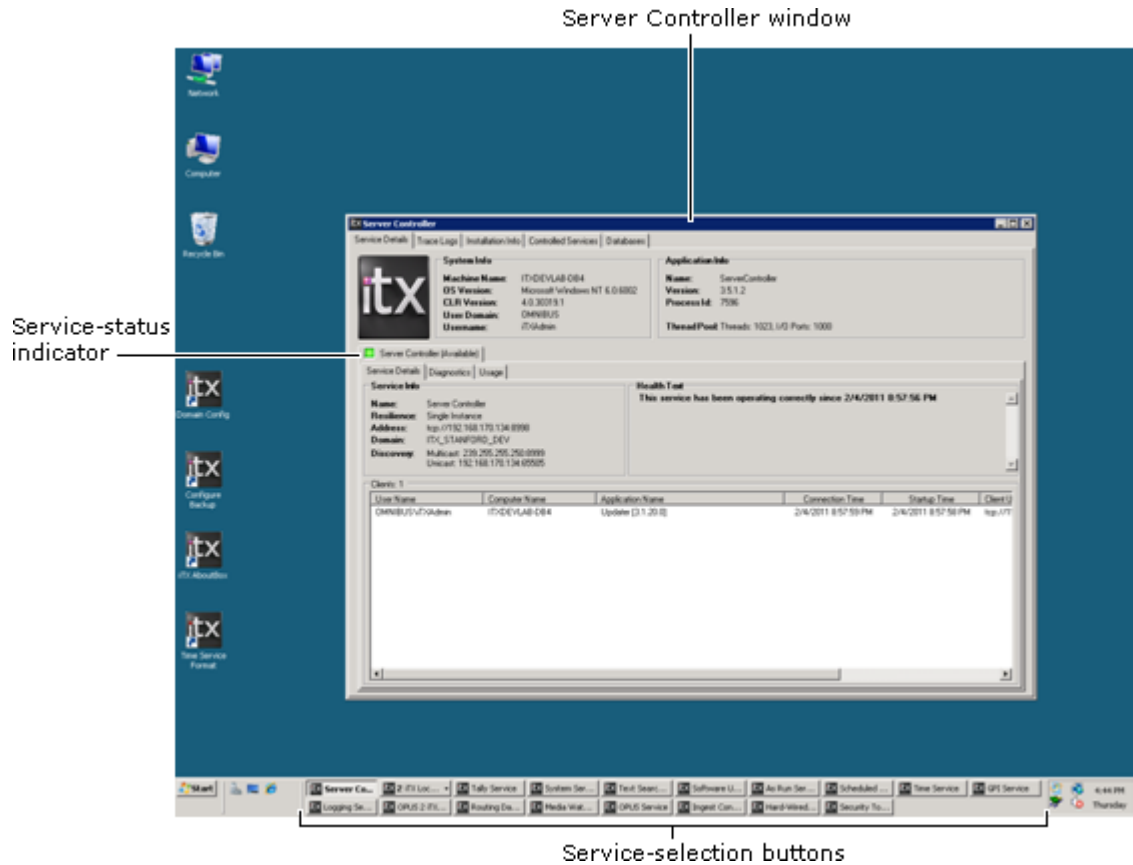

In a Server Controller window, the information is arranged under a number of main selection tabs: **Service Details**, **Trace Logs**, **Installation Info**, **Controlled Services** and **Databases**.

For more information about the Server Controller window, see the section "Running iTX services", page 210.

1. On each machine that the system services run on, check that the status indicator in the Server Controller window has a green light:

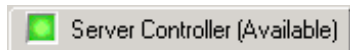

This shows that the program is running normally.

The indicator is visible in the window's default view (i.e. with the **Service Details** main tab selected).

- Click the **Controlled Services** tab to display a list of all the services running under the control of the Server Controller:

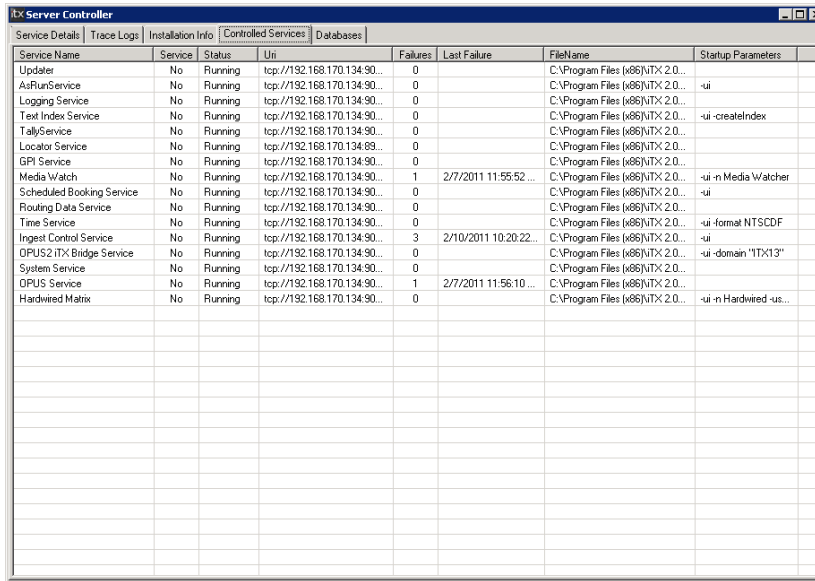

Service Name	Service	Status	Uri	Failures	Last Failure	FileName	Startup Parameters
Updater	No	Running	tcp://192.168.170.134:90...	0		C:\Program Files (x86)\iTX 2.0...	
AsRunService	No	Running	tcp://192.168.170.134:90...	0		C:\Program Files (x86)\iTX 2.0...	-ui
Logging Service	No	Running	tcp://192.168.170.134:90...	0		C:\Program Files (x86)\iTX 2.0...	
Task Index Service	No	Running	tcp://192.168.170.134:90...	0		C:\Program Files (x86)\iTX 2.0...	-ui -createIndex
TallyService	No	Running	tcp://192.168.170.134:90...	0		C:\Program Files (x86)\iTX 2.0...	
Locator Service	No	Running	tcp://192.168.170.134:90...	0		C:\Program Files (x86)\iTX 2.0...	
GPI Service	No	Running	tcp://192.168.170.134:90...	0		C:\Program Files (x86)\iTX 2.0...	
Media Watch	No	Running	tcp://192.168.170.134:90...	1	2/7/2011 11:55:52...	C:\Program Files (x86)\iTX 2.0...	-ui -n Media Watcher
Scheduled Booking Service	No	Running	tcp://192.168.170.134:90...	0		C:\Program Files (x86)\iTX 2.0...	-ui
Routing Data Service	No	Running	tcp://192.168.170.134:90...	0		C:\Program Files (x86)\iTX 2.0...	
Time Service	No	Running	tcp://192.168.170.134:90...	0		C:\Program Files (x86)\iTX 2.0...	-ui -format NTSCDF
Ingest Control Service	No	Running	tcp://192.168.170.134:90...	3	2/10/2011 10:20:22...	C:\Program Files (x86)\iTX 2.0...	-ui
OPUS2 iTX Bridge Service	No	Running	tcp://192.168.170.134:90...	0		C:\Program Files (x86)\iTX 2.0...	-ui -domain "iTX13"
System Service	No	Running	tcp://192.168.170.134:90...	0		C:\Program Files (x86)\iTX 2.0...	
OPUS Service	No	Running	tcp://192.168.170.134:90...	1	2/7/2011 11:56:10...	C:\Program Files (x86)\iTX 2.0...	
Hardwired Matrix	No	Running	tcp://192.168.170.134:90...	0		C:\Program Files (x86)\iTX 2.0...	-ui -n Hardwired -us...

Check that, for each service, the entry in the Status column reads "Running".

In a basic iTX system, these services should be running on the various machines:

Machine	Service
Database Server	System Service Locator Server (optional) Logging Service Time Service OPUS 2 Service As Run Service Routing Data Service iTX Software Updater
Output Server	TXPlay TXEdit Output Server iTX Player Media Cache Service iTX Software Updater
Encode Server	Encode Server iTX Software Updater
Media Store	Media Watcher iTX Software Updater

## Checking the iTX system services

Each service, running under the control of a Server Controller, displays the same type of user interface. Like the one for the Server Controller, this takes the form of a window that you can move and resize. This illustration shows a System Service window:

Service-status indicator

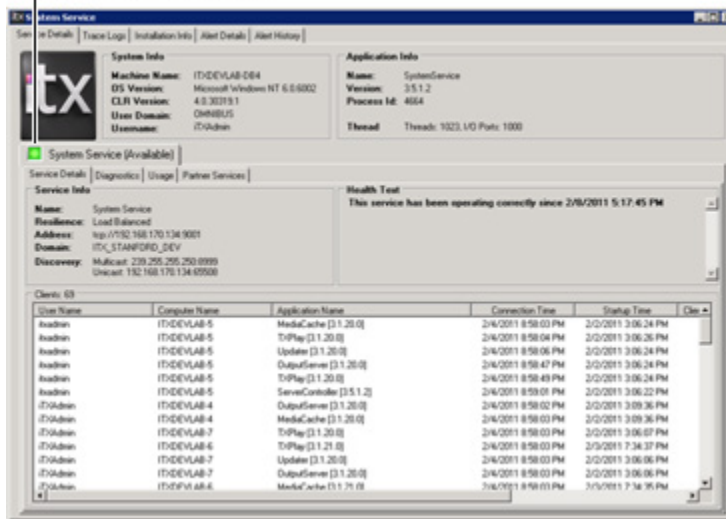

For more information about the user interfaces of the system services, see the section "Running iTX services", page 210.

- For each service, check that the status indicator has a green light, showing that the service is running normally:

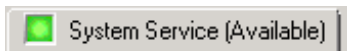

The indicator is visible in the window's default view (i.e. with the **Service Details** main tab selected).

- For each Output Server machine, check the License status boxes in the TXPlay and TXEdit user interfaces:

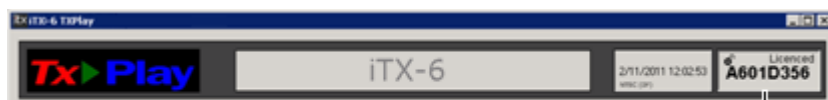

Licence-status box

These should show that the services are licensed.

**Note:** The two services share the License. If only one of them appears licensed, close the window of the 'unlicensed' service to stop the service. The Server Controller then restarts the service and iTX applies the License.

- Check the License-status box of any Encode Servers that are installed in your system.

## Adding users to the security system

All operators of the iTX system must be registered with the security system of the System Service. You should use the Security Tool (installed with the System Service) to:

- Add users to the security system.



- Arrange the users in groups.
- Assign security attributes to your system-administrator account (see the note below) and to the groups.

[More details](#), page 60.

**Note:**

- Your system-administrator account should have the security attributes of Desktop Administrator and Desktop Author assigned to it. These give you the rights to set up iTX Desktop layouts and make them available to operators. Operator user accounts, in general, should not have these security attributes.

# Security in an iTX system

## The security system of the iTX System Service

The iTX System Service operates a security system for checking the rights of operators who log onto iTX Desktops to use the system content – or “assets” (video clips, schedules, etc.). This enables iTX to manage security in two ways:

- **Access permissions.** iTX controls access to information that is stored in the System Database; it gives authorised users access to assets; it denies such access to unauthorised users. To make this possible, the security system keeps a list of permissions for all assets. The list contains details of which registered groups, users, computers and applications have access, of any defined type (e.g. read or write), to each asset.
- **User rights.** iTX controls what tasks users can perform with the assets that they have access to; e.g. some users may have the right to delete media files.

The security system does not directly allow or deny any user or computer the use of any asset. Instead, it authenticates users and computers (i.e. checks their credentials) at the request of other iTX services and applications. The requesting service or application then determines whether or not to allow a user or computer to use its functionality on the asset.

### Users

iTX Desktop users log onto an iTX system with their Windows-network user accounts, which have associated user rights. Before they can do this, you have to manually register the users in the security system. In doing so, you create user accounts and set security options for them.

- The user names (logon IDs) for these accounts must be the same as the user names in the Windows network.
- You do not need to set passwords in the security system for the new accounts.

Any non-registered user that logs onto the iTX system does so as a guest user; there is a special user account for this. By default the guest user has very limited user rights, which you may change.

You can withdraw access rights from any registered user. You may do this temporarily, by disabling the user account; or permanently, by deleting the user account.

### Groups

Access permissions and user rights may be assigned to individual users, computers and applications, or to any defined group of these as a whole. A group may contain any number of users, computers, applications and other groups.

The easiest way to set identical security options for multiple users is to create a group containing these users and set the security options for the group.

The security system keeps three permanent groups – Everyone, Users and Administrators.

- All registered users and the guest user are members of the Everyone group.
- All registered users are members of the Users groups.

- The Administrators group contains a built-in administrator; other users who require the same administrative rights as the built-in administrator may be added to this group. See below, "The built-in administrator".

You cannot delete these groups.

Some iTX services create groups when they are installed. For instance, the OPUS2 Service creates a group called OPUS Administrators (and assigns a security attribute to it). By adding users to these groups, you can give them special rights for working with the services.

## Security attributes

Security attributes determine the rights of users to perform certain actions. To give a user particular rights, you may assign any of these attributes to the user account:

Attribute	Rights
Desktop Administrator	The ability to create and edit iTX Desktop layouts, and make them available to any user or workstation.
Desktop Author	The ability for any particular user to build and edit that user's own layouts, and change what layouts appear in the user view.
Manual Logon	The ability to log onto certain iTX services and Desktop components with different user rights to those of the user that is logged onto the machine. See later in this section, "About Manual Logon".
Security Replication	The ability to copy security data (used by the security system) across domains in a multi-domain system.
Impersonation	Allows impersonation of another user.
Service Manager	The ability to use the Server Manager to remotely start and stop services in the local domain.
Service Administrator	The same rights given by the Service Manager attribute. Also, the ability to remotely change settings for any service running under a Server Controller in the local domain.
Search Publisher	Allows a user to publish saved searches.
Job Type Management	Indicates that a user, group, application or computer may create job types.
Opus Job Administrator	Indicates that a user, group, application or computer has full control over all job instances.
Dashboard Author	Indicates that a user can author SmartClient dashboards.
System Manager	Grants user the right to access various System Management features.
Metadata Management	Indicates that a user, group, application or computer has permission to perform administration of the business metadata configuration.

Attribute	Rights
Asset Lock	Indicates that a user, group, application or computer has permission to lock an asset or media location.
Asset Unlock	Indicates that a user, group, application or computer has permission to unlock an asset or media location.
Administrator	Enables Administrative rights
Ignore Security	Ignores Privilege checks
Ignore Permissions	Ignores Permission checks

### Configuring the security system

A tool for configuring the security system is installed with the System Service. Called the Security Tool, it has a window with tabs, under which it displays tables of security-system information:

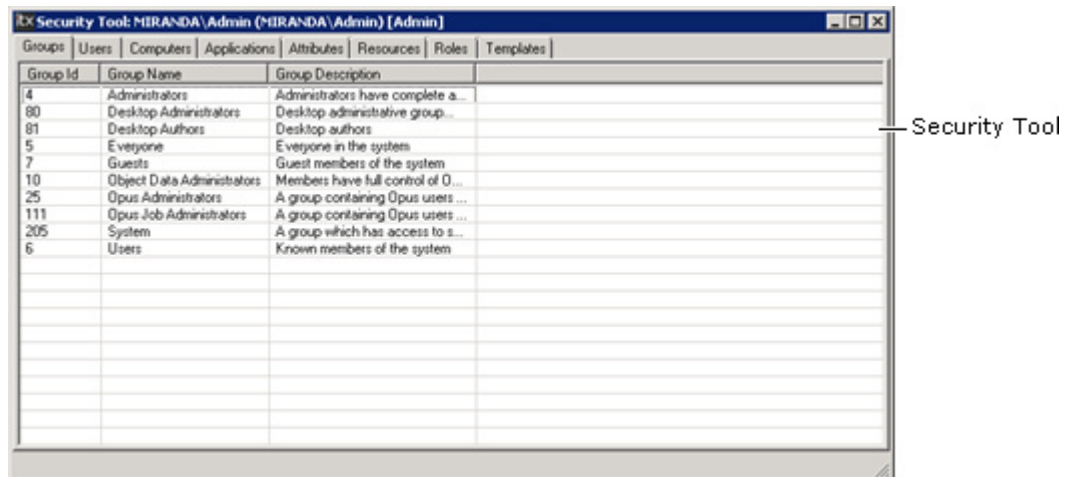

The basic steps for configuring the security system are:

1. Open the Security Tool and manually log onto it as the built-in administrator (or any member of the Administrators group).
2. Create user accounts.
3. Create groups and add users to them.
4. Assign security attributes to your system-administrator account and to groups.
5. Close the Security Tool.

The Security Tool simplifies the task of registering users and groups by enabling you to import the details from a Windows NT network.

There is no need to manually register workstations or applications; this happens automatically.

See later in this section, "About the Security Tool".

## The built-in administrator

For its own configuration, the security system includes a built-in user account that has full administrative rights in the system; this account has the user name "Administrator". You can use it to configure different aspects of the security system.

An entry for the account appears under the Users tab of the Security Tool:



The built-in administrator is a member of the Administrators group. An entry for this appears under the Groups tab:



Any user you add to this group gets the same rights for configuring the security system as the built-in administrator. No other user can change the security-system configuration.

**Note:**

- There are other types of administrator in an iTX system – for instance, an iTX Desktop administrator and a resource-type administrator. The built-in administrator for the security system does not necessarily have the rights that these have for different parts of the wider iTX system. Where you want the built-in administrator to be able to perform other administrator roles, you should use the Security Tool to add the necessary rights to the built-in administrator account.

## About Manual Logon

Any user with the Manual Logon security attribute can log onto certain iTX services and Desktop components with their own user rights.

The attribute is particularly useful when it is necessary to temporarily override restrictions that apply to an operator who is logged onto an iTX Desktop; for instance, to allow a supervisor to perform an action that the operator does not have the right to perform.

By default, only the built-in administrator has the Manual Logon attribute.

You may use the Security Tool to assign the attribute to other users. When you do this, you should set passwords in the security system for these users. Not doing so weakens the security system: it makes it possible for anyone who knows or can successfully guess a user name to change the configuration without having to enter a password. [More details](#), page 72.

Users should carefully manage their passwords; they may change them if they want to.

## About the Security Tool

Through the Security Tool, you configure different aspects of the security system that the tool is connected to. By default, it connects to the security system managed by the local System Service. But you can make it connect to the security system in any remote iTX domain that is on the same network.

When you right-click a table (e.g. "Groups"), the Security Tool displays a menu with options for tasks you may want to perform. Later in this section, we describe procedures for some of the more important tasks. Among these are how to:

- Manually log onto the Security Tool. [More details](#), page 68.
- Import user details from a Windows NT system. [More details](#), page 69.
- Create groups. [More details](#), page 69.
- Create user accounts. [More details](#), page 70.
- Manage group membership. [More details](#), page 70.
- Assign individual users, computers and applications to one or more groups. [More details](#), page 71.
- Set security options for users, groups, computers and applications. [More details](#), page 72.

## Logging onto the Security Tool

To make changes to the security system, you first need to log onto the Security Tool with administrator rights. The first time you do this, you can only do so by using the Manual Logon attribute of the built-in administrator.

The built-in administrator account is created with no password; you log onto the Security Tool with a blank password entry. To prevent unauthorised use of this account, you should set a password for it the first time you log onto the Security Tool.

Once you add yourself to the security system as a user, you can give yourself the same user rights as the built-in administrator by adding yourself to the Administrators group. You may then modify the security-system configuration after logging onto the Security Tool with your own account.

**Important:** To ensure the effectiveness of the security system, administrator rights should only be given to users who have to perform system-administrator tasks.

## The Security Tool menus

When you right-click a table under a tab, the Security Tool displays a menu. The menu options depend on what aspect of the security system is associated with the selected tab. For instance, under the Groups tab, you can create a group:



The range of options depends on where in the table you click. If you click a blank line, the Security Tool displays a short menu with general options; some of these options are present for all tabs. If you click an entry in a table, a long menu appears with extra options for performing actions on that entry.

The next illustrations show the short and long forms of the Groups menu.

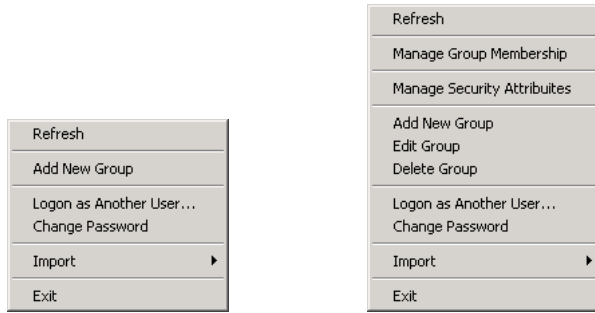

Short menu

Long menu

If you log onto the Security Tool without administrator rights, the menu options are modified: you can view settings, but not change them.

In the following tables, we describe all the menu options; these are available when the Security Tool is in administrator mode.

**Common options (on all menus):**

Option	Action
Refresh	Reload the information for the current table.
Logon as Another User ...	Open the Logon dialog. You can then manually log onto the Security Tool as a different user (e.g. the built-in administrator).
Change Password	Open the Set Password dialog. You can then change the manual log-on password for the user that is currently logged onto the Security Tool.  You need to know the current password before you can change it. If you do not know it, you may set a new password through the Set User Password option in the Users menu.
Import Users Groups Computers	Open the Import Users, Import Groups or Import Computers dialog. Through these, you can copy details of users, groups and computers to the security system from the Windows NT system; also, you can copy details of users and computers that are held in the security system of another System Service.
Exit	Close the Security Tool.

**Options on the Groups menu:**

Option	Action
Manage Group Membership	Opens the Manage Group Members dialog for the selected group. You can then choose what members are to belong to the group.

Option	Action
Manage Security Attributes	Opens the Manage Security Attributes dialog for the selected group. You can then assign security attributes to the group.
Add New Group	Opens the Add Group dialog. You can then create a group in the security system; you enter a group name and description in the dialog, or copy the details from the Windows NT system.
Edit Group	Opens the Edit Group dialog for the selected group. You can then change the description for the group.
Delete Group	Deletes the selected group from the security system. The Security Tool performs the deletion when you confirm that you want it to do so.

**Options on the Users menu:**

Option	Action
Manage Group Membership	Opens the Manage Groups dialog for the selected user. You can then choose what groups the user is to belong to.
Manage Security Attributes	Opens the Manage Security Attributes dialog for the selected user. You can then assign security attributes to the user.
Add New User	Opens the New User dialog. You can then create a user account in the security system; you enter the user details in the dialog, or copy them from the Windows NT system.
Edit User	Opens the Edit User dialog for the selected user. You can then change the display name and description for the user.
Delete User	Deletes the selected user from the security system. The Security Tool performs the deletion when you confirm that you want it to do so.
Set User Password	Opens the Set Password dialog for the selected user. You can then change the manual log-on password for the user; you do not need to know the user's existing password.
Disable User Account (Enable User Account)	Disables (or enables) the selected user account.  Use this if you want to temporarily remove the rights from a registered user without deleting the user account.  A user whose user account is disabled may log onto the iTX system through the guest account.

**Options on the Computers menu:**

Option	Action
--------	--------



Option	Action
Manage Group Membership	Opens the Manage Groups dialog for the selected computer. You can then choose what groups the computer is to belong to.
Manage Security Attributes	Opens the Manage Security Attributes dialog for the selected computer. You can then assign security attributes to the computer.
Edit Computer	Opens the Edit Computer dialog for the selected computer. You can then change the display name and description for the computer.
Delete Computer	Deletes the selected computer from the security system. The Security Tool performs the deletion when you confirm that you want it to do so.

### Options on the Applications menu:

Option	Action
Manage Group Membership	Opens the Manage Groups dialog for the selected application. You can then choose what groups the application is to belong to.
Manage Security Attributes	Opens the Manage Security Attributes dialog for the selected application. You can then assign security attributes to the application.
Edit Application	Opens the Edit Application dialog for the selected application. You can then change the description for the application.
Delete Application	Deletes the selected application from the security system. The Security Tool performs the deletion when you confirm that you want it to do so.  <b>Note:</b> This action does not uninstall the application from the host machine.

### Options on the Attributes menu:

Option	Action
Add New Attribute	Opens the Add Attribute dialog. You can then create an attribute in the security system; you enter the attribute name and description in the dialog.  <b>Note:</b> The attribute only becomes useful when it is defined in the iTX software.
Edit Attribute	Opens the Edit Attribute dialog for the selected attribute. You can then change the description for the attribute.

Option	Action
Delete Attribute	Deletes the selected attribute from the security system. The Security Tool performs the deletion when you confirm that you want it to do so.

**Options on the Resources menu:**

Option	Action
Edit Resource	<p>Opens the Edit Resource dialog.</p> <p>You may specify groups that have administrator rights for resources of the selected type.</p> <p>The option <b>Default Permission Set for 'Everyone' group has 'Full Control'</b> affects the permission set that is attached to new resources. It is used by other Grass Valley applications; it is not used by iTX. By default, the option is not selected for any type of resource; you should not change this setting.</p>

## Using the Security Tool

To change the configuration of the security system, you need to log onto the Security Tool as the built-in administrator or a user in the Administrators security group.

### Open the Security Tool

The Database Server installer creates a shortcut for the Security Tool in the Programs category of the Windows Start menu.

1. Select **iTX Security Tool** from the Windows Start menu.

The Security Tool opens, under the user account you are logged onto the Database Server machine with.

The title bar shows the account details. If you log on as a user who has administrator rights, "[Admin]" appears after the username:



If the user account does not have administrator rights, you need to manually log onto the Security Tool with an account that does.

### Manually log onto the Security Tool with administrator rights

You can manually log onto the Security Tool with any account that has the Manual Logon security attribute. [More details](#), page 72.

1. Right-click the table under any tab of the Security Tool; select **Logon as Another User** from the displayed menu.

The Logon dialog appears.

2. Do the following to enter the new log-on details.
  - In the **User ID** box, enter "administrator". Or enter the domain name, a backslash and then the user name (domainname\username) of the user you want to log on as.
  - In the **Password** box, enter the manual log-on password for the specified user. When you log onto the Security Tool as the built-in administrator for the first time, the user account does not have a password set for it in the security system. So, until you set one, you should leave the **Password** box blank.
  - In the **Domain** box, select the domain in which the security system you want the Security Tool to connect to is active. Usually, you work in the local domain and so leave this unchanged.
  - Click **OK**.

The Security Tool connects to the security system using the specified user account.

## Import users, groups or computers

The easiest way to register a large number of users, groups or computers when you are installing a new iTX system is to import them from the existing Windows NT system. You can use the same procedure to import these details from a security system in another iTX domain.

1. Right-click the table under any tab and select **Import** followed by **Users, Groups or Computers** from the displayed menu.

The Import Users, Import Groups or Import Computers dialog appears.

2. In the dialog, do the following.
  - Select either **Import from an NT Domain** or **Import from a Security Service**.
  - In the **Domain** box, select a domain.
  - Click **Fetch Users, Fetch Groups or Fetch Computers**.

The security system reads information from the selected domain and displays a list of users, groups or computers in the dialog.

- In the displayed list, select the check boxes of the users, groups or computers you want the Service to import.
- Click **Import Selected Users, Import Selected Groups or Import Selected Computers**.

The security system imports the selected details.

3. Click **Close** to close the dialog.
4. Check the imported details in the Security Tool.

## Add a group

Use this procedure to add groups one at a time:

5. Select the Groups tab.
6. Right-click the table under the tab, and select **Add New Group** from the displayed menu.

The Add Group dialog appears.

7. Do one of the following to enter the group details.
  - Enter a name in the **Group Name** box and, if you want to, a description in the **Description** box.
  - Click **Select NT Group** to open the Select NT Group dialog; select an iTX domain; select a group from the displayed list of groups in that domain; click **OK** to close the dialog.
8. Click **OK** to close the Add Group dialog.

An entry for the new group appears in the Groups table.

## Add a user

Use this procedure to add users one at a time:

1. Select the Users tab.
2. Right-click the table under the tab, and select **Add New User** from the displayed menu.

The New User dialog appears.

3. Do one of the following to enter the user details.
  - Enter the domain name, a backslash and then the user name (domainname\username) in the **User ID** box; enter a name and description, if you want to, in the **Name** and **Description** boxes.
  - Click **Select NT User** to open the Select NT User dialog; select an iTX domain; select a user from the displayed list of users in that domain; click **OK** to close the dialog.
4. Click **OK** to close the New User dialog.

An entry for the new user appears in the Users table:

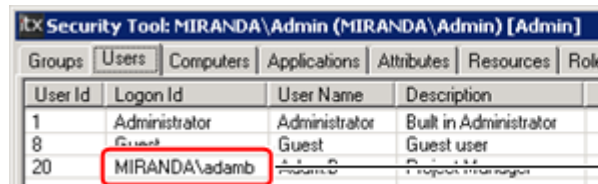

User Id	Logon Id	User Name	Description
1	Administrator	Administrator	Built in Administrator
8	Guest	Guest	Guest user
20	MIRANDA\adamb		

The Logon ID for a user account must include the domain name

## Modify the membership of a group

In this procedure, you select a group and then modify its contents by adding or removing members:

1. Select the Groups tab.
2. Right-click an entry in the table under the tab, and select **Manage Group Membership** from the displayed menu.

The Manage Group Members dialog opens. This displays a list of the group members and a list of available group members.

3. By selecting items in either list and using the buttons (**Add**, **Remove**, **Remove All**), set the contents of the Group Members list.
4. Click **Close** to save your changes and close the dialog.

## **Assign a user, computer or application to one or more groups**

In the following procedure, you select a user, computer or application; you then specify the groups that you want the selection to belong to.

1. Select the Users, Computers, or Applications tab.

2. Right-click an entry in the table under the selected tab. Select **Manage Group Membership** from the displayed menu.

The Manage Groups dialog opens. This displays a list of the groups to which the selected item belongs and a list of available groups.

3. By selecting groups in either list and using the buttons (**Add, Remove, Remove All**), set the contents of the Group Membership list.
4. Click **Close** to save your changes and close the dialog.

## Set security options for a group, user, computer or application

1. Select the Groups, Users, Computers, or Applications tab.
2. Right-click an entry in the table under the selected tab. Select **Manage Security Attributes** from the displayed menu.

The Manage Security Attributes dialog opens. This displays a list of the attributes assigned to the selected item and a list of available attributes.

3. By selecting attributes in either list and using the buttons (**Add, Remove, Remove All**), ensure the Attributes list contains just the attributes you want to assign to the item.
4. Click **Close** to save your changes and close the dialog.

## Set a manual log-on password

If you assign the Manual Logon security attribute to a user account, you should set a password for the account.

1. Select the Users tab.
2. Right-click the entry for the user whose manual log-on password you want to set; select **Set User Password** from the displayed menu.

The Set Password dialog appears, with the name of the selected user in the **UserID** box. The **Current Password** box is greyed out, as you do not need to enter the current password.

3. Enter the new password in the **New Password** and **Confirm Password** boxes. Click **Set** to set the password and close the dialog.

### Note:

- The password you set in this procedure is for the manual log-on process only; it is not required when the account is used to log onto the iTX Desktop.
- If a user enters a wrong manual log-on password 3 successive times, the security system disables the user account. You can enable the user account again, by selecting **Enable User Account** from the Users menu.

## Configuring a Media Watcher

All iTX systems include a Media Watcher. This usually runs on an iTX Media Store (if that machine allows it to).

More complex systems may have more than one Media Watcher. For example, if you keep the media files for different groups of channels on different Media Stores, you may allocate a separate Media Watcher to each Media Store.

For each Media Watcher, the configuration includes details of the paths of an Inbox folder and a Media folder on the iTX Media Store. The Media Watcher monitors the Inbox folder for files being added to the iTX system. It moves the files to the Media folder after registering them:



In some systems, you may install the Media Watcher on an iTX machine that is not an iTX Media Store. For instance, when using a NAS (network-attached storage) system to hold the media files, you may run the Media Watcher on the Database Server machine. You should then place the Inbox and Media folders inside the same, shared folder on the iTX Media Store; this ensures the Media Watcher transfers files between the Inbox and the Media folder most efficiently.

You specify the Inbox and Media folder paths when configuring a Media Watcher after installing it. Through other configuration settings, you may:

- Specify additional iTX Media Stores for media storage and playout.
- Set properties for iTX Media Stores, including a high-water mark for disk-space usage.
- Specify external file stores so that the Media Watcher has access to their media files. In doing this, you may set up the Media Watcher to copy required files to the Inbox, to register them in the iTX system before moving them to the Media folder. External file stores may be folders on external storage devices; or file stores in other iTX domains. The Media Watcher does not manage external file stores.
- Adjust the rate at which the Media Watcher copies files from an external file store to an iTX Media Store.
- Specify a limit (high-water mark) for disk-space usage by the Inbox; the Media Watcher stops copying files to the Inbox from external file stores when the limit is reached.
- Start or stop the Media Watcher monitoring the Inbox (and processing any files that appear in it).
- Set a registration delay, to prevent the Media Watcher registering files too early. You may need to do this to ensure the Media Watcher only registers any file copied from an FTP server when the complete file is in the Inbox.
- Request the Media Watcher to automatically create, on the iTX Media Store, browse copies of new video clips after they are registered. A browse copy is a low bit-rate Windows Media 9 file.
- Request the Media Watcher to automatically create, on the iTX Media Store, keyframes from new video clips after they are registered.

- Select templates for the Media Watcher to use when registering media files. Templates define default values for various properties of SD and HD video clips.
- Specify paths to mirror folders, for the storage of back-up copies of media files that are placed in the Inbox. The Media Watcher does not manage mirror folders.

You make these settings under the Setup tab of the Media Watcher user interface; see below, “The Setup tab”.

You cannot configure a Media Watcher as a back-up service. You can, though, configure a spare Media Watcher and have it on "cold standby" (i.e. ready to take on the tasks of a Media Watcher that fails) but not active until it is required.

## The Setup tab

You configure a Media Watcher, while it is running, by using the features under the Setup tab of its user interface:

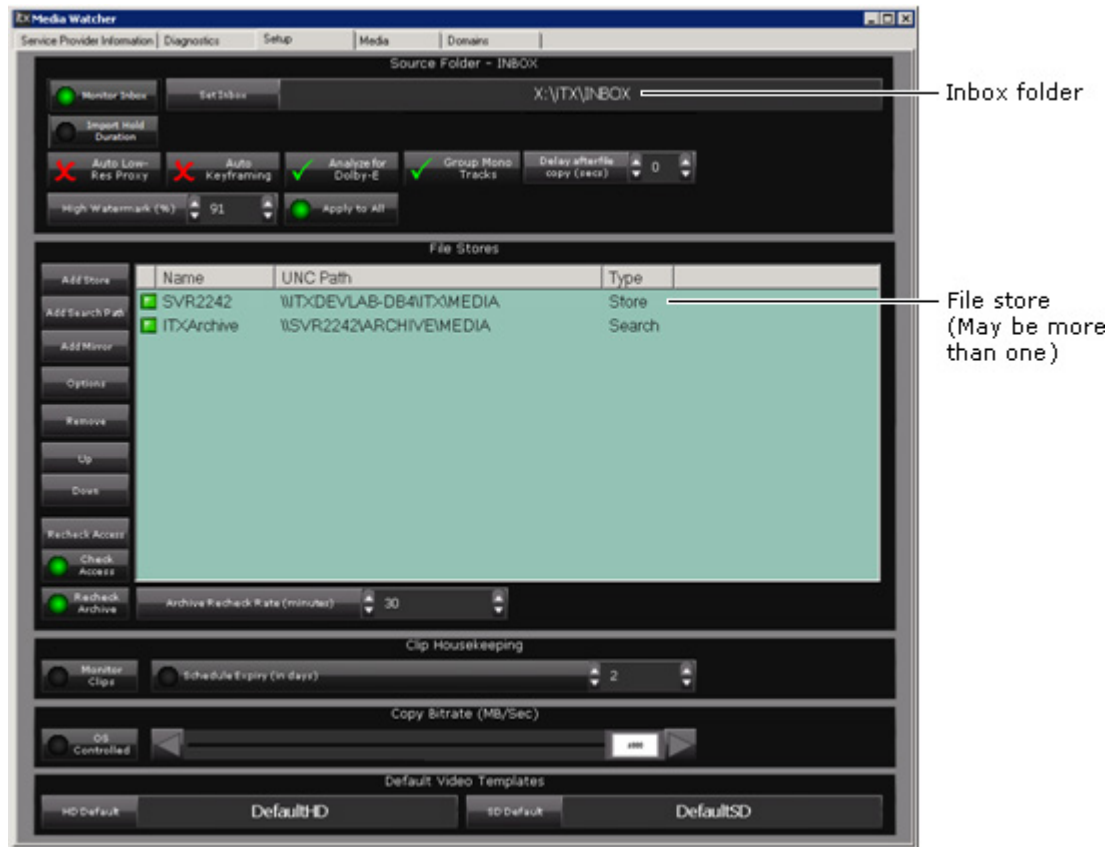

Under this tab, the Media Watcher shows the name of the specified Inbox folder.

It also displays a File Stores list, containing the details of all file stores it has access to. It can store media files in these file stores and/or get files for playout from them. The first file store contains the Media folder to which the Media Watcher moves files from the Inbox.

You can modify the File Stores list by adding file stores, removing file stores or changing their order.

When searching for a media file, the Media Watcher starts with the first file store in the list and works through the others (but not mirror folders) in order, until it finds the file.



## File-store types

File stores for playout are usually one of two types:

- **Store.** This describes a folder, on a Windows-based machine, to which the Media Watcher can move media files that are placed in the Inbox; the files are then available to iTX for playout. A file store of this type is, by definition, an iTX Media Store.
- **Search.** This type of file store may be one of the following: a folder, containing media files that iTX can use, on a machine that is not an iTX Media Store; a set of file stores in another iTX domain; an archive in a Colossus automation system.

A file store of either of these types is identified by a file-store name, which is mapped to the specified folder, remote domain or clip database.

For resilience, it is possible to use a third type of file store:

- **Mirror.** This describes a folder to which the Media Watcher adds back-up media files; these are copies of the media files it moves from the Inbox to a media folder on an iTX Media Store. iTX does not manage mirror folders; nor does it include them as locations in assets in the System Database; the files on them are not available to iTX for playout.

File stores of the mirror type are identified by the UNC path of the specified folder.

For each file store, you should set the sharing permissions of the associated folder to Full Control for all users.

## Inbox settings

You specify an Inbox folder and set properties for it in the Source Folder - Inbox panel:

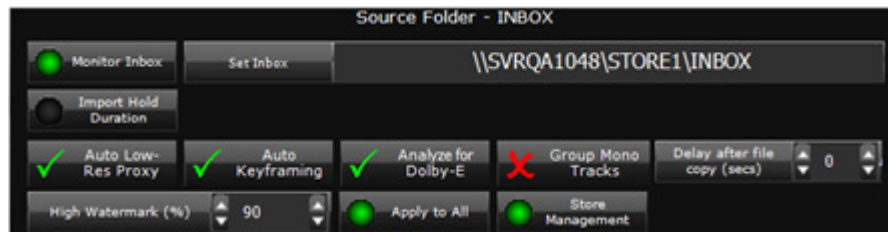

### Specify an Inbox folder

1. Click **Set Inbox**.  
The Media Watcher displays the Select Inbox Folder dialog.
2. Do one of the following to select an Inbox folder.
  - Enter the folder-path details in the **UNC Path** box.
  - Click **Browse** to open the Browse For Folder dialog; select the Inbox folder and click **OK** to close the dialog.
3. Click **OK** to close the Select Inbox Folder dialog.  
The **Set Inbox** box shows the folder-path.

## Monitor the Inbox folder

The Media Watcher must monitor the Inbox folder if it is to register new media files and make them available for use in the iTX system.

1. Ensure **Monitor Inbox** is selected.

## Hold event durations for .osc imports

If you are importing .osc schedules with `tc_dur` values for the clip duration (Hold Duration), Media Watcher can import these values and use this to hold the duration of the event.

1. Select **Hold Import Duration**.

## Create browse copies of video clips

If there is a Proxy Generation Service in your system, the Media Watcher can use this to create a low bit-rate, browse copy for a video clip when it registers the clip.

2. Select **Auto Low-Res Proxy**.

## Create keyframes from video clips

If there is a Keyframe Generation Service in your system, the Media Watcher can use this to create keyframes for a video clip when it registers the clip.

1. Select **Auto Keyframing**.

## Check mono tracks for Dolby E data

In media files placed in the Inbox, audio content in Dolby E format is normally carried in a single track containing a pair of stereo channels. The Media Watcher identifies the channels as a stereo pair that are to play out together.

Dolby E content in some files may appear on two separate tracks, each containing a mono channel. This separation of content prevents the Media Watcher automatically identifying the tracks as a pair for playback.

The Media Watcher can detect two separate Dolby E tracks, though, if they are the first two tracks in a file. It does this by sampling the content of these tracks; if it detects Dolby E data, it marks the tracks as the component parts of a Dolby E stereo pair.

1. Select **Analyze for Dolby E** if you want the Media Watcher to check the first two tracks of all video files for Dolby E data.

## Group mono tracks

Track grouping is a way of linking two mono tracks so that iTX can use them to produce a PCM stereo or Dolby E output signal. You can set up the Media Watcher to automatically perform this process.

1. Select **Group Mono Tracks** if you want the Media Watcher to group pairs of adjacent mono tracks for all video clips.

**Note:**

- An operator can manually group mono tracks on the Asset layout.

**Extended Audio language tagging for grouping mono tracks**

In iTX2, audio tracks using language tags now have the option to use an extra fourth character to describe its channel designation, in order to be grouped automatically, when the clip is registered via Media Watcher.

For example: "ENGL" and "ENGR" may now be recognized as corresponding left and right mono channels of the same language track "ENG" and therefore automatically grouped together (e.g. group 0) upon registration.

The fourth character is treated as a 'wildcard' by Media Watcher and is therefore not restricted to L, or R but can be any single character - only the first three characters need to match.

This is automatically made active by enabling the settings option "Group mono tracks" in the Media Watcher's Setup tab.

Once active, clips tagged in this way will show the same Group ID in the "Location" tab of the Asset Layout when loaded for preview:

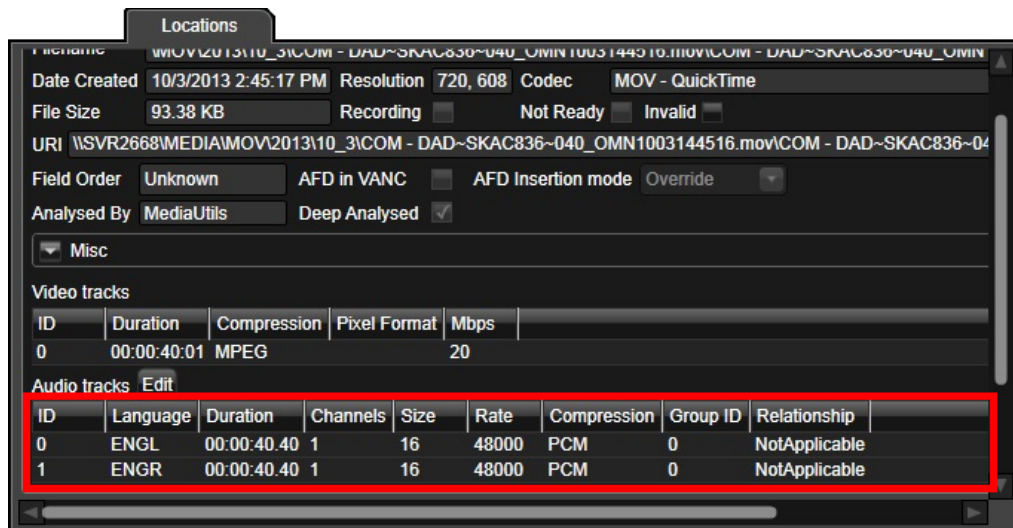

With "Group mono tracks" disabled, clips with mono pairs regardless of the number of characters used will retain a unique group ID.

**Set a delay for media-file registration**

Normally, the Media Watcher registers a media file immediately after checking that the file is in a valid format and copying the file property information to the System Database. Once registered, the media file becomes available to use in the iTX system.

When a media file is being copied to the Inbox from an FTP server ([more details](#), page 86), the Media Watcher may need to introduce a delay – to ensure the file copying is complete – before it registers the file.

During the delay, the Media Watcher repeatedly checks the modification time of the file. Each time this property changes, the Media Watcher restarts the delay. When the property stays the same for the duration of the delay, the Media Watcher registers the media file.

In most iTX systems, the registration delay is set to zero. It is only necessary to set a delay for copying processes during which the media file is not locked (e.g. FTP transfer).

1. To set a registration delay, enter the value for the length of the delay (in seconds) in the **Delay after file copy** box.

### Set the high-water mark for the Inbox folder

The Media Watcher stops copying media files to the Inbox folder from external file stores when the amount of disk space used by the Inbox folder reaches the high-water mark. This is a setting that controls the amount of disk space allocated to the Inbox-folder; it is given as a percentage of the total available space on the drive that contains the Inbox.

1. Enter a percentage value in the **High Water Mark (%)** box to set the disk-space limit for the Inbox.

### Apply the Inbox high-water mark to Media folders on iTX Media Stores

When you set a high-water mark for the Inbox folder, you can apply the same value to Media folders that iTX manages; i.e. ones on iTX Media Stores that appear in the File Stores list.

1. Select **Apply to All** if you want Media folders on iTX Media Stores to use no more disk space than the percentage level that you set for the Inbox folder.

In the Store Location Options dialog for each iTX Media Store, the Media Watcher overwrites the high-water mark with the Inbox value. See below, "Adding a file store of the store type to the File Stores list".

## Adding a file store of the store type to the File Stores list

The first time the Media Watcher starts, the File Stores list is blank. You need to add at least one file store of the store type, i.e. an iTX Media Store. This must map to a folder called "Media" on the iTX Media Store.

To add the file store, you use the Store Location Options dialog:



Through this dialog, you create a file store and give it a simple name; the name appears in the **File Store** box. You enter details of the folder path in the **Path** box.

You can specify a high-water mark for the file store – a limit to the total amount of space that media files in the mapped folder can take up. The Media Watcher stops adding media files to the file store when the used space reaches the high-water mark.

You can add other file stores of the store type to the File Stores list, and let the Media Watcher choose which one to use for storing registered media files – it chooses the one with the most available free space. The name of the mapped folder for each additional file store must start with "Media" (e.g. "Media For Today").

At any time, you may remove a file store from the File Stores list. iTX continues to hold the details of the file store. If you want to re-add it to the list later, you can select it in the **File Store** box.

## Add a file store of the store type to the File Stores list

1. Click **Add Store** under the Media Watcher Setup tab.

The Media Watcher displays the Store Location Options dialog.

2. Do the following to create a file store.

- Click **New** to display the Enter File Store Name dialog.
- Enter a name in the **Name** box; click **OK** to close the dialog.

iTX creates a file store with the specified name. The Store Location Options dialog shows the name in the **File Store** box and "Invalid UNC Accessor" (meaning there is no mapped folder) in the **Path** box.

3. Click **Edit** to display the Select Media Folder dialog.
4. Do one of the following to select a shared folder to map the file store to.
  - Enter the folder-path details in the **UNC Path** box.
  - Click **Browse** to open the Browse For Folder dialog; select a folder and click **OK** to close the dialog.
5. Click **OK** to close the Select Media Folder dialog.
6. If you do not want the Media Watcher to search the store folder for missing media files that iTX is due to play out in a schedule, select **Disable Searches on this Volume**.
7. To set the high-water mark, enter a percentage value in the **High Water Mark (%)** box.

**Note:** This entry is replaced by the corresponding Inbox-folder value if you select **Apply to All** in the Source Folder - Inbox panel.

8. Click **OK** to close the Store Location Options dialog.

The Media Watcher adds the file store to the File Stores list.

## Modify the options for a file store of the store type

1. Select a file store in the File Stores list.
2. Click **Options**.

The Media Watcher displays the Store Location Options dialog.
3. Edit any of the options in the way you want to.
4. Click **OK** to close the Store Location Options dialog.

## Adding a file store of the search type to the File Stores list

A file store of the search type – or external file store – may be any of the following.

- A shared folder on an external machine; i.e. a machine that is not an iTX Media Store. The machine may be an IT store, a video server or a video archive.
- The set of file stores in the Files Stores list of any remote iTX domain.
- An archive in a Colossus automation system.

To add such a file store, you use the Store Location Options dialog:



Through this dialog, you create a file store and give it a name; the name appears in the **File Store** box. You select a Media Watcher plug-in in the **Plugin** box and configure settings for this plug-in.

Where the file store is a shared folder on an external machine, you usually configure iTX to copy required files from the store to an iTX Media Store; from there, a Media Cache Service can cache them to an Output Server. In some circumstances, you may configure iTX to play out files from the file store directly. To allow it to do this, the files need to be registered. [More details](#), page 232.

When working with assets in a remote iTX domain, iTX copies the assets and their associated media files to the local domain.

To use video clips from a Colossus system, iTX creates its own assets from the clips and copies the associated media files to an iTX Media Store.

### Media Watcher plug-ins for external file stores

With the standard external-search License, Media Watcher can work with shared network folders and folders on Omneon servers.

Separate Media Watcher plug-ins (each requires its own License) enable a Media Watcher to use a range of types of external file store. We describe the plug-ins in the following table.

Plug-in	Description
(None)	<p><i>For basic search-folder functionality</i></p> <p>The Media Watcher can use these types of folder as file stores:</p> <ul style="list-style-type: none"> <li>– A shared folder on a Windows-based IT store; you need to specify the UNC path to the folder.</li> <li>– A media folder on an Omneon video server or MediaGrid.</li> </ul> <p><a href="#">More details</a>, page 84.</p> <p>When a reference MOV or MXF file on an Omneon video server is copied to an iTX Media Store, the Media Watcher registers the reference file. If it can read timecode information from the file header, it adds this information to</p>

Plug-in	Description
	<p>the iTX asset. The video and audio (essence) files are stored in a subfolder of the reference file folder.</p>
<p>Core</p>	<p><i>For access to a Colossus system database</i></p> <p>iTX can copy clip information from a Colossus system database.</p> <p>When an event in a live schedule features an asset that is not registered in the iTX system, the Media Watcher searches the Colossus database for a matching clip; the clip must be associated with a media file in an archive location (specified in the plug-in configuration).</p> <p>On finding the clip, it creates a corresponding asset in the iTX System Database and copies the clip information from the Colossus database. The iTX asset includes a useclip flag – a property setting that causes iTX, when playing out the clip, to use the in- and out-points copied from the clip in the Colossus system.</p> <p>Once the iTX asset is created from the Colossus clip, the Media Watcher manages the copying of the required media file from the archive to an iTX Media Store. For this, it requires the DIVArchive plug-in.</p>

Plug-in	Description
<p>DIVArchive</p>	<p><i>For access to a Front Porch Digital DIVArchive</i></p> <p>You can configure the Media Watcher to use a DIVArchive as an external file store in three types of archive operation:</p> <ul style="list-style-type: none"> <li>– The restoring of a media file from a DIVArchive.</li> <li>– The archiving of a media file to a DIVArchive.</li> <li>– The deleting of a media file from a DIVArchive.</li> </ul> <p><a href="#">More details</a>, page 85.</p> <p><b>Restoring</b></p> <p>When a schedule event features a media file that is not on an iTX Media Store but is on a DIVArchive, iTX can restore the media file; i.e. copy it from the archive to an iTX Media Store.</p> <p>For an operation of this type, the Media Watcher requests the DIVArchive to copy the media file to the Inbox folder. Once the file is there, the Media Watcher registers it and moves it to an iTX Media Store.</p> <p>If the restored media file is later deleted from the iTX system, iTX may keep its asset (with details of the archive location) in the System Database. This makes it easier for iTX to restore the media file the next time it is needed.</p> <p>Manual and Schedule based Restore Jobs are issued with a HIGH priority (75/100)</p> <p><b>Archiving</b></p> <p>iTX can archive a media file to the DIVArchive when the Media Watcher registers the file from the Inbox. In general, it can archive files of the types identified by the filename extensions listed below.</p> <p><b>Video</b> .avi; .gxf; .mov; .mpg; .mpeg; .mxf; .saf; .ts; .wmv; .xlt</p> <p><b>Audio</b> .mp3; .wav; .wma</p> <p><b>Still image</b> .bmp; .jpeg; .jpg; .png; .spg; .tif; .tiff</p> <p><b>iTX CG</b> .cap</p> <p>In the archiving process, the DIVArchive copies a media file from its Media Store location; the original media file is not deleted.</p> <p>Archiving jobs are issued with a MEDIUM priority (50/100)</p> <p><b>Deleting</b></p> <p>iTX can delete a media file from the DIVArchive when its asset is deleted (for example, on the Asset layout).</p>
<p>External Domain</p>	<p><i>For access to one or more remote iTX domains</i></p> <p>iTX can copy assets and media files from other iTX domains.</p> <p>When an event in a live schedule features an asset that is not in the local</p>



Plug-in	Description
	<p>iTX system, the Media Watcher searches specified remote domains for a matching asset. On finding the asset, it creates a copy of it in the iTX System Database in the local domain.</p> <p>Once the asset is created, the Media Watcher manages the copying of the required media file to an iTX Media Store in the local domain.</p>
FTP	<p><i>For access to an FTP server</i></p> <p>iTX can use a media folder on an FTP server as a search folder. The FTP server must be able to handle either Unix or Microsoft IIS commands. <a href="#">More details</a>, page 86.</p>
Suitcase	<p><i>For access to a Suitcase TV archive</i></p> <p>iTX can use a media folder on a Suitcase TV video server as a search folder. <a href="#">More details</a>, page 87.</p>

You select a plug-in when you set up an external file store in the Search Location Options dialog.

### About iTX timestamps on media files copied from external file stores

When registering a media file, iTX adds the term "\_OMN" and a timestamp to the file name when it places the file in the Media folder on an iTX Media Store. So, for example, *MyFile.mpg* may become *MyFile\_OMN1123164831.mpg*. The iTX asset references the renamed file.

You can configure a Media Watcher to search an external folder for files with or without the timestamp. If the external folder is on an iTX Media Store in another system, the required file may have the iTX timestamp; if it is on any other type of storage device, the required file is unlikely to have the iTX timestamp.

To allow the Media Watcher to search most efficiently, you should only request it to search for iTX-timestamped files when it is necessary to do so.

### Add a file store of the search type to the File Stores list

1. Click **Add Search Path** under the Media Watcher Setup tab.

The Media Watcher displays the Search Location Options dialog.

2. Do the following to create a file store.

- Click **New** to display the Enter File Store Name dialog.
- Enter a name in the **Name** box; click **OK** to close the dialog.

iTX creates a file store with the specified name; the name appears in the **File Store** box.

3. Select a plug-in in the **Plugin** box.
4. Set options for the plug-in (see one of the following procedures).
5. Click **OK** to close the Search Location Options dialog.

The Media Watcher adds the file store to the File Stores list.

**Note:**

- You can view or modify file-store options by selecting a file store in the File Stores list and clicking **Options**.

## Set file-store options for an external IT store or Omneon video server

After adding a file store for an external IT store or Omneon video server, you do the following to configure it in the Search Location Options dialog.

1. Select "None" in the **Plugin** box.
2. Do the following to select a search folder.
  - Click  to open the Select Share dialog.
  - Enter the folder-path details in the **UNC Path** box.  
Or, click **Browse** to open the Browse For Folder dialog; select a folder and click **OK** to close the dialog.
  - Click **OK** to close the Select Share dialog.
3. Select **Copy media to central store** if you want the Media Watcher to copy media files from the external file store to an iTX Media Store.
4. If you want the Media Watcher to search for iTX-timestamped media files, select **Search for Omnibus '\_OMN' files**.  
You should select this option only when it is needed (e.g. to search a folder on an iTX Media Store in a different system). [More details](#), page 83.
5. Click **OK** to close the Search Location Options dialog.

## Set file-store options for a Colossus system database

The Core plug-in enables a Media Watcher to copy clip information and archived media files from a Colossus system.

To enable iTX to use a Colossus clip, the Media Watcher has to copy the clip information from the Colossus database into an iTX asset. It must do this before it restores the associated media file. To ensure this happens, you need to make the Colossus database the highest file store of the *search* type (after all file stores of the *store* type) in the File Stores list.

To be able copy the associated media files, the Media Watcher requires an archive plug-in (e.g. the DIVArchive one).

After adding a file store for a Colossus system, you do the following to configure it in the Search Location Options dialog.

1. Select the Core plug-in in the **Plugin** box.
2. Do the following to enter a sample folder path for the plug-in.
  - Click  to display the Select Share dialog.
  - In the **UNC Path** box, enter path details of a sample folder, such as "\\Core\Plugin"; the path must include the double-slash and the single slash; you may type any text after the slashes (it does not have to correspond to an existing folder).
  - Click **OK** to close the dialog.

The plug-in may not work without the sample path.

3. Ensure **Search for Omnibus '\_OMN' files** is not selected.
4. Enter the details the Media Watcher needs to access to the Colossus database:
  - In the **Server** box, enter the name of the Microsoft SQL Server that runs the Colossus database.
  - In the **Database Name** box, enter the name of the Colossus database.
  - Select **Trusted Authentication**. Or enter the required database-access credentials in the **Username** and **Password** box.
5. Leave the entry in the **Shared Procedure** box unchanged.

This identifies a special program the Media Watcher uses to get information from the Colossus database.

6. In the **Locations** box, enter details of any archive or FTP locations that video clips you want to work with should include. You may specify multiple locations, separated by commas.  
  
For the Media Watcher to identify a matching Colossus clip, the clip must have the specified location details. The Media Watcher includes the same location details in the iTX asset it creates.
7. Click **OK** to close the Search Location Options dialog.

**Note:**

- You need to include an archive search folder after the Core search folder.

## Set file-store options for a Front Porch Digital DIVArchive

After adding a file store for a Front Porch Digital DIVArchive, you do the following to configure it in the Search Location Options dialog.

1. Select the DIVArchive plug-in the **Plugin** box.
2. Ensure **Search for Omnibus '\_OMN' files** is not selected.
3. Enter the IP address of the DIVArchive in the **Diva IP Address** box.
4. Enter the port number for the DIVArchive in the **Diva Port** box.
5. In the **Simultaneous Jobs** box, enter the maximum number of media files the Media Watcher is to handle at one time.
6. In the **Restore Host** box, enter the host name of the server to which the Media Watcher should send requests to copy media from the DIVArchive. This host name must be the same as the one set in the DIVArchive configuration settings.
7. In the **Archive Transfer Type** box, select the type of transfer the Media Watcher should use to copy media from the DIVArchive.
8. In the **Category** box, enter the name of the category iTX is to use for archiving and restoring media files. The name must match the name set in the DIVArchive configuration settings.

You may enter up to 5 categories, separated by commas, for iTX to search when restoring files; it searches the categories in order until it finds a required media file. iTX uses only the first category in the list for archiving.

9. If you want iTX to delete a media file from the DIVArchive when its media item is deleted on the Asset layout, select **Delete from Archive**.

- If you want iTX to archive a media file to the DIVArchive when the Media Watcher registers the file, select **Archive on Ingest**.

Do one of the following.

- Select **Overwrite Archive** if you want iTX to overwrite any previously archived copy of the media file.
  - Ensure **Overwrite Archive** is not selected if you do not want iTX to overwrite any previously archived copy of the media file.
- If iTX is to archive media files to the DIVArchive, enter the group name for the archived media in the **Default Media Name** box. The name must match the name set in the DIVArchive configuration settings.
  - Click any of the following buttons to open PinPoint. Then set search criteria to create a list of media files, of a particular type, that iTX is to be able to archive.
    - **Set Video Archive Filter**, for video clips.
    - **Set Audio Archive Filter**, for audio clips.
    - **Set Graphics Archive Filter**, for still images (e.g. logos).
    - **Set CG Archive Filter**, for CGs.

Set search criteria for each type you want iTX to be able to handle: iTX only archives items that appear in PinPoint search results.

- Click **OK** to close the Search Location Options dialog.



## Set file-store options for remote iTX domains

After adding a file store for one or more remote iTX domains, you do the following to configure it in the Search Location Options dialog.

- Select the external-domain plug-in the **Plugin** box.

The Media Watcher displays a search-domains panel with two panes: Available Domains and Selected Domains. Each domain you define in the Locator Service Configuration tool appears in one of the panes. [More details](#), page 49.

- Ensure only the remote domains you want iTX to be able to search in appear in the Selected Domains pane.

- To move a domain from one pane to the other, select it and click  or .
- To re-position a domain in the Selected Domains list, select it and click **Move Up** or **Move Down**.

The order of domains in the Selected Domains pane defines the search order: iTX searches the one at the top of the list first.

- In the **Simultaneous Jobs** box, enter the maximum number of media files the Media Watcher is to handle at one time.
- Click **OK** to close the Search Location Options dialog.

## Set file-store options for an FTP server

After adding a file store for an FTP server, you do the following to configure it in the Search Location Options dialog.

1. Select the FTP server plug-in in the **Plugin** box.
2. Select **Copy media to central store** if you want the Media Watcher to copy media files from the external file store to an iTX Media Store.
3. If you want the Media Watcher to search for iTX-timestamped media files, select **Search for Omnibus '\_OMN' files**.  
You should only select this option when it is needed (e.g. to search a folder on an iTX Media Store in a different system). [More details](#), page 83.
4. In the **Max Jobs** box, enter the maximum number of media files the Media Watcher is to handle at one time.
5. Enter the IP address of the FTP server in the **IP Address** box.
6. Enter the path details of the search folder in the **Path** box.
7. Enter the port number for the FTP server in the **Port** box.
8. Enter the required access credentials in the **Username** and **Password** boxes.
9. Select the type of FTP server in the **Type** box.
10. If your FTP server has an FTP proxy running on the firewall software, select the **Enable Proxy FTP** check box.  
If your FTP server does not have an FTP proxy, clear this check box.
11. Click **OK** to close the Search Location Options dialog.

## Set file-store options for a Suitcase TV archive

After adding a file store for a Suitcase TV archive, you do the following to configure it in the Search Location Options dialog.

1. Select the Suitcase TV plug-in in the **Plugin** box.
2. Enter the path details of the search folder in the **Path** box.
3. If you want the Media Watcher to search for iTX-timestamped media files, select **Search for Omnibus '\_OMN' files**.  
You should only select this option when it is needed (e.g. to search a folder on an iTX Media Store in a different system). [More details](#), page 83.
4. Enter the IP address of the Suitcase TV archive in the **IP Address** box.
5. Enter the port number for the Suitcase TV archive in the **Port** box.
6. In the **Inbox Alias** box, enter the inbox configuration set for the Suitcase TV archive.
7. In the **Simultaneous Jobs** box, enter the maximum number of media files the Media Watcher is to handle at one time.
8. Click **OK** to close the Search Location Options dialog.

## Adding file stores of the Mirror type to the File Stores list

Mirror stores may be used to hold media files in a back-up system. [More details](#), page 92.

## Add a file store of the mirror type to the File Stores list

1. Click **Add Mirror**.  
The Media Watcher displays the Select Media Folder dialog.
2. Do one of the following to select a folder on a mirror file store.
  - Enter the folder-path details in the **UNC Path** box.
  - Click **Browse** to open the Browse For Folder dialog; select a folder and click **OK** to close the dialog.
3. Click **OK** to close the Select Media Folder dialog.  
The Media Watcher adds the mirror file store to the File Stores list.

## Modifying the File Stores list

You may want to remove a file store from the File Stores list to stop the Media Watcher accessing it.

When searching for media files, the Media Watcher searches file stores in the order in which they appear in the File Stores list. You may change the positions of file stores to change the search order.

### Remove a file store from the File Stores list

1. Select a file store in the File Stores list.
2. Click **Remove**.

### Re-order file stores

1. Select a file store in the File Stores list.
2. Click **Up** or **Down**.

## Managing file stores

### Check the Media Watcher can access a file store

1. Do the following to check that the Media Watcher can access any particular file store.
  - Select a file store in the File Stores list.
  - Click **Recheck Access**. An "Accessible" entry in the right column indicates the Media Watcher can access the folder.

**Note:** It may take up to 30 seconds for the Media Watcher to establish a connection to a location. Because of this, you should wait for that amount of time, after adding a file store to the list, before you click **Recheck Access**.

## Set up automatic access checking for file stores

The Media Watcher, TXPlay and the Encode Server can check their access to file stores at regular intervals.

1. Do one of the following to set up or cancel automatic access checking.
  - If you want the Media Watcher, TXPlay and the Encode Server to check access to file stores, select **Check Access**.
  - If you do not want these services to do this, ensure **Check Access** is not selected.

### Note:

- **Check Access** should be selected for most iTX systems.
- This setting affects all Media Watchers in your iTX system – changing the setting for any Media Watcher changes it for all.
- When **Check Access** is not selected, the Media Watcher, TXPlay and the Encode Server perform an access check when you run the diagnostics. If you re-enable access checking, you must run the diagnostics for these services.
- The first time you cancel access checking, you must restart the Media Watcher, TXPlay and the Encode Server.

## Set up the Media Watcher to recheck external file stores when searching for media files

When an event requires a media file that is not registered in the iTX system, the Media Watcher may search for the file on an archive or any other type of external file store. You can set it up to keep checking the external file stores at regular intervals.

1. Select **Recheck Archive** if you want the Media Watcher to keep checking external file stores when it cannot find a required unregistered media file.
2. Enter a value in the **Archive Request Rate** for the length of the interval (in minutes) between each check.

### Note:

- These settings affect all Media Watchers in your iTX system – changing the settings for any Media Watcher changes them for all.

## Set up the Media Watcher to delete old schedules

The Media Watcher can delete old schedules from the System Database and so prevent them appearing in PinPoint search results.

1. Select **Monitor Clips**.
2. Select **Schedule Expiry (in days)**.
3. In the **Schedule Expiry (in days)** box, enter the number of days the Media Watcher should leave a schedule in the System Database for before deleting it.

**Note:** The expiry time is based on the creation date of a schedule. So, for a value of 5, the Media Watcher deletes schedules 5 days after the date on which they are created.

## File-copying speed

A Media Watcher manages the copying of files from external file stores to an iTX Media Store when they are required for playout. You can configure the copying speed to happen at the fastest speed that the operating system can handle, or at a slower speed. You may need to reduce the speed to prevent copying operations interfering with various Media Watcher tasks.

### Change the file-copying speed

You can reduce the speed at which files are copied to a Media Store from a search folder. You may need to do this to prevent the process interfering with various Media Watcher tasks.

1. Do one of the following to set the file-copying speed.
  - Select **OS Controlled**, if you want the copying to happen as fast as the operating system allows it to.
  - To set a specific speed, clear the **OS Controlled** selection; move the **Copy Bitrate** slider to select the highest file-copying speed that does not have an adverse effect on Media Watcher operations.

## Selecting default clip templates for media files imported through the Inbox

When the Media Watcher registers a video file placed in the Inbox, it checks the display resolution of the file. Depending on this, the Media Watcher uses either the SD default clip template or the HD default clip template to create the asset for the file.

A clip template stores settings for a group of media-item properties; for example, the aspect-ratio of a video clip. You can modify the settings for the SD and HD templates in the Asset layout.

### Note:

- The Media Watcher may use clip templates other than the default ones when registering files placed in sub-folders. It can do this if there are clip templates with names that match the sub-folder names. [More details](#), page 227.

### Select the default clip template for HD video clips

1. Click **HD Default** to open PinPoint.
2. Use PinPoint to select the clip template you want to use as the HD default.  
The name of the clip template appears in the HD Default box.

### Select the default clip template for SD video clips

1. Click **SD Default** to open PinPoint.
2. Use PinPoint to select the clip template you want to use as the SD default.  
The name of the clip template appears in the SD Default box.



## Searching for files requested by a Media Cache Service

The Media Watcher may receive requests from a Media Cache Service to copy media files from search folders to an Output Server cache or an iTX Media Store. The Media Watcher searches for these files in the search folders of the File Stores list.

## Setting up search domains under the Domains tab

In a multi-domain system, TXPlay for any channel may use the OPUS 2 Service to find assets that are not in the local domain but are in other domains. [More details](#), page 253.

The Media Watcher enables you to configure a central domain search list for all channels. The list specifies the domains that TXPlay for each channel has access to and the order in which the OPUS 2 Service is to search them.

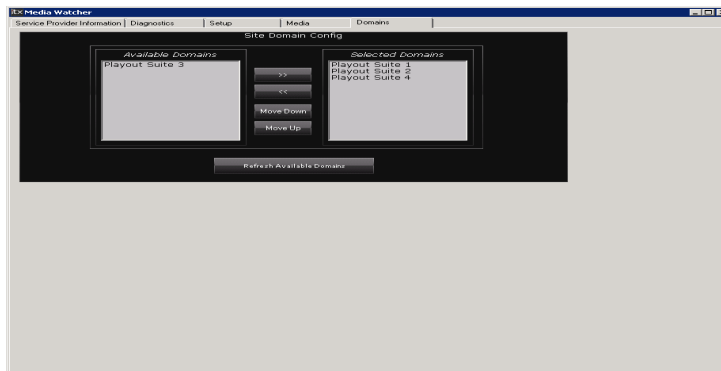

You create the central domain search list by using the features in the Site Domain Config panel under the Domains tab of the Media Watcher user interface:



The panel has two panes: Available Domains and Selected Domains. Each domain you define in the Locator Service Configuration tool appears in one of the panes. [More details](#), page 49.

You create the domain search list in the Selected Domains pane.

### Create a central domain search list

1. Do the following if you want to add a domain to the domain search list.
  - Select the domain in the Available Domains pane.
  - Click .
2. Do the following if you want to remove a domain from the domain search list.
  - Select the domain in the Selected Domains pane.
  - Click .
3. Do the following if you want to re-order the domain search list.
  - Select a domain in the Selected Domains pane.
  - Click **Move Down** or **Move Up**.

In general, the local domain should appear first in the list.

**Note:**

- If there is more than one Media Watcher in the local domain, you can create or modify the central domain search list in any of them: each Media Watcher displays the list under its Domains tab.
- If the central configuration is not suitable for any particular channel, you may set up the channel to use its own domain search list rather than the central one. You need to create identical local domain search lists for playout and cache channels on the Channel Configuration pop-up layout.

## Configuring a Media Watcher to copy media files to an independent back-up system

For back-up purposes, you may have a second complete iTX system running in parallel with the main one. In this case you can use the Media Watcher in the main system to copy media files to the back-up system, after it registers them in the main system.

There are then two options for selecting the mirror folders. Which one you select depends on how the system enters the media-file records in the back-up System Database.

- If there is no automatic synchronisation of the main and back-up System Databases, you should specify the Inbox folder in the back-up system as the mirror file store. Then, the Media Watcher in the back-up system registers the media files and moves them to a Media folder.
- If you use the SQL Server replication feature to synchronise the back-up System Database with the main one, you should specify a Media folder (not the Inbox folder) in the back-up system as the mirror file store. Then the Media Watcher in the back-up system does not register the copied media files.

**Note:**

- The Media Watcher does not run as a back-up service – in a parallel back-up system, it runs as a primary service.

## Configuring the Time Service

iTX calculates all playout times on the basis that the Time Service delivers time in the international standard, UTC. You need to configure the Time Service to ensure it meets this requirement. You should do this by using the Time Service Configuration tool:

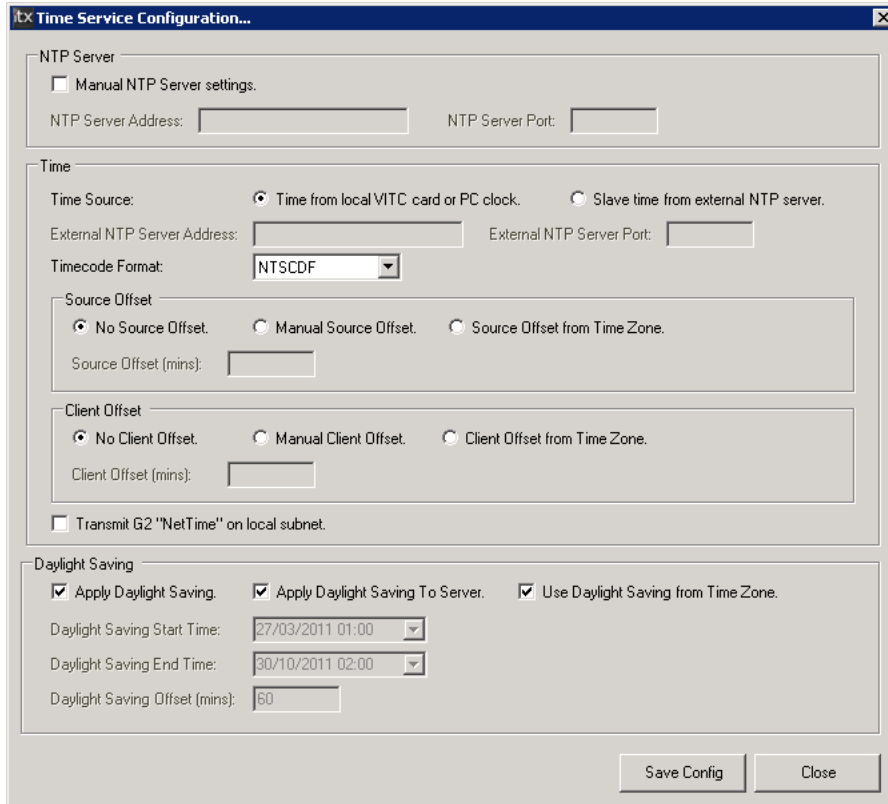

In configuring the Time Service, you specify the location of the time source. You also specify whether or not the time source has any offset from UTC (either for a timezone difference or for daylight saving); this enables the Time Service to convert the input, if necessary, to ensure its output is in UTC.

The iTX services that require a time source have an in-built component called a time-service client; the iTX Desktop also has this component. A client receives the UTC time from the Time Service and passes it to its service or iTX Desktop. The client can adjust the time, for a timezone or daylight saving, before it does this. Any adjustment is set in the Time Service configuration.

Because the iTX playout service TXPlay has its own configuration options for a timezone offset and daylight-saving boundaries, we recommend you do not make such adjustments in the Time Service. Instead, you should configure them for each playout channel on the Channel Configuration pop-up layout. See "UTC Offset", page 139, and "Daylight Saving Time Boundaries", page 139.

### Display the Time Service Configuration tool

1. Select **Time Service Config** from the iTX 2.0 programs category in the Windows Start menu.

## Configure the Time Service

1. Select one of the following to identify the time source.
  - **Time from local VITC card or PC clock.**
  - **Slave time from external NTP server.**
2. Select the system timebase in the **Timecode Format** box.

This must be the same as the VITC timebase if a VITC source is used.
3. If the time source is an external NTP server, enter the details:
  - The IP address of the server in the **External NTP Server Address** box.
  - The port on which the Time Service is to communicate with the server in the **External NTP Server Port** box.
4. Do one of the following, to enable the Time Service to make any necessary adjustment to the time source.
  - Select **No Source Offset** if the time source is supplying time in UTC.
  - Select **Manual Source Offset** if the time source has an offset from UTC that you want to manually specify. Enter the number of minutes for the offset in the **Source Offset (mins)** box.
  - Select **Source Offset from Time Zone** if the time source has an offset from UTC that the Time Service should detect from the time-zone setting of the machine supplying the source.
5. Ensure **No Client Offset** is selected.
6. Ensure **Apply Daylight Saving** is not selected.
7. Click **Save Config**.

### Note:

- If the machine on which the Time Service is running has more than one network card, you need to specify the IP address of the one connected to the NTP Server Panel and the communications port for the connection. The NTP Server panel of the Time Service Configuration tool allows you to do this.
- The G2 “Net Time” setting is not used by iTX.

## Starting iTX Desktops

Once the system services are running, you may start the iTX Desktops on the various workstations.

When you start the iTX Desktop for the first time on any workstation, the workstation becomes registered in the iTX system; you can then assign a layout view to the workstation.

After you register an operator with the security system, you can assign a layout view to the operator. The operator then has access to that view in the iTX Desktop.

[More details](#), page 100.

### Start an iTX Desktop

- Do one of the following to start an iTX Desktop.
  - Double-click an iTX Desktop shortcut on your Windows desktop.
  - Select the iTX Desktop option from the Windows Start menu.

The iTX Desktop opens.

### About the iTX Desktop

The iTX Desktop is the user interface that enables operators, system administrators and engineers to interact with iTX system services. It has three main parts:

- At the top is the title bar.
- In the middle is the selected layout.
- At the bottom is the layout selection bar.

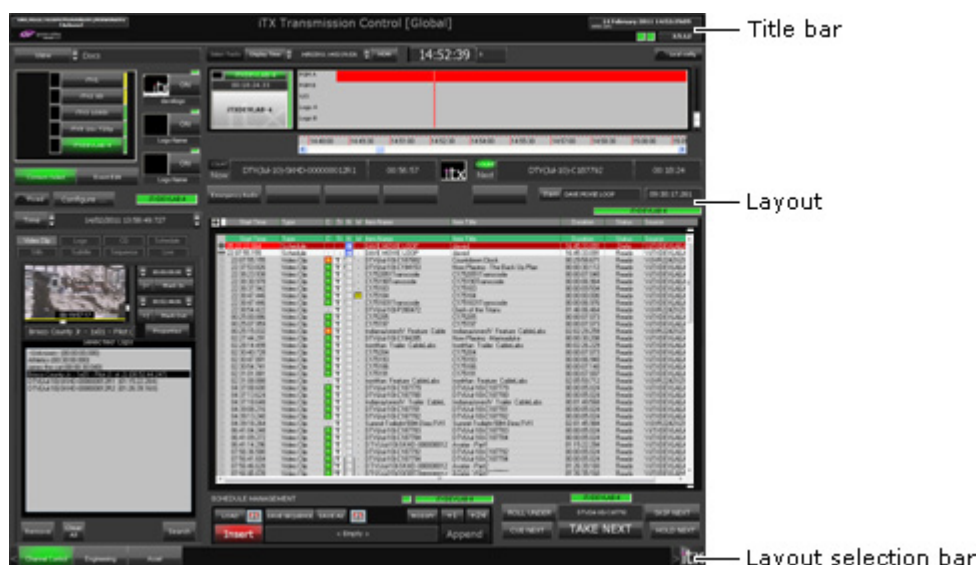

The title bar has these features:

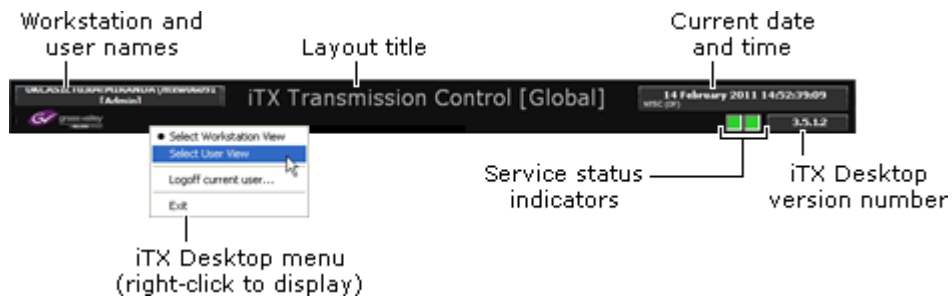

The layout selection bar has these features:

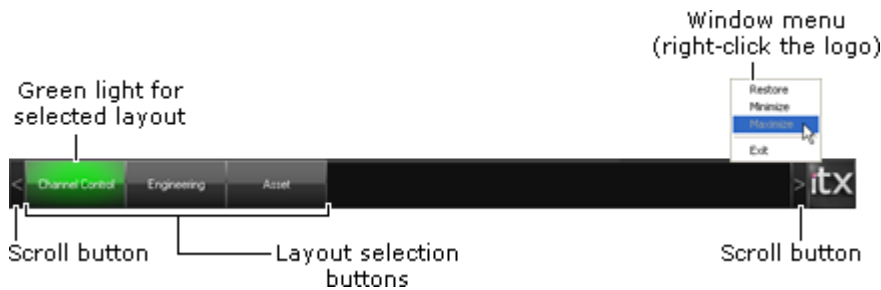

By clicking the layout selection buttons, you can select different layouts. From the iTX logo, on the right, you can access the window menu; through this, you can maximise, minimise, restore and exit the iTX Desktop.

The set of layouts represented by buttons in the layout selection bar is known as a layout view. At any iTX Desktop workstation, two types of layout view are available: a workstation view and a user view. [More details](#), page 100.

The iTX Desktop opens in the workstation view. If the workstation view does not have any layouts, the iTX Desktop opens in the user view instead (provided this view has layouts).

### About the iTX Desktop at a system-administrator workstation

Before starting the iTX Desktop at a system-administrator workstation, you should ensure your system-administrator account has the user rights of Desktop Administrator and Desktop Author.

When you start the iTX Desktop for the first time, neither the workstation view nor the user view has any layouts. The iTX Desktop opens in the workstation view and displays a blank layout.

Before you can add layouts to either view, you need to switch the iTX Desktop to your user view. In this layout view, you can put layouts in the layout-editing mode and edit them. You cannot edit layouts in the workstation view.

In either your user view or the workstation view, you can assign channel views to workstations, and layout views to workstations and users.

## About the iTX Desktop at an operator workstation

When an operator starts the iTX Desktop at an operator workstation, the operator has access to the layouts you assign to the workstation view and the operator's user view. Until you assign layouts, both views are blank.

How much control operators have in modifying iTX Desktops depends on their user rights. In general, they should not be able to edit layouts or change the layout view of any user. To ensure this, the Desktop Administrator security attribute should not be assigned to operators.

The iTX Desktop displays a notice in front of any layout feature that is unavailable for security reasons. One such feature is the Desktop View Manager on the Layout Management pop-up layout:

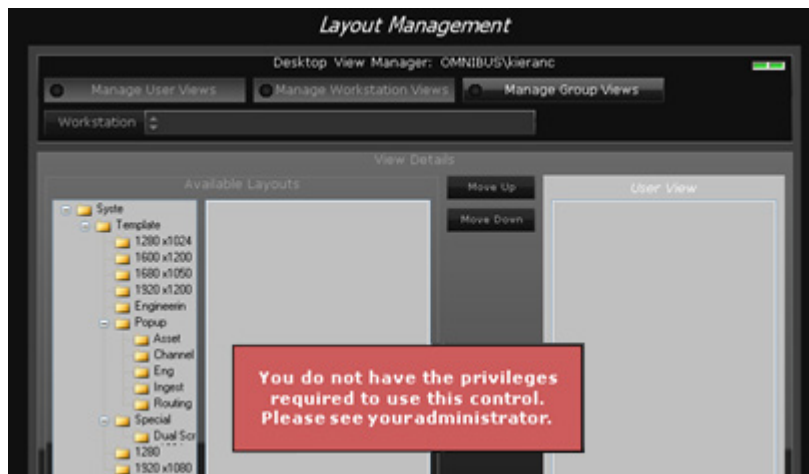

## Checking the connection of iTX Desktops to the system services

1. At each iTX Desktop workstation, check the service-status indicators in the title bar display a green light:

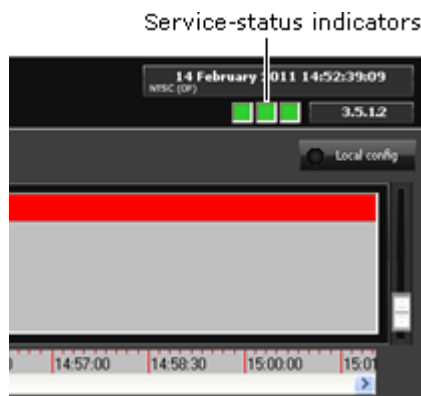

The green lights show the iTX Desktop is connected to key Database Server services and that the services are running normally. In a system with a Locator Service, the indicators represent, from left to right: the Locator Service, the System Service, and the Logging Service.





The Locator Service indicator does not appear if the system is operating without a Locator Service.

Service-status indicators on the Engineering layout provide similar information for the services on the Output and Database Servers. [More details](#), page 263.

## About service status indicators

The indicators in the iTX Desktop title bar show the operational status of key Database Server services. Similar indicators feature in many of the components on iTX Desktop layouts; these indicators relate to the system services that the components use.

Each indicator displays a coloured light that shows the status of its associated service. The colours have these meanings:

Indicator	Status
 (green)	Normal. The service is operating normally.
 (yellow)	Warning. A current system event or condition may prevent the service operating normally; the service continues to run.
 (red)	Failure. The service has failed.
 (black)	Off. The service is not running.

Resting the mouse pointer over an indicator causes a tool tip to appear. The tool tip gives the name and IP address of the service:

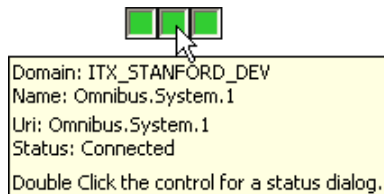

If you want more detailed information about a service, double-click an indicator to display the Service Provider Status dialog for that service:



If you click **Run Self Diagnostic** on this dialog, the service performs a simple diagnostics test; it then displays the test details and results in a report dialog.



**NOTE:** Obtaining detailed information by double clicking an indicator light is not possible for BACKUP, only Master channels.

# Setting up views for workstations and operators

To enable operators to do their tasks, you need to give them the iTX Desktop features they are to use for those tasks. To do so, you:

- Create a layout view for each workstation. You may also create layout views for individual operators.
- Create channel views and assign them to workstations. The channel views are available to all operators at the workstation.

You do this at your system-administrator workstation.

## Layout views

By "layout view", we mean the set of iTX Desktop layouts that are available to the operator who is logged onto an iTX Desktop workstation. The operator can select any of these layouts by clicking a layout selection button.

At any time, an iTX Desktop displays one of two layout views:

- The **workstation view** is the layout view you assign to the workstation.
- The **user view** is the personal layout view of the operator logged onto the workstation.

You may create a different workstation view for each workstation, depending on the tasks that are to be done at that workstation. The workstation view is available to all operators.

You may give individual operators their own user views, depending on the functionality that they need to do their jobs. Operators have access to their user views at any workstation.

## Selecting the workstation view or user view

You choose which view the iTX Desktop is to display from the iTX Desktop menu. Right-click the title bar (or a clear area of the layout) to display the menu:



The title-bar shows the names of the workstation and logged-on operator; these identify the available views.



## Registering of workstations and operators before the assigning of layout views

Workstations and operators, when they are first registered with the security system of the System Service, have blank layout views.

- The registering of a workstation happens automatically the first time you start the iTX Desktop at that workstation.
- The registering of operators requires the Security Tool. [More details](#), page 68.

Once workstations and operators are registered in the iTX system, you can assign layout views to them. At any time, you may modify a view by adding, removing or re-ordering layouts.

## Layouts available for layout views

During the installation of the Media Watcher, the installer places a set of iTX layouts in the Media Watcher program folder. When the Media Watcher starts, it registers the layouts and stores them in the System Database.

The layouts are registered as global layouts. This means you can include them in layout views at any iTX Desktop workstation, as this illustration shows:

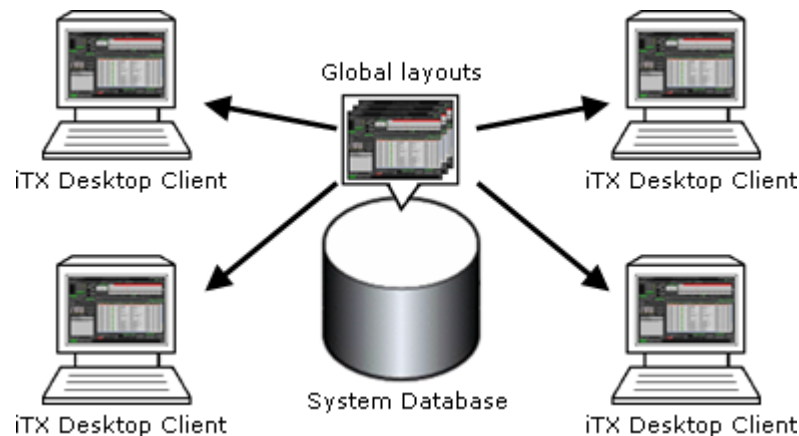

You set up workstation views and user views based on these global layouts.

In the System Database, the layouts are organised in a structure that can be represented by a folder tree:

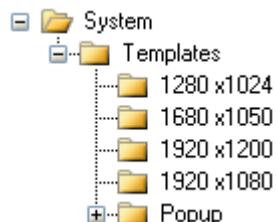

All the global layouts are stored in sub-folders in a Templates folder.

There are multiple copies of the main layouts at different screen resolutions. The names of the folders that contain them indicate the screen resolutions (1280x1024, etc.).

Layouts with the same features have the same name in the different folders; for example, there is a layout called Channel Control in each folder.

As well as the main layouts, there are a number of pop-up layouts – layouts that appear in front of a main layout when they are active. These are in the Popup folder.

When you assign layouts to a view, you select only main layouts. Pop-up layouts, where they are required, are linked to features on the main layouts when the layouts are created.

**Note:**

- Layouts in the Templates folder are overwritten by layouts with the same name when you upgrade the Media Watcher. To keep edited versions of these layouts, you should save them with different names, or in different folders, so that they are not overwritten.

## Standard layouts

In general, there are two types of standard global layout (for different user roles): system-administrator layouts and operator layouts.

We describe the most commonly required layouts in the following tables.

### System-administrator layouts

These layouts are for system configuration and administration:

Layout name	Layout purpose
-------------	----------------

Layout name	Layout purpose
Engineering	<p>Monitoring of the status of key system services; also, monitoring of all system alerts, with controls for responding to them.</p> <p>Includes buttons for pop-up layouts:</p> <ul style="list-style-type: none"> <li>▪ Channel Configuration, for the configuration of channels of all types (playout, cache, etc.).</li> <li>▪ Channel View Management, for the assigning of channel views to workstations.</li> <li>▪ Layout Management, for the management of layout views.</li> <li>▪ Routing Configuration, for the configuration and testing of router crosspoints. This layout is intended for initial configuration and testing of the system only.</li> <li>▪ Opus Administration, for system management tasks involving the OPUS 2 service.</li> <li>▪ Colour Configuration, for designing the Schedule Grid colour scheme.</li> <li>▪ GPI (Configuration and Test), for setting up iTX to work with a GPI device.</li> <li>▪ Name Rule Configuration, for defining rules for the automatic naming of clips.</li> <li>▪ Logging, for the viewing of active logs stored by the Logging Service.</li> <li>▪ Security, for managing security in iTX.</li> </ul>
Job Monitoring	Viewing of full details of all jobs meeting specified search criteria.
Media Transfers	Viewing of details of file-copying processes handled by a Media Cache Service or a Media Watcher.
Router Control (Complex)	<p>A reference layout for the operation and monitoring of iTX-controlled routers.</p> <p>You should configure a custom routing layout for your particular system. <a href="#">More details</a>, page 324.</p>
Routing Playout Example 1	A reference layout for monitoring playout channels; and for operating iTX-controlled routers when a manual channel failover is needed.
Server Manager	Access to Server Controllers on all servers for the monitoring and control of services.

## Operator layouts

These layouts are for day-to-day operation of iTX:

Layout name	Layout purpose
Asset	<p>Preparation of media for schedule playout.</p> <p>The layout has features for searching for assets, previewing them and editing their metadata.</p>
Asset Segmentation	Dividing of long video clips into smaller ones.

Layout name	Layout purpose
Asset View	Previewing of video assets.
Channel Control	Building of online and offline schedules. Full control of schedule playout for any selected channel.
Channel Control Wide	Building of online and offline schedules. Full control of schedule playout for any selected channel. This layout has the same components as the Channel Control layout, but arranged differently and with a wider Schedule Grid.
Channel Edit	Editing of a schedule in a selected playout or edit channel.
Channel Group Control	Viewing of schedule events in multiple channels on a single Timeline Display. Hold, cue and take control of the next event in all live schedules in a selected channel view. Ability to replace any event in all live schedules in a single operation (global edit).
Channel View	Monitoring of a live schedule in a selected playout channel.
Dual Ingest (Select by View)	Manual recording of media from a video line feed, with routes set from within the iTX system. Control of simultaneous independent recordings in up to 2 recording channels within selected channel views.
Gang Control	Viewing of schedule events in multiple channels on a single Timeline Display. Hold, cue and take control of the next event in all live schedules in a selected channel view.
Ingest Multi	Manual recording of media from a video line feed, with no router control from within the iTX system. Control of simultaneous independent recordings in up to 6 recording channels within a selected channel view.
Item Insertion	The control of playout in a selected channel with the ability to insert a news-flash sequence, which can be selected from an edit channel.
Live Channel Bypass	Creating, editing and controlling of schedules in two parallel channels running on the same Output Server machine. You need to set up a live channel before this layout can be used.
Manual Ingest (Select by View)	Manual recording of media from a video line feed, with no router control from within the iTX system. Control of simultaneous independent recordings in up to 3 recording channels within a selected channel view.
Multi-Channel Control	Viewing of schedule events in multiple channels on a single Timeline Display. Limited control of schedule playout for a selected channel.
Multi-Channel Display	Viewing of schedule events in multiple channels on a single Timeline Display. No control of schedule playout.

Layout name	Layout purpose
Multi-Channel Monitor	Monitoring of playout in multiple channels on a single Timeline Display. Control of failover from main to back-up channels.
Preview Channel	Control of the previewing of schedule events on a video monitor before iTX plays them out.
Tape Ingest	Manual or automatic recording of media from a videotape machine connected directly to an Encode Server.
User Jobs	Viewing and managing of jobs by the logged-on user.
In a system that includes Ingest Manager:	
Ingest Manager	Monitoring and control of automated recordings. Includes a button for a pop-up layout: <ul style="list-style-type: none"> <li>▪ Scheduled Bookings, for the configuration and scheduling of automated recordings.</li> </ul>
Ingest Manager (Naming Rule)	Ingest Manager layout with automatic naming feature.

In a typical iTX system, the system-administrator layout view should give access to all the main global layouts for system configuration, operation, monitoring and diagnostics.

Any workstation or user view should contain just the layouts a particular operator needs; e.g. for scheduling (Channel Control and Multi-Channel) or media preparation (Asset and Manual Ingest).

## Using cloned layouts

If you run the iTX installer to upgrade the Media Watcher, the Media Watcher overwrites existing Template layouts with new Template layouts that have the same name. This may result in you losing modifications you make to Template layouts.

For this reason, we recommend you follow this practice when adding Template layouts to a layout view: if you intend to modify a layout, you should only add a copy – or *clone* – of the layout to the view. You give the cloned layout a different name to the name of the original layout, or store it in a different folder

You do this by selecting the clone option and renaming the layout when adding it to your system-administrator user view. After modifying the layout, you should save it as a global layout and add it to any workstation or user layout view that requires it.

If a Template layout contains a pop-up layout that requires modification, you should also create a copy of the pop-up layout.

## Creating a system-administrator layout view

The first time you start the iTX Desktop on your system-administrator workstation, there are no layouts in the workstation and user views; the iTX Desktop appears blank when you select either view. The same is true for all operator workstations.

You need to create a system-administrator user view that gives you full administrative and operational control of your system. With this view, you can assign layout views to workstations and operators.

In the process, you need to modify some layouts to make them suit particular requirements of your system. For system-security reasons, you can only modify layouts in a user view (not a workstation view).

## Manage Views dialog

To add layouts to your blank user view, you use the Manage Views dialog:

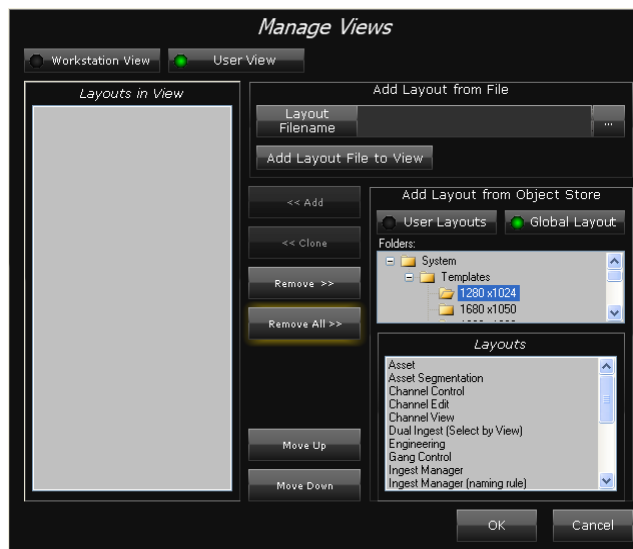

The Manage Views dialog enables you to modify your current workstation and user views. You choose a view to modify through one of the two selection buttons (**Workstation View** and **User View**) at the top of the dialog.

Beneath these buttons, on the left, the Layouts in View pane shows what layouts currently make up the selected view. On the right, the Layouts pane shows what layouts are available for adding to the view. You can move layouts from one list to the other. You can also move layouts up or down the Layouts in View list; this changes their order of appearance on the iTX Desktop.

When you add a layout to a view, you can add the original version of the layout that is in the System Database or you can add a cloned copy of this. You should clone any layout that you intend to modify. By doing so, you can protect it from being overwritten when you upgrade the Media Watcher.

## Add layouts to your system-administrator user view

To start with, you should add all the layouts that are to be used in your system to your user view. After checking them and making any necessary modifications, you may remove the ones you do not require.

1. Do the following to open the Manage Views dialog.
  - On the iTX Desktop, right-click the title bar (or a clear area of the layout) to display the iTX Desktop menu. Select **Select User View**.
  - From the iTX Desktop menu again, select **Manage Views**.



2. Ensure **User View** is selected in the dialog.
3. Select **Global Layouts**.

A Folders pane appears above the Layouts pane; it displays a list of the layout folders in the System Database. The Layouts pane displays a list of layouts at the root level of the selected folder.
4. Select a folder (e.g. 1280x1024) containing main layouts.
5. Do the following for each layout in the folder that you want to use without modifying.
  - Select the layout in the Layouts pane.
  - Click **<<Add**.

The layout appears in the Layouts in View pane (and disappears from the Layouts pane).
6. Do the following for each layout that you want to modify before using.
  - Select the layout in the Layouts pane.
  - Click **<<Clone**.
  - Enter a new name and title for the cloned layout in the Rename Cloned Layout dialog.

The cloned layout appears in the Layouts in View pane (the original stays in the Layouts pane).
7. Do the following if you want to change the position of any layout.
  - Select the layout in the Layouts in View pane.
  - Click **Move Up** or **Move Down**.

For convenience, you may make the Engineering layout the first one in your view; this is the layout you use most for system administration.
8. Click **OK** to close the Manage Views dialog.

The iTX Desktop updates your user view. It displays the first layout in the view and a set of layout selection buttons.

**Note:**

- You can remove a layout from a view by selecting it in the Layouts in View pane and clicking **Remove>>**.

## Assigning layout views from your system-administrator view

From your system-administrator view, you can assign layout views to any workstation or operator. You do this from the Engineering layout:



Clicking **Manage Layouts** displays the Layout Management pop-up layout:



Through the Desktop View Manager on this layout, you can select the layout view of any workstation or user and check its contents:

- With **Manage Workstation Views** selected, the **Workstation** selection box appears. This lets you select any registered workstation.
- With **Manage User Views** selected, the **User** selection box appears. This lets you select any registered operator.

You can modify a selected view by:

- Adding layouts.
- Removing layouts.
- Re-ordering layouts.

The Available Layouts area has two panes: the left one shows the folder tree for layouts in the System Database; the right one displays a list of all layouts in a selected folder.

The Workstation View or User View pane (depending on which type of view you are working with) shows which layouts make up the selected view.

You modify a view by adding layouts to the Workstation View or User View pane, or removing them from there. The order in which layouts appear in this pane determines the order of their selection buttons on the iTX Desktop.

## Display the View Management pop-up layout

1. On the Engineering layout, click **Manage Layouts**.

The View Management pop-up layout appears in front of the Engineering layout.

## Select a workstation layout view

To be able to select a workstation view, you may need to start the iTX Desktop on that workstation.

1. Click **Manage Workstation Views**.
2. Select a workstation in the **Workstation** box.

## Select a user layout view

To be able to select a user view, you may need to register the user with the security system. [More details](#), page 70.

1. Click **Manage User Views**.
2. Select a user in the **User** box.

## Add a layout to a layout view

1. Select a workstation or user layout view in the Desktop View Manager.
2. Select a layout in the Available Layouts list. You may need to navigate through the folder tree to find any particular layout.

You can select multiple layouts by pressing the Shift or Control key while clicking layout names.

3. Click **Add >>**.

The Desktop View Manager adds the selected layouts to the Workstation View or User View pane; the **Save** button flashes.

4. Click **Save** to save the layout view.

**Note:**

- You may update the folder tree or Available Layouts list by clicking **Refresh Folders** or **Refresh Available Layouts**.

**Change the order of layouts in a layout view**

1. Select a workstation or user layout view in the Desktop View Manager.
2. Select a layout in the Workstation View or User View list of the Desktop View Manager.
3. Click **Move Up** or **Move Down**.  
The layout moves up or down the list.
4. Click **Save** to save the layout view.

**Remove a layout from a layout view**

1. Select a workstation or user layout view in the Desktop View Manager.
2. Select a layout in the Workstation View or User View list of the Desktop View Manager.
3. Click << **Remove**.  
The Desktop View Manager removes the layout from the list.
4. Click **Save** to save the layout view.

**Refreshing a layout view**

To display a workstation view after modifying it, you need to restart the iTX Desktop at the workstation.

After you modify the user view of an operator, the operator needs to restart the iTX Desktop at any workstation.

**About channel views**

A channel view is a group of channels of any type – playout, edit, cache or ingest – that are accessible to all operators at a particular workstation. It is a property that you assign to workstations (not to individual users).

Channel-selection components display a selection button for each channel in a selected channel view. An example is the Channel Selector on the Channel Control layout, shown in this illustration:

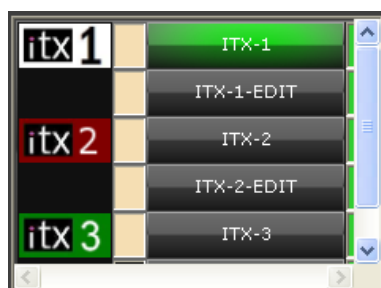

Through the channel selection buttons, an operator selects a single channel to work with.

You can assign more than one channel view to a workstation. An operator then selects one of these views by using the Channel View Selector:



Enabling a workstation to work with a particular channel view is a two-step process: you first create the channel view; you then assign the channel view to the workstation. You perform these tasks on the Channel View Management pop-up layout.

## Channel access levels

When you create a channel view, you specify access levels for each channel in the view. A channel can allow three levels of access:

Access level	Description/comments
View only	An operator can view the events in a schedule that is loaded in the channel, but cannot edit or control the schedule.
Edit	An operator can edit a schedule; for instance, by adding or removing events.
Control	An operator can perform actions to control live playback. An example is the taking of an event to air under manual control.

## Display the Channel View Management pop-up layout

1. On the Engineering layout, click **Manage Views**.

The Channel View Management pop-up layout appears in front of the Engineering layout. It contains two tools, side by side: a View Editor and a Workstation Editor.

## Setting up a channel view

To create or modify a channel view, you use the View Editor on the Channel View Management pop-up layout:



The left pane displays the Available Channels list; the right pane, the Selected Channels list. You can use channel separators to add spaces between buttons on a Channel Selector when that has the channel view assigned to it.

## Create a channel view

1. Click **New View** on the View Editor.  
The Enter View Name dialog appears.
2. In the **Name** box, enter a name for the new channel view; click **OK** to close the dialog.  
The View Editor displays the name in the **View** box.
3. Do the following for each channel (or separator) you want to include in the new channel view.
  - Drag the channel (or separator – the dashed line) from the Available Channels list to the Selected Channels list.
4. Do the following to specify access levels for any channel.
  - Select a channel in the Selected Channels list.
  - Select **Edit (E)** to give operators the right to change schedules; or, ensure the option is not selected if you want to deny operators this right.
  - Select **Control (C)** to give operators the right to manually control schedule events; or, ensure the option is not selected if you want to deny operators this right.

Symbols after the channel name in the Selected Channels list show the access levels for the channel. For example: "iTX-1 (E) (C)" means operators have edit and control access levels for the channel iTX-1.
5. Click **Save** to save the channel view.  
The time and date are updated in the **Modified** box.

### Note:

- You can remove a channel from a channel view by dragging it from the Selected Channels list to the Available Channels list.
- Selecting **List All** causes the View Editor to include all system channels in the Available Channels list. You do not usually use this option when creating and modifying channel views.

## Select a channel view in the View Editor

Selecting a channel view in the View Editor displays the view details. You can then modify the channel view or delete it.

1. Select a channel view in the **View** box.

## Modify a channel view

1. Select the channel view in the View Editor.
2. To modify the channel view by adding or removing channels, select a channel in the Available Channels or Selected Channels list and drag it to the other list.
3. Click **Save** to save the modified channel view.  
The time and date are updated in the **Modified** box.

## Delete a channel view

1. Select a channel view in the View Editor.
2. Click **Delete**.
3. When a dialog appears prompting you to confirm your request, click **OK**.

The View Editor deletes the channel view.

## Assigning a channel view

After creating a channel view in the View Editor, you can assign it to any workstation. For this, you use the Workstation Editor on the Channel View Management pop-up layout:

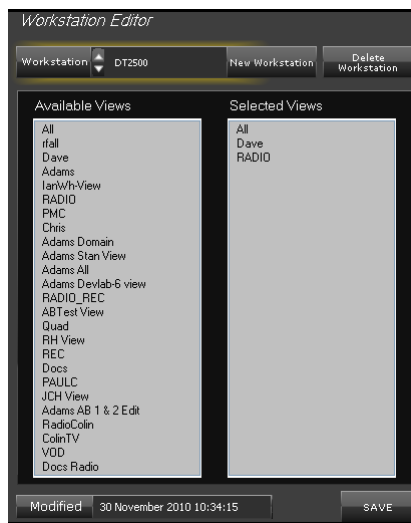

The Workstation Editor holds a list of workstations that are chosen to receive channel views. You can add any workstation that is registered in the iTX system to this list.

## Add a workstation to the Workstation Editor list

Before you can assign a channel view to a workstation, you need to add the workstation to the Workstation Editor list.

1. On the Workstation Editor, click **New Workstation**. The New Workstation dialog appears.
2. Select, or enter the name of, a workstation in the **Name** box; click **OK** to close the dialog.

The Workstation Editor adds the workstation to its list; it displays the name of the workstation in the **Workstation** box.

3. Click **Save** to save the modified Workstation Editor list.

The time and date are updated in the **Modified** box.

## Select a workstation in the Workstation Editor

Before you can modify a channel-view configuration or delete a workstation from the Workstation Editor list, you need to select a workstation in the Workstation Editor.

1. Select a workstation in the **Workstation** box.



## Assign channel views to a workstation

1. Select a workstation in the Workstation Editor.
2. Do the following for each channel view you want to assign to the workstation.
  - Drag the channel view from the Available Views list to the Selected Views list.
3. Do the following if you want to unassign any channel view.
  - Drag the channel view from the Selected Views list to the Available Views list.
4. Click **Save** to save the modified configuration.

The time and date are updated in the **Modified** box.

## Delete a workstation from the Workstation Editor list

1. Select a workstation in the Workstation Editor.
2. Click **Delete**.
3. When a dialog appears prompting you to confirm your request, click **OK**.
4. Click **Save** to delete the workstation permanently from the list.

## Modifying layouts

After installing the different iTX Desktop Client modules on the system-administrator and operator workstations, you may need to modify some iTX Desktop layouts slightly to suit your system design.

The iTX Desktop on your system-administrator workstation allows you to modify layouts while they are in the layout-editing mode. When you save changes to a global layout, they apply wherever you use that layout in the iTX system.

**Note:** To put layouts in the layout-editing mode and edit them, you must be in your user view; you cannot edit layouts in the workstation view.

You can switch some layouts to the layout-editing mode directly from the iTX Desktop menu. These layouts have features that require different settings for different systems. Other layouts, which do not require any structural changes, are locked. To unlock them, and put them into the layout-editing mode, requires the entry of a password.

You may need to make these changes to layouts:

- On the Engineering layout, connect service-monitoring components to iTX services. [More details](#), page 118.
- On the Engineering layout, associate Alert buttons with audio files. [More details](#), page 119.
- On a suitable system-administrator layout, add an Auto Failover Control to enable the system to switch to a back-up machine if an Output Server fails. [More details](#), page 120.
- On various layouts, change group properties. [More details](#), page 121.
- On the Asset layout, configure Asset Type buttons. [More details](#), page 122.
- On the Asset layout, associate search buttons with PinPoint search criteria. [More details](#), page 123.
- On various ingest layouts, set the properties of the Encoder Settings buttons; these properties control what options are available to operators when setting the structure of files created during ingest. [More details](#), page 123.

If you are using iTX in a system with a matrix router, you may need to make these layout changes:

- On various routing layouts, map router control components to the router. [More details](#), page 124.

Your system may include a Channel Control or Multi-Channel layout that is configured to display the next event in a particular channel view on a preview monitor. You may need to make this layout change:

- Configure the hold time for preview events. [More details](#), page 127.

We describe how to make these changes in this section. To prevent modified layouts being overwritten during a system upgrade, you should make the changes on cloned versions of Template layouts. [More details](#), page 105.

You need to make the cloned layouts global, so that they can be included in any other user view or workstation view.

## About the layout-editing mode

When a layout is in the layout-editing mode, you can modify it by moving, resizing, adding, and deleting components; also, by changing component properties.

Because this means that you can significantly change a layout, you should be careful to only change it in the way we describe in this section.

If you change a component accidentally, and are uncertain how to restore it to its original state, you should exit the iTX Desktop without saving your changes. You can then start the configuration again. [More details](#), page 129.

Once you have completed the configuration, you should exit the layout-editing mode to prevent accidental or unauthorised changes to the layout. Before you do, you may lock the layout by specifying a password. Anyone who wants to put the layout into the layout-editing mode must then enter the password.

### Select the layout-editing mode

1. On the iTX Desktop, right-click the title bar (or a clear area of the layout) to display the iTX Desktop menu. Select **Edit**:

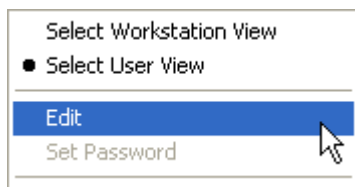

If the layout is not locked, it changes to the layout-editing mode. Red text for the title and a red dot on the layout selection button (when you start to make changes) show the layout is in this mode. A locked layout displays a dialog requesting you to enter a password; entering the password unlocks the layout and puts it into the layout-editing mode.

On the layout, construction lines between linked components may be visible:

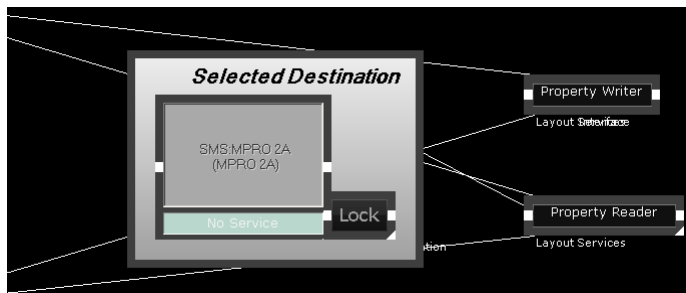

The layout displays the Toolbox:



The Toolbox contains components that you can add to layouts.

In general, since the installed layouts already contain the required components, you do not need to use the Toolbox. There are possible exceptions:

- If there are not enough Channel Monitors on the Engineering layout, you may add some.
  - If your system includes a standby Output Server, you may need to add an Auto Failover Control to a suitable engineering layout.
2. If the Toolbox obscures an area of the layout where you want to work, click any part of its border and drag the Toolbox away.

## Configuring service-monitoring components

Two types of component give information about the operational status, or “health”, of all system services running under a particular Server Controller:

- A Server Monitor displays information about the services running on the Database Server machine.
- A Channel Monitor displays information about the services running on an Output Server machine.

The standard Engineering layout has two Server Monitors, for displaying the health of the services running on two Database Servers (these may be main and back-up machines):



It also has four groups of transmission-chain components. Each contains features that relate to key parts of the system for a playout channel. These include two Channel Monitors, for displaying the health of main and back-up playout channels:

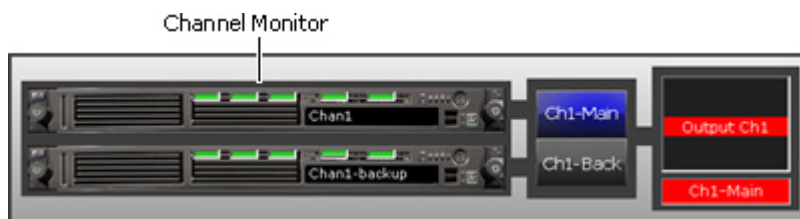

Each group also has router control features for channel failover:

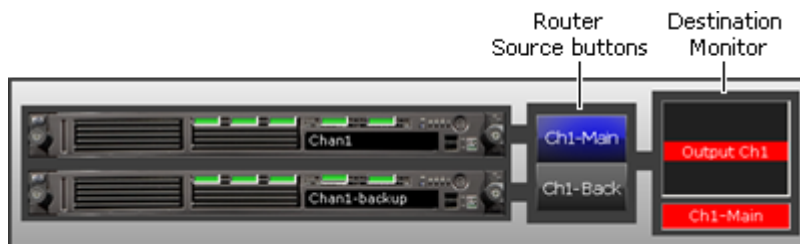

You can use such a group for an iTX system in which primary and back-up Output Server machines are connected as sources to a matrix router. The Channel Monitors give a visual indication of the health of the Output Servers that the router source buttons relate to.

Operating a router source button connects the associated channel to the destination represented by the Destination Monitor.

In configuring the components, you connect the Server Monitors and Channel Monitors to the services that they are to monitor; you map the Router Source buttons and the Destination Monitor to routers sources and a router destination.

### Dummy routing

You may set up failover routing to take place outside of the control of iTX. If you do, you need to configure the transmission-chain groups for a dummy router, through which you can simulate the actions of the real router.

### Connect the Server Monitor to a Database Server

1. Right-click a Server Monitor to display the component menu (you need to click near the edge of the component). Select **Properties**.  
The Available Server Controllers dialog appears. This displays a list of the IP addresses (and port numbers) of all the Server Controllers on the iTX network.
2. Select the entry for the Server Controller running on the Database Server machine. The **Currently Selected Server Controller** box displays your selection.
3. Click **OK** to close the dialog.  
The Server Monitor displays a service status indicator for each service on the Database Server machine. Provided the services are running normally, these indicators have green lights. [More details](#), page 98.

### Connect a Channel Monitor to an Output Server

1. Right-click a Channel Monitor to display the component menu (you need to click near the edge of the component). Select **Properties**.  
The Enter Channel Name dialog appears.
2. Enter the name of a playout channel in the **Name** box. This name must match the name you give the channel during installation; it is not case-sensitive. You can check channel names on the Channel Configuration pop-up layout.
3. Click **OK** to close the dialog.  
The Channel Monitor displays the channel name. Provided the services on the Output Server machine are running normally, the indicators on the Channel Monitor have green lights. [More details](#), page 98.

## Attaching an audio file to an Alert button

The Engineering layout contains a set of Alert buttons:

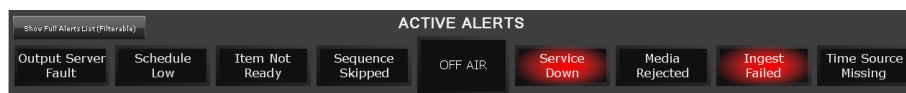

When building the layout, we configure these buttons to respond to specific alerts that the Alerts Service generates. A button flashes red if a particular condition arises and requires your attention. The label on the button describes the condition.

To help you to become aware of an alert condition when you are not viewing the layout, you may attach a sound file to each Alert button to provide an audible alarm; the sound file plays when the button flashes.

### Attach a sound file to an Alert button

1. Right-click an Alert button to display the component menu (you need to click near the edge of the component). Select **Properties**.

The Alert Button Properties dialog appears.

2. Click **Audio File** to display the standard Windows Open dialog.
3. Through this dialog, select an audio file.

The name of the audio file appears in the **Audio File** box.

4. Click **OK** to close the Alert Button Properties dialog.

#### Note:

- You can detach an audio file from an Alert button by clicking **Reset** in the Alert Button Properties dialog.
- You may follow the same procedure to attach a sound file to an Alert button on other layouts.

## Adding an Auto Failover Control to a layout

If your system includes a standby Output Server machine, you need to add an Auto Failover Control to a layout and connect it to the Server Controller on the standby Output Server machine.

This control enables you to select a schedule that is running in any main channel, and load it into the channel of the standby Output Server.

### Add and configure an Auto Failover Control

1. On a suitable layout in the editing mode, expand the categories ITX and FAILOVER in the Toolbox. Select the Auto Failover Control and drag it to a clear area of the layout.

The Auto Failover Control appears on the layout:

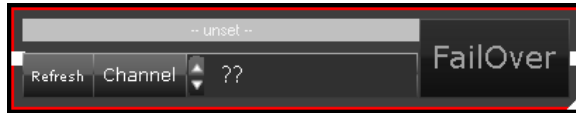

2. Right-click the Auto Failover Control to display the component menu (you need to click near the edge of the component). Select **Properties**.

The Available Server Controllers dialog appears. This displays a list of the IP addresses (and port numbers) of all the Server Controllers on the iTX network.

3. Select the entry for the Server Controller running on the standby Output Server machine. The **Currently Selected Server Controller** box displays your selection.
4. Click **OK** to close the dialog.

In its service status box, the Auto Failover Control displays the name of the Server Controller on the selected machine:

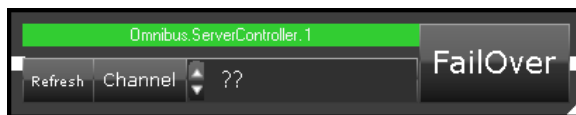

The green light in the box indicates that the Server Controller is running.

5. If you want to adjust the size or position of the Auto Failover Control, do the following.
  - To resize the control, drag the white triangle (in the bottom right corner).
  - To re-position the control, click it near any of its edges and drag it.

## Configuring component groups

You can modify various properties of a Group component: its size, text label, and appearance. To do so, you use the Group Properties dialog:

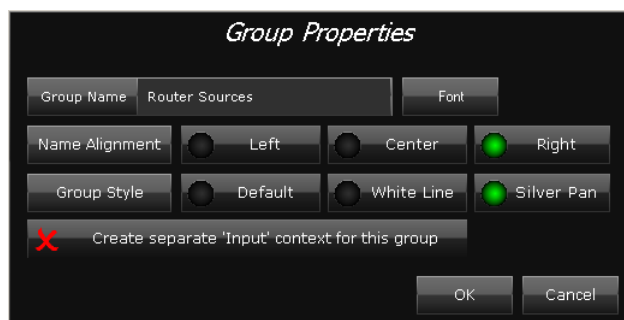

You select the dialog from the component menu. Before displaying the menu, you may identify the Group component by clicking a clear part of it: a red border appears around the group. If you click any of the components within the group, the border appears around that component instead.

## Change the properties of a Group component

1. Right-click the component and select **Properties** from the displayed menu.  
The Group Properties dialog appears.
2. If you want to change the group label, enter the new text in the **Group Name** box. Set the text appearance by clicking **Font** and selecting a font, style and size. Align the label by clicking **Left**, **Center** or **Right**. Delete the text if you do not want the group to display a label.
3. Set the appearance of the component by clicking **Default**, **White Line** or **Silver Panel**.
4. Click **OK** to close the Group Properties dialog.

## Configuring the PinPoint panel on the Asset layout

When using PinPoint to search for assets, an operator can request PinPoint to include assets of all types in search results or just assets of a particular type. The operator selects an option through the Asset Type buttons, which appear at the top of the PinPoint panel:

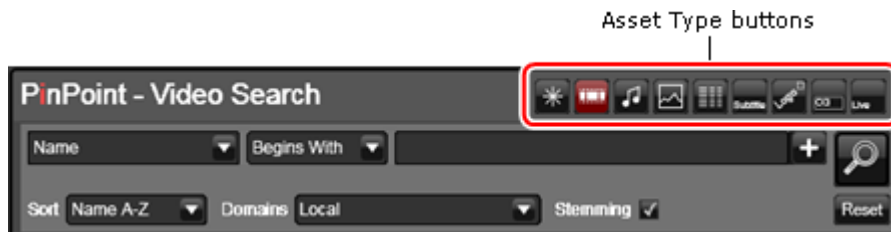

You can change the number of Asset Type buttons that appear on the panel and the types of asset they represent. For this, you use the PinPoint properties dialog:

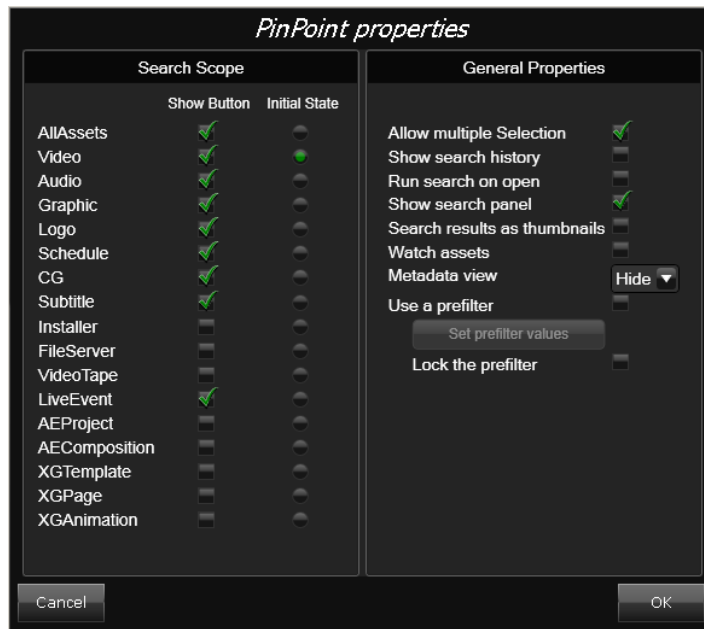

The available buttons are listed in the Search Scope pane. You can switch a button on or off by selecting or clearing its check box in the Show Button column; you can set a single button to be the default selection by selecting it in the Initial State column.



Although the dialog allows you to set other properties for the panel (in the General Properties pane), you should not normally change any of these.

## Configure the group of Asset Type buttons on the PinPoint panel

1. Right-click the PinPoint panel to display the component menu (you need to click near the edge of the component). Select **Properties**.  
iTX displays the PinPoint Properties dialog.
2. Do the following to configure the button group.
  - In the Show Button column, select the check boxes of buttons you want to appear on the panel.
  - Clear the check boxes of other buttons.
3. In the Initial State column, select the button you want to be selected by default when the iTX Desktop is started.
4. Click **OK** to close the dialog.

## Configuring search buttons on the Asset layout

An operator uses search buttons on the Asset layout to run PinPoint, the iTX search tool, to search the System Database for assets. These buttons have PinPoint search criteria preset for them; you may change the preset criteria for any button.

### Set the PinPoint search criteria for a search button

1. Right-click a search button to display the component menu (you need to click near the edge of the component). Select **Properties**.  
iTX displays the PinPoint Search Button Properties dialog.
2. To rename the button, enter a name in the **Button Name** box.
3. Ensure the **Search Scope** box shows the name of the asset type you want PinPoint to search for.
4. Do the following to set the search criteria.
  - Click **Search Parameters** to open PinPoint.
  - Use PinPoint to define the search criteria.
5. Click **OK** to close the dialog.

When an operator clicks the search button, the assets that meet the search criteria appear in the PinPoint-panel results pane.

## Configuring Encoder Settings buttons

A **Settings** button is linked to each Encoder Control on various ingest layouts. The button stores settings that determine the properties of files created when the associated Encoder Control is used to record a video feed.

Any set of values for these settings can be saved as an encoding profile; selecting the profile recalls the saved values. This makes it easy for operators to set up an Encoder Control to create files with identical properties. The Settings button enables operators to manage profiles.

The Settings button itself has properties that can restrict the amount of control an operator has in changing encoding settings and managing profiles. You can modify these properties when a layout is in the editing mode.

1. Right-click a Settings button to display the component menu (you need to click near the edge of the component). Select **Properties**.

The Encode Setting Properties dialog appears:



The default settings (all options selected) give operators the right to:

- Select encoding profiles.
  - Change individual encoding settings.
  - Save and delete encoding profiles.
2. Ensure only required options are selected; cancel any option that is not required.
  3. Click **OK** to close the dialog.

## Configuring router components

For systems in which iTX operates a matrix router, components on iTX Desktop layouts enable you to switch sources to destinations on the router. The components are:

- Destination Button Panels.
- Source Button Panels.
- Destination Monitors.

You need to configure these components for your particular router in the way we describe here.

### Map destination buttons to router destinations

A Destination Button Panel enables you to select a destination that you want iTX to route a specific source to. It may contain any number of buttons, depending on how many active destinations there are on a router.

To configure a panel, you need to associate destination buttons with physical router destinations. You do this through the Router Button Panel Configuration dialog:

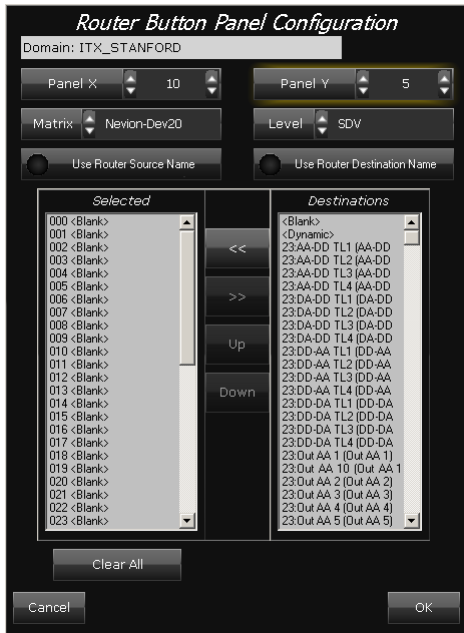

1. Right-click a Destination Button Panel, close to its edge, to display the component menu. Select **Properties**.

The Router Button Panel Configuration dialog appears. The **Panel X** and **Panel Y** boxes show the number of buttons in the panel. You may change the values in these boxes.

2. Do the following to set up the destination buttons.
  - Select a matrix router in the **Matrix** box.
  - Select SDV or another type of video signal in the **Level** box. This setting affects the button appearance, which indicates when the specified signal is present.
  - Select one or more router destinations in the Destinations pane; select the same number of blank entries in the Selected pane; click  to overwrite the blank entries with the selected destinations.
  - Leave the other options unchanged. Selecting **Use Router Source Name** and **Use Router Destination Name** causes the buttons to display router-crosspoint names instead of aliases.
  - Click **OK** to close the dialog.

On the layout, the mapped destination buttons appear active and display the names of the router destinations.

## Map source buttons to router sources

A Source Button Panel enables you to select a source that you want iTX to route to a selected destination. It may contain any number of buttons, depending on how many active sources there are on a router.

To configure a panel, you need to associate source buttons with physical router sources. You do this through the Router Button Panel Configuration dialog:



1. Right-click the Source Button Panel, close to its edge, to display the component menu. Select **Properties**.  
The Router Button Panel Configuration dialog appears. The **Panel X** and **Panel Y** boxes show the number of buttons in the panel. You may change the values in these boxes.
2. Do the following to set up the source buttons.
  - Select a matrix router in the **Matrix** box.
  - Select SDV or another type of video signal in the **Level** box. This setting affects the button appearance, which indicates when the specified signal is present.
  - Select one or more router sources in the Sources pane; select the same number of blank entries in the Selected pane; click  to overwrite the blank entries with the selected sources.
  - Leave the other options unchanged. Selecting **Use Router Source Name** causes the buttons to display router-crosspoint names instead of aliases.
  - Click **OK** to close the dialog.

On the layout, the mapped source buttons appear active and display the names of the router sources.

### Set up a Destination Monitor

A Destination Monitor specifies the destination that the selected source in a Source Button Panel is connected to. Its function is similar to that of the destination button in a Destination Button Panel; it displays the name of the connected source in a UMD (under-monitor display) slot.

In a transmission-chain group, you need to associate the Destination Monitor with the router destination for the transmission system.

1. Right-click the Destination Monitor, close to its edge, to display the component menu. Select **Properties**.

The Router Monitor Configuration dialog appears.

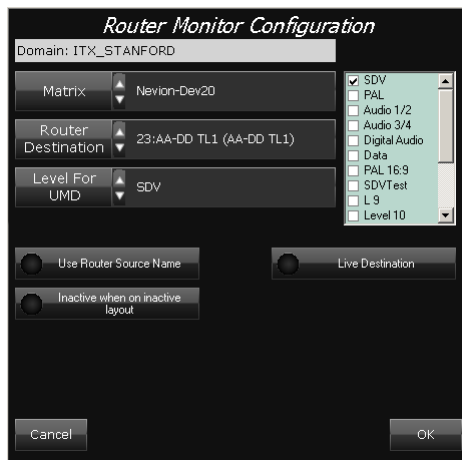

2. Do the following to set up the Destination Monitor.
  - Select a matrix router in the **Matrix** box.
  - Select a router destination in the **Router Destination** box.
  - Select SDV or another type of video signal in the **Level For UMD** box.
  - In the levels list (on the right), select the signal levels you want to include in routing operations; clear the check boxes of the other levels.
  - Leave the other options unchanged.
  - Click **OK** to close the dialog.

The Destination Monitor displays the name of the router destination; below this, it displays the name of the connected source.

## Configuring the hold time for the previewing of events

Your system may include a customised Channel Control or Multi-Channel Control layout that is configured to display, on a preview monitor, the next event that is to play out in any selected channel.

When either of these components is linked to a Destination Monitor (which may be hidden on the layout), they have an extra property called **hold time** – this controls the amount of time for which the preview monitor displays each event.

Depending on which layouts are set up to provide this functionality, you may:

- Configure the hold time for the Channel Selector.
- Configure the hold time for the Timeline Display.

### Configure the hold time for a Channel Selector

1. On a Channel Control layout, right-click the Channel Selector to display the component menu (you need to click near the edge of the component).

2. Select **Properties**. iTX displays the Channel Selector properties dialog.
3. In the **Hold time (frames)** box, enter a value for the amount of time that iTX displays the next event for on the preview monitor.
4. Click **OK** to close the dialog.

### Configure the hold time for a Timeline Display

1. On a Multi-Channel layout, right-click the Timeline Display to display the component menu (you need to click near the edge of the component). Select **Properties**.  
iTX displays the Timeline Display properties dialog.
2. In the **Hold time (frames)** box, enter a value for the amount of time that iTX displays the next event for on the preview monitor.
3. Click **OK** to close the dialog.

## Configuring Re-cue control

The Re-cue control can be configured to operate in “Follow On Air Item” mode. When in this mode, clicking Re-cue will stop and re-cue current on air item without the operator having to select it in the schedule grid.

### Configure Re-cue to enable “Follow on air item” mode

1. On a Re-cue Control layout, right-click to display the component menu (you need to click near the edge of the component). Select **Properties**.  
iTX displays the Re-Cue properties dialog.
2. Click to enable **Follow on air item**. The indicator will turn green.
3. Click **OK** to close the dialog.

## Making a layout global

When you add a cloned layout to your user view, the layout is not automatically available to other iTX users. To enable it to be included in all user views and workstation views, you need to make it a global layout.

1. With the layout selected, right-click the title bar (or a clear area of the layout) to display the iTX Desktop menu. Select **Layout** and then **Make Layout Global** from the iTX Desktop menu.  
The Make Layout Global dialog is displayed.
2. Change any layout details you want to; click **OK**.  
The layout becomes a global layout.

## Saving a layout

Each time you make a change to a layout, you should save the layout. Doing so changes the global layout in the System Database, and so affects the layout for all users (when the users restart their iTX Desktop). [More details](#), page 100.

1. With the layout selected, right-click the title bar (or a clear area of the layout) to display the iTX Desktop menu.
2. Select **Save Layout**.

## Exiting the layout-editing mode

**Important:** When you finish making changes to a layout, you should exit the layout-editing mode to prevent any further changes to the layout.

1. With the layout selected, right-click the title bar (or a clear area of the layout) to display the iTX Desktop menu.
2. Select **Edit** to uncheck the option.  
The layout returns to the normal operating mode.

## Cancelling unsaved changes to a layout

If you want to restore an iTX Desktop layout to a previous state, after making changes to it that you have not saved, you should exit the iTX Desktop without saving your changes.

1. Right-click the title bar, or the iTX logo; select **Exit** from the displayed menu.

The iTX Desktop displays the Closing Layout dialog:



2. Click **No**.

The iTX Desktop closes. When you restart it, it displays the layout in its original state or (if you have saved any changes) its latest saved state.

## Configuring channels

When the iTX installer creates playout, edit and cache channels for an Output Server machine, it selects options and sets values for some basic channel properties.

After starting the services on the machine for the first time, you should check the default channel settings and make any adjustments that your system requires. To do so, you use the Channel Configuration pop-up layout. This layout, which you display from the Engineering layout, contains features that enable you to perform the following tasks.

- Modify the properties of a channel.
- Set options for channel plug-ins. Plug-ins are software components that give channels extra functionality. Different iTX systems may have different sets of plug-ins.

The features you use for these tasks are arranged under the following tabs on the pop-up layout:

- Channel tab
- Plugins tab
- System Wide Config tab

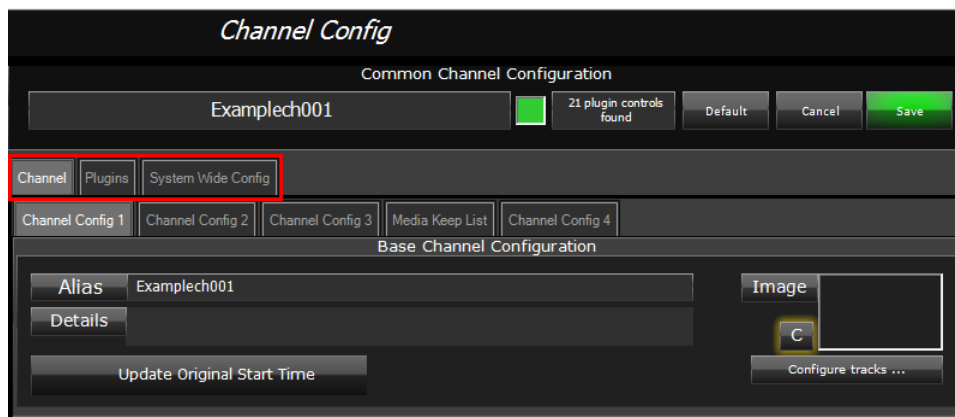

After changing channel settings, you may need to restart the services by restarting the Server Controller on the Output Server machine.

### Display the Channel Configuration pop-up layout:

1. Select the Engineering layout.
2. Click **Channel Config** in the System Management panel.  
The Channel Configuration pop-up layout appears in front of the Engineering layout.
3. When you complete your configuration changes, close the layout by clicking **Close**.



## System Wide Configuration

Unlike the Channel and Plug-ins configuration tabs, anything within the System Wide Config tab applies across all channels. Therefore, the options within this tab should be used with caution.

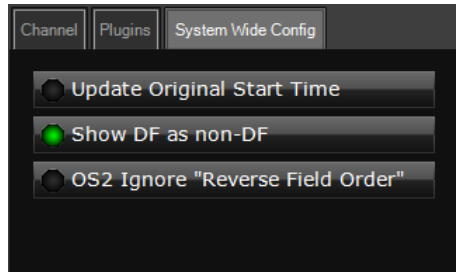

### Update Original Start Time

All playout schedules in the System Database include an Original Start Time field. In this field, iTX enters the start time assigned to each schedule event the first time the event is added to the System Database; this is normally when the schedule containing the event is imported. The entries can be viewed in the Original Start Time column in the Schedule Grid on the Channel Control layout.

If a schedule is modified and re-imported, these entries may be different to those in the previous version of the schedule. Then, depending on particular broadcasting requirements, it may be wanted to view either the updated start times or the first-recorded start times. iTX can be set up for either of these scenarios.

By enabling **Update Original Start Time** on the System Wide Config tab on the Channel Configuration pop-up layout, iTX can be set up to update original start times if they change.

This feature can also be overridden on a channel-by-channel basis. See “Update Original Start Time (channel override)” on page 138.

### Displaying drop frame time codes as non-drop frame time codes

The **Show DF as non-DF** button toggles the display and editing of drop frame time codes as though they were actually non-drop frame time codes. The table below illustrates the effect this has on timecodes:

Frame count	Ticks	Drop frame time codes (Show DF as non-DF off)	Non-drop frame time codes (Show DF as non-DF off)
1798	599933266	00:00:59:28	00:01:00:00
1799	600266933	00:00:59:29	00:01:00:01
1800	600600600	00:01:00:02	00:01:00:02

Non-drop frame time codes can be seen on media durations and time of day timecode fields, for the following event types:

- Video Clips
- Audio events
- Music events
- Live events
- Segment events
- Schedule events
- GPI events

The modified media duration and time of day timecodes can be seen in the following areas:

Layout	Component
TV Asset Layout	PinPoint
	Preview Window
	Asset Tab
	Locations Tab
Radio Asset Layout	PinPoint
	Preview Window
	Asset Tab
	Locations Tab
TV Channel Control	Content Selector
	Schedule Grid
	Item Edit Control (Clip selected in Grid)
	Item Edit Control (Live Event selected in Grid)
Radio Channel Control	Content Selector
	Schedule Grid
	Item Edit Control (Music Clip selected in Grid)
TV/Radio Channel Control with Global Edit	Global Edit Control

Layout	Component
Tape Ingest	PinPoint
	Mark In Out
	Batch Ingest Control
	Manual Control
	Schedule Grid
Ingest Manager	Schedule Grid
	Instant Ingest Booking

**Note:** When the **Show DF as non-DF** configuration option is enabled:

- The option will automatically save when changed.
- The Opus Service and the iTX Desktop both need to be restarted.
- Following a restart, the OPUS service will need to be re-indexed to ensure the correct format is displayed in PinPoint. For more information see “Re-indexing the Opus service” below.

### Re-indexing the Opus service

To ensure the correct timecodes for media durations are displayed in PinPoint, the Opus Service needs to perform a re-index. This is a 2-stage process. The first stage involves creating a shortcut to the Opus Service that will perform a re-index when run; the second stage involves temporarily stopping the Opus Service under Server Controller while the re-indexing shortcut is run.

**Note:** Opus search will be offline while the re-index takes place. In a load balanced system, Opus services should be either:

- Re-indexed individually to maintain continuous searches
- All re-indexed at the same time during a maintenance window.

**To create a shortcut to the Opus Service to perform a reindex:**

1. In Windows Explorer, browse to C:\Program Files (x86)\iTX 2.0\Services\OPUS Service
2. Right-click on the application file Omnibus.OPUS.Service.exe and choose **Create Shortcut**. A shortcut file will appear called Omnibus.OPUS.Service.exe - Shortcut
3. Right click on Omnibus.OPUS.Service.exe - Shortcut and choose **Properties**. The **Omnibus.OPUS.Service.exe – Shortcut Properties** window appears.
4. The **Target** field contains the path and file name for the Opus Service. For example "C:\Program Files (x86)\iTX 2.0\Services\OPUS Service\Omnibus.OPUS.Service.exe"

Append **-reindex** to the **Target** path and file name, as shown in the example below.

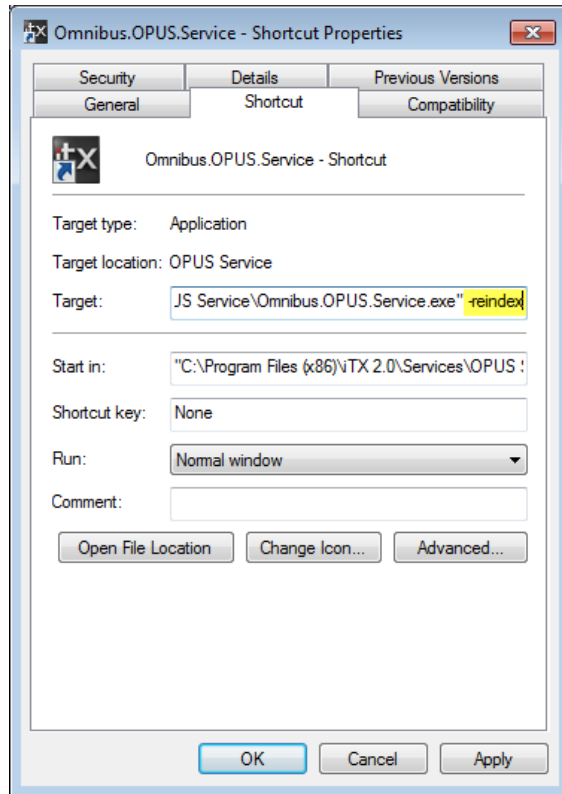

5. Click **OK** to close the Properties dialog.

**To perform the Opus re-index:**

1. On the framework server running Opus service, switch to the **Server Controller** window and select the **Controlled Services** tab. All of the iTX services running on the framework server will be listed.
2. Right click on the entry for **Opus Service** and choose **Stop Service**. A confirmation window appears asking if you are sure you want to stop the select service.
3. Click **Yes** on the confirmation window. The **Status** for the Opus Service will change to Stopped.
4. Double-click on the updated `Omnibus.OPUS.Service.exe - Shortcut`.

A new, stand-alone instance of the OPUS Service starts and reindexes all of the entries for durations to match drop frame configuration in System Wide Config. The reindex may take several minutes, depending on the size of your iTX database.

5. Once the reindex has completed, the stand-alone Opus Service should be stopped and the instance under Server Controller restarted.

Switch to the stand-alone Opus Service. Click the close button in the top right corner.

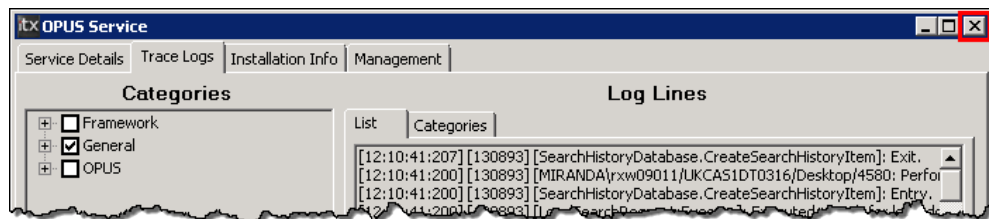

The stand-alone Opus Service will close down.

6. Switch to the **Server Controller** window and select the **Controlled Services** tab.

7. Right click on the entry for the original **Opus Service** and choose **Restart Service**. A confirmation window appears asking if you are sure you want to start the select service.
8. Click **Yes** on the confirmation window. After a few moments, the **Status** for the Opus Service will change to *Running*.

By ending the stand-alone Opus Service that performed the re-index and restarting the original Opus Service running under the Server Controller, you ensure the service will continue to run un-interrupted.

## Restricting Asset Search by Channel

The **Restrict Asset Search by Channel** option prevents operators from loading schedules or segments that are not for the selected channel.

When this option is enabled, the channel's root name (as defined in TXPlay Config) is added as a pre-filter in PinPoint in the following situations:

- When the user clicks **Search** in the **Content Selector** for schedules or sequences
- When the user clicks **Load** in the **Schedule Management** component.

The channel restriction appears as the first filter in the PinPoint - Schedule Search, as shown below:

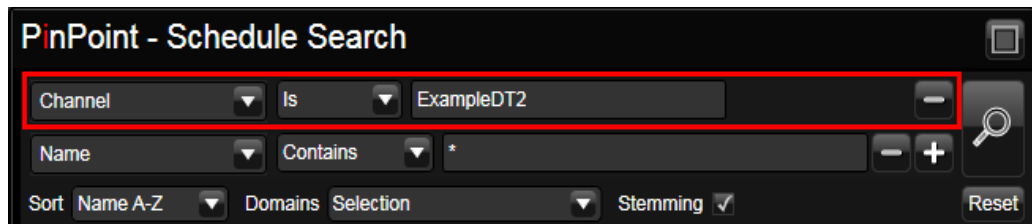

This means only schedules or segments for the selected channel will be returned in the search results. Schedules or segments with no channel name will not appear in the results.

## Modifying the properties of channels

### Select a channel for configuration

You need to select a channel before you can change its configuration.

To do so, you use the View Selector to select any view that includes the channel; you then select the channel in the Channel Selector.

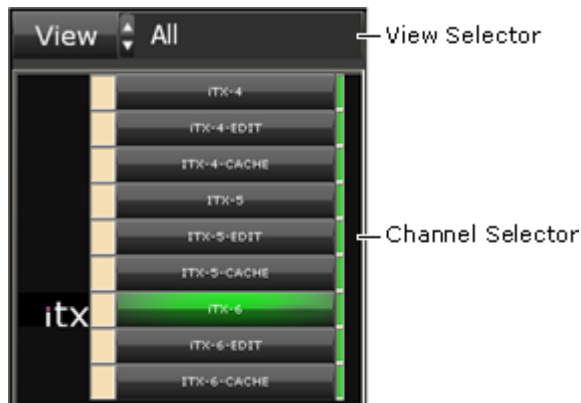

The text box in the Common Channel Configuration panel shows the channel name:



### Set channel properties

1. Select a channel.
2. Use the features under the Channel tab to set the new properties. [More details](#), page 136.  
The **Save** button flashes green to indicate there are unsaved changes.
3. Click **Save**.  
ITX updates the channel properties. The **Save** button stops flashing.

**Note:**

- You can cancel any changes by clicking **Cancel** instead of **Save**.
- You can restore the default settings by clicking **Default**.

### Using the Channel tab

You set the main channel properties under the Channel tab of the Channel Configuration pop-up layout. The features you use to do this are grouped under sub-tabs under the Channel tab.

For a playout or edit channel, there are five sub-tabs:

- Channel Config 1
- Channel Config 2
- Channel Config 3
- Channel Config 4
- Media Keep List

For a cache channel, there is an extra sub-tab:

- Cache Settings

For a scheduled ingest channel, there are two extra sub-tabs:

- Scheduled Booking Config
- Ingest Config

Below, we give details of the various settings you can make. Not all of them may be relevant to your system.

## Channel Config 1 – for all channel types

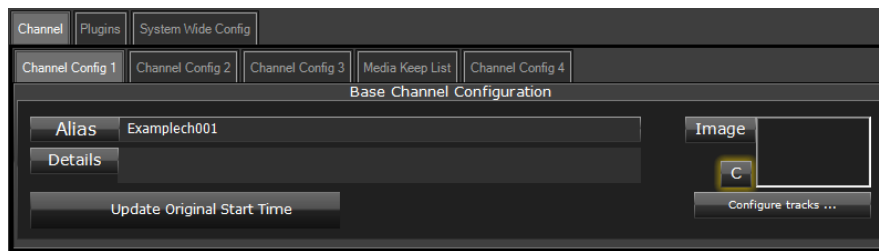

### Alias

In the **Alias** box, you can enter an alternative name for the channel. This is the name that identifies the channel on iTX Desktop layout features (e.g. channel selection buttons on a Timeline Display).

You should use an alias if you want these features to show different channel names at different times; for example, when using the iTX channel to play out schedules for differently branded channels. It is easier to change the alias than to rename the channel.

An alias does not change the main channel name, which identifies the channel in engineering features (service windows, logs, etc.).

### Details

In the **Details** box, you may enter any comments to remind yourself or inform other users about the use or configuration of the channel.

### Image

From the **Image** button, you can open PinPoint (the iTX search tool) and select a channel logo. The logo, which appears in the **Image** box, identifies the channel on features (the Timeline Display and Channel Selector) on the Channel Control layout.

Clicking **C** clears the channel logo.

### Configure tracks

From the **Configure tracks** button, you can open the track-configuration dialog and specify the default tracks that are to be represented on the Timeline Display (on the Channel Control layout).

In the track-configuration dialog, do the following to specify the default tracks.

- In the Available Tracks list, select one or more tracks; press Shift or Control while clicking track names to select multiple tracks. Clicking **Select All** selects all tracks (while clicking **Clear All** de-selects all tracks). Clicking **Alpha** causes the tracks to appear in alphabetical order, or the standard order, in the Available Tracks list.
- Click **Add** to add the selected tracks to the Selected Tracks list.
- If you want to remove any track from the Selected Tracks list, select the track and click **Rem.**
- If you want to change a track's position on the Timeline Display, select the track in the Selected Tracks list; then click **Up** or **Down**.

You can also configure how you want the events to appear on the Timeline Display.

- Select **Collapse Tracks** to display all events on a single horizontal track.
- Ensure **Collapse Tracks** is not selected if you want events of different types to appear on separate horizontal tracks.

### Update Original Start Time (channel override)

Individual channels can be exempted from the global **Update Original Start Time** setting in System Wide Config. This is controlled through the setting of the Update Original Start Time channel configuration button under the Channel Config 1 tab.

The button has three states, to apply the global setting, to update original start times overriding the global setting or do not update original start times, overriding the global setting, as shown below:

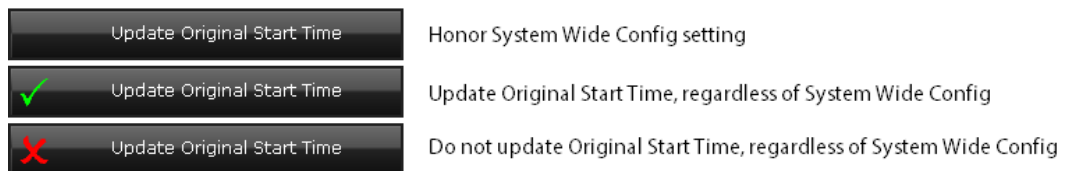

For each channel, the effect of changes to an on-air schedule is controlled through the **Auto Update On-Air Schedules** option on the Schedule plugin. When enabled, the on-air event, history events and events within the schedule lockout period are not affected by the update. See “The Schedule Event Configuration panel” on page 173.

## Channel Config 2 – for playout, edit and scheduled-ingest channels

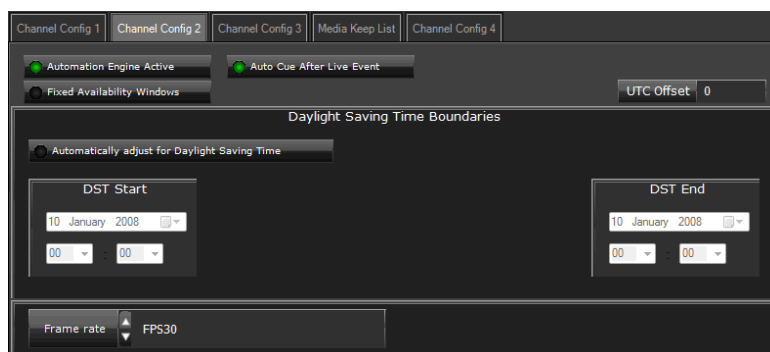



## Automation Engine Active

You must select this option for a playout channel, so that iTX processes schedules in that channel. It is not necessary to select the option for an edit channel.

## Auto Cue After Live Event

When **Auto Cue After Live Event** is enabled, any clips that follow live events and whose start times are within 20 seconds are automatically cued when an operator clicks 'Take Next' (in iTX Desktop, Master Control or Studio Switcher).

## Fixed Availability Windows

In the Event Editor, an operator can restrict the use of a sequence to a defined period called a break window. This period may be fixed – between specified times on a specified date; or it may be relative to the scheduled start time of the sequence.

When **Fixed Availability Windows** is selected, an operator specifies both the date and time for the start and end of the break window. When this is not selected, an operator specifies start and end times for the break window that are relative to the start time of the sequence.

## UTC Offset

If your iTX system is using a UTC time reference, you can set up iTX to display local time on layout features (e.g. the Schedule Grid or Event Editor). To do so, you specify the required offset (in hours) in the **UTC Offset** box. You may enter any value that is a multiple of 0.5 hour. For example: 1 hour; 1.5 hours; -2 hours.

### Note:

- For this setting to be effective, the channel must receive the time in UTC from the Time Service.

## Daylight Saving Time Boundaries

To enable iTX to automatically apply daylight saving time (DST) to a channel, select **Automatically adjust for Daylight Saving Time**. iTX adds an hour to the channel's local time (with the UTC offset, if applicable) between the DST Start and DST End boundaries you set.

- To set the DST Start, select the date DST starts; then select the time it starts, in the channel's local time (with the UTC offset, if applicable).
- To set the DST End, select the date DST ends; then select the time it ends, in the channel's local time (with the UTC offset, if applicable).

For example, if DST starts and ends at 01:00 UTC:

- If the channel's local time has no UTC offset, select a DST Start and DST End time of 01:00.
- If the channel's local time has a UTC offset of +4, select a DST Start and DST End time of 05:00.

### Note:

- For this setting to be effective, the channel must receive the time in UTC from the Time Service.

### **Frame rate (Output Server 1 only)**

In the **Frame rate** box, select the required speed in frames per second (fps) of the video output. Note that, for progressive scanning, the frame rate equals the field rate; so, for example, the frame rate required for a 720p video output is 50 or 60 fps.

**Note:**

- This section is only available to channels running the Output Server 1 service. For channels running Output Server 2 see the *Output Server 2 Channel Configuration Guide*.

## Channel Config 3 – for playout channels

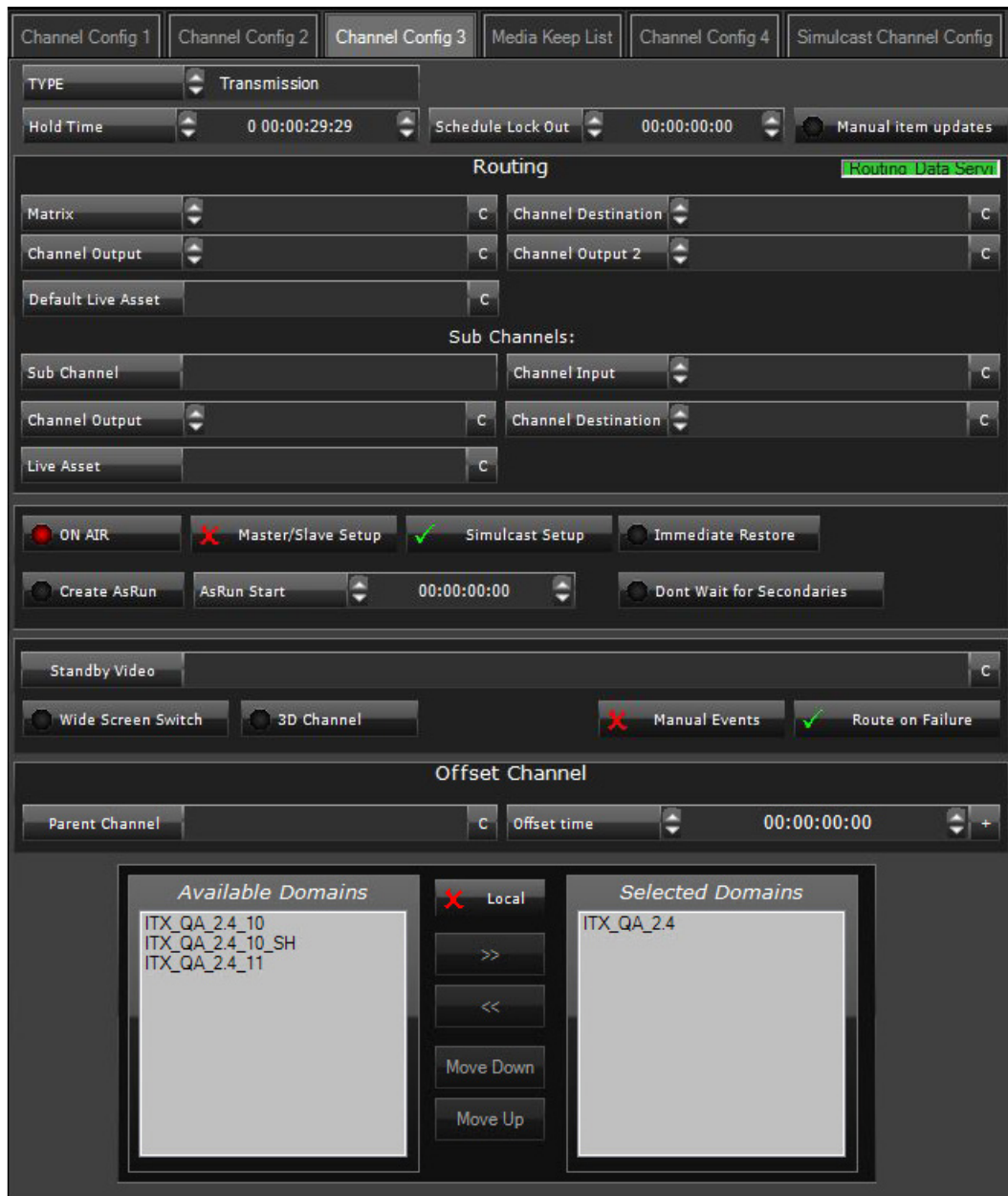

### Type

In the **Type** box, you select the channel type.

- **Transmission** channel type is for automated schedule playout control.
- **News** channel type provides functionality that is particularly relevant to a live News studio environment, with more manual control of playout. News channels need to be more responsive to user intervention than a transmission channel. An iTX News channel uses a specialised version of TX Play tailored for these kinds of ‘ad-hoc’ operations, called TX Live. A News Channel requires additional configuration, **Enable Cue to First Frame** in order to facilitate typical News operations.

- **PassThrough** channel type is for a channel that inserts commercials into a live source. On a passthrough channel, the schedule contains commercial breaks; when the commercial breaks have played out, the channel automatically returns to the live source.
- **Semi-Auto News** channel type is used to set all MOS stories intended for another channel with a zero duration, so they do not interfere with the cuing of items for the current channel.

**IMPORTANT:** If you need to downgrade your iTX to a version earlier than 2.5, you must change the **Type** from **Semi-Auto News** to **News** *before* beginning the downgrade.

- **Insertion** channel type is for future development and not yet in use.

### Hold Time

In the **Hold Time** box, you can set the length of time for which iTX continues to hold events in the Schedule Grid (on the Channel Control layout) after they have happened. An operator can choose to show or hide these events, which we call history events.

### Schedule Lock Out

The schedule-lockout setting applies when iTX is set up to automatically update nested schedules in a playout channel. A nested schedule is one that is inserted in a main schedule. [More details](#), page 173.

The value in the **Schedule Lock Out** box defines the length of the schedule lockout period – a period when the live schedule is protected from automatic changes. The period starts when iTX receives an updated version of the nested schedule.

iTX re-loads all nested-schedule events that come after the lockout period, but leaves events that fall within the lockout period unchanged.

### Manual item updates

The setting of **Manual item updates** affects how iTX responds when the asset in a schedule event is modified on the Asset layout:

- With the option not selected, iTX automatically updates the schedule event.
- With the option selected, the Schedule Grid (on the Channel Control layout) displays a warning icon to alert the operator to the change. The operator may accept the warning – and update the event – or ignore it.

### Routing panel



Through the routing panel, you enter details of sources and destinations for iTX to use when it is set up to operate a matrix router.

By selecting from available routers and crosspoints, you can enter these details:

- In the **Matrix** box, the name of the matrix router (or Router Bridge).
- In the **Channel Destination** box, the router destination on which the transmission system receiving the channel output is connected. iTX requires this entry if the channel is part of a master/slave setup. Any channel that is routed to this destination is, by definition, the master or leader channel. See later in this section, "Master/Slave Setup", page 144.
- In the **Channel Output** box, a router source that the channel output is fed into. iTX requires this entry if the channel is part of a master/slave setup. See later in this section, "Master/Slave Setup", page 144.
- In the **Channel Output 2** box, any router source you want to monitor. iTX can route this source to a monitor when the channel is selected on the Channel Control layout. This option is useful for monitoring the live video signal for a passthrough channel that is being fed into an Output Server machine.
- iTX can be set up to route the sources in the **Channel Output** and **Channel Output 2** boxes to video monitors when the channel is selected on the Channel Control layout.

Channel-selection components on iTX Desktop layouts can be configured to route the **Channel Output** and **Channel Output 2** sources to monitors for viewing.



Clicking **C** (to the right of any entry) clears the selection.

## Default Live Asset

Where a fixed or hardwired router source is used for a number of different live assets that are unknown to iTX, a default live asset can be substituted in each case without changing the unique names of the original live assets. Such a situation may arise in schedules delivered from a traffic system.

To configure this you need to enter the name of the default live asset in the **Default Live Asset** box:



You also need to clear the **Matrix** and **Destination** boxes on the Live Event Configuration panel:

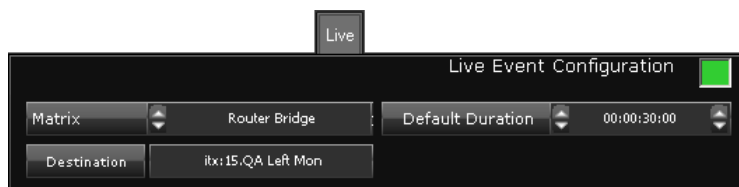

This will prevent iTX from assuming that the Live Event Source does not exist as a preconfigured routable source and therefore flag the item as Not Ready. Instead when the item cues, the default settings are deployed.

The default live asset is defined in the Asset Layout like any other, but the audio tracks for the asset **MUST** match the type and number of tracks that are in the source feed.

## Sub Channel Configuration

In a system that includes a matrix router and uses sub-channels to play out regional content, you set the router destination to which the live feed for a sub-channel is to be routed. You do this, for each sub-channel, by using the Sub Channels configuration area:



Sub Channels:	
Sub Channel	ITXDEVLAB-2#1
Channel Input	ibx:26.DevLab5 (26.DevLab5)
Channel Output	ibx:26.DevLab5 (26.DevLab5)
Channel Destination	
Live Asset	4.Sencore 1080i

In the **Sub Channel** box, you select the sub-channel you want to configure. You select the destination for the sub-channel's live feed in the **Channel Input** box. Clicking **C** (to the right of the **Channel Input** entry) clears the selection.

The Sub Channel's output to the router is configured in the **Channel Output** box.

In the **Channel Destination** box, you enter the router's output destination that you wish to have the sub channel routed to when it is on air.

Finally, the **Live Asset** box is where you set the default standby Live Source for the sub channel when there is an under-run. This allows the Sub Channel to switch to a feed if there is a gap in the schedule before the next item in order to prevent being off air or outputting black/freeze frames.

### Note:

- You use the routing panel to select the matrix router before setting the destination. [More details](#), page 142.

## On Air

A red light in the **On Air** button shows the channel is a live transmission channel. Select the option for a playout channel, so that the Alerts Service generates alerts when necessary. Cancel the selection for edit channels.

## Master/Slave Setup

For a system that has main and back-up Output Server machines, selecting **Master/Slave Setup** identifies the channel as one of a master-slave pair of channels. Either channel may be routed to the transmission system:

## Configuring channels

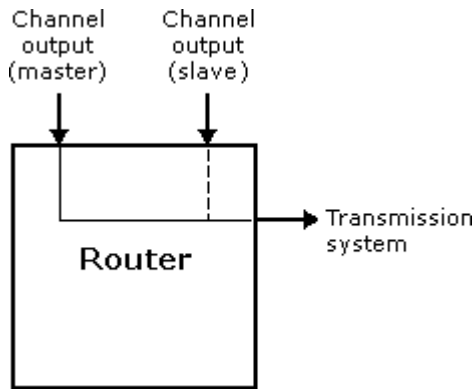

For each channel in a master-slave pair, details of router connections are required in the routing panel:

The **Channel Output** entry specifies the router source to which the Output Server is connected.

The **Channel Destination** entry specifies the router destination that is to deliver the output of the master channel.

## Simulcast Setup (Output Server 2 only)

For a simulcast system, which has one instance of TX Play 2 as a leader and another instance as a follower, selecting **Simulcast Setup** identifies the channel as one of the machines in the leader/follower network.

For more information see *Output Server 2 Channel Configuration Guide*.

## Create As Run

An as-run log contains records of schedule events that have played out. iTX creates as-run logs, for schedules it processes, when **Create AsRun** is selected. Select the option only if you want iTX to produce these logs.

iTX creates as-run logs in three forms:

- As text files, which it stores on the Database Server.
- As as-run schedules, which it stores in the System Database.
- As iXML files, via the iXML plug-in.

By default, iTX writes items to the AsRun log at the point both the primary and its secondary items have played out. This behaviour can be altered by enabling **Don't Wait for Secondaries** below.

### As-run text files

iTX names the text files DAY\_n.txt, where n is the day of the month. So, the filenames for a month range from DAY\_1.txt to DAY\_31.txt. Each time it creates an as-run log, iTX overwrites

any text file for the same day of a previous month. So at any time, it holds the logs for up to 31 days.

iTX stores the text files in a folder on the Database Server, on the drive on which you install the iTX software. The default path of the folder is:

C:\AsRun\*channelname*

## Don't Wait for Secondaries

When this option is enabled in conjunction with **Create AsRun**, the As Run log files will be written as each item in the schedule is played out, regardless of whether their primary or secondary items have also played out.

## As-run schedules

iTX bases the names of as-run schedules on the schedules from which they are created; it adds the suffix `_asrun` to the schedule name. For schedules without names, iTX names the as-run schedules after the channels in which they play out; it adds the same suffix, `_asrun`.

If you log onto iTX with an account that is a member of the Administrators or System group, you may use PinPoint to find an as-run schedule and load it in a ployout or edit channel.

## As-run iXML files.

In order to export as-run logs as iXML, you need to install the iXML As Run Plug In.

This is found in the installer selector under Database Server > iXML As Run Plug In. It is then configured via a new tab in the As Run Service itself.

Click the Add button to add the name of the channel and then browse to or type the location of the directory you would like your iXML files written to. Paths can be edited and channels can also be deleted if you no longer require as-run logs in this format for them.

Because the iXML is generated by extracting the information from the database including all stored asset metadata, this type of As Run log is described as 'data enriched'.

The As Run Service reads the information from the database and finds what metadata is stored for each media item that has been played out. It collates this information and, from it, creates an as-run log in XML format.



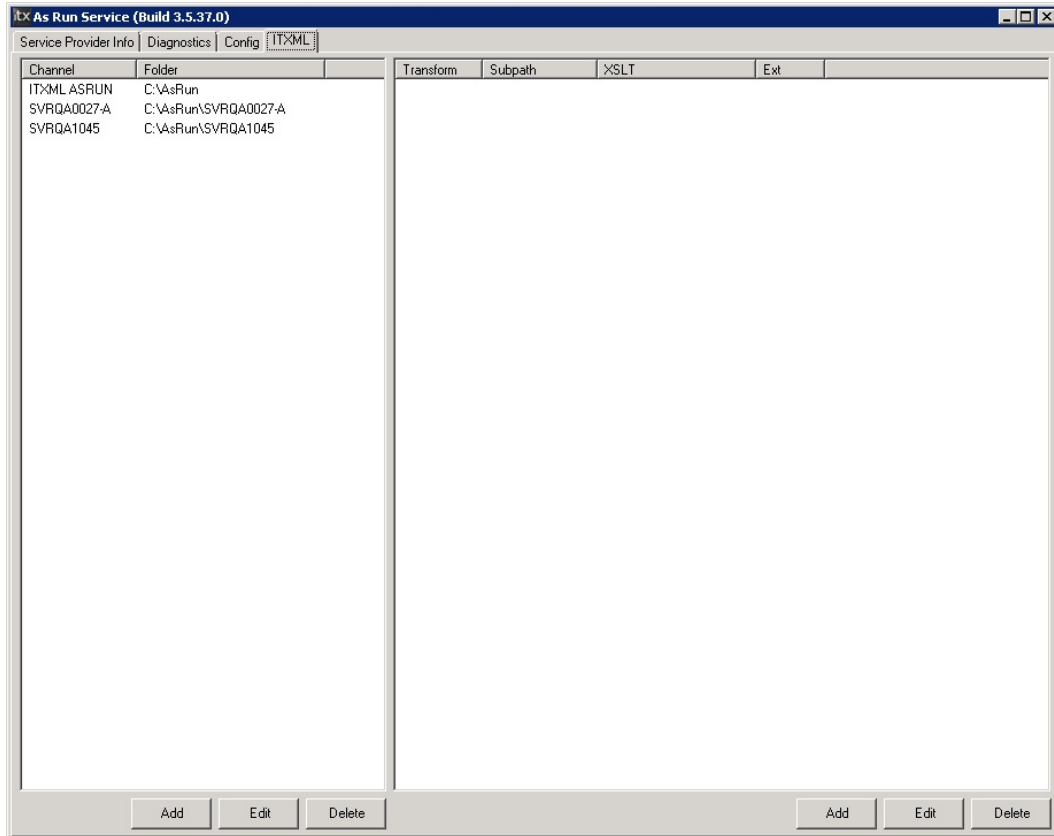

## As Run Start

This setting is only relevant for as-run logs in text files.

By default, an as-run log records schedule events that take place in the 24 hours of any given day. In the **AsRun Start** box, you can specify a start time so that iTX creates as-run logs for an offset 24-hour period; for example, from 4 a.m. one day to 4 a.m. the next .

In an as-run log with an offset, the hour figures increase past midnight on the second day (e.g. 25:00:00:00 represents 1 a.m.).

## Standby Video

In the **Standby Video** box, you can specify a video clip for iTX to play out if it cannot play the media file in a schedule event. iTX plays out the standby video – instead of a configured breakdown slide – until the next event. For this setting, you need to enter the path and filename of a video clip.

Clicking **C** (to the right of the **Standby Video** entry) clears the selection.

If you do not specify a standby video clip, iTX displays the breakdown slide; you configure this under the Channel Config 4 tab.

## Wide Screen Switch

For an SD channel, you select **Wide Screen Switch** if you want iTX to embed a WSS (widescreen signalling) stream in the transmission signal. This stream describes the aspect ratio (4:3 or 16:9) and television standard (PAL or NTSC) of a video clip. A television uses the stream to determine how it displays the video.

This option does not apply to HD channels.

## 3D Channel

Select **3D Channel** for a channel that is to deliver stereoscopic-3D content.

## Manual Events

If you want all new primary events to be created as manual events as an operator adds them to a schedule, select **Manual Events**.

## Route on Failure

For a system that has main and back-up Output Server machines, selecting **Route on Failure** allows iTX to operate the router to connect the back-up Output Server to the transmission system if the main Output Server fails.

**Important:** You should disable this option in a system that uses a standby Output Server to provide backup cover for a group of Output Servers. (This is sometimes called an *n+1* redundancy configuration.)

You should also disable this option in a system that uses a dummy router.

## Offset Channel panel

You use this panel to configure a transmission channel as a secondary channel.

A secondary channel is a mirror of its parent channel. Its purpose is to play out the same schedule as the parent channel, but at a different time – usually later, but it could be earlier. All schedule editing is done in the parent channel; it is automatically repeated in the secondary channel.

In the **Parent Channel** box, you select the parent channel for the secondary channel. Clicking **C** clears the selection.

You can set the secondary channel to have an offset from the parent channel; for example, to delay the start time of the schedule in the secondary channel by an hour. To do so, you specify the required offset in the **Offset time** box.

- To delay playout in the secondary channel, specify a positive offset by clicking the button to the right of the **Offset time** box; ensure the button displays a plus sign.
- To start playout in the secondary channel early, specify a negative offset by clicking the button to the right of the **Offset time** box; ensure the button displays a minus sign.

## Search-domains panel

Through the search-domains panel, you may set up a channel to use its own search domains list instead of the central list that you configure in the Media Watcher. [More details](#), page 91.

The panel is similar to the one under the Domains tab of the Media Watcher user interface. It has an extra button:



You use this button to switch the channel between using the local configuration and the central one.

**Note:**

- If you set up TXPlay to use a local domain search list, you must set up the Media Cache Service on the same machine to use an identical list.

## Channel Config 4 – for playout channels



## Output Server

This section only appears for channels running on Output Server 1. For more information see [Using the Configure Output Server dialog \(Output Server 1 only\)](#) on page 155.

## Off Air Slide

From the **Off Air Slide** button, you can open PinPoint (the iTX search tool) and select a still image that iTX is to play out when no schedule is running.

Clicking **P** opens a preview window displaying the off-air slide. Clicking **C** (to the right of the **Off Air Slide** entry) clears the selection.

## Breakdown Slide

From the **Breakdown Slide** button, you can open PinPoint (the iTX search tool) and select a still image that iTX is to play out when a system failure causes an interruption to a schedule. iTX plays out the breakdown slide if there is no standby video clip specified under the Channel Config 3 tab.

Clicking **P** opens a preview window displaying the breakdown slide. Clicking **C** (to the right of the **Breakdown Slide** entry) clears the selection.

## Take Next Sequence

On some channels, you may want iTX to delay the start of a sequence, for a short interval, after it receives a request to play the sequence. You specify the length of such a delay in the **Delay** box.

The setting affects sequences that are started manually by an operator and those triggered by GPIs. It does not affect sequences triggered by SCTE 104 signals.

## Manual Takes panel

You usually select **Ignore Secondary Events** (the button indicator displays a red light). This sets up iTX to always take the next primary event on the operation of the **Take Next** button – even when there are secondary events due to play out before the primary event.

In the **Delay** box, you specify the length of any delay that iTX should introduce between the operation of the **Take Next** button and the start of the event controlled by this operation. Although the setting is normally zero, a delay may be necessary for operational reasons. For example, to ensure the next events in a group of channels start at the same time when an operator clicks the **Gang Take Next** button, you may enter a delay of 2 seconds; you need to enter the same value for all the channels in the group.

## Default Transitions panel

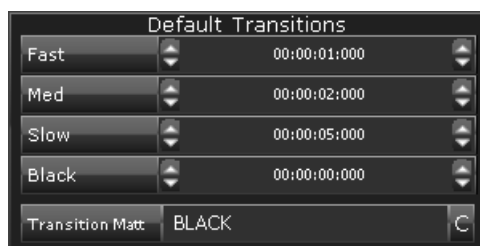

The values that you set in the preset transition-rate boxes (**Fast**, **Med**, and **Slow**) are for event transitions. The associated value appears in the **Dur** box on the Event Editor when an operator clicks a preset transition-rate button.

In the **Black** box, you specify the default duration of the display of black frames in a transition through black. The associated value appears in the black-hold dialog, which you display through the **Advanced** button on the Event Editor.

By default, iTX displays black frames in a transition through black. From the **Transition Matt** button, you can open PinPoint (the iTX search tool) and select a video clip for iTX to display, instead of the black frames, in a transition of this type. Clicking **C** (to the right of the **Transition Matt** entry) clears the selection; the entry returns to the default ("Black").

## Output Server panel

Clicking **Configure Output Server** displays a dialog that enables you to set properties of the output signal (e.g. the display resolution) and options that affect Output Server operations. See later in this section, "Using the Configure Output Server dialog", page 155, for instructions on using this dialog.

## Alerts panel

Clicking **Configure Alerts** displays a dialog that enables you to set properties for alerts that various services generate. See later in this section, "Using the Configure Alerts dialog", page 162, for instructions on using this dialog.

## Evergreen configuration panel

Evergreen content is standby content that iTX can play out when the media file required for a schedule event is unavailable.

When **Auto Replace** is selected, iTX automatically replaces any video-clip event on the iTX output server for which there is no media file at a specified time. By default, it does this when the time to the start of the event equals the duration of the event. So, a video-clip event with a duration of 30 minutes is replaced 30 minutes before its start time.

The minimum interval for the replacing of an event is 5 minutes; any schedule event with a duration of less than 5 minutes is replaced 5 minutes before its start time.

iTX replaces the video-clip event with a sequence (which can itself be easily replaced if the missing media file becomes available). In the sequence, iTX includes events based on evergreen media items, which it selects from a PinPoint results list. PinPoint creates the list of evergreen items by performing a search using search criteria that you specify. You can specify a different set of search criteria for up to 5 different periods, or "windows", in a day; this way, you can match the replacement items to the type of audience that the missing programme is intended for.

For the first event in the sequence, iTX uses the longest available evergreen media item that has a duration equal to, or shorter than, the media item in the original schedule event. iTX adds other evergreen events as necessary; it tries to make the sequence fit as closely as possible, but not exceed, the duration of the replaced schedule event.

Where the total duration of evergreen events falls short of the required duration, iTX displays the off-air slide for gaps of longer than 1 second; otherwise, it holds the last frame of the last event in the evergreen sequence on a freeze.

The time mode information of the clip being replaced is preserved and reassigned to the first item of the evergreen sequence, e.g. if the first clip in a commercial break is a fixed event with a manual hold, then the first clip of evergreen will have the same time mode settings.

Where multiple evergreen media items have the same duration, iTX selects the one least often used.

- You use the **Tolerance %** setting to allow variation in the duration of media items iTX can select to fill a gap. For example, when the tolerance setting is 10%, iTX can fill a gap of 30 minutes with any evergreen media item having a duration of 27 to 30 minutes.
- Selecting **Fixed Replace Time** allows you to define the point at which iTX replaces schedule events. In the **Minutes** box, you specify how long (5 minutes or more) before the start time iTX replaces a schedule event.
- In the **Window** box, you select the number of the window (from 1 to 5) that the specified search criteria is to apply to.
- In the **Start** and **End** boxes, you enter the start and end times of the selected window.
- You click **Select Clips** to open PinPoint and specify the search criteria for the selected window. To avoid the repetition of a media item in an evergreen sequence, you should ensure the search criteria results in a variety of media items with long, medium and short durations.
- Selecting **Advanced Replace** allows you to define the point at which iTX replaces schedule events that are not located on an iTX output server (e.g. an archive server). In the **Minutes** box, you specify how long (5 minutes or more) before the start time iTX replaces these events.

If the media file for a replaced schedule event becomes available before the start time of the event, an operator may delete the evergreen sequence and restore the original schedule event.

## Audio Mapping panel

Audio mapping involves selecting source audio tracks for up to 16 audio channels in the channel output signal.

For Output Server 1, see the separate section "Configuring the audio output for a playout channel", page 195, for instructions on using the Audio Mapping panel.

For Output Server 2, see the *Output Server 2 Channel Configuration Guide*.

## Advanced Aspect Ratio Control panel

As well as having different source formats (i.e. aspect ratios which may be 4:3 or 16:9), different video clips may display frames with different active regions. By active region, we mean the area of the video frame that contains the image.

With the Advanced ARC (Aspect Ratio Control) functionality, iTX can modify a video clip to fit the aspect ratio of a playout channel in a particular way, depending on the combination of the clip's source format and active region. It can also insert AFD (Active Format Description) data in the output video signal – this describes the video aspect ratio and active region for televisions.

In the Advanced Aspect Ratio Control panel, you configure iTX to use the Advanced ARC functionality:

- You select **Enable AFD Insertion** if you want iTX to insert AFD data in the output signal.
- Clicking **Configure Mapping** displays a dialog that enables you to specify how iTX should play out video clips with different combinations of source format and active region; also, what (if any) AFD value it should insert in each case. See later in this section, "Using the Advanced Aspect Ratio Control – Mapping Configuration dialog", page 163, for instructions on using this dialog.

Clips may already contain AFD data, so automatic insertion is not always necessary. Whether or not iTX should insert AFD data is determined on a clip-by-clip basis.

This is determined by the setting of an **insertion-mode** property for each clip.

The insertion mode has two types:

- **Pass Through.** iTX does not insert any AFD data, but transmits any such data that is contained in the VANC in the media file. This state is only possible when iTX has detected AFD data in the VANC.
- **Override.** iTX erases any existing AFD VANC data when playing out the media file and instead inserts AFD values that are defined in the asset record in the database or in a schedule event.

An AFD value maps to a combination of two asset properties: Source Format and Active Region.

When a file is ingested, iTX may read the values of these properties from the file header and include them in the asset record it creates in the System Database.

If the file does not contain values for these properties, iTX applies the values defined in the template that is used to create the asset.

For each of these cases, the default AFD insertion mode is **Override**. An operator may modify the AFD properties and insertion mode on the Asset layout.

Where iTX performs a deep analysis (currently possible on AVC-Intra and LXF files) it may detect an actual AFD code within the video data stream. Again, it uses this information to set the Source Format and Active Region values in the Asset record. But In this case, the default AFD insertion mode is **Pass Through**, to indicate use of the code embedded in the actual data stream.

## Nielsen Ratings panel (Output Server 1 only)

You select **Enable Nielsen** if you want iTX to insert a Nielsen watermark (an inaudible cue tone) in the audio stream of the channel output signal. In the US and Canada, the Nielsen watermark is detected by devices that provide information for television audience measuring.

iTX 2 supports both version 2 (N2) and version 4 (NW) watermarking. You can insert either format, or both simultaneously into the data stream.

### Note:

- This section is only available to channels running the Output Server 1 service. For channels running Output Server 2 see the *Output Server 2 Channel Configuration Guide*.
- Unlike N2 watermarking, NW processing does not support the overwriting of audio codes that are present in the stream before the watermarking process begins. Instead, the

watermark engine leaves space for a second (and possibly a third) Final Distributor SID in the program band.

From the **Configure Nielsen Ratings** button, you can display the Configure Nielsen Ratings dialog and specify the settings for the Nielsen watermark:

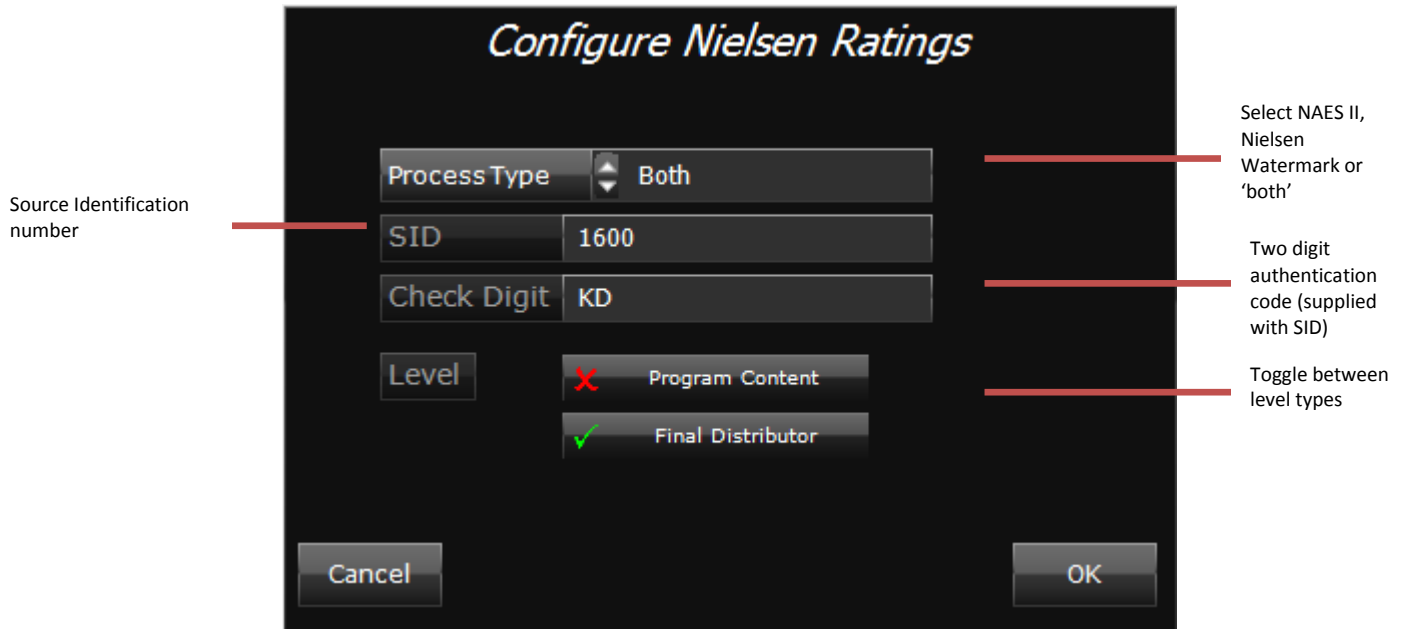

- In the Process Type selector select N2, NW or 'both'.
- In the **SID** box, enter the Nielsen channel ID number.
- In the **Check Digit** box, enter the two-letter Nielsen check digit.
- In the **Level** box, enter the Nielsen audio code type.

## Secondary Record

Via a Licensed plug-in, Secondary Record can be used to capture live events and sequences as played out from a live channel.

These recordings are registered with the iTX system as per any other ingested clip and can then be played out as part of a schedule, allowing a customer to replay items such as live sporting events without having to perform a separate ingests of an incoming feed.

Once a License key is obtained and registered with the database, the iTX software must be restarted (by shutting down the Server Controller) on the Output Server for the update to take effect.

When the software restarts, a separate iTX Encoder service will run up alongside the iTX Player service. This handles the creation of the secondary recording.

The default secondary record profile can be configured from the Channel Configuration pop-up available in the Engineering desktop layout via this dialogue box:



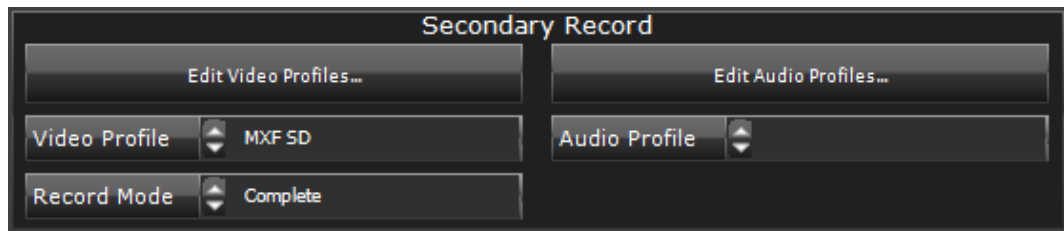

An Encoding profile (created as normal) is assigned to the channel along with the 'record mode' required. Default Encode Profiles can be used but new profiles for use with Secondary Record can be specially created via the 'Edit Profile' option.

There are four record modes available:

- **Complete** – Captures the video/audio exactly as it plays to air including all iTX keyed graphics and inserted data.
- **Before Branding** – Captures the video with iTX inserted data (subtitles, AFD information etc.) but without any keyed graphics
- **Before All** – Captures the video without any iTX keyed graphics or inserted data.
- **Channel Output** – This can be used to record the downstream output of the channel, but requires some special considerations as detailed below:
  1. Instead of writing rendered frames straight to file, the Encoder records the feed to the second video input of the AJA card. So the downstream output required to be captured (post graphics or data insertion chain) must be 'hard wired' to the second input. Without a valid video signal being sent to the input, the secondary record will fail.
  2. This mode means the AJA card **MUST** have two input connectors. The first for the feed used for live events and the second used to encode the channel's downstream output. Therefore only two models of AJA card are supported for this mode – the *Dual Corvid* and the *Kona 3G*.

**Master/Slave channels:** When a secondary record is scheduled on a master/slave channel pair the slave channel will capture the event with the asset name specified in the schedule as per the master but with a '-backup' suffix added to the asset name.

**NOTE:**

- Secondary record is not allowed on a channel that uses a local iTX Encoder for the purpose of IP Simulcast or Output Server 2 Simulcast.

## Using the Configure Output Server dialog (Output Server 1 only)

Clicking **Configure Output Server** under the Channel Config 4 tab causes the Configure Output Server dialog to appear. Through this dialog, you set properties that control the processing of the transmission signal and the delivery of the signal from the Output Server machine. The dialog has two distinct halves, which we describe here.

**Note:**

- This section is only available to channels running the Output Server 1 service. For channels running Output Server 2 see the *Output Server 2 Channel Configuration Guide*.

**General Output Server settings**

In the left half of the panel are general Output Server settings:

Resolution	HD1080i	<input checked="" type="checkbox"/> Restart on input resolution change	
AFD Type	SMPTE 2016-3 (VANC)	Reference	External
		Cache Throttle in MB/s	100
		OP47 Line	20
<input checked="" type="checkbox"/> SCTE 104 Signal		<input checked="" type="checkbox"/> SCTE 104 Replace Mode	
Seq Start SCTE 104 Op Code	1	Immediate Seq Start SCTE 104 O	2
Seq End SCTE 104 Op Code	3	Immediate Seq End SCTE 104 Op	4
<input checked="" type="checkbox"/> Enhanced SCTE 104			
SCTE 104 Event Mask	0	SCTE 104 Output Line	0
<input checked="" type="checkbox"/> National Breaks		<input checked="" type="checkbox"/> Local Breaks	
<input checked="" type="checkbox"/> Pass-Through Enable		<input checked="" type="checkbox"/> Pass-Through on Output Line	
<input checked="" type="checkbox"/> Suppress SCTE 104 Triggers on Slave			
<input checked="" type="checkbox"/> Broadcast Preview Active			
Target Address		UDP Port	1024
Stream	H264	Frame Rate (FPS)	12
Video BR (mb/s)	5	Width	360
Audio BR (kb/s)	96	Height	240
<input checked="" type="checkbox"/> Live Preview Active			
Target Address		UDP Port	1024

**Note:** The available options depend on the type of SDI video card in the Output Server machine.

**Resolution**

In the **Resolution** box, you select the display resolution of the video that the Output Server plays out.

## Restart on input resolution change

With **Restart on input resolution change** selected, you can use the live input to the Output Server to automatically change the display resolution of the channel at planned times of the day.

If the iTX Player detects a change in the display resolution of the video signal connected to this input, it informs TXPlay; this updates the setting for the resolution in the Output Server configuration and triggers the Output Server to restart; the Output Server then restarts the iTX Player, so that this plays out content at the new resolution.

You should ensure **Restart on input resolution change** is not selected if you do not want changes in the resolution of the input signal to affect the channel configuration in this way.

## Reference

In the **Reference** box, you specify the source of the timing reference signal that is supplied to the SDI video card in the Output Server machine.

## Cache Throttle in Mb/s

The Output Server controls the caching speed when it copies a media file from a Media Store to the Output Server cache. It sets this speed to the highest value that does not affect playout.

To reduce the load on the network, it may be necessary to reduce the maximum caching speed the Output Server is allowed to set. You specify the caching-speed limit in the **Cache Throttle in Mb/s** box.

### Note:

- The default setting is 100Mb/s. It is recommended that you do not enter a value lower than 40Mb/s to maintain stability.

## SCTE 104 Signal – for sequence control

The video signal to the SDI video card in the Output Server machine may contain SCTE 104 messages (also known as digital cue tones). iTX can detect such messages and respond to them. In doing so, it may start the playout of a sequence that is on hold in a schedule or end a sequence iTX is playing.

If you want iTX to respond to SCTE 104 messages, you need to select the **SCTE 104 Signal** option. You then need to enter, in the **Seq Start SCTE 104 Op Code** box, the message code that causes iTX to start the playout of a sequence; and, in the **Seq End SCTE 104 Op Code** box, the message code that causes iTX to end the playout of a sequence. Message codes may be any number between 0 and 255.

iTX responds to these codes after a delay which you set under the Engineering tab of the Output Server window. (You may set the delay to be zero.) [More details](#), page 246.

Some SCTE 104 messages may require an immediate response from iTX (i.e. without any preset delay). You need to enter the codes for these messages in the **Immediate Seq Start SCTE 104 Op Code** and **Immediate Seq End SCTE 104 Op Code** boxes.

**Note:**

- For iTX to work in this way, the operator must select the **Allow External Takes** option for the sequence in the Event Editor.
- It is not possible to have SCTE104 and Enhanced SCTE104 enabled at the same time.

**Enhanced SCTE104**

The Enhanced SCTE104 output server controls provide additional VANC commands and increased functionality compared to the standard SCTE104 output server controls. This includes:

- Processing of Multiple Operation Messages, which allows for both Local & National Avail Insert Commands and the ability to react to legacy DTMF triggers.

The following additional commands are supported when included as a part of a Multiple Operation Message.

- splice\_request\_data
  - splice\_insert\_type
  - Pre\_roll\_time
  - splice\_event\_id
- insert\_segmentation\_descriptor\_request\_data (which identifies local or national avail)
- insert\_DTMF\_descriptor\_request\_data
- The pass through of SCTE messages is also extended to include:
  - All inbound SCTE104 Messages can be either passed through or blocked.
  - Support for the following SCTE 104 messages, when received as part of a Multiple Operation Message:
    - splice\_request\_data()
    - time\_signal\_request\_data()
    - insert\_avail\_descriptor\_request\_data()
    - insert\_DTMF\_descriptor\_request\_data()
    - insert\_segmentation\_descriptor\_request\_data().
  - The ability to enable and disable pass-through messages.
  - When pass-through is enabled, iTX allows for the passing of “NULL” SCTE messages for heartbeating to downstream services.
  - Support for enabling or disabling pass-through applies to all commands within a Multiple Operation Message, not just individual splice\_insert\_type level commands.
  - Splice commands received outside of a configured available window are unchanged.
- Outbound SCTE messages support the following additional operations:
  - insert\_segmentation\_descriptor\_request\_data (which identifies local or national avail)
  - insert\_DTMF\_descriptor\_request\_data

**Note:**

- It is not possible to have SCTE104 and Enhanced SCTE104 enabled at the same time.

The table below describes the functions of the Enhanced SCTE 104 options:

Option	Description
Enhanced SCTE 104	Click to enable enhanced SCTE 104 on the output server. This will disable <b>SCTE 104 Signal</b> , if already enabled.
SCTE 104 Event Mask	Enter a (decimal value) to be used for event masks. This can be used to perform partial or full replacement of splice_event_Id Inbound SCTE messages. The mask configuration allows for bit level “OR” masking. For example: <ul style="list-style-type: none"> <li>• Incoming message (hex): 0x00005c7e</li> <li>• Inputted Event Mask string (dec): 1073741824</li> <li>• Actual Event Mask (hex): 0x40000000</li> <li>• Output (hex): 0x40005c7e</li> </ul>
SCTE 104 Output Line	Enter the VANC line number on which to output SCTE messages. If Pass-Through on Output Line is also enabled, incoming messages will be passed through on this output line number.
National Breaks	Enable national break commands.
Local Breaks	Enable local break commands.
Pass-Through Enable	Enable message pass-through.
Pass-Through on Output Line	Enable message pass-through on the VANC line number specified in SCTE 104 Output Line. For example, if SCTE 104 Output Line is set to VANC line 7 for SCTE insertion, messages received on VANC line 10 will be passed through on VANC line 7.

**National/Local Breaks**

The table below describes how the configuration of national and local breaks affects the messages that are output:

National break	Local break	Description
----------------	-------------	-------------

National break	Local break	Description
✘	✘	iTX will trigger in all cases, i.e. when it receives Multiple Operation Messages with: <ul style="list-style-type: none"> <li>• Only a <code>splice_request_data</code> command</li> <li>• Both a <code>splice_request_data</code> and a <code>segmentation_descriptor_request</code> (for either local or national breaks).</li> </ul>
✔	✘	iTX will only trigger if a Multiple Operation Message is received with a <code>splice_request_data</code> and a <code>segmentation_descriptor_request</code> with the <code>segmentation_type_id</code> set to <code>National</code> (value <code>0x32</code> ).
✘	✔	iTX will only trigger if a Multiple Operation Message is received with a <code>splice_request_data</code> and a <code>segmentation_descriptor_request</code> with the <code>segmentation_type_id</code> set to <code>Local</code> (value <code>0x30</code> ).
✔	✔	iTX will only trigger if a Multiple Operation Message is received with a <code>splice_request_data</code> and a <code>segmentation_descriptor_request</code> with the <code>segmentation_type_id</code> set to <code>Local</code> (value <code>0x30</code> ) or <code>National</code> (value <code>0x32</code> ).

### Suppressing SCTE 104 triggers on slave channels

By default slave/back-up channels do not roll sequences configured to be triggered by SCTE signals. This behaviour can be disabled by clicking the **Suppress SCTE 104 Triggers on Slave** button.

## Dolby Digital settings

The right half of the dialog displays the settings for Dolby Digital audio:



For an AC-3 output that is generated from PCM sources, you can set the bit rate and other properties (dialog level and line/RF profile).

You select the format of the audio content that the Output Server plays out in the Audio Mapping configuration panel. [More details](#), page 152.

## Using the Configure Alerts dialog

Clicking **Configure Alerts** under the Channel Config 4 tab causes the Configure Alerts dialog to appear:



The dialog displays a list of alerts for which you can set threshold values and severity levels. A threshold value determines how far the Alerts Service allows a certain condition to develop before it issues an alert. The severity level indicates how seriously the condition is likely to affect schedule payout and other main iTX operations.

Clicking the entry for an alert in the Configure Alerts dialog causes the Alert Property dialog to appear.

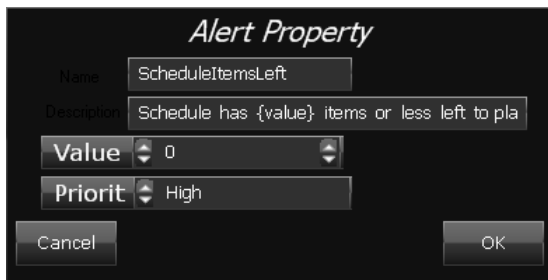

Through this dialog, you can:

- In the **Description** box, change the description for the alert.
- In the **Value** box, enter a threshold value.
- In the **Priority** box, set the severity level.



## Using the Advanced Aspect Ratio Control – Mapping Configuration dialog

Clicking **Configure Mapping** in the Advanced Aspect Ratio Control panel, under the Channel Config 4 tab, causes iTX to display a mapping dialog for the internal Advanced ARC (Aspect Ratio Control) and AFD-insertion features:

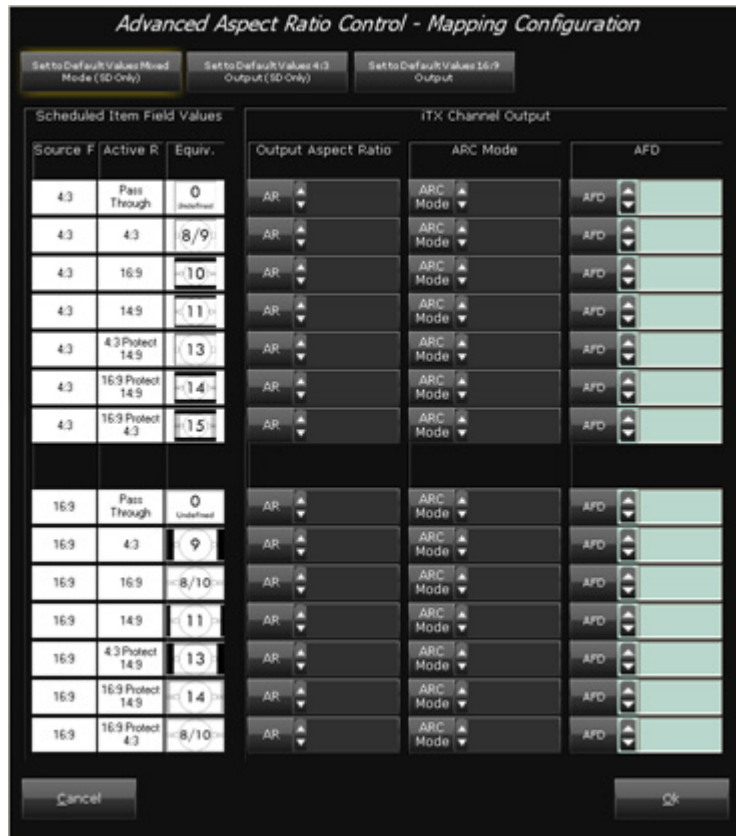

This dialog displays the settings for a range of Advanced ARC operations; it also displays settings for the AFD (Active Format Description) codes that may be inserted in the output video signal for these operations.

The ARC mode and AFD code for a schedule event are based on the source format (aspect ratio) and active region (the area of the video frame that contains the image) of the video clip that is used in the event.

You can set the ARC behaviour for different combinations of source format and active region by configuring the following.

- The aspect ratio of the output video frame. For HD channels, this is normally 16:9; for SD channels, 4:3.
- The ARC mode, which determines the type of ARC operation that will be performed on video clips with the specified combination of properties. The ARC can be disabled by setting the source video to play "full frame".

Also, depending on the type of ARC operation, you can set the AFD code.

To simplify configuration, three default mapping configurations are available; these should cover the requirements of most iTX systems. You may need to make minor adjustments to a default configuration for your system (for example, you may disable the ARC feature when the active region is set to "Passthrough").

**Note:**

- The Advanced ARC and AFD-insertion features are only available if your system has the necessary software License. Your system may be licensed to use the functionality for both of these in one licence. Configuring the settings for unlicensed functionality does not affect the output video signal.
- The mapping configuration dialog is intended to provide the maximum flexibility for the setting up of ARC operations and AFD insertion. The dialog does not prevent you from setting unsuitable configurations (for example, selecting a 4:3 aspect ratio for an HD channel).

To prevent problems with the display of the video image, ensure the configuration settings are correct for each channel in your iTX system.

## Set the mapping configuration

Do the following for each combination of source format and active region.

1. Select the aspect ratio of the output video in the **AR** box.
2. Select an ARC mode in the **ARC Mode** box. (You may disable the ARC feature by selecting "Disabled".)

For more information, see "[Available ARC modes](#)", page 165.

3. In the **AFD** box, select the AFD code to be inserted into the output video.

**Note:** iTX supports AFD codes 1000 to 1111 (8 to 15). You should not select AFD code 1100 (12); it is reserved for future use in the AFD standard.

4. Click **OK** to close the mapping dialog.
5. On the Channel Config dialog, click **Save**.

## Use a default mapping configuration

1. Do one of the following to select a default mapping configuration.
  - Click **Set to Default Values Mixed Mode (SD Only)** for an SD channel that uses both the 4:3 and 16:9 aspect ratios for its output video.
  - Click **Set to Default Values 4:3 Output (SD Only)** for an SD channel that uses the 4:3 aspect ratio for its output video.
  - Click **Set to Default Values 16:9 Output** for a channel that uses the 16:9 aspect ratio for its output video.

The selected configuration is applied to the Mapping Configuration dialog.

2. Change any of the mapping configurations, if you want to.
3. Click **OK** to close the mapping dialog.
4. On the Channel Config dialog, click **Save**.

## Available ARC modes

### 4:3 Output Aspect Ratio



### 16:9 Output Aspect Ratio

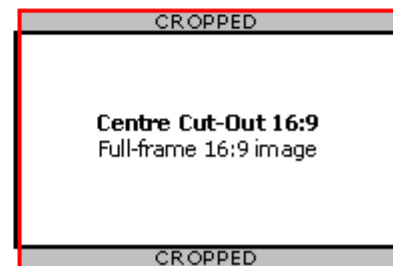
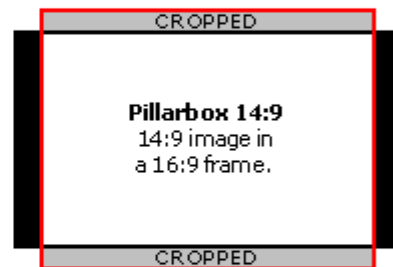
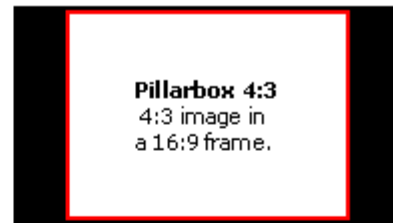

- Source Video Frame
- Output Video Frame

### Note:

- If you are operating an Output Server 2 channel, it is possible to create custom ARC modes from within the Advanced Aspect Ratio Control – Mapping Configuration dialog. For more information, see the *Output Server 2 Channel Configuration Guide*.

## Media Keep List – for playout channels

The Media Cache Service on an Output Server machine maintains a cache of media files based on schedule requirements. It deletes these files, when they are no longer needed, to allow new media files to be cached.

There may be some media files, such as channel logos, that you want the Media Cache Service to always keep in the cache. The service holds a list of these files and caches them before it caches other media files. We call the list the Media Keep List.

The list has two parts. One part has details of media files you manually add to the list. The other part has details of media files iTX automatically adds to the list – these are the ones you specify in the channel configuration (e.g. an off-air slide).

Both parts of the list are displayed in separate panes under the Media Keep List tab:



- The upper pane shows the manual part of the Media Keep List; i.e. details of the files you add to the list.
- The lower pane shows the files iTX adds to the list.

You can modify the list in the upper pane by adding or deleting files.

Where you want to use the same list for more than one channel, you can export a copy (of the manual part of the list) from one channel and import it into another. Exporting creates a Keep List file in the XML format.

### Manage the Media Keep List

1. Do the following for any media file you want to add to the Media Keep List.
  - Click **Add** to open the PinPoint dialog.
  - Use PinPoint to select one or more media files.
  - Click **OK** to close the PinPoint dialog.

The selected media files appear in the upper pane.

2. Do the following for any media file you want to delete from the Media Keep List.
  - Select one or more files in the upper pane.
  - Click **Remove**.

iTX removes the media files from the upper pane.

3. Do the following if you want to add a brief explanation of why a media file is in the Media Keep List.
  - Select a file in the upper pane.
  - Click **Set Reason** to open the Enter Reason dialog.
  - Enter a reason in the **Reason** box.
  - Click **OK** to close the Enter Reason dialog.

## Export a Media Keep List

You can export the manual part (the media-file details in the upper pane) of the Media Keep List.

1. Click **Export**.

The Export Keep List To XML File dialog appears.
2. Do the following.
  - Select a folder in which to store the XML file.
  - Enter a file name in the **File Name** box.
  - Click **Save**.

iTX creates a Keep List file.

## Import a Media Keep List

You can add files to the manual part of the Media Keep List by importing the Keep List file from another channel.

1. Click **Import**.

The Import Keep List From XML File dialog appears.
2. Do the following.
  - Navigate to the Keep List file you want to import.
  - Double-click the file; or select the file and click **Open**.

iTX imports the contents of the file; it adds the media-file details to the list in the upper pane.

## The Cache Settings tab – cache channels

**Note:**

- If your playout server is operating v2.6 Output Server 2 or later, the Cache Settings tab can be found on the Configuration panel of the Media Cache 2 user interface.

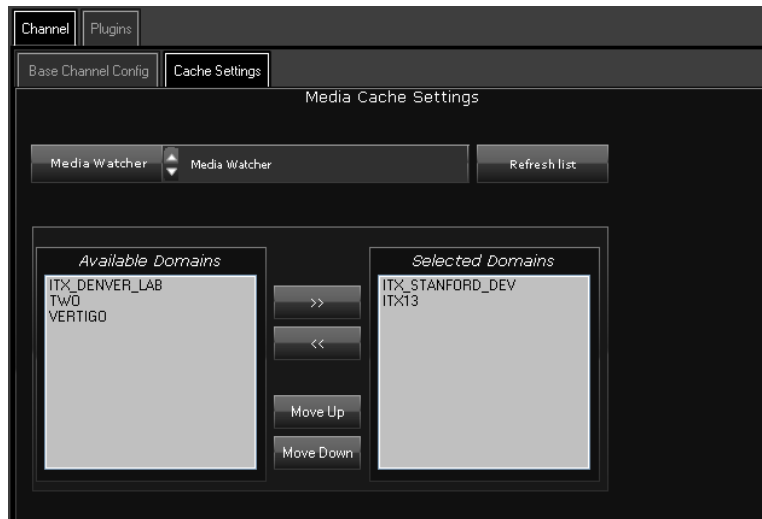

### Media Watcher

In the **Media Watcher** box, you select the Media Watcher that is to copy files from external search folders when they are required for playout. Depending on the search-folder configuration, the copy destination may be either the Output Server cache or a Media Store managed by the Media Watcher.

### Search-domains panel

Through the search-domains panel, you may set up a Media Cache Service to use its own search domains list instead of the central list that you configure in the Media Watcher. [More details](#), page 91.

The panel is similar to the one under the Domains tab of the Media Watcher user interface. It has an extra button:



You use this button to switch the service between using the local configuration and the central one.

**Note:**

- If you set up the Media Cache Service to use a local domain search list, you must set up TXPlay on the same machine to use an identical list.

## The Scheduled Booking Config tab – scheduled-ingest channel

This tab is relevant to systems that include Ingest Manager, an iTX application for managing scheduled recordings. It appears when you select the channel of the Ingest Control Service.

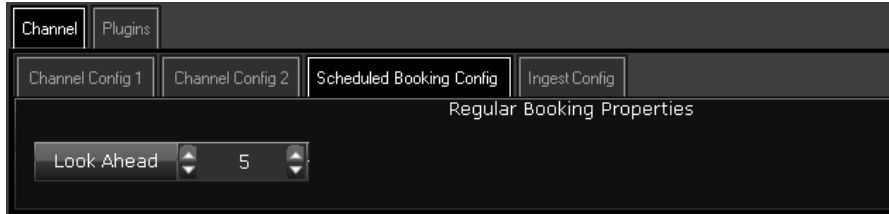

### Look Ahead

Each time Ingest Manager scans the entries in the Scheduled Booking List, it notes what recordings are due to occur within the immediate future period known as its look-ahead period.

The look-ahead period is a property of the Ingest Control Service channel. You specify the length of it (in hours) in the **Look Ahead** box.

## The Ingest Config tab – scheduled-ingest channel

This tab is relevant to systems that include Ingest Manager, an iTX application for managing scheduled recordings. It appears when you select the channel of the Ingest Control Service.

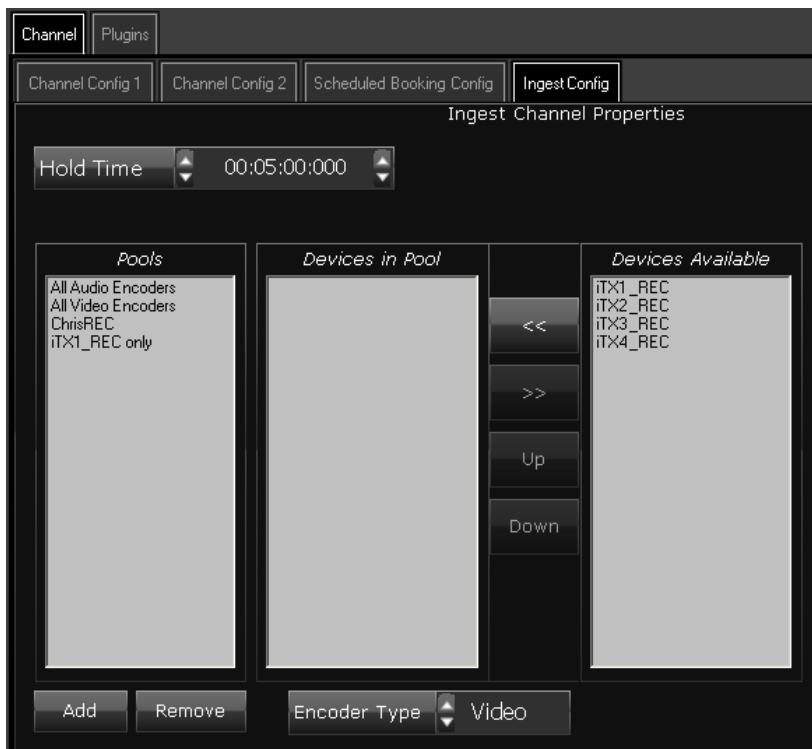

## Hold Time

In the **Hold Time** box, you can set the length of time for which iTX continues to hold recording events in the Schedule Grid (on the Ingest Manager layout) after they have happened. An operator can choose to show or hide these events, which we call history events. The displayed time value is in the timecode format for the channel.

## Creating device pools

An operator selects a device pool when requesting Ingest Manager to perform a recording. A device pool is a group of Encode Servers from which Ingest Manager selects one to use for the recording – it selects the first available one it finds.

You create and edit device pools using the panes under the Ingest Config tab:

- The Pools pane displays a list of existing device pools.
- The Devices In Pool pane shows what devices belong to a pool selected in the Pools pane.
- The Devices Available pane lists all the video or audio Encode Servers in the system.

You may create different device pools for different types of ingest job. For instance, you may create one device pool for recording a regular feed from a news agency; another, for ingesting a live sports feed.

Do the following to create a device pool.

1. Click **Add**.

The Add New Device Pool dialog appears.

2. Enter a name for the new device pool in the **Name** box; click **OK** to close the dialog.

An entry for the new device pool appears in the Pools pane.

3. In the **Encoder Type** box, select the type of Encode Server you want to include in the device pool: video or audio.
4. Ensure the new device pool is selected in the Pools pane.

5. Select Encode Servers in the Devices Available pane and click  to copy them to the Devices In Pool pane. Use the **Up** and **Down** buttons to arrange the Encode Servers in the order in which you want Ingest Manager to check their availability.

You may remove any selected Encode Server from the device pool by clicking .

6. Click **Save**.

### Note:

- You may delete a device pool by selecting it in the Pools pane and clicking **Remove**.

## Using a spreadsheet to set properties for a group of playout channels

In an iTX system with multiple playout channels, you can manually set the properties of each channel through the Channel Configuration pop-up layout. But you may find it more convenient



to use the Microsoft Excel spreadsheet, "iTX Channel Config Master.xls", which is in the installation folder (iTX Suite). The path to the file is:

```
..\iTX Suite x.xx\iTX Install\Utilities\iTX Channel Config Master.xls
```

## Configure payout and edit channels by using a spreadsheet

1. Open the spreadsheet "iTX Channel Config Master.xls".
2. Do the following for each channel you want to configure.
  - On a new row, enter the channel name in the ServiceName column.
  - In the pre-defined columns, enter the required information and select options from the dropdown lists for the various channel properties.
  - In the Reset column, select "Yes" if you want iTX to restart the Output Server after the configuration. A restart is necessary if you change a video or audio format.
3. Save the spreadsheet as a CSV (comma-delimited) file.
4. Place the CSV file in the Inbox on the Media Store.

The Media Watcher copies the configuration details into the System Database. iTX then applies the configuration.

### Note:

- You configure the channel plug-ins under the plug-in tabs on the Channel Configuration pop-up layout. [More details](#), page 172.
- You may remove columns and rows from the spreadsheet if they relate to settings that you do not want to change.
- You can update the channel properties in the spreadsheet. After you place the file in the Inbox, the Media Watcher copies the updated configuration details into the System Database. iTX then applies the updated configuration.

## Configuring channel plug-ins

A channel plug-in is a software component that iTX uses to handle a particular type of schedule event. There are separate plug-ins for different types of asset (video clip, CG, logo, etc.). Plug-ins provide the palettes that appear in the Content Selector on the Channel Control layout.

You configure plug-ins under the Plugins tab on the Channel Configuration pop-up layout:



There are separate sub-tabs for the plug-ins that are installed and licensed in your iTX system. In this section we describe the features that appear under these tabs:

- Schedule
- Ex Subtitler
- GPI
- VANC
- Clarity
- Viz RT
- Vertigo XG
- Live
- Studio
- Video Clip
- Colossus
- Route
- Data
- Scheduled Ingest
- Logo
- SCTE 104

## Modifying the properties of channel plug-ins

### Select a channel for configuration

You need to select a channel before you can change its configuration.

To do so, you use the View Selector to select any view that includes the channel; you then select the channel in the Channel Selector.

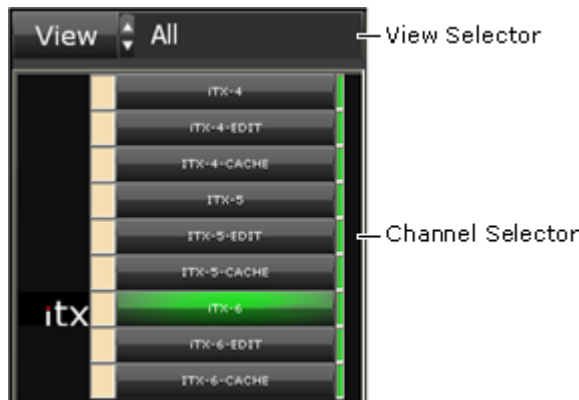

The text box in the Common Channel Configuration panel shows the channel name:



### Set channel plug-in properties

1. Select a channel.
2. Use the features under the Plugins tab to set the new properties. [More details](#), page 172.

The **Save** button flashes green to indicate there are unsaved changes.

3. Click **Save**.

iTX updates the channel properties. The **Save** button stops flashing.

**Note:**

- You can cancel any unsaved change by clicking **Cancel** instead of **Save**.
- You can restore the default settings by clicking **Default**.

### The Schedule Event Configuration panel

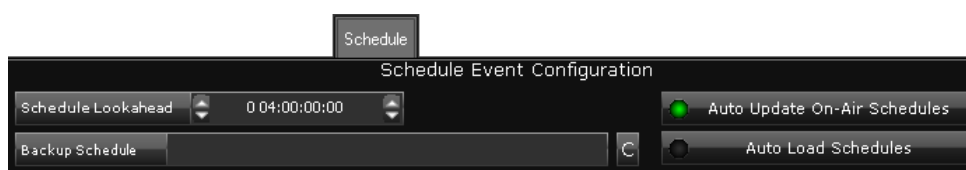

The Schedule Event Configuration panel has features that enable you to do the following.

- Set a schedule look-ahead time for nested schedules in a live schedule.
- Specify a back-up schedule for iTX to use in place of a missing schedule.
- Set up iTX to automatically load specially labelled schedules on specified dates.

When an operator adds a saved schedule to an existing schedule, by using the Content Selector on the Channel Control layout, the schedule becomes nested inside the main schedule. iTX first displays a single entry for the nested schedule in the Schedule Grid.

As the start time for the nested schedule approaches, iTX adds the schedule contents to the entry and displays a plus sign in front of it. Clicking the plus sign expands the entry to show the events in the nested schedule.

The entry becomes expandable at a time that is a specified interval before the start of the nested schedule. You specify the length of the interval – known as the look-ahead time – in the **Schedule Lookahead** box.

If the nested schedule is updated and re-imported through the Inbox after it becomes expandable, iTX can automatically update the schedule entry in the Schedule Grid. On doing so, it re-loads all schedule events that come after the on-air event; or all schedule events that come after the schedule lockout period, if you set one. [More details](#), page 142.

If you want iTX to perform this automatic updating, you should select **Auto Update On-Air Schedules**. If you do not want iTX to do this, you should ensure the option is not selected.

If a schedule is not available for playout within an hour of the schedule start time, iTX can replace the schedule entry in the Schedule Grid with a back-up schedule.

To specify a back-up schedule, click **Backup Schedule** to open PinPoint (the iTX search tool); use PinPoint to select a replacement schedule. Clicking **C** (to the right of the Backup Schedule entry) clears the selected schedule. If you do not want iTX to perform automatic schedule replacement, you need to ensure there is no entry in the **Backup Schedule** box.

In the Schedule Manager on the Channel Control layout, an operator can save a schedule in a format with date and channel labels (for example, 2009-7-31 - iTX1). For any given channel, one schedule for each day can be saved in this way. When there is a schedule saved in this format for the current day, iTX can automatically add the events from the schedule to the Schedule Grid.

If you want iTX to automatically load a schedule into a channel, you need to select **Auto Load Schedules** (the button indicator displays a green light). If you do not want iTX to do this, you need to ensure the option is not selected.

## The External Subtitler Configuration panel

You set up iTX to work with an external subtitler in the External Subtitler Configuration panel:



You select the communications protocol for the external subtitle in the **Available Protocols** box; the protocol name appears in the text box at the top of the panel.

You enter the i.p. address of the subtitle in the **Location** box. For a Polistream system, the entry should be the short name of the Polistream Channel Server (which you can check in the Polistream Config Client tool).

In the **Port** box, you enter the number of the port used for communications between iTX and the subtitling system. For a Polistream system, the required number is the one that the Polistream Name Exporter uses when communicating with the Name Maintainer on the Output Server; Screen Subtitling Systems Ltd provide this number. For Cavena, the port number is 4703.

If the Cavena protocol has been selected, a Service ID number must be configured. This is a number that identifies the STC output to which the STU for the particular iTX channel is connected.

For a system that has main and back-up Output Server machines, two hardware configurations are possible:

- The master-slave pair of channels may share an external subtitle. For this configuration, you select **Shared Device**; only the main Output Server then controls the subtitle.
- The master and slave channels may have separate subtitles. You then need to ensure **Shared Device** is not selected; each Output Server controls its own subtitle, with the main output being routed into the transmission path.

**Note:**

- An external subtitle requires timecode to be present in the video signal it receives from the Output Server. If any video clips that iTX is to play out do not contain timecode, you need to set up iTX to generate it. [More details](#), page 181.
- For a Polistream system, the network should allow bi-directional UDP communications.

## The GPI Configuration panel

In the GPI Configuration panel, you set the actions that iTX performs when it receives GPI inputs.



In the **Matrix** box, you choose the matrix name of the GPI device that is to provide the GPI inputs; the box displays the name of the service controlling the device.

To set a GPI input for an action, you click the action button (e.g. **Take Next**) to display the Select Input dialog; through this dialog, you select the GPI input. When you close the dialog, the box displays the name of the selected GPI input.

**Note:**

- A GPI input for Take Next takes the next schedule event (the one following the current on-air event).

- A GPI input for Take Next Sequence takes the next sequence to air, but only if iTX receives the trigger within the sequence availability time.

## The VANC Configuration panel

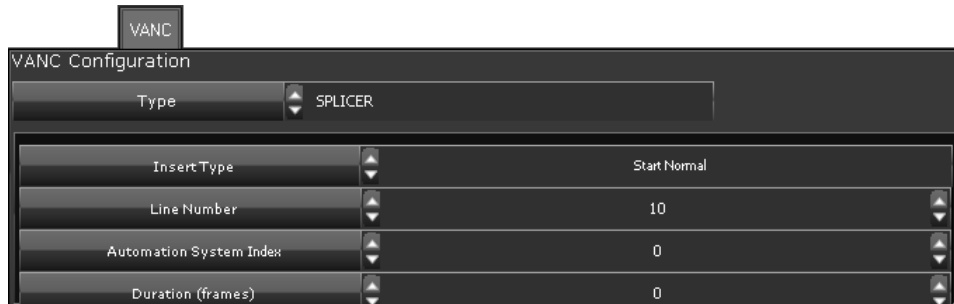

Through this panel, you set the properties for VANC (Vertical Ancillary) data in a live video signal. The available VANC message types depend on XML configuration files located in a folder on the Output Server machine. The default path to the folder is:  
 C:\Program Files (x86)\iTX2.0\Services\TXPlay

After you select a message type in the **Type** box, the panel displays settings for properties associated with that type. The properties are defined in the configuration file for the message type.

For example, you set the following properties for a splicer message (used to trigger the insertion of media content, usually advertisements, into the channel output):

- In the **Insert Type** box, you select a splicer message type.
- In the **Line Number** box, you enter the number of the VANC line that carries the message.
- In the **Automation System Index** box, you enter the number (0-255) for the iTX automation system index, if you are using more than one automation system for SCTE 104 messages. If you are using one automation system, enter "0".
- In the **Duration (frames)** box, you enter the number of frames for the duration of the message.

## The Clarity Configuration panel

You set the properties for a Pixel Power Clarity character generator in the Clarity Configuration panel:

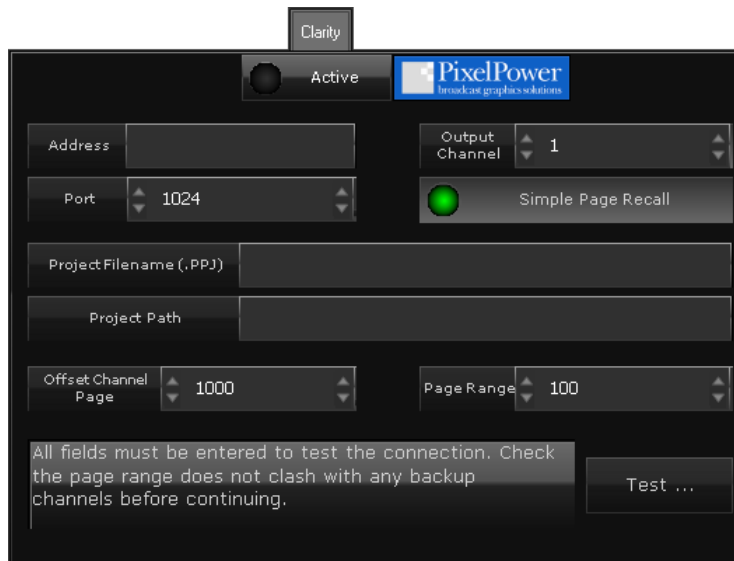

Select **Active** to use the Clarity character generator with the channel. This allows an operator to add a CG from a page in a Clarity character generator to a schedule.

You enter the IP address of the Clarity XML Socket Server in the **Address** box; and the port number for this device in the **Port** box (the default is 1024).

You select the channel number the Clarity character generator uses when sending a template page to iTX in the **Output Channel** box.

The setting of the **Simple Page Recall** button controls how iTX uses the Clarity pages:

- With the option selected, iTX plays out pages direct from the Clarity machine; operators cannot edit page content in iTX.
- With the option not selected, iTX copies pages from the Clarity machine and plays out the copies; operators can edit the page content on the iTX Desktop.

In the **Project Filename** box, you enter the name of the default project on the Clarity character generator. You enter the path of this project on the Clarity character generator in the **Project Path** box.

When template pages are available in the project, the operator can select a page in the Clarity palette of the Content Selector on the Channel Control layout; the page can then be used in schedule events.

In the **Offset Channel Page**, you select the number of the page on which you want the Clarity character generator to generate the image before it is sent to the output channel. In the **Page Range** box, you select the page range the character generator uses.

To test the Clarity character generator configuration, you click **Test**. The test results are displayed in the Clarity Test Report dialog. When the test is finished, click **Close** to close the dialog.

## Configuring Clarity for Main/Backup Setups

If you are operating a main/backup (also known as master/slave) setup with a Clarity character generator, the on-air channel controls the Clarity. Therefore, you must route the channel destination to the Clarity's input and the Clarity Configuration Plugin must have the same configuration on both the main and backup channels.

## The VizRT Graphic Configuration panel

You set up iTX to work with a VizRT character generator through the VizRT Graphic Configuration panel:

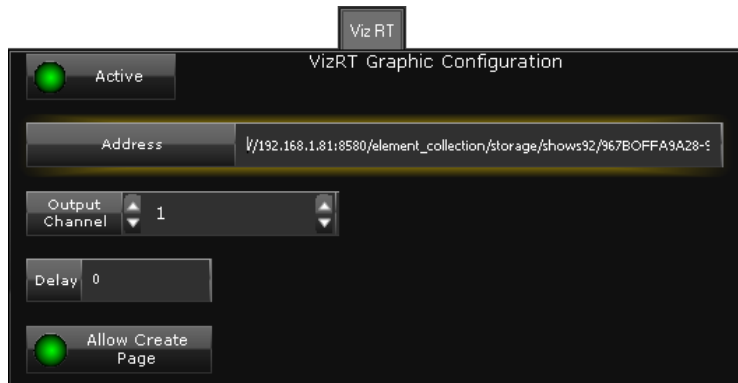

Select **Active** to use the VizRT character generator with the channel. This allows an operator to create a CG event using a page in the VizRT character generator.

In the **Address** box, enter the address of the VizRT device. This typically consists of a number of elements:

- The IP address of the VizRT device and the port number that it uses for communications with iTX.
- The path of the directory that stores the pages that are to be available for VizRT events.
- The name of template that may be used for creating pages that do not exist.

To allow the VizRT device to create pages that do not exist, you select **Allow Create Page**.

The **Output Channel** and **Delay** boxes are not currently used.

## The VertigoXG panel

The branding capabilities of a typical iTX playout channel can be enhanced by integrating Vertigo graphics events into the iTX playout schedule. Using the VertigoXG plugin, Vertigo XG events can be added to the iTX Desktop's schedule as secondary graphics events and then inserted into the iTX program stream either using:

- the XG Inside as an option that integrates the XG Renderer directly within iTX Output Servers and iTX Playout Appliances

or,

- an external Grass Valley Vertigo XG device downstream of the iTX Output Server.

For more information about configuring Vertigo XG, see the *Vertigo XG & iTX Integration User Guide*.

## The Live Event Configuration panel

In a live event, iTX receives a live feed from a router source and switches this into the channel output instead of playing out a file through the iTX Player. The Output Server machine is connected as a destination on a matrix router; one or more live feeds are connected as sources.



The router sources of available live feeds are specified in assets – called live events – in the System Database. You specify the router destination of the Output Server in the Live Event Configuration panel:



To do so, you select the matrix router in the **Matrix** box and the destination in the **Destination** box.

**Note:**

- If you are operating Output Server 2, the Matrix and Destination fields are not located within iTX Desktop, but are instead part of the user interface for the I/O Device Controller service. For more information see the *iTX Output Server 2 Channel Configuration Guide*.

You set a default duration for the live events in the **Default Duration** box; iTX assigns this duration to live events that are added to the Content Selector on the Channel Control layout; an operator may change this duration when adding live events to a schedule.

**Setting GPIs for live events**

You can set a GPI input and output for any live event that is to be available in the selected layout channel.

An example of when you may use a live event with GPI triggers is to enable an operator to end the live event by manually taking a commercial break to air from a hard panel. This functionality uses a GPI output to enable a Take button on the hard panel when the live event is playing out; also, a GPI input from the Take button to trigger the next sequence event, containing the commercials. The sequence event must be configured to accept external triggers.

In the Live Event Configuration panel, you create a list of live events and assign GPI inputs and/or outputs to them:

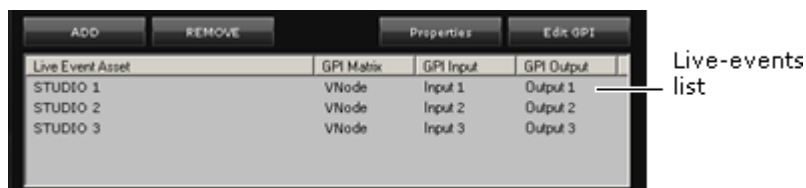

- To create the live-events list, you click the **Add** button to open the PinPoint dialog in the live-event searching mode. You use this to find live events and select ones to work with. When you close the dialog, the selected live events appear in the live-events list.

- You can remove any selected live event from the live-events list by clicking **Remove**.
- After selecting a live event in the live-events list, you can assign GPI triggers to it. To do so, you click **Edit GPI** to display the Edit GPI dialog. Through this dialog, you select the matrix name of the GPI device and then a GPI input and/or a GPI output.
- Through the Edit GPI dialog, you may set up iTX to introduce a delay between the operation of the Take button and the start of the sequence event. You specify the length of the delay in the **Take Delay** box.
- You can view the properties of any selected live event and their GPI after clicking **Properties** to display the Properties dialog.

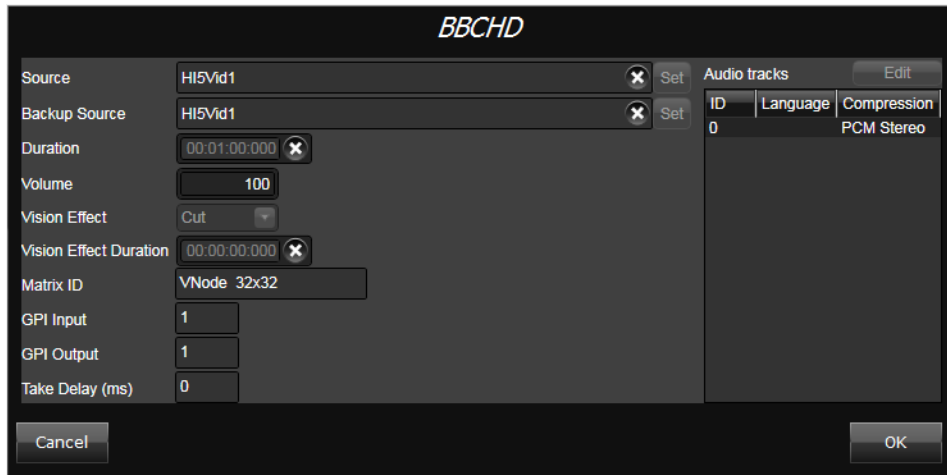

**Recording of live events**

During the installation of an Output Server module, you may set up the Output Server for the recording of live events.

Through the Event Editor on the Channel Control layout, an operator can make a request for iTX to record a selected live event. While playing out the event, iTX records it into a file on the Media Store; it creates a video clip for the file.

You configure the file content and properties by selecting options in the Record Live Events Profiles section of the Live Event Configuration panel:

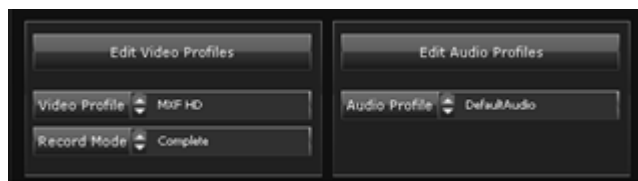

- For a video recording, you set the file properties by selecting an encoding profile in the **Video Profile** box.
- In the **Record Mode** box, you specify at which stage of the video-mixing process the recording takes place: Before all, if you want iTX to record just the video feed; Before Branding, if you want iTX to record the video feed and any VANC data it inserts; Complete, if you want iTX to record the video feed, VANC data, and any logos it overlays.
- For an audio recording, you set the file properties by selecting an encoding profile in the **Audio Profile** box.
- Clicking the **Edit Video Profiles** or **Edit Audio Profiles** displays the Encode Settings dialog for video or audio encoding. Through this dialog, you can edit, add or remove encoding

profiles. See the iTX Operator Manual for iTX v2 for instructions on how to perform these tasks.

## The Studio Setup panel

Where you are using a GPI device to generate GPI outputs to control broadcasting equipment, you configure the studio sources and the GPI outputs by using the Studio Setup panel:

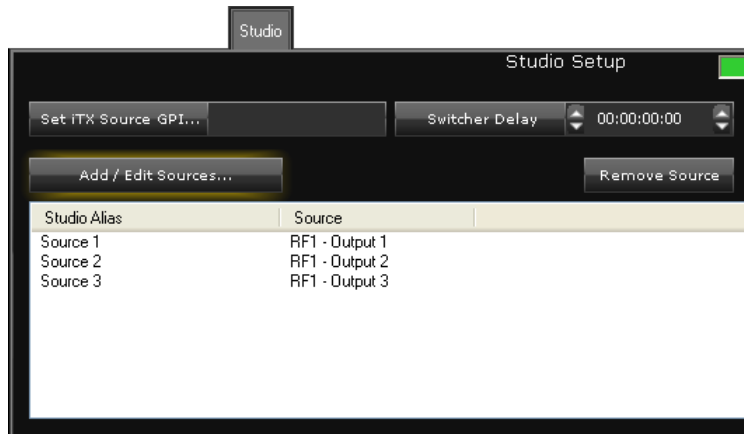

The panel displays a list of studio sources that are to be available for studio-source events.

- To create the studio source list, you click **Add/Edit Sources** to display the Add Source GPI dialog. Through this dialog, you select a GPI output from a GPI matrix; you also assign an alias to the GPI output. The selected GPI output appears in the source list.
- To edit a studio source, select it in the source list and click **Add/Edit Sources**. Change the properties of the source through the Add Source GPI dialog.
- In the **Switcher Delay** box, you specify the length of any delay that iTX should introduce between the studio-source event playing out and iTX sending the GPI output to the vision mixer.
- To remove a studio source, select it in the source list and click **Remove Source**.

iTX does not use the **Set iTX Source GPI** setting.

## The Video Clip Configuration panel

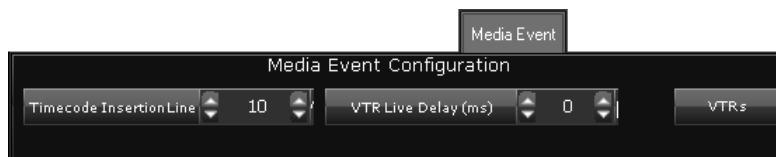

Through this panel, you specify where iTX is to insert a timecode track when it is needs to add one to the channel output signal. Timecode may be required for the operation of a downstream device (i.e. one that receives the output signal) such as a subtitle inserter.

When iTX generates timecode, it uses the timecode of the in-point of the video-clip it is playing out as a reference for all other frames in the clip; it adds the timecode on the line you specify in the **Timecode Insertion Line** box.

- The required line number for a HD channel is 10.
- If you do not want iTX to generate timecode, enter a value of 0.

In general, the setting is for video clips (such as those from an Omneon Spectrum video server) that do not contain a timecode track.

If a video clip already contains timecode on the specified line, iTX overwrites this. If it contains timecode on a different line, iTX simply adds a second timecode track on the specified line. You should ensure the number in the **Timecode Insertion Line** box matches the number of the line that the downstream device reads timecode from.

Through other features on the panel, you can set up iTX to play out VTR events; i.e. events featuring video clips that are on videotape.

- Using the **VTRs** button, you can specify which VTRs are to be available to the channel for playout.
- By entering a number in the **VTR Live Delay** box, you can cause iTX to delay playout of a video clip by that number of frames. Although the setting is normally zero, a small delay may be necessary for operational reasons.

Clicking **VTRs** displays a dialog with two panes: the Available pane has a list of all VTRs registered in the iTX system; the Selected pane shows which of these VTRs are available for playout. You may move VTRs to or from the Selected pane.

**Note:** VTRs are registered and controlled through the Device Manager service.

## The Schedule Import Configuration panel (Colossus tab)

iTX uses the Schedule Import plug-in(found on the Colossus tab) to import schedules in files from third-party traffic systems. The schedules must be in the format defined by the iTX Import Protocol; schedule files in this format have the filename extension ".osc".

For more information about the iTX Import Protocol, contact iTX Support.

An imported schedule may contain events that refer to generic logos (logo\_0 to logo\_7), CG templates or graphics-script templates. You need to map the logos and templates to media files on the Media Store so that iTX can play them out.

Similarly, an imported schedule may contain events that refer to generic GPI outputs (gpi\_0 to gpi\_7), which you need to map to the outputs of a GPI matrix in your iTX system.

You perform the mapping for these various items on the Schedule Import Configuration panel:



You set configuration options on a channel-by-channel basis; this means you can map different sets of logos, CGs, graphics scripts and GPI outputs for different channels.

**Note:**

- Schedules with a local timecode (due to an offset from UTC or daylight saving time) must be converted to UTC before they are imported.

**Map a generic logo to a logo file**

In a schedule that is in the format defined by the iTX Import Protocol, logo events may feature generic logos "logo\_0", "logo\_1", and so on – up to "logo\_7". To enable iTX to play out such events, you need to map the generic logos to logo files in the iTX system.

After selecting a playout channel, perform this procedure for each generic logo that appears in imported schedules.

1. Select a generic logo in the **Logo** box.

For example, select "Logo:3" for the generic logo in this schedule entry:

```
ITEM
clip Football Highlights
logo_3 1
...
end
```

2. Do the following to select a logo file in the iTX system.

- Click the preview pane to open the Live Logo Setup dialog.



- Click **Select** to open PinPoint.

- Use PinPoint to select a logo.

The logo appears in the Live Logo Setup dialog when you close PinPoint.

3. Set default properties for the logo, if you want to. See below, "Set default playout properties for a mapped logo".
4. Click **OK** to close the Live Logo Setup dialog.

When you close the Live Logo Setup dialog, the **Save** button on the Channel Configuration pop-up layout flashes; this is to show there are unsaved changes.

5. Click **Save** to save the logo mapping.

iTX associates the generic logo with the logo file.

**Note:**

- An imported schedule can include a logo filename that overwrites the logo mapping. For more information about this functionality, see the document for the iTX Import Protocol; you can download this from the Club iTX website.

**Map a generic logo to an external logo**

To map a generic logo to an external logo, you need to select **External** and enter the path and name of the logo in the associated text box:



**Set default playout properties for a mapped logo**

You can assign default playout properties to a mapped logo; for example, its in- and out-transitions.

1. Do the following, if necessary, to display the mapped logo in the Live Logo Setup dialog.
  - Select the logo in the **Logo** box.
  - Click the logo preview pane to open the Live Logo Setup dialog with the logo loaded.
2. Do the following to set the physical properties of the logo.
  - Click the logo in the Live Logo Setup dialog or click **Logo Edit**. The Logo Editor opens and displays the logo.
  - To re-position the logo, drag it into the new position; or enter values in the **X** and **Y** boxes.
  - To resize the logo, keeping the same proportions, ensure **Lock Aspect** is selected. Drag any edge of the logo; or enter values in the **W** and **H** boxes.
  - To resize the logo, changing its height and width independently, ensure **Lock Aspect** is not selected. Drag any edge of the logo; or enter values in the **W** and **H** boxes.
  - Click **Full Screen** if you want the logo to fill the display area.

3. To adjust the logo transparency, click **Options** to display the Logo Options dialog. Adjust the **Key Level** slider.  
 You may set vision effects for the logo in the Logo Options dialog, before clicking **OK** to close the dialog. Or, you may set them in the configuration panel (as described below).
4. Click **OK** first to close the Logo Editor; then again to close the Live Logo Setup dialog.  
 You may click **Save** to save your changes at this stage.
5. In the configuration panel, do one of the following to assign a logo type and set the timing.
  - Click **Permanent** if you want iTX to permanently display the logo, starting at an offset from the start of an associated primary event. In the **Offset** box, enter the value of the offset.
  - Click **Clip Dur** if you want iTX to display the logo while a primary event plays; the logo switches on at an offset from the start of the primary event and switches off at an equal offset from the end. In the **Offset** box, enter the value of the offset.
  - Click **Plus** if you want iTX to display the logo for a specified duration, starting at an offset from the start of a primary event. In the **Offset** box, enter the value of the offset; in the **Dur** box, enter a value for the duration.
  - Click **Minus** if you want iTX to display the logo for a specified duration, starting at an offset from the end of a primary event. In the **Offset** box, enter the value of the offset; in the **Dur** box, enter a value for the duration.

6. Click **In**, to select the in-point settings:

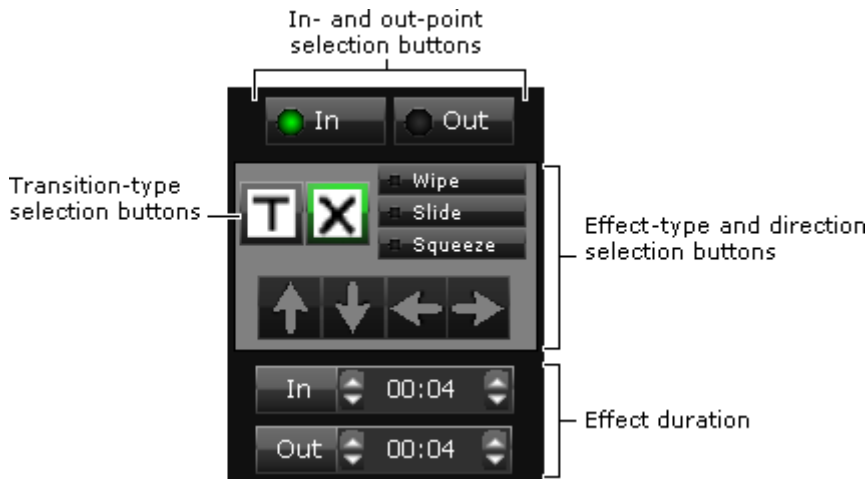

Then do one of the following to set the vision effect for the logo in-point.

- Click a transition-type selection button, for a cut or cross-fade transition.
  - Click **Wipe**, **Slide** or **Squeeze** to select a type of effect; click one of the arrow buttons to select the direction; enter a value in the **In** box to set the duration of the effect.
7. Click **Out**, to select the out-point settings. Repeat the previous step (but specify a duration in the **Out** box for any effect you select) to set the vision effect for the logo out-point.
  8. Click **Save**.

iTX updates the logo properties.

## Map a CG template to a CG file

In a schedule that is in the format defined by the iTX Import Protocol, CG events may feature CG templates. To enable iTX to play out such events, you need to map the templates to CG files in the iTX system.

After selecting a playout channel, perform this procedure for each CG template that appears in imported schedules.

1. Select **CG** on the Schedule Import Configuration panel.
2. Click **Create**.

iTX opens the Enter Template Name/Number dialog.

3. In the **Name** box, enter the name or number of a CG template as it appears in imported schedules.

For example, enter "News Crawl" for the CG template in this schedule entry:

```
ITEM
clip CAPTION
data News Crawl|With:Mike Barker|
...
end
```

4. Click **OK** to close the dialog.
5. Use PinPoint to select a CG file from the iTX System Database.

When you close PinPoint, iTX displays the template name or number in the **Template** box and the name of the CG file in the **CG Page** box.

The **Save** button flashes; this is to show there are unsaved changes.

6. Click **Save** to save the CG mapping.

iTX associates the CG template with the CG file.

## Set default playout properties for a CG template

You can assign default playout properties to a mapped CG template; for example, its in- and out-transitions.

1. Select **CG** on the Schedule Import Configuration panel.
2. Select a mapped CG in the **Template** box.
3. Click **In**, to select the in-point settings:



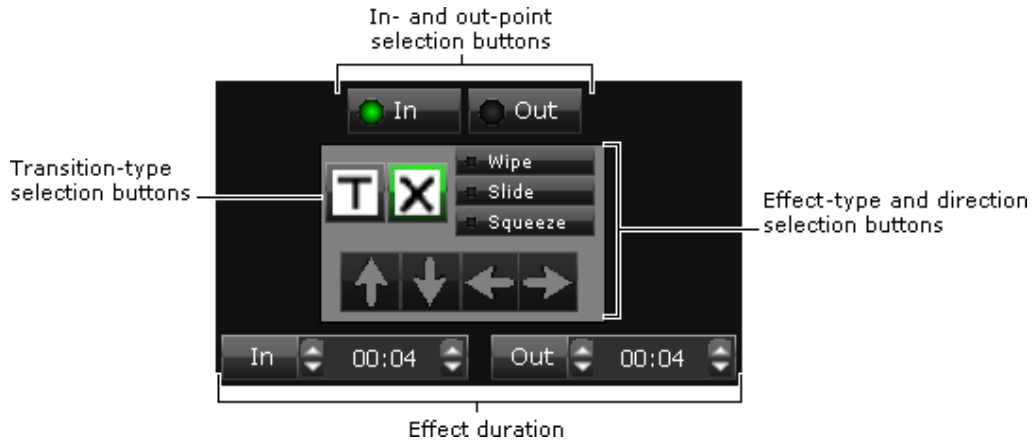

Then do one of the following to set the vision effect for the template in-point.

- Click a transition-type selection button, for a cut or cross-fade transition.
  - Click **Wipe**, **Slide** or **Squeeze** to select a type of effect; click one of the arrow buttons to select the direction; enter a value in the **In** box to set the duration of the effect.
4. Click **Out**, to select the out-point settings. Then repeat the previous step (but specify a duration in the **Out** box for any effect you select) to set the vision effect for the CG out-point.
  5. Click **Save**.

iTX updates the CG template properties.

### Overriding a CG template mapping

It is possible to override the CG template mapping, so that the original template animation settings will not get overridden by settings in the Schedule Import Configuration panel.

To override the CG template mapping:

1. Click **CG Page** on the Schedule Import Configuration panel.  
iTX opens PinPoint, the iTX search tool.
2. Use PinPoint to select a CG file from the iTX System Database.  
When you close PinPoint, iTX clears the contents the **Template** box and the name of the new CG file will be displayed in the **CG Page** box.  
The **Save** button flashes; this is to show there are unsaved changes.
3. Click **Save** to save the settings.  
iTX will now use the animation settings of the selected CG file, rather than the settings in the Colossus plugin.

### Map a graphics-script template to a graphics script

In a schedule that is in the format defined by the iTX Import Protocol, graphics events may feature graphics-script templates. To enable iTX to play out such events, you need to map the templates to graphics scripts in the iTX system.

After selecting a playout channel, perform this procedure for each graphics-script template that appears in imported schedules.

1. Select **GFX** on the Schedule Import Configuration panel.
  2. Click **Create**.
- iTX opens the Enter Template Name/Number dialog.
3. In the **Name** box, enter the name or number of the graphics-script template as it appears in imported schedules.

For example, enter "Breaking News" for the graphics script in this schedule entry:

```
ITEM
clip GFX
data Breaking News|1:Live Report|
...
end
```

4. Click **OK** to close the dialog.
- iTX opens PinPoint, the iTX search tool.
5. Use PinPoint to select a graphics script from the iTX System Database.
- When you close PinPoint, iTX displays the template name or number in the **Template** box and the name of the graphics-script in the **CG Page** box.
- The **Save** button flashes; this is to show there are unsaved changes.
6. Click **Save** to save the graphics-script mapping.
- iTX associates the graphics-script template with the graphics script.

### Set default layout properties for a graphics-script template

You can assign default properties to a mapped graphics-script template; for example, its in- and out-transitions.

1. Select **GFX** on the Schedule Import Configuration panel.
2. Select a mapped graphics-script template in the **Template** box.
3. Click **In**, to select the in-point settings:

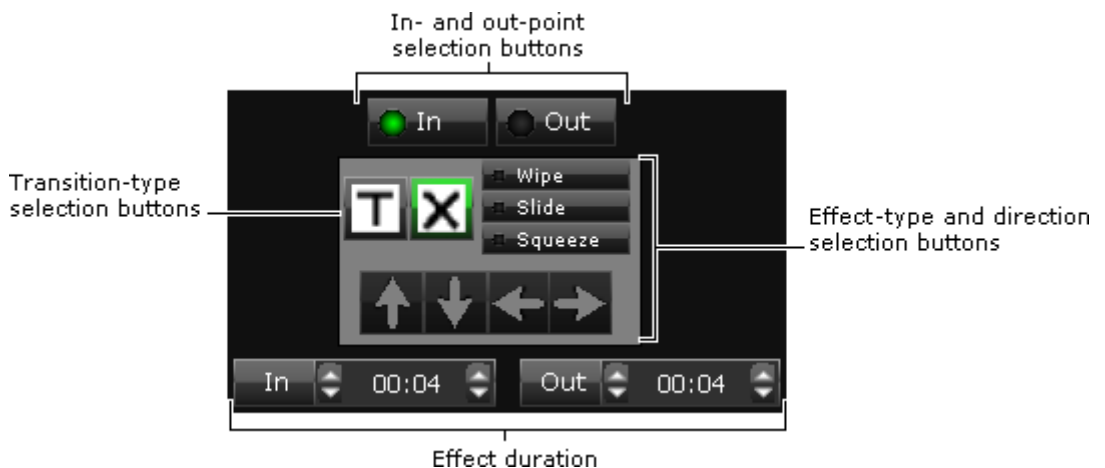

Then do one of the following to set the vision effect for the template in-point.

- Click a transition-type selection button, for a cut or cross-fade transition.
- Click **Wipe**, **Slide** or **Squeeze** to select a type of effect; click one of the arrow buttons to select the direction; enter a value in the **In** box to set the duration of the effect.

- Click **Out**, to select the out-point settings. Then repeat the previous step (but specify a duration in the **Out** box for any effect you select) to set the vision effect for the graphics-script out-point.
- Click **Save**.  
iTX updates the graphics-script template properties.

### Delete all mappings for CG and graphics-script templates

- On the Schedule Import Configuration panel, click **Delete All**.
- Click **Save**.  
iTX removes all mapped CG and graphics-script templates from the Schedule Import Configuration panel.

### Map a generic GPI output to an output on a GPI matrix

In a schedule that is in the format defined by the iTX Import Protocol, GPI events may feature generic GPI outputs "gpi\_0", "gpi\_1", and so on – up to "gpi\_7". To enable iTX to play out such events, you need to map the generic GPI outputs to outputs on a GPI matrix in the iTX system.

After selecting a playout channel, perform this procedure for each generic GPI output that appears in imported schedules.

- Select a matrix in the **GPI Matrix** box.
- Enter the number (between 0 and 7) of a generic GPI output in the **GPI** box.

For example, enter 3 for the generic GPI output in this schedule entry:

```
ITEM
clip Football Highlights
gpi_3 1
...
end
```

- Select an output on the GPI matrix in the **Output** box.
- Click **Save**.  
iTX associates the generic GPI output with the output on the GPI matrix.

#### Note:

- You may set a duration for a GPI output by selecting **Dur** and entering a value in the **Duration** box.

### The Route Event Configuration panel

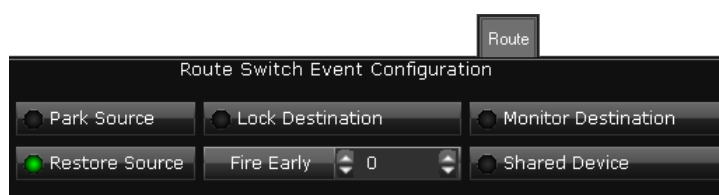

In the Route Switch Event Configuration panel, you set options for the control of scheduled routing events.

In an iTX system that has main and back-up playout channels, you need to prevent iTX sending commands from both channels to switch a router. To do so, you select **Shared Device** for each channel. iTX then controls the router through the main channel.

Depending on the properties of a routing system (e.g. network latency), it may be necessary for iTX to start a routing event a few frames before its scheduled start time. You can set it up to do this by specifying a number of frames in the **Fire Early** box; a typical setting is between 0 and 10 frames.

### Conditional Access Configuration panel

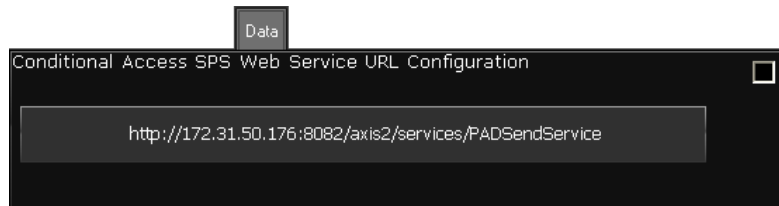

When a channel has the Conditional Access plug-in, iTX can pass conditional access data – programme-associated data IDs (PAD IDs) – in secondary events to a Scheduled PAD Server. You enter the PAD-service details in the Conditional Access Configuration panel.

### Scheduled Ingest Defaults panel

If your system includes Ingest Manager, an iTX application for managing scheduled recordings, you can set default entries for some recording-job properties. The default entries appear in the Create Scheduled Booking dialog, which operators use to create new bookings; an operator can change the default entries when creating or editing a booking.

You specify the default entries in the Scheduled Ingest Defaults panel:

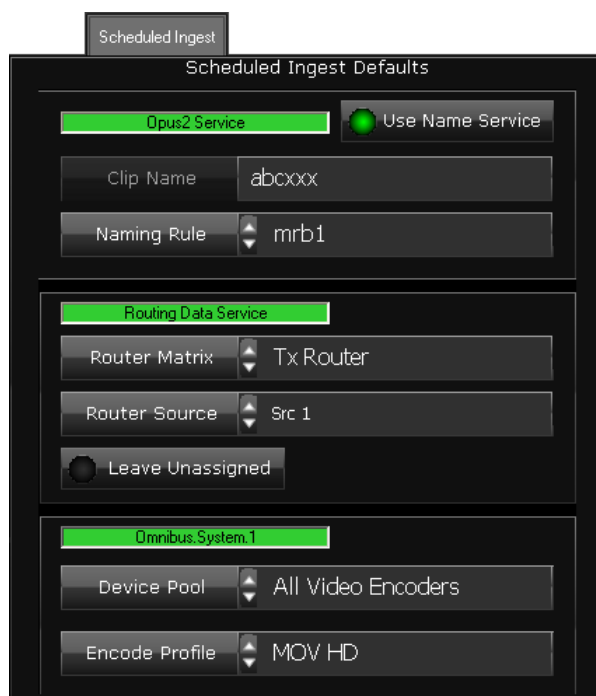

The panel appears, under the Plugins tab, if you select either the Ingest Control Service channel or the Scheduled Booking Service channel on the Channel Configuration pop-up layout.

### Configure default entries for recording jobs

1. Do the following to set naming-rule defaults.

- Select **Use Name Service** (the button indicator displays a green light).
- In the **Naming Rule** box, select a naming rule for Ingest Manager to use when naming media files formed in the recording process. Ensure the naming rule results in a different name each time.

The **Clip Name** box shows an example of a name formed by using the selected rule.

Naming rules become available after you create them in the Naming Rule Administrator. [More details](#), page 272.

2. Do the following to set routing defaults.

- In the **Router Matrix** and **Router Source** boxes, select the router and source for the video feed. Select “Hardwired” in both boxes if Ingest Manager is not going to operate a router.
- Ensure **Leave Unassigned** is not selected.

**Note:** If iTX is set up to operate a router, and your Ingest Manager layout has router-source selection buttons, you can omit the router details from the default options. You do this by selecting **Leave Unassigned**. Once a recording is scheduled, the router source can be added through the Instant Ingest Request panel on either of the Ingest Manager layouts.

3. Select a device pool in the **Device Pool** box.

Device pools become available after you create them under the Ingest Config tab. [More details](#), page 170.

4. Select an encode profile in the **Encode Profile** box.

Encode profiles become available after they are created in the Encode Settings dialog. You can display the dialog from one of the standard iTX Desktop ingest layouts. For more information, see the Operating Manual for the iTX Desktop.

5. Click **Save**.

## The External Logo panel

You can feed the output signal of a channel through an external Logo Inserter, and then use iTX to control the device to switch static logos on and off. iTX can control the following types of Grass Valley Logo Inserter.

- Imagestore 300
- Imagestore HD
- Imagestore 750
- LGK-3901 (in a Grass Valley Densité frame)

iTX can control multiple devices.

You configure iTX to work in this way through the External Logo panel:

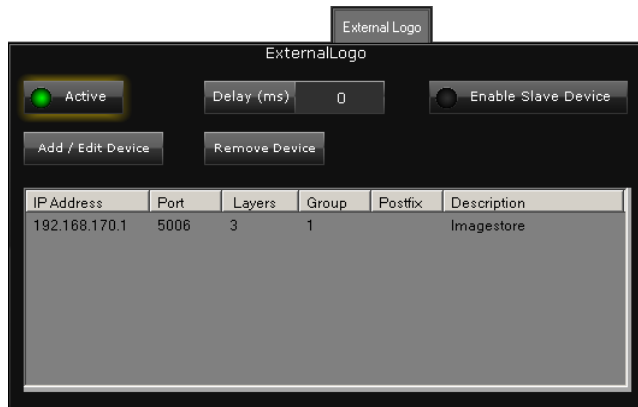

The panel displays a pane in which you can build a list of external Logo Inserters that can be used to brand the channel output.

**Note**

- For external logos with a set time, duration and automation delay, the **Delay (ms)** must be a negative value (otherwise it will be ignored and logos will go to air at their original start time).

Clicking **Add/Edit Device** displays the Add Logo Device dialog:



You enter the connection details for the external logo inserter in this dialog.

**The Logo Setup panel**

It is possible for schedules to regularly require one or two logos to be replaced before they can be used in a particular channel. An example is when a schedule that is also run on a +1 channel, the standard logos need to be replaced with +1 versions.

For such situations, you may set up iTX to automatically substitute one logo for another. You do this in the Logo Setup panel:

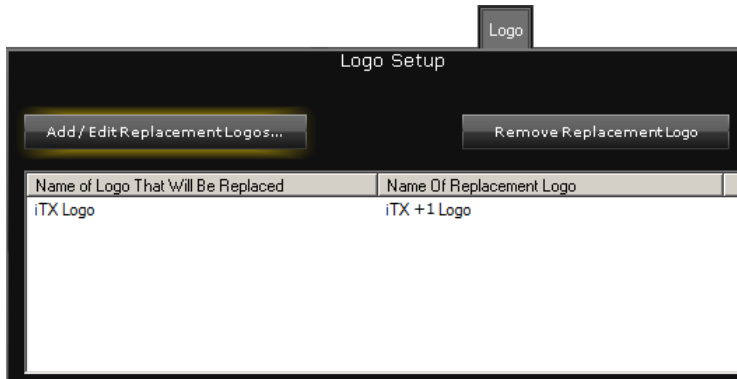

In the panel you have to manually create a list of logos to be replaced and the logos that will replace them.

Clicking **Add/Edit Replacement Logos** displays the Replace Logo dialog:

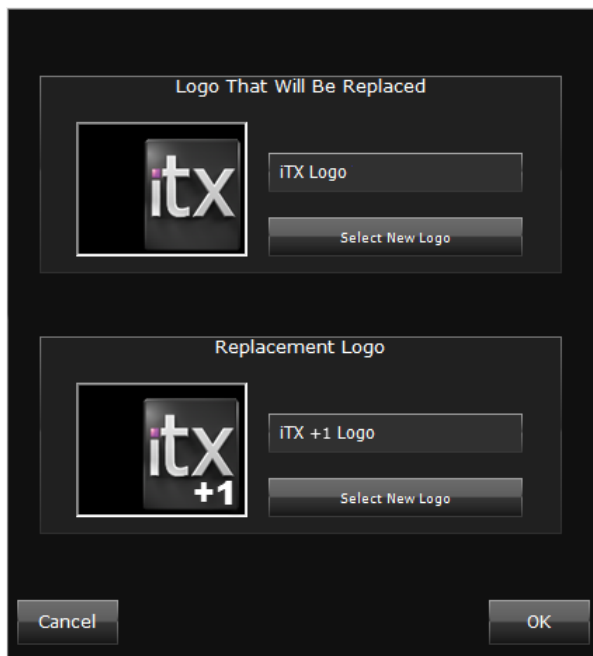

The dialog has two sections in which you specify the logos in the replacement process. In each section, you click **Select New Logo** to open the PinPoint dialog, and use PinPoint to select a logo.

Clicking **OK** closes the Replace Logo dialog and adds a logo-replacement entry to the Logo panel.

**Note:**

- You can remove any logo-replacement entry from the panel by selecting it and clicking **Remove Replacement Logo**.
- So that external logos with a set time, duration and automation delay play at the specified time, rather than the original time, set **Delay (ms)** to a negative value.
- For simulcast channels, further logo replacements can be defined in the Simulcast Channel Config tab. For more information see the *Output Server 2 Channel Configuration Guide*.

## SCTE104 Configuration panel

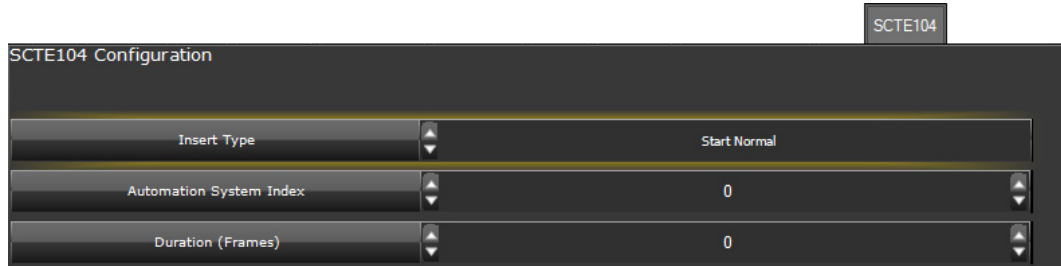

In addition to the current `splice_request_data` command offered by the VANC Configuration panel, the SCTE104 panel is able to send multiple operation outbound SCTE messages with the following optional operations:

- `segmentation_descriptor_request_data` to identify local and national avail.
- `DTMF_descriptor_request_data` for legacy DTMF commands.

This panel allows you to set the properties for enhanced SCTE104 events in a live video signal. The default values for these properties are configured in the `EnhancedSCTE.xml` file, which is located in a folder on the Output Server machine. The default path to the folder is:  
 C:\Program Files (x86)\iTX2.0\Services\TXPlay

The table below describes the option for the SCTE104 plugin:

Option	Description
Insert type	Select the type from the list. The options are <ul style="list-style-type: none"> <li>• Start Reserved</li> <li>• Start Normal</li> <li>• Start Immediate</li> <li>• End Normal</li> <li>• End Immediate</li> <li>• Cancel</li> </ul>
Automation System Index	If you are using more than one automation system for enhanced SCTE104 messages, enter the number (0-255) for the iTX automation system index. If you are using one automation system, enter "0".
Duration (Frame)	Enter the duration of the message in frames



# Configuring the audio output for a playout channel

Source audio content may be presented to iTX in a number of different forms; for example, embedded in a video file or live video signal, or in a separate audio file.

To enable iTX to play out this content, you need to configure settings that relate to a particular property of the content: the *encoded-data format*. This may be PCM, Dolby D or Dolby E; it determines what type of audio codec iTX needs to process the content.

See later in this section, “Encoded-data formats for playout”.

If your channel is running on Output Server 2, the conceptual information in this section is valid, but for configuration information see *Output Server 2 Channel Configuration Guide*.

## About audio channels and tracks (and streams)

In explaining the audio configuration options, we make the following distinction between audio channels and tracks.

- By *channel*, we generally mean the distribution path for a single audio signal or data-stream component. So, for instance, the left and right signals of a PCM stereo pair require two channels; likewise, the two parts of a Dolby D data stream.
- Channel may also mean the route along which audio content is carried to a speaker. For example, the decoding of 2 channels of Dolby D data may provide content for 5.1 surround-sound channels or a pair of stereo channels.
- A *track* contains one or more channels, of a specific type, and provides complete independent audio content for an associated video stream. For example, a PCM mono track contains just one channel; a PCM stereo track, two channels; a Dolby D track, two channels.
- Sometimes, the word *stream* is used instead of track.

This illustration shows the output of 2 data (D) channels in a Dolby D track from 6 mono (M) channels in a PCM track:

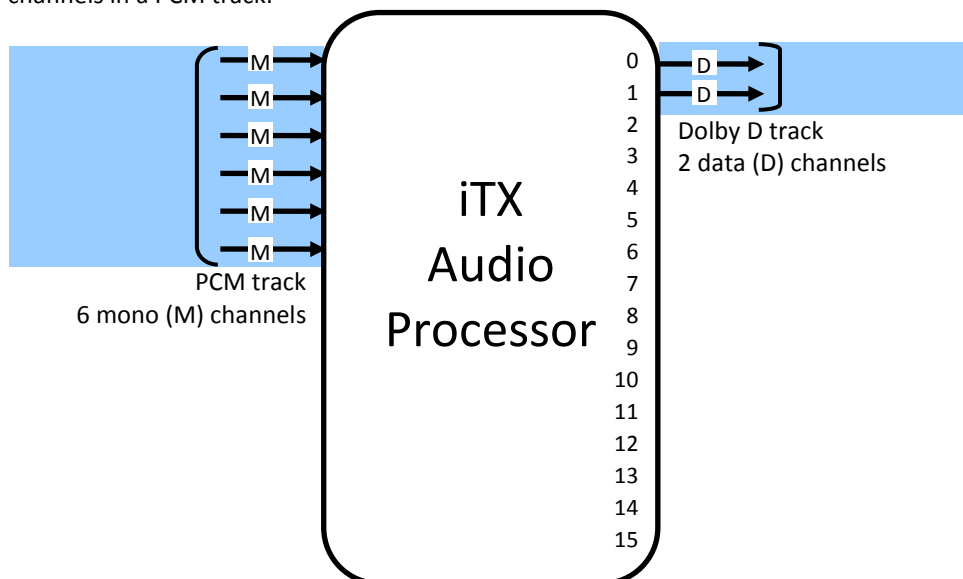

## Output-channel limit

An Output Server can play out multiple audio tracks in different formats. The number of tracks and their formatting depend on the channel configuration. The total number of channels in all output tracks cannot be greater than 16. This limit is set by the SDI standard.

## Encoded-data formats for playout

iTX can handle audio content in any of three encoded-data formats:

- PCM, uncompressed digital audio.
- Dolby D, compressed data.
- Dolby E, compressed data.

To mix or overlay audio sources (for transitions or voiceovers), iTX requires the content to be in PCM format. This means it must decode any Dolby E or Dolby D data before it can work with it. After processing the content, it may re-encode it for delivery in either of these formats. For such functionality to be available, your system requires specific iTX Licenses.

Sometimes, an item of media has multiple audio tracks with content in more than one of the accepted formats. In each track there are usually a number of channels to carry the audio information.

A PCM track can contain 1, 2, 4, 6, 8 or 16 channels. These may be mono, stereo pairs or discrete surround-sound channels.

A Dolby D track has 2 channels to carry the compressed data. This data, when it is decoded and converted into analogue form, may produce 6 channels of 5.1 surround-sound content and a pair of stereo channels (sometimes called a stereo downmix).

A Dolby E track has 2 channels of compressed data. The data produces 6 channels of 5.1 surround-sound content; or 6 channels of 5.1 surround-sound content with 2 other channels; or 2 pairs of stereo channels, in which there is silence on the second pair.

We sometimes use this shorthand notation to refer to the Dolby Digital channel formats:

- AC-3 3/2 for the 5.1 surround-sound channels.
- AC-3 2.0 for the stereo pair.

The Media Watcher operation is controlled by a configuration option – [more details](#), page 76.

## Configuring the audio output of an Output Server

To configure an Output Server to embed one or more audio tracks in its SDI output signal, you specify the output requirements. iTX then uses the available sources to produce the required output.

In selecting which source track(s) to use, it follows a set of rules. (See later in this section, "How iTX determines which source track to use for the output" on page 201.)

For the configuration, you use the Audio Mapping panel on the Channel Configuration pop-up layout:



Under this tab, you configure the audio output from sources in media files.

**Note:**

- To configure the audio output for live assets, you use the Property Editor on the Asset layout.

**Selecting the audio type**

In the simplest configuration of a single output track, you just select the audio type of the track (e.g. Dolby D 2.0). iTX selects audio sources, processes them and embeds a track of the selected type in its SDI output.

You can configure the Output Server to produce more tracks until all 16 channels that are available in an SDI signal are used.

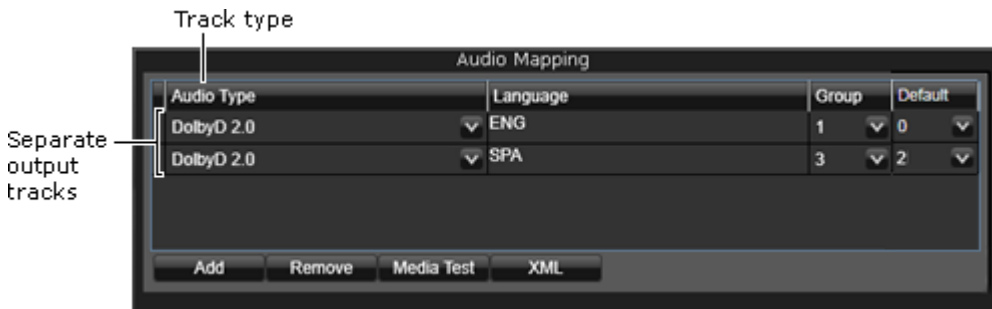

You can specify an output track to be one of a number of audio types, based on the encoded-data format of the content. The following table gives details of these, which are identified in iTX by a type number.

Different types require different numbers of channels.

Audio Type	Type No.	Channels	Description
DolbyD (Auto)	0	2	Dolby Digital data. Depending on the source tracks used, when decoded this may give: <ul style="list-style-type: none"> <li>– Either 5.1 surround-sound channels (AC-3 3/2).</li> <li>– Or a stereo downmix (AC-3 2.0).</li> </ul>
DolbyD 2.0	8	2	Dolby Digital data (AC-3 2.0). Source audio that has 5.1 channels is downmixed.
DolbyE 5.1+2	10	2	Dolby E data. When decoded, this gives 5.1 surround-sound channels and 2 other channels. The output is available only when the source audio is Dolby E 5.1+2.

Audio Type	Type No.	Channels	Description
DolbyE 5.1	11	2	Dolby E data. When decoded, this gives 5.1 surround-sound channels.  The output is available only when the source audio has 6 channels.
DolbyE (Auto)	12	2	Dolby E data. Depending on the source tracks used, when decoded this may give: – Either 5.1 surround-sound channels. – Or two stereo pairs (2+2), with silence on the second pair.
Raw (2 Ch)	1	2	Content from a source audio track that passes through the audio processor without change (there is no de-coding or mixing of the content). The track may contain two PCM channels, a pair of Dolby Digital data channels or a pair of Dolby E data channels.
PCM (Auto)	4	1, 2, 4, 6, 8 or 16	Discrete PCM channels. The number of output channels depends on the number of source channels.
PCM 5.1	9	6	Six discrete PCM channels from a 5.1 source track.
PCM Stereo	5	2	PCM stereo (left/right) pair.
PCM Mono	6	1 (in a channel pair)	PCM mono.  Source tracks of single mono channels must be paired for playout in a stereo track.

### Compatibility of source tracks

For iTX to be able to use a particular source track for playout, the track must be: either of the same audio type as the required output track; or of another audio type that makes the source track compatible with the output track.

A compatible source track is one that iTX can use to produce the output track. In the table below, we list some compatible source track types for possible output types. The table relates to primary events only.

Output audio type	Compatible source track types
Dolby D (Auto)	<p><b>For a Dolby D 2.0 output:</b></p> <p>Dolby D 2.0. A PCM stereo pair, or 2 grouped mono tracks.</p> <p><b>For a Dolby D 5.1 output:</b></p> <p>Dolby D 5.1. Dolby E 5.1; Dolby E 5.1+2 (the +2 source channels are omitted). 6 consecutive or grouped PCM mono tracks.</p>

Output audio type	Compatible source track types
DolbyD 2.0	Dolby D 2.0; Dolby D 5.1 (downmix).  Dolby E 5.1 (downmix); Dolby E 5.1+2 (downmix, with the +2 source channels omitted).  A PCM stereo pair, or 2 grouped mono tracks.  6 consecutive or grouped PCM mono tracks (downmix).
DolbyE 5.1+2	Dolby E 5.1+2
DolbyE 5.1	Dolby D 5.1.  Dolby E 5.1; Dolby E 5.1+2 (the +2 source channels are omitted).  6 consecutive or grouped PCM mono tracks.
DolbyE (Auto)	<b>For a Dolby E 2+2 output</b> (with silence on the +2 tracks):  Dolby D 2.0.  A PCM stereo pair, or 2 grouped mono tracks.  <b>For a Dolby E 5.1 output:</b>  Dolby D 5.1  Dolby E 5.1; Dolby E 5.1+2 (the +2 source channels are omitted).  6 consecutive or grouped PCM mono tracks.
Raw (2 ch)	Any 2-channel source: PCM, Dolby D or Dolby E.  (Source compatibility is not relevant, since iTX outputs the audio content just as it is in the source media; i.e. without processing it.)
PCM (Auto)	Dolby D 2.0; Dolby D 5.1.  Dolby E 5.1; Dolby E 5.1+2.  A PCM stereo pair.  1, 2, 4, 6, 8 or 16 consecutive or grouped PCM mono tracks.
PCM 5.1	Dolby D 5.1.  Dolby E 5.1; Dolby E 5.1+2 (the +2 source channels are omitted).  6 consecutive or grouped PCM mono tracks.
PCM stereo	Dolby D 2.0; Dolby D 5.1 (downmix).  Dolby E 5.1 (downmix); Dolby E 5.1+2 (downmix, with the +2 source channels omitted).  A PCM stereo pair, or 2 grouped mono tracks.
PCM mono	PCM mono track.

The following diagrams show how iTX may produce a single output of a selected audio type (PCM stereo) from media files with different types of audio content.

## Examples of a PCM stereo output from various source types

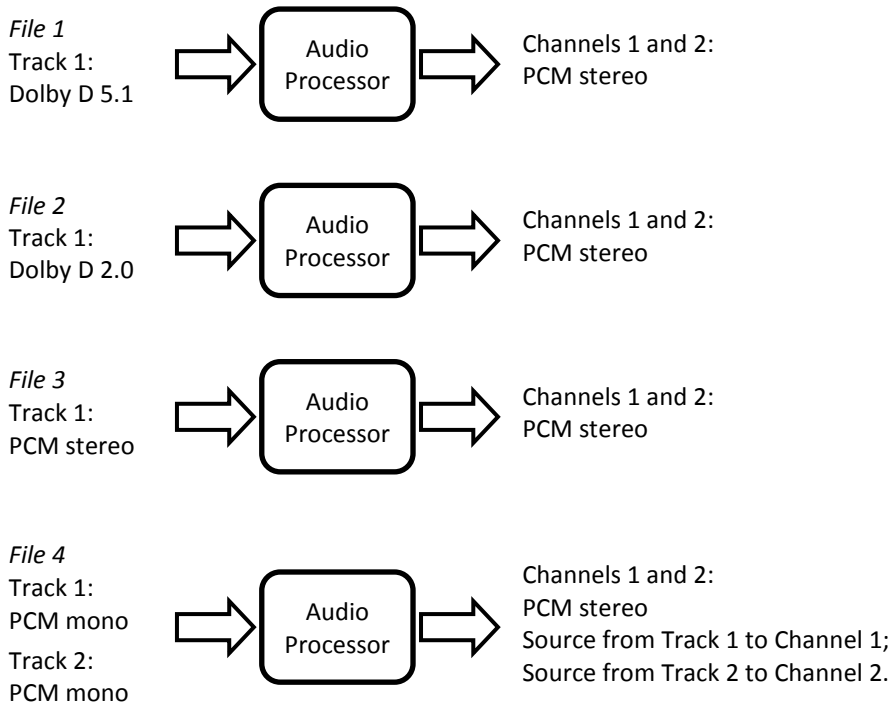

## Distribution of source PCM channels in a Dolby D 5.1 output

Compatible sources for a Dolby D 5.1 output include 6 PCM mono channels. In this case, iTX distributes the source content to the output channels in this way:

- The content of the first source channel to the left output channel; the content of the other source channels, in order, to the right, centre, LFE, left-surround and right-surround output channels.

## Channel mapping

Source media may contain a number of alternative audio tracks for use in different situations. For instance, a media file for a movie may have a number of foreign-language tracks to cater for playout requirements in different countries. iTX can select any particular channel by using channel-mapping functionality. You configure this functionality in the Audio Mapping panel.

For channel mapping of a media file or live video feed, you may identify a source track in the following:

- By a tag with which the track is labelled. Foreign-language tracks in a media file often have standard 2- or 3-letter tags assigned to them in a post-production process; e.g. ENG, FRA, SPA for English, French and Spanish.
- By a group number. This indicates the position of the track in the source media; also, a relationship (for output purposes) between any tracks with the same group number. Tracks may have group numbers 0 to 15.
- By assigning a default group. This indicates the group to use, if no tag or group can be determined.

In the Audio Mapping panel, you select track tags in the **Language** boxes:



You may specify a group of tags, listed in order of preference. This instructs iTX to select an alternative track for the output when the preferred track is not available (e.g. to play out an English track when a Spanish track is not available).

In some systems, tags may include an extra character after the main part of the tag. For instance, ENGL and ENGR may identify the left (L) and right (R) channels of an English (ENG) stereo track. iTX allows a tag to end with any such character without it affecting search results. So it treats the tracks with ENGL and ENGR tags the same as tracks with the ENG tag when searching for tracks with a specific tag.

You select group numbers in the **Group** boxes:



You may select any one of up to 16 groups (numbered 0 to 15) in the source media. See below, “Track grouping”.

### Pass-through option

Selecting **Pass** sets up iTX to use the audio passthrough option, to produce multiple PCM stereo outputs from pairs of successive PCM mono tracks. The option relates to early versions of iTX v2, in which it was not possible to identify the required tracks by group numbers.

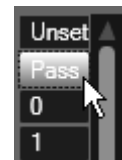

Since the introduction of the channel-grouping functionality, this option is no longer required. When you want iTX to use channels from different mono tracks for a PCM stereo output, you should use channel grouping to identify channel pairs.

## How iTX determines which source track to use for the output

In selecting which source track to use for an output track, iTX follows a set of rules that take account of the Audio Mapping configuration. The rules cause iTX to perform a series of checks in the order given below, until it finds a track that meets the requirements.

In this process, iTX treats multiple tracks with the same group number as a single track – when it selects a particular group for playout, it uses all the tracks in the group.

### 1. Tag matching

- iTX first notes whether or not there is a Language tag specified. If there is, it checks source tracks that are of the same audio type as the output track; when it finds a track with a tag that matches the one specified, it selects this track for playout.
- If there is no such track, iTX searches compatible source tracks of other audio types. If it finds a track with the required tag, it selects this track for playout.
- If the output format is PCM stereo and there is only a PCM mono source track with the required tag, iTX assigns this track to both left and right stereo outputs.

**2. Group matching**

- If there is no suitably tagged track, iTX notes whether or not there is a group number specified in the configuration. If there is, it selects the compatible source track with this number.
- If the output format is PCM stereo and there is only a PCM mono source track with the required group number, iTX assigns this track to both left and right stereo outputs.

**3. Default matching**

- If neither tag matching nor group matching can be applied, iTX can apply a default group to the track. The default group can be specified from the **Default** column in the Audio Mapping section.
- If the output format is PCM stereo and there is only a PCM mono source track that is untagged, iTX assigns this track to both left and right stereo outputs.
- If the **Default** column is set to Silence, the output from that track will be mute.

**4. Use of untagged tracks**

- If there is no track that matches the Language or Group configuration entries, iTX selects the first untagged source track that is of the same audio type as the output track. If there is no such track, it selects the first compatible untagged track.
- If the output format is PCM stereo and there is only a PCM mono source track that is untagged and cannot be set to Default, iTX assigns this track to both left and right stereo outputs.

**5. Use of a compatible source track**

- If the previous steps fail to identify a suitable track, iTX selects the first source track if it is compatible with the specified output type.

**Track grouping**

Tracks in a media file or live asset have numbers that indicate the relative positions of the tracks; the first track is track 1, the second is track 2, and so on.

For mapping purposes, iTX gives each track a group number. The group number also indicates the relative position of the track, but group numbers start at zero. So, track numbers and group numbers correspond in a way shown by the table below.

Track number	Group number
1	0
2	1
3	2



Track number	Group number
4	3

iTX can use multiple consecutive source tracks to provide the content for a single output track. It may do this, for instance, to play out a PCM stereo track from two consecutive mono tracks. In selecting the source tracks, it identifies them by their group numbers.

To enable iTX to use two non-consecutive PCM mono tracks for a stereo channel, the tracks may be grouped together by giving them the same group number; the channels then act as a stereo pair.

The grouping can be done automatically by the Media Watcher when a file is ingested, or manually by an operator on the Asset layout. The Media Watcher operation is controlled by the **Group Mono Tracks** configuration option on the service window (under the Setup tab).

For a media file with four mono tracks, for example, we may change the group number of track 4 to be the same as that of track 2. This table shows the modified group numbering:

Track number	Group number
1	0
2	1
3	2
4	1

iTX can then use tracks 2 and 4 together, for a PCM stereo playback, by selecting group 1.

### Track-group numbering for mono-track outputs

Once two tracks are grouped together (i.e. have the same group number), iTX treats them as a stereo pair. Since iTX does not split stereo pairs to produce a mono output, this means neither track in the same group can then be mapped to a mono output track.

Because of this, if the audio output of a channel is to include mono tracks, the default group numbers should not be modified. Ensure **Group Mono Tracks** under the Media Watcher Setup tab is not selected.

### Replicating a mono source track for a PCM stereo output track

When the channel configuration specifies a PCM stereo output track, and the only available track is a PCM mono track, iTX replicates the mono track and plays it on both (left and right) channels of the output track.

### XML code for the channel-mapping configuration

The channel-mapping configuration is stored as XML code in the System Database. From the Audio Mapping panel, you can open an XML Viewer to view the XML code for a selected configuration:

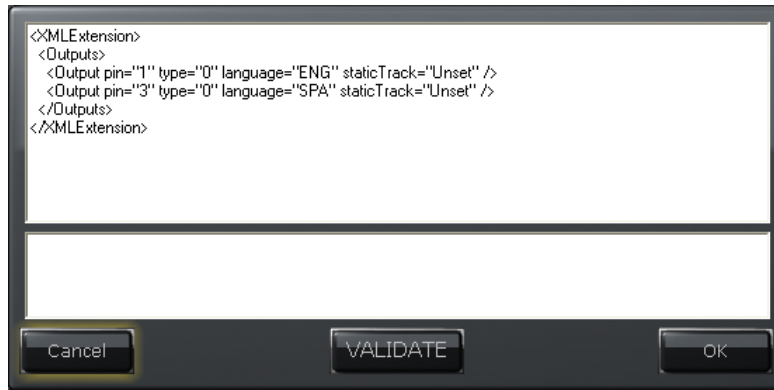

This is an example of a configuration for two Dolby D (Auto) output tracks with English and Spanish tagged content:

```
<XMLExtension>
  <Outputs>
    <Output pin="1" type="0" language="ENG" staticTrack="Unset" />
    <Output pin="3" type="0" language="SPA" staticTrack="Unset" />
  </Outputs>
</XMLExtension>
```

Each Output element has four attributes:

- The pin attribute is associated with a channel in the output track. iTX allocates groups of pins in order based on the channel requirements of the selected encoded-data format. So, for instance, two pins are allocated to a Dolby D data stream. In the XML code, only the first pin in a group needs to be specified.
- The type attribute specifies the number that identifies the audio type of the output track. See earlier in this section, "Selecting the audio type".
- The language attribute specifies the tag of a required source track.
- The staticTrack element specifies the number of a required source track.

## Testing a channel-mapping configuration

From the Audio Mapping panel, you can test the audio mapping for a selected media file. When you do this, iTX creates a report that lists all available audio tracks and describes the effect of the configuration. It displays the report in the Report Viewer:

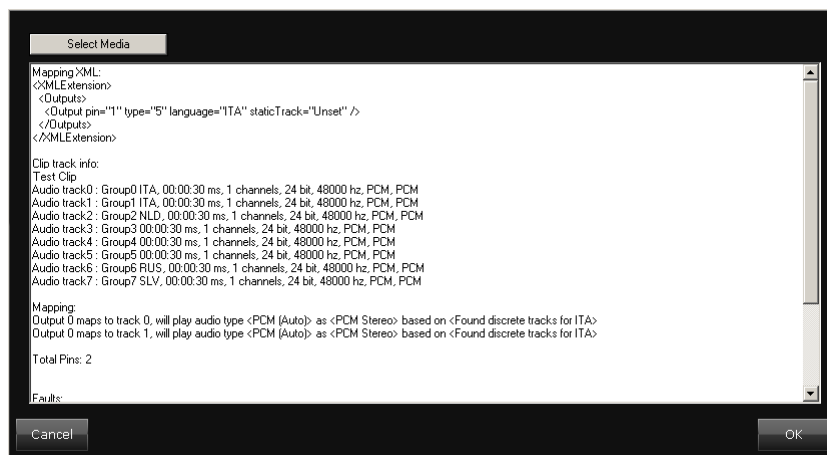

Below is an example of a test report for a clip with 8 audio tracks.

**Mapping XML:**

```
<XMLExtension>
  <Outputs>
    <Output pin="1" type="5" language="ITA" staticTrack="Unset" />
  </Outputs>
</XMLExtension>
```

**Clip track info:**

```
Test Clip
Audio track0 : Group0 ITA, 00:00:30 ms, 1 channels, 24 bit, 48000
hz, PCM, PCM
Audio track1 : Group1 ITA, 00:00:30 ms, 1 channels, 24 bit, 48000
hz, PCM, PCM
Audio track2 : Group2 NLD, 00:00:30 ms, 1 channels, 24 bit, 48000
hz, PCM, PCM
Audio track3 : Group3 00:00:30 ms, 1 channels, 24 bit, 48000 hz,
PCM, PCM
Audio track4 : Group4 00:00:30 ms, 1 channels, 24 bit, 48000 hz,
PCM, PCM
Audio track5 : Group5 00:00:30 ms, 1 channels, 24 bit, 48000 hz,
PCM, PCM
Audio track6 : Group6 RUS, 00:00:30 ms, 1 channels, 24 bit, 48000
hz, PCM, PCM
Audio track7 : Group7 SLV, 00:00:30 ms, 1 channels, 24 bit, 48000
hz, PCM, PCM
```

**Mapping:**

```
Output 0 maps to track 0, will play audio type <PCM (Auto)> as <PCM
Stereo> based on <Found discrete tracks for ITA>
Output 0 maps to track 1, will play audio type <PCM (Auto)> as <PCM
Stereo> based on <Found discrete tracks for ITA>
```

Total Pins: 2

**Faults:****Final Output Mapping XML:**

```
<XMLExtension>
  <Outputs>
    <Output pin="1" stream="0" type="5" sourceType="4" ID="0" />
    <Output pin="2" stream="1" type="5" sourceType="4" ID="0" />
  </Outputs>
</XMLExtension>
```

The Mapping XML section shows the channel is configured for the output of one track of PCM Stereo (audio type 5), with Italian content; the output track starts on pin 1 (channel 1).

The Clip Track Info section lists all the tracks in the selected media file. There are 8 tracks (or streams), each containing one channel.

The Mapping section shows how iTX is to play out the file in the current channel: two Italian source tracks (tracks 0 and 1) to the first PCM stereo output track (output 0).

The Final Output Mapping XML section shows how the source tracks are distributed across the channels in the PCM stereo output track: track 0 (or stream 0) on the first channel (pin 1); track 1, (or stream 1) on the second channel (pin 2).

## Clip mapping

To ensure a consistent audio output when there are variations in the number of audio tracks, or their types, in source media files, you should specify the required output type in the Audio Mapping panel.

However, where the audio properties of all source media files are the same, you may set up iTX to play out the audio content exactly as it is in the source media. So, for example, iTX then outputs two PCM stereo tracks when the media contains two PCM stereo tracks; or an AC-3 track when the media contains an AC-3 track.

We call this type of configuration *clip mapping*. You set it up by clearing all entries under the Media tab in the Audio Mapping panel.

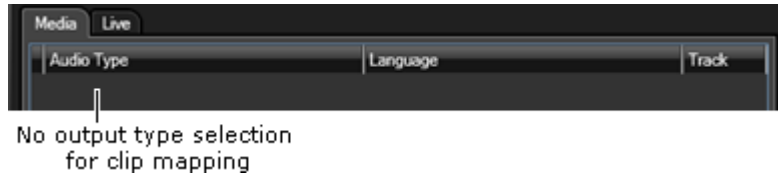

You should only use clip mapping where all media files contain PCM audio tracks, or where all assets have the same audio configuration. You should not use it where there is a mixture of source audio formats that include Dolby Digital or Dolby E.

**Note:** Mapping of audio streams is not permitted on 'live' event inputs – for example, if tracks 1 and 2 are a PCM stereo pair in the live source, they cannot be duplicated or moved to tracks 3 and 4 on play out.

## Using the Audio Mapping panel

You use the Audio Mapping panel to specify the number, format and channel-mapping of audio tracks in the SDI output signal. Through this panel, you may:

- Add an audio track to the output of a playout channel.
- Remove an audio track from the output of a playout channel.
- Configure the output audio tracks for a playout channel.
- View the XML code for the channel mapping of an audio track.
- Display a test report for any media file, giving details of the audio tracks in the file and how they are to be used in the channel output.

After changing any of the configuration on the Audio Mapping panel, you need to click **Save** on the same layout to save your changes.

### Display the Audio Mapping panel

1. On the Engineering layout, click **Channel Config** to display the Channel Configuration pop-up layout.
2. Select a channel view in the **View** box; select a playout channel from the Channel Selector.
3. Under the Channel tab, select the Channel Config 4 tab.

The Audio Mapping panel appears under this tab.

## Add an audio track to the output of a playout channel

1. On the Audio Mapping panel, click **Add**.

iTX adds an entry for a new audio track in the Audio Mapping panel. You need to configure this as described below, "Configure an output audio track".

## Remove an audio track from the output of a playout channel

1. On the Audio Mapping panel, select an entry for an audio track.
2. Click **Remove**.

iTX removes the entry from the Audio Mapping panel.

**Note:** If you remove all entries from under the Media tab, you set up iTX for clip mapping. [More details](#), page 205.

## Configure an output audio track

1. For any entry in the Audio Mapping panel, select an output type from the **Audio Type** dropdown box.
2. If you want to specify track tags for iTX to search for among source audio tracks, do the following.
  - Click the **Language** box to display the Language Selection dialog:

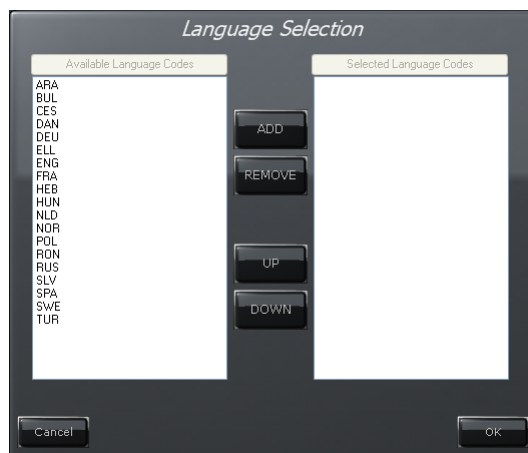

- Select a tag in the Available Language Codes pane; click **Add** to add it to the Selected Language codes pane. Do this for each tag you want to add. You may add multiple tags together by using the Shift or Control key to select them as a group before clicking **Add**.
  - To remove a tag from the Selected Language Codes pane, select it and click **Remove**.
  - If you add multiple tags to the Selected Language Codes pane, ensure they are listed in order of priority; the tag for most preferred language should be at the top. To re-position a tag, select it and click **Up** or **Down**.
  - Click **OK** to close the dialog.
3. If you want to specify the number of a source group, select one from the **Group** dropdown list.
  4. Click **Save** on the Channel Configuration Tool.

**Note:**

- You can modify the list of tags in the Available Language Codes pane. See below, "Modifying the list of available track tags in the Language Selection dialog".

**Display the XML code for a channel-mapping configuration**

- On the Audio Mapping panel, click **XML**.

iTX opens the XML Viewer; this shows the XML code for the channel mapping of the configured audio tracks.

**Display a report showing the audio-track details for a video clip**

- On the Audio Mapping panel, select the Media tab.
- Click **Media Test** to open the Report Viewer; this appears blank.
- Click **Select Media** to open PinPoint, the iTX search tool.
- Select a video clip and close PinPoint.

iTX displays a report for the clip in the Report Viewer.

The report gives details of the channel-mapping configuration, the audio tracks in the clip, and the tracks selected for playout.

**Modifying the list of available track tags in the Language Selection dialog**

A number of 3-letter language tags are stored in the System Database. These appear in a default list in the Available Language Codes pane the first time you open the Language Selection dialog.

Right-clicking the pane displays a menu that you can use to modify the list:

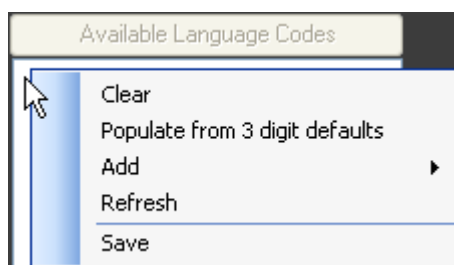

Through the menu, you can:

- Clear the current list of tags from the pane.
- Add the default list of tags to the pane.
- Add a custom entry to the list. Select **Add** to display a text box; type your tag in the text box and press Enter; the tag appears in the list.
- Refresh the pane to display the current saved list; this cancels any modifications you make but do not save.
- Save your modifications.

## Upgrading a system that is configured for clip mapping

If you upgrade your iTX system from an earlier version that does not have the Audio Mapping panel, there is no need to amend the existing configuration if it uses the static-mapping option.

For any output channel for which the clip-mapping option is selected, you need to set up clip mapping in the Audio Mapping panel.

## Output Server settings for Dolby Digital and Dolby E audio

The bit rate and a number of other properties of any Dolby Digital or Dolby E data track are configuration settings in the Dolby Settings panel in the Configure Output Server dialog:



The default settings should be suitable for most situations. You should only change a setting if you are familiar with the properties of Dolby formats.

## Running iTX services

Once you start iTX services via their Server Controllers, they continue to run without you having to take further action. If a temporary fault (for instance, one arising from a network problem) causes any service to stop running, the Server Controller monitoring that service automatically restarts it.

The Server Controllers and iTX services display the same type of user interface, in the form of a window that you can move and resize. This illustration shows the System Service window:

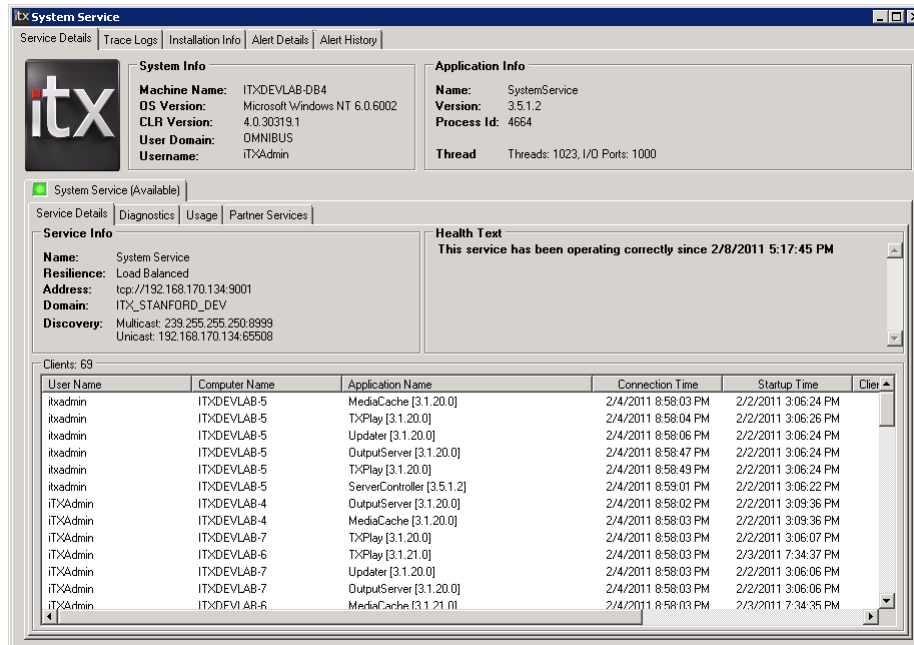

The service windows give general system information, and have diagnostics and logging features – all arranged under selection tabs. Some tabs are common to all services. The windows of individual services may display additional tabs for information and features that are specific to the functionality of those services.

In this section, we first describe the common service-window tabs; we then describe the features and extra tabs of individual services.

You can get full access to the service windows, with all the tab options, by logging onto the system servers locally. You need to do this to configure some services. But, for most daily system-administration tasks, you do not need this type of access. This is because the essential information and functionality is available on iTX Desktop layouts at your system-administrator workstation. [More details](#), page 263.

**Note:** To view a service window, you may need to click its selection button in the Windows taskbar.

## Common user-interface tabs

Three main selection tabs are common to most service windows:

- Service Details.
- Trace Logs.



- Installation Info

Individual services may display extra tabs. For instance, the System Service displays Alert Details and Alert History tabs:



### The Service Details tab

The information under the Service Details tab is divided into three categories, identified by these sub-tabs:

- Service Details.
- Diagnostics.
- Usage.

If the service is running in load-balanced mode, a fourth sub-tab appears:

- Partner Services.

The **Service Details** sub-tab under the **Service Details** main tab shows this information:

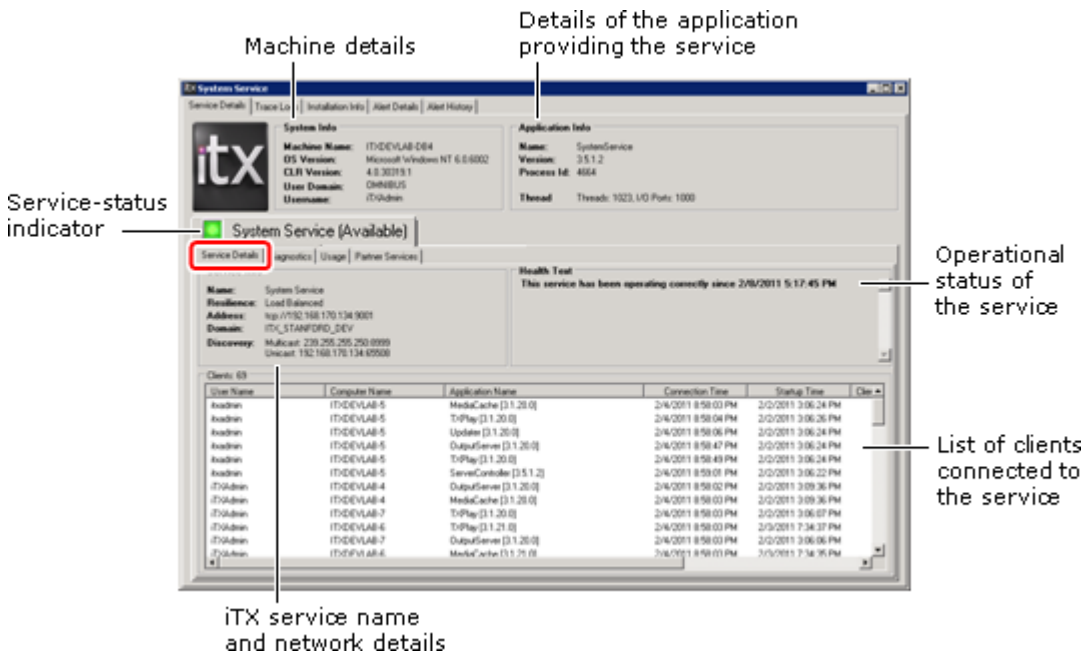

A green light in the service-status indicator shows a service is running normally. A yellow light indicates a warning condition; a red light, service failure; no light, the service is not running.

The Health Text Window provides the current status of the service and how long it has been running correctly. It also details any general warnings that might affect the running of the system. E.g. The server controller health text window will automatically issue a warning if the machine it is running on becomes low on disk space. This is particularly pertinent to Output Servers or Database Servers. The default value for when a warning is issued is 4% of disk space remaining. NOTE: This can be changed to a lower or higher amount in the Server Controller config file by adding and then editing the following XML values:

```
<appSettings>
  <add key="LowDiskSpacePercentage" value="10"/>
</appSettings>
```

```
<add key="LowDiskSpaceTimeCheck" value="60"/>
</appSettings>
```

The time check value is seconds.

Any system service can perform some basic diagnostics tests on itself. It displays test details and results in the pane under the **Diagnostics** sub-tab:

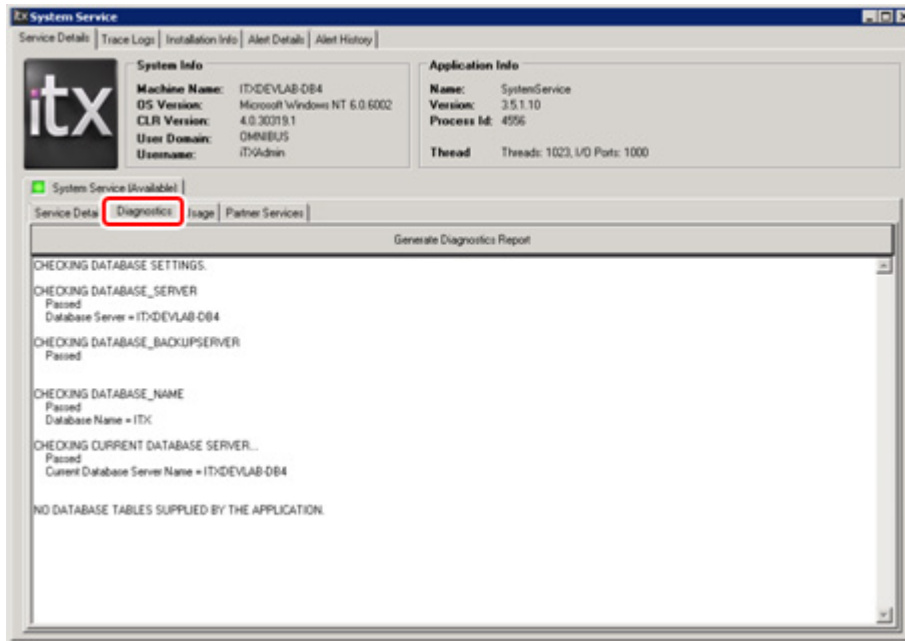

**Run a diagnostics test**

1. Select the Diagnostics tab.
2. Click **Generate Diagnostics Report**.

The service performs a series of tests and displays a test report.

Under the **Usage** sub-tab, you can view measures of some aspects of service activity:

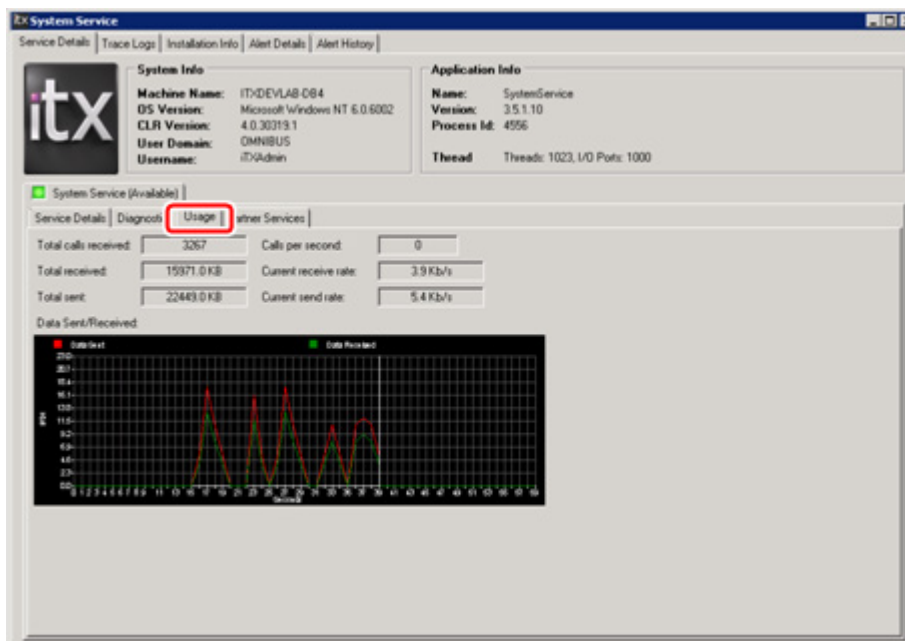

Two lines in a graphical display trace the variation over time of data sent and data received by the service.

## The Trace Logs tab

The **Trace Logs** tab presents options for switching on and off the recording of system events, which fall into different categories:

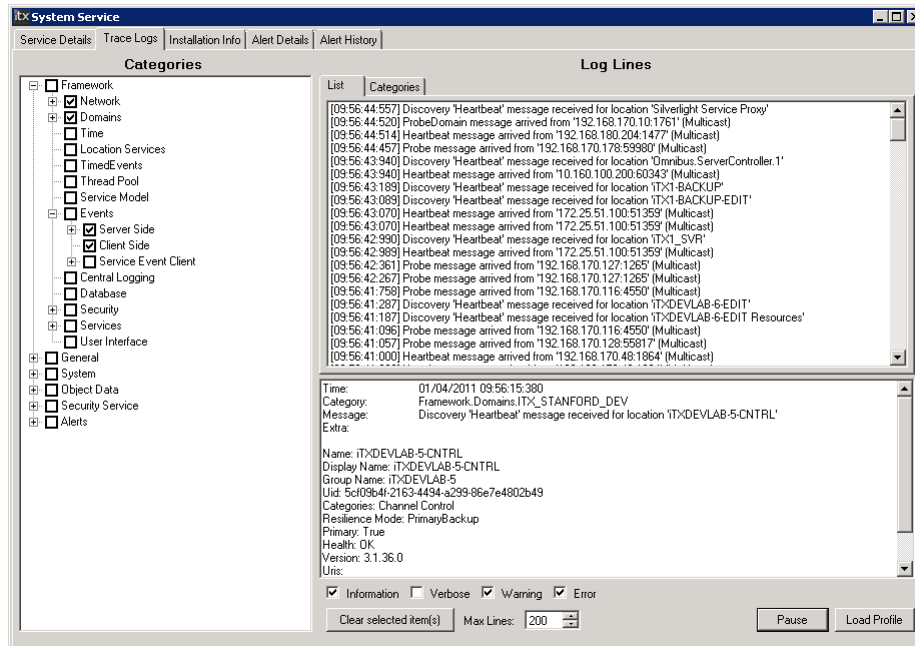

By default, trace-logging is switched off; this is because the low-level logs that are generated are of interest only to iTX software developers.

If you switch trace-logging on, you can view the logs as a service creates them. You can switch it on for individual categories by selecting their check boxes in the Categories list.

You can pause and resume logging by right-clicking inside the Categories or Log Lines pane and selecting **Pause Logging** or **Resume Logging** from the displayed menu. Alternatively, you may use keyboard shortcuts – Control + P to pause, Control + R to resume; or you may click the **Pause/Resume** button. iTX does not create trace logs for system events that happen during a pause.

You can view logs in the Log Lines upper and lower panes. The logs are arranged either by category (under the Categories tab) or in the order in which they occur (under the List tab):

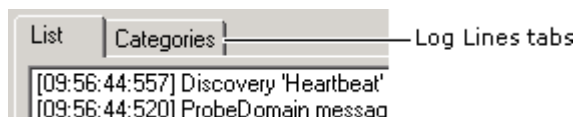

In each view, the log lines appear in the upper pane; the lower pane shows full details of any log line you select in the upper pane. You can copy log lines or full details, for pasting into a word-processing application; to do so, you right-click a pane and select one of the copy options from the displayed menu.

The number of log lines displayed for each category is limited to keep the information easy to track; the system deletes old log lines as it creates new ones. You set this limit in the **Max Lines** box. You can manually delete lines by selecting them and clicking **Clear Selected Item(s)**.

**Note:**

- High-level logs that are more meaningful than trace logs for system-administration purposes are managed by the Logging Service.

**Using a log profile**

You can set up a service to save trace logs to disk by using a log profile. This may be useful in providing information to iTX developers about problems that are difficult to diagnose.

A log profile instructs a service to write the logs from selected categories to a file in a specified location; the log profile is contained in an XML file, called *applicationName.exe.logging*, in the program folder.

As an alternative to specifying a separate file for the trace logs, a log profile may direct the service to pass the logs to the iTX Logging Service, for including in its daily logs. [More details](#), page 220.

The iTX Installer creates a default log profile in the program folder; you can create custom ones by doing the following.

1. Select log categories in the Categories pane.
2. Right-click inside the Categories pane; select **Log Profile** and then **Create Profile using current selection** from the displayed menu.

The service saves the file in a location specified in the log profile.

To set up a service to use a log profile, you click **Load Profile**.

**The Installation Info tab**

The **Installation Info** tab displays a pane containing the software build details of the service:

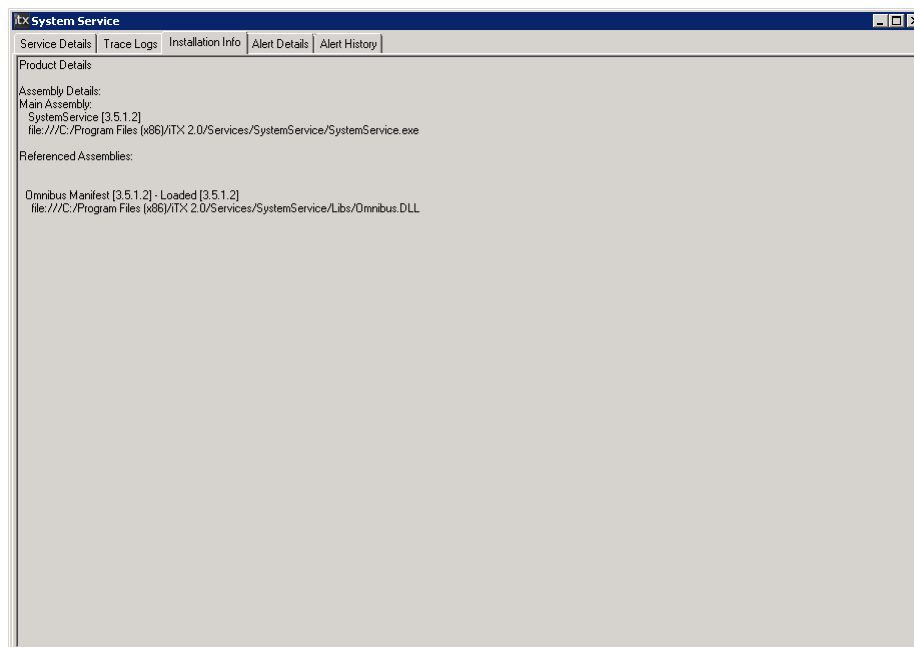

## Using the Server Controller Configuration tool

During the installation of services on a machine, the iTX installer configures the Server Controller on that machine to run the installed services.

Included in the configuration may be start-up parameters, which control what properties a service has when the Server Controller starts it; for example, the service name.

You can view the entries for the start-up parameters under the Controlled Services tab of the Server Controller window:

Service Name	Status	Startup Parameters
Updater	Running	
Media Cache	Running	-ui -n iTX-5-CACHE
TxPlay	Running	-ui -n iTX-5
Output Server	Running	-ui -n iTX-5 -t AJA...

### Example

An Output Server may have these start-up parameters:

```
-ui -n iTX -t AJAXena
```

## Start-up parameters

In the following tables, we explain some of the start-up parameters that may be used in a Server Controller configuration. A word in *italics>* after a parameter in the left column shows the type of value that needs specifying to complete a setting.

For all services:

Start-up parameter	Description and comments
-ui	Causes a service to display a user interface in the form of a service window.
-n <i>name</i>	Specifies the name of the service. Example, for a channel called "Sports 1": -n Sports 1

For services that support the primary/backup operating model:

Start-up parameter	Description and comments
-backup	Identifies a back-up service.

### Note:

- Not all services can operate as back-up services.
- You should not configure a Media Watcher or a Media Data Service to run as a back-up service.
- If a service is set up to run in a load-balanced mode (rather than as a primary/backup service), entering a "-backup" argument has no effect.

For an Output Server or Encode Server:

Start-up parameter	Description and comments
-t <i>card type</i>	Describes the type of video or audio card fitted in the host machine.  Example, for an AJA Xena video card: -t AJAXena

For the Time Service

Start-up parameter	Description and comments
-timezoneoffset	Applies the timezone offset (from UTC) that is configured in the Windows Control Panel to the reference time.
-format <i>television standard</i>	Specifies the television standard (NTSC, PAL, etc.) that determines the playout frame rate.  Example, for the NTSC Drop-Frame standard: -format NTSCDF
-NTPexternal	In a system with no VITC generator, instructs the Time Service to use an external NTP (Network Time Protocol) server. This parameter causes the service to re-direct iTX services that request time to the external server.  The parameter requires the -address and -port parameters (see below) for the external server.
-address <i>IP address</i>	When used with -NTP external, specifies the IP address of an external NTP server.  Example: -address 192.168.100.200
-port <i>IP port</i>	When used with -NTP external, specifies the port number on which the services are to communicate with the NTP server.  Example: -port 8995
-slave <i>IP address : port number</i>	In a system with no VITC generator, instructs the Time Service to get its reference time from an external NTP (Network Time Protocol) server (using the specified IP address and port number). This parameter causes the service to relay the time from the external server to other iTX services.

For services that can run in a special configuration mode:

Start-up parameter	Description and comments
-config	Switches the service to start in configuration mode. You need to remove this parameter before you can run the service in the normal operating mode.

You can modify start-up parameters by using the Server Controller Configuration tool:

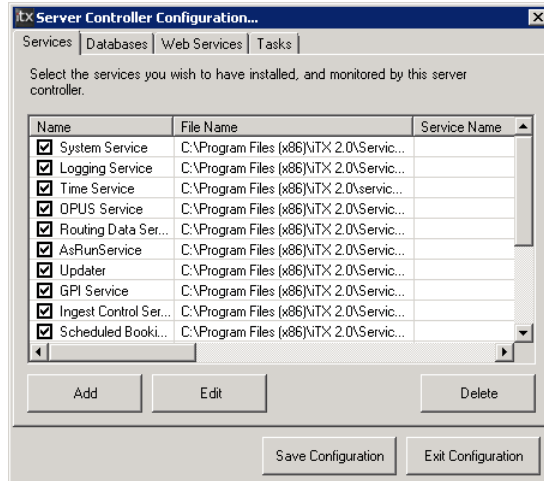

You display the tool by selecting **Server Controller Config** from the iTX group in the Windows Start menu.

The tool has 3 tabs: Services; Databases; Web Services. To modify start-up parameters, you use the features under the Services tab. (You do not need to use the other two tabs for general system administration tasks.)

## Modify start-up parameters

From the Services tab of the Server Controller Configuration tool, you can display the Service Details dialog for any selected service:

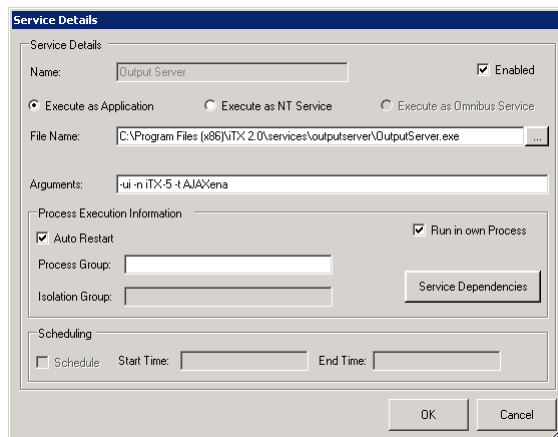

Through this dialog, you can view and edit the settings for the service. These settings include the start-up parameters, which are entered in the **Arguments** box.

1. Select a service under the Services tab of the Server Controller Configuration tool.
2. Click **Edit**.

The Service Details dialog appears and displays the settings for the selected service.

3. Edit the entries in the **Arguments** box to set new start-up parameters. Include a space between any new parameter and the one before it.
4. Click **OK** to close the Service Details dialog.
5. Click **Save Configuration** on the Server Controller Configuration tool.

## Working with the services on the Database Server machine

As well as hosting the System Database, the Database Server machine runs the following system services under the control of a Server Controller.

- The **System Service** combines a number of service roles:
  - As a data service, it has direct access to the System Database. It handles the transfer to and from the database of: service configuration information; iTX Desktop start-up information and layout data; software License information.
  - It maintains the security of the iTX system. In this role, it checks the rights of users who log on at iTX Desktop workstations to use the system resources.
  - It holds a register of alerts – i.e. warnings that it and other iTX services can issue. The warnings relate to potential system conditions that, if they happen, need to be brought to the attention of system administrators or operators.
- The **Logging Service**. All iTX services create logs – records of their actions and responses to system events. The Logging Service collects these logs and stores them in the System Database; it also stores copies on the local drive of the Database Server machine.
- The **OPUS 2 Service** has two main roles:
  - It handles the transfer to and from the System Database of data on all the media files that are available to users in the iTX system.
  - It searches the media data in the System Database. When it finds media items that meet specified criteria, it returns a list of these for iTX to display and operators to select.
- The **Time Service** keeps time for the iTX system. It bases its time on a reference signal from a time source: by default, a VITC generator if there is one in the system; if there is no VITC generator, from the PC clock on the Database Server or an external NTP server.
- The **As-Run Logging Service** stores the details of schedule events that have taken place. From this information, iTX can generate as-run logs.
- The **Routing Data Service** handles the transfer to and from the System Database of routing information (when iTX is set up to operate a matrix router).
- The **Locator Service** keeps a register of the iTX services. When one of these services needs to interact with another, it gets the connection details from the Locator Service.
- The **iTX Software Updater**. [More details](#), page 287.

## Service-window features of iTX services on the Database Server machine

As well as the common service-window tabs that we describe in an earlier section, there are extra tabs for:

- The System Service.
- The Logging Service.
- The OPUS Service.
- The Routing Data Service.



- The Locator Service.

## System Service – Alerts Details tab

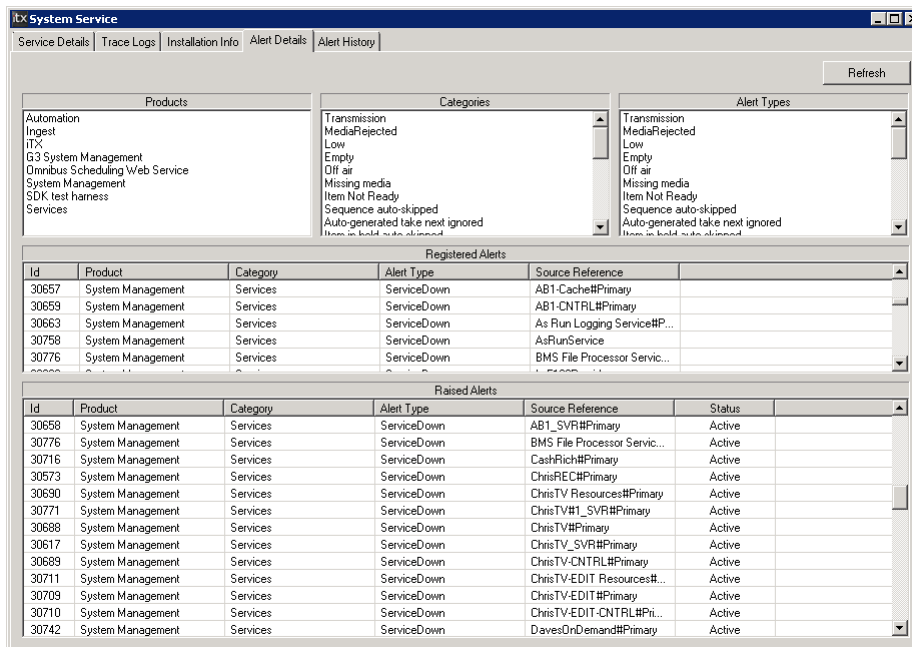

Registered Alerts					
Id	Product	Category	Alert Type	Source Reference	
30657	System Management	Services	ServiceDown	AB1-Cache#Primary	
30659	System Management	Services	ServiceDown	AB1-CNTRL#Primary	
30663	System Management	Services	ServiceDown	As Run Logging Service#P...	
30758	System Management	Services	ServiceDown	AsRunService	
30776	System Management	Services	ServiceDown	BMS File Processor Servic...	

Raised Alerts						
Id	Product	Category	Alert Type	Source Reference	Status	
30658	System Management	Services	ServiceDown	AB1_SVR#Primary	Active	
30776	System Management	Services	ServiceDown	BMS File Processor Servic...	Active	
30716	System Management	Services	ServiceDown	CashRich#Primary	Active	
30573	System Management	Services	ServiceDown	ChrisREC#Primary	Active	
30690	System Management	Services	ServiceDown	ChrisTV_Resources#Primary	Active	
30771	System Management	Services	ServiceDown	ChrisTV#1_SVR#Primary	Active	
30688	System Management	Services	ServiceDown	ChrisTV#Primary	Active	
30617	System Management	Services	ServiceDown	ChrisTV_SVR#Primary	Active	
30689	System Management	Services	ServiceDown	ChrisTV-CNTRL#Primary	Active	
30711	System Management	Services	ServiceDown	ChrisTV-EDIT_Resources#...	Active	
30709	System Management	Services	ServiceDown	ChrisTV-EDIT#Primary	Active	
30710	System Management	Services	ServiceDown	ChrisTV-EDIT-CNTRL#Pri...	Active	
30742	System Management	Services	ServiceDown	DavesOnDemand#Primary	Active	

Under the Alerts Details tab, the System Service provides details of:

- The services (or products) that register alerts.
- The categories into which these alerts are divided.
- The different types of alert.

It also displays two alert lists:

- Alerts that services have registered. The System Service can raise these alerts if the situations that they refer to happen.
- Alerts that are currently active. These are alerts that the System Service has raised, due to certain events happening in the system. Alerts disappear from this list as they clear; this may happen automatically, or as a result of an operator action.

You can update the display by clicking **Refresh**.

### Note:

- You can view the list of active alerts on the Alerts layout at your system-administrator workstation. [More details](#), page 268.

## System Service – Alerts History tab

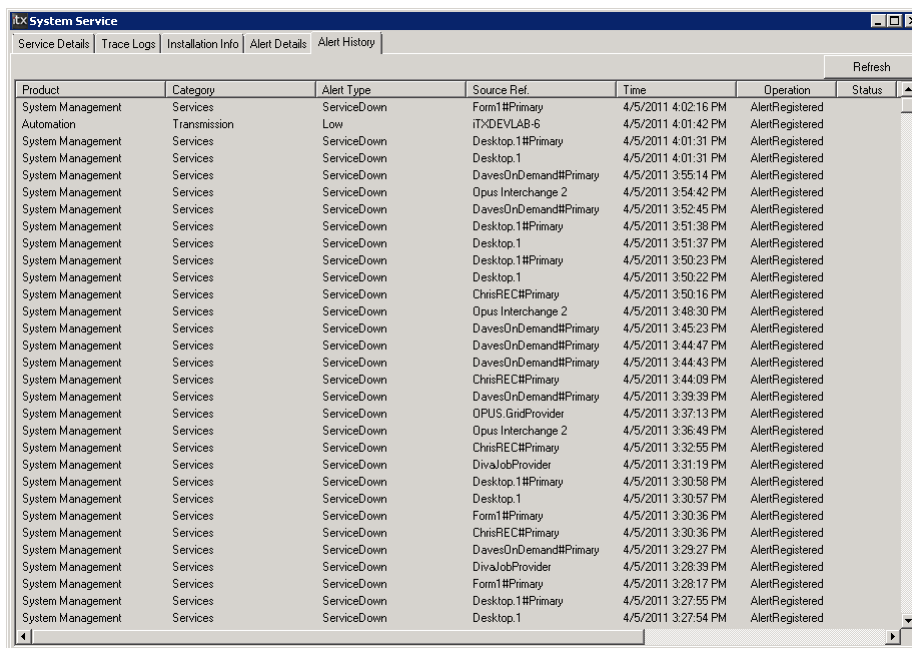

Product	Category	Alert Type	Source Ref.	Time	Operation	Status
System Management	Services	ServiceDown	Form1#Primary	4/5/2011 4:02:16 PM	AlertRegistered	
Automation	Transmission	Low	iTX\DEVLAB-6	4/5/2011 4:01:42 PM	AlertRegistered	
System Management	Services	ServiceDown	Desktop.1#Primary	4/5/2011 4:01:31 PM	AlertRegistered	
System Management	Services	ServiceDown	Desktop.1	4/5/2011 4:01:31 PM	AlertRegistered	
System Management	Services	ServiceDown	DavesOnDemand#Primary	4/5/2011 3:55:14 PM	AlertRegistered	
System Management	Services	ServiceDown	Opus Interchange 2	4/5/2011 3:54:42 PM	AlertRegistered	
System Management	Services	ServiceDown	DavesOnDemand#Primary	4/5/2011 3:52:45 PM	AlertRegistered	
System Management	Services	ServiceDown	Desktop.1#Primary	4/5/2011 3:51:38 PM	AlertRegistered	
System Management	Services	ServiceDown	Desktop.1	4/5/2011 3:51:37 PM	AlertRegistered	
System Management	Services	ServiceDown	Desktop.1#Primary	4/5/2011 3:50:23 PM	AlertRegistered	
System Management	Services	ServiceDown	Desktop.1	4/5/2011 3:50:22 PM	AlertRegistered	
System Management	Services	ServiceDown	ChrisREC#Primary	4/5/2011 3:50:16 PM	AlertRegistered	
System Management	Services	ServiceDown	Opus Interchange 2	4/5/2011 3:48:30 PM	AlertRegistered	
System Management	Services	ServiceDown	DavesOnDemand#Primary	4/5/2011 3:45:23 PM	AlertRegistered	
System Management	Services	ServiceDown	DavesOnDemand#Primary	4/5/2011 3:44:47 PM	AlertRegistered	
System Management	Services	ServiceDown	DavesOnDemand#Primary	4/5/2011 3:44:43 PM	AlertRegistered	
System Management	Services	ServiceDown	ChrisREC#Primary	4/5/2011 3:44:09 PM	AlertRegistered	
System Management	Services	ServiceDown	DavesOnDemand#Primary	4/5/2011 3:39:39 PM	AlertRegistered	
System Management	Services	ServiceDown	OPUS GridProvider	4/5/2011 3:37:13 PM	AlertRegistered	
System Management	Services	ServiceDown	Opus Interchange 2	4/5/2011 3:36:49 PM	AlertRegistered	
System Management	Services	ServiceDown	ChrisREC#Primary	4/5/2011 3:32:55 PM	AlertRegistered	
System Management	Services	ServiceDown	DivalJobProvider	4/5/2011 3:31:19 PM	AlertRegistered	
System Management	Services	ServiceDown	Desktop.1#Primary	4/5/2011 3:30:58 PM	AlertRegistered	
System Management	Services	ServiceDown	Desktop.1	4/5/2011 3:30:57 PM	AlertRegistered	
System Management	Services	ServiceDown	Form1#Primary	4/5/2011 3:30:36 PM	AlertRegistered	
System Management	Services	ServiceDown	ChrisREC#Primary	4/5/2011 3:30:36 PM	AlertRegistered	
System Management	Services	ServiceDown	DavesOnDemand#Primary	4/5/2011 3:29:27 PM	AlertRegistered	
System Management	Services	ServiceDown	DivalJobProvider	4/5/2011 3:28:39 PM	AlertRegistered	
System Management	Services	ServiceDown	Form1#Primary	4/5/2011 3:28:17 PM	AlertRegistered	
System Management	Services	ServiceDown	Desktop.1#Primary	4/5/2011 3:27:55 PM	AlertRegistered	
System Management	Services	ServiceDown	Desktop.1	4/5/2011 3:27:54 PM	AlertRegistered	

Under the Alerts History tab, the System Service displays records for current and recent alerts.

You can update the display by clicking **Refresh**.

## Logging Service – Messages tab

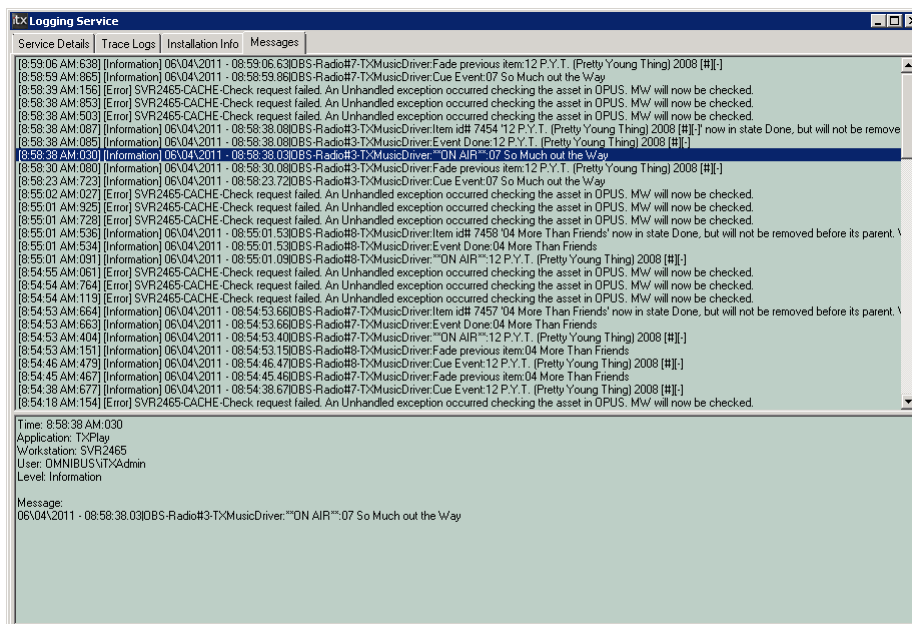

Time	Message
8:59:06 AM:638	[Information] 06/04/2011 - 08:59:06.630DBS-Radio#7-TXMusicDriver:Fade previous item:12 P.Y.T. (Pretty Young Thing) 2008 [#]:
8:58:59 AM:865	[Information] 06/04/2011 - 08:58:59.860DBS-Radio#7-TXMusicDriver:Cue Event:07 So Much out the Way
8:58:39 AM:156	[Error] SVR2465-CACHE-Check request failed. An Unhandled exception occurred checking the asset in OPUS. MW will now be checked.
8:58:38 AM:893	[Error] SVR2465-CACHE-Check request failed. An Unhandled exception occurred checking the asset in OPUS. MW will now be checked.
8:58:38 AM:503	[Error] SVR2465-CACHE-Check request failed. An Unhandled exception occurred checking the asset in OPUS. MW will now be checked.
8:58:38 AM:087	[Information] 06/04/2011 - 08:58:38.080DBS-Radio#3-TXMusicDriver:Item id# 7454 '12 P.Y.T. (Pretty Young Thing) 2008 [#]:] now in state Done, but will not be remove
8:58:38 AM:085	[Information] 06/04/2011 - 08:58:38.080DBS-Radio#3-TXMusicDriver:Event Done:12 P.Y.T. (Pretty Young Thing) 2008 [#]:
8:58:38 AM:080	[Information] 06/04/2011 - 08:58:38.080DBS-Radio#3-TXMusicDriver:ON AIR:07 So Much out the Way
8:58:30 AM:080	[Information] 06/04/2011 - 08:58:30.080DBS-Radio#3-TXMusicDriver:Fade previous item:12 P.Y.T. (Pretty Young Thing) 2008 [#]:
8:58:23 AM:723	[Information] 06/04/2011 - 08:58:23.720DBS-Radio#3-TXMusicDriver:Cue Event:07 So Much out the Way
8:55:02 AM:027	[Error] SVR2465-CACHE-Check request failed. An Unhandled exception occurred checking the asset in OPUS. MW will now be checked.
8:55:01 AM:325	[Error] SVR2465-CACHE-Check request failed. An Unhandled exception occurred checking the asset in OPUS. MW will now be checked.
8:55:01 AM:728	[Error] SVR2465-CACHE-Check request failed. An Unhandled exception occurred checking the asset in OPUS. MW will now be checked.
8:55:01 AM:536	[Information] 06/04/2011 - 08:55:01.530DBS-Radio#8-TXMusicDriver:Item id# 7458 '04 More Than Friends' now in state Done, but will not be removed before its parent.
8:55:01 AM:534	[Information] 06/04/2011 - 08:55:01.530DBS-Radio#8-TXMusicDriver:Event Done:04 More Than Friends
8:55:01 AM:091	[Information] 06/04/2011 - 08:55:01.090DBS-Radio#8-TXMusicDriver:ON AIR:12 P.Y.T. (Pretty Young Thing) 2008 [#]:
8:54:55 AM:061	[Error] SVR2465-CACHE-Check request failed. An Unhandled exception occurred checking the asset in OPUS. MW will now be checked.
8:54:54 AM:764	[Error] SVR2465-CACHE-Check request failed. An Unhandled exception occurred checking the asset in OPUS. MW will now be checked.
8:54:54 AM:115	[Error] SVR2465-CACHE-Check request failed. An Unhandled exception occurred checking the asset in OPUS. MW will now be checked.
8:54:53 AM:664	[Information] 06/04/2011 - 08:54:53.660DBS-Radio#7-TXMusicDriver:Item id# 7457 '04 More Than Friends' now in state Done, but will not be removed before its parent.
8:54:53 AM:663	[Information] 06/04/2011 - 08:54:53.660DBS-Radio#7-TXMusicDriver:Event Done:04 More Than Friends
8:54:53 AM:404	[Information] 06/04/2011 - 08:54:53.400DBS-Radio#7-TXMusicDriver:ON AIR:12 P.Y.T. (Pretty Young Thing) 2008 [#]:
8:54:53 AM:151	[Information] 06/04/2011 - 08:54:53.150DBS-Radio#8-TXMusicDriver:Fade previous item:04 More Than Friends
8:54:46 AM:479	[Information] 06/04/2011 - 08:54:46.470DBS-Radio#8-TXMusicDriver:Cue Event:12 P.Y.T. (Pretty Young Thing) 2008 [#]:
8:54:45 AM:467	[Information] 06/04/2011 - 08:54:45.460DBS-Radio#7-TXMusicDriver:Fade previous item:04 More Than Friends
8:54:38 AM:677	[Information] 06/04/2011 - 08:54:38.670DBS-Radio#7-TXMusicDriver:Cue Event:12 P.Y.T. (Pretty Young Thing) 2008 [#]:
8:54:18 AM:154	[Error] SVR2465-CACHE-Check request failed. An Unhandled exception occurred checking the asset in OPUS. MW will now be checked.

Time: 8:58:38 AM:030  
 Application: iTXPlay  
 Workstation: SVR2465  
 User: OMNIBUS\iTX\Admin  
 Level: Information

Message:  
 06/04/2011 - 08:58:38 030DBS-Radio#3-TXMusicDriver:ON AIR:07 So Much out the Way

All iTX services generate log messages, which they send to the Logging Service to manage. Each day, the Logging Service creates a single file containing all the log messages it receives on that day. It stores the file in a folder on the Database Server. The path of the folder is typically:

C:\Users\username\AppData\Roaming\iTX\LoggingService3.5\System Logs

To prevent the log files taking up too much disk space, the Logging Service overwrites each one with the log file for the same day of a following month.

Under the Messages tab, the Logging Service displays log messages as it processes them. It displays this information in two panes: in the upper pane, log lines (brief descriptions of the conditions or events the messages relate to); in the lower pane, full details for any selected log line.

**Note:**

- You can view the list of log messages on the Logging layout at your system-administrator workstation. [More details](#), page 268.

## OPUS Service – Management, Control tab:

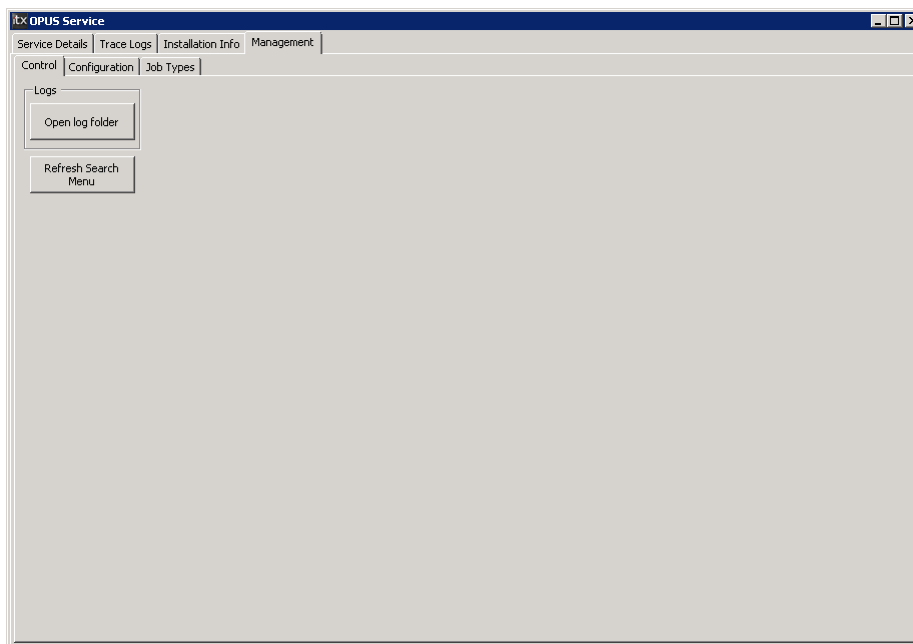

The Management, Control tab has two buttons:

- Clicking **Open log folder** opens the folder in which the service stores logs.
- Clicking **Refresh Search Menu** resets the PinPoint search menu to its default appearance.

## OPUS Service – Management, Configuration tab:

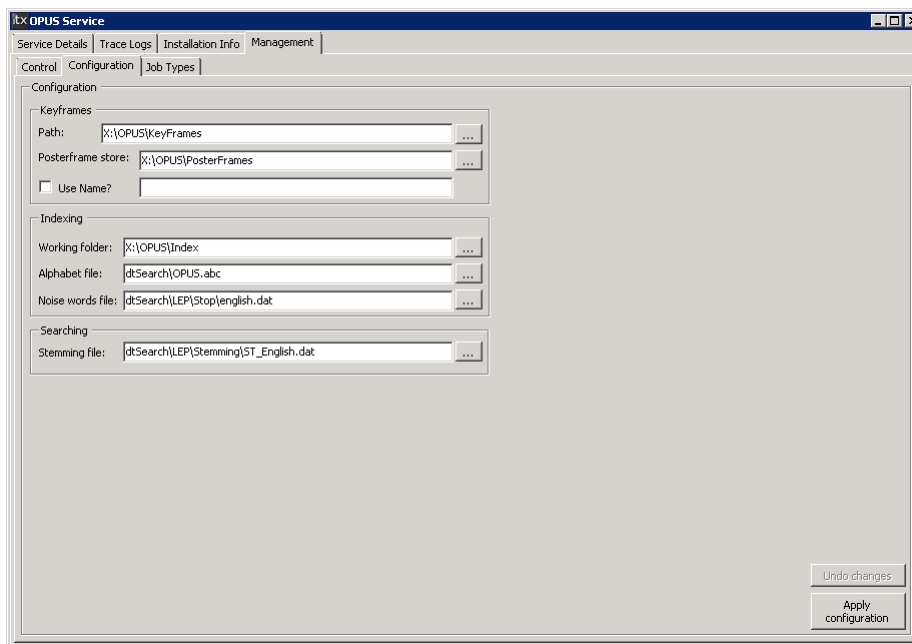

Under the Management, Configuration tab, the service displays its configuration. You may edit this, before clicking **Apply Configuration**; the new configuration takes effect when you restart the service.

## OPUS Service – Management, Job Types tab:

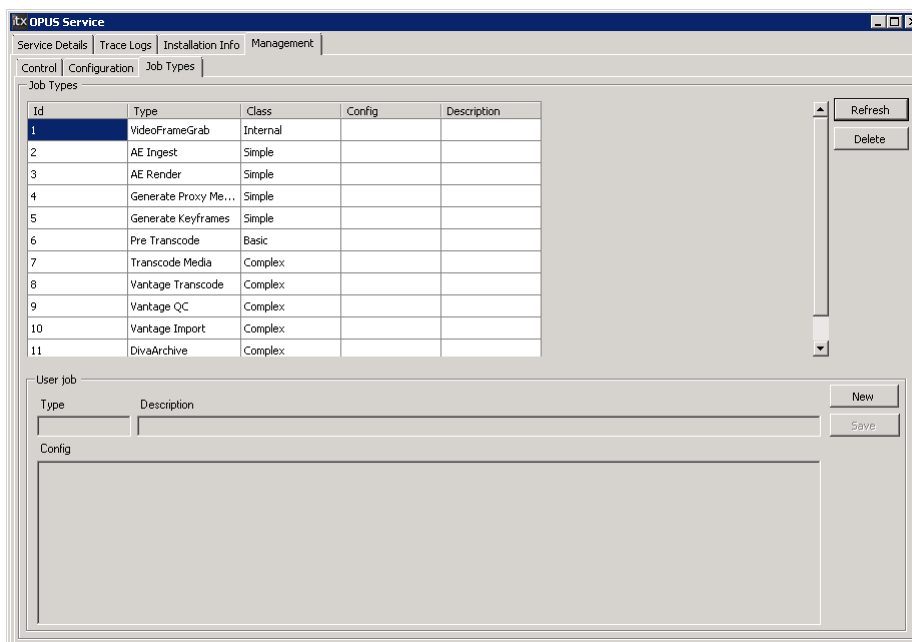

Under the Management, Job Types tab, the service displays a list of workflow job types.

## Routing Data Service – Matrix Details tab:

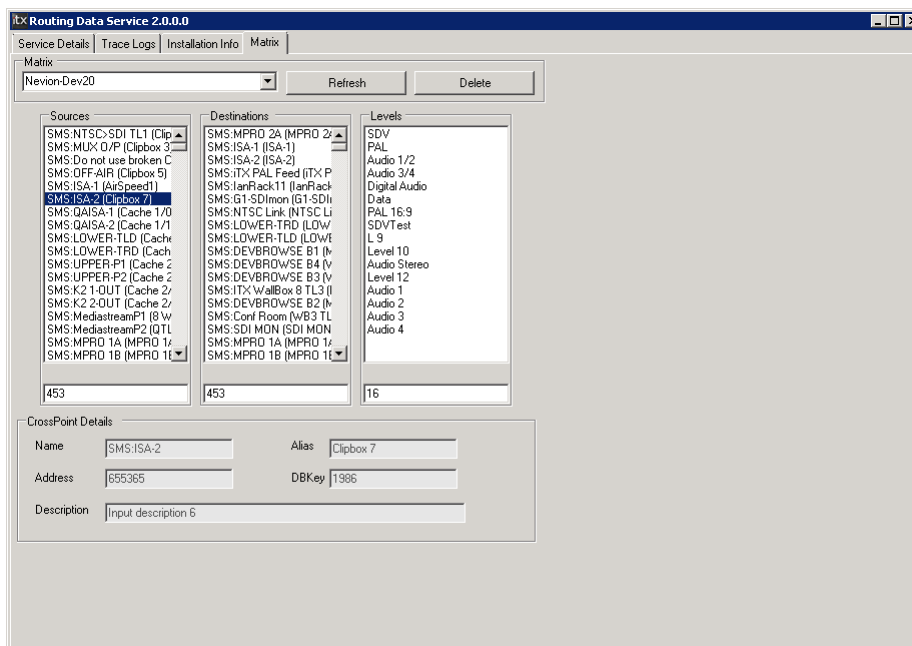

Under the Matrix Details tab, you can view the crosspoint details that are stored in the System Database for all the matrix routers that iTX can control.

There are two buttons under the tab:

- Clicking **Refresh** updates the displayed details for the router-control service selected in the **Matrix** box. The Routing Data Service copies the information from the System Database.
- Clicking **Delete** causes the Routing Data Service to delete from the System Database all the information for the router-control service selected in the **Matrix** box.

## Locator Service – Services tab

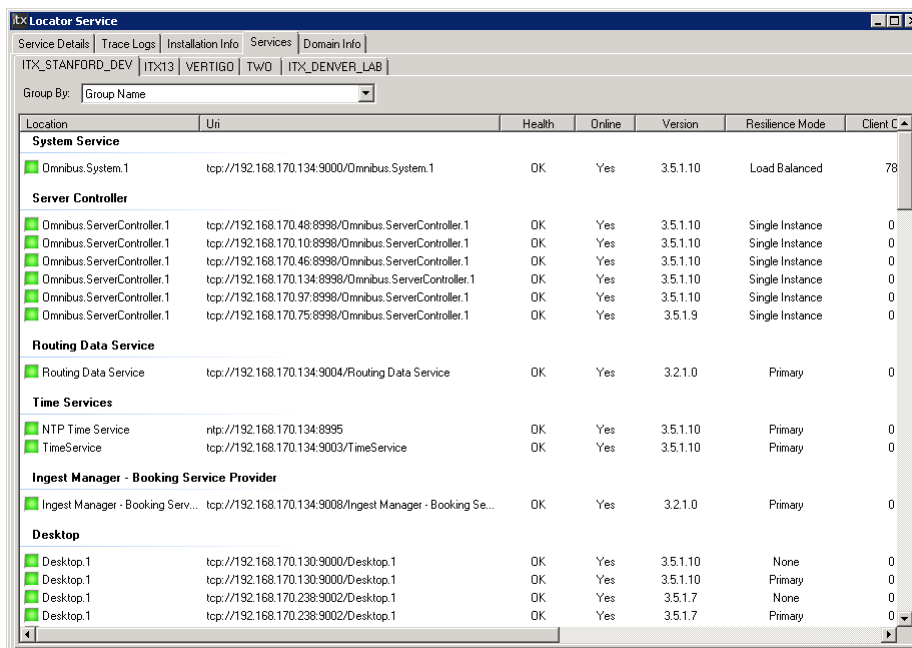

Location	Uri	Health	Online	Version	Resilience Mode	Client C
<b>System Service</b>						
■ Omnibus System.1	tcp://192.168.170.134:9000/Omnibus.System.1	OK	Yes	3.5.1.10	Load Balanced	78
<b>Server Controller</b>						
■ Omnibus.ServerController.1	tcp://192.168.170.48:8998/Omnibus.ServerController.1	OK	Yes	3.5.1.10	Single Instance	0
■ Omnibus.ServerController.1	tcp://192.168.170.10:8998/Omnibus.ServerController.1	OK	Yes	3.5.1.10	Single Instance	0
■ Omnibus.ServerController.1	tcp://192.168.170.46:8998/Omnibus.ServerController.1	OK	Yes	3.5.1.10	Single Instance	0
■ Omnibus.ServerController.1	tcp://192.168.170.134:8998/Omnibus.ServerController.1	OK	Yes	3.5.1.10	Single Instance	0
■ Omnibus.ServerController.1	tcp://192.168.170.97:8998/Omnibus.ServerController.1	OK	Yes	3.5.1.10	Single Instance	0
■ Omnibus.ServerController.1	tcp://192.168.170.75:8998/Omnibus.ServerController.1	OK	Yes	3.5.1.9	Single Instance	0
<b>Routing Data Service</b>						
■ Routing Data Service	tcp://192.168.170.134:9004/Routing Data Service	OK	Yes	3.2.1.0	Primary	0
<b>Time Services</b>						
■ NTP Time Service	nntp://192.168.170.134:8995	OK	Yes	3.5.1.10	Primary	0
■ TimeService	tcp://192.168.170.134:9003/TimeService	OK	Yes	3.5.1.10	Primary	0
<b>Ingest Manager - Booking Service Provider</b>						
■ Ingest Manager - Booking Serv...	tcp://192.168.170.134:9008/Ingest Manager - Booking Se...	OK	Yes	3.2.1.0	Primary	0
<b>Desktop</b>						
■ Desktop.1	tcp://192.168.170.130:9000/Desktop.1	OK	Yes	3.5.1.10	None	0
■ Desktop.1	tcp://192.168.170.130:9000/Desktop.1	OK	Yes	3.5.1.10	Primary	0
■ Desktop.1	tcp://192.168.170.238:9002/Desktop.1	OK	Yes	3.5.1.7	None	0
■ Desktop.1	tcp://192.168.170.238:9002/Desktop.1	OK	Yes	3.5.1.7	Primary	0

The list under the Services tab provides details of iTX services and clients that are registered with the Locator Service. The services are arranged in groups, depending on a specified attribute. You can select the way in which groups are formed by selecting an option in the **Group By** box:

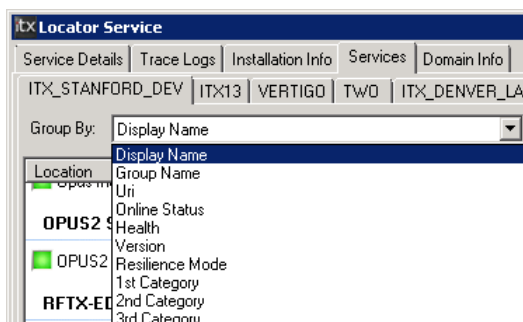

A service-status indicator to the left of an entry shows the status of the associated service. Resting your mouse pointer over the indicator displays a pop-up window containing service details:

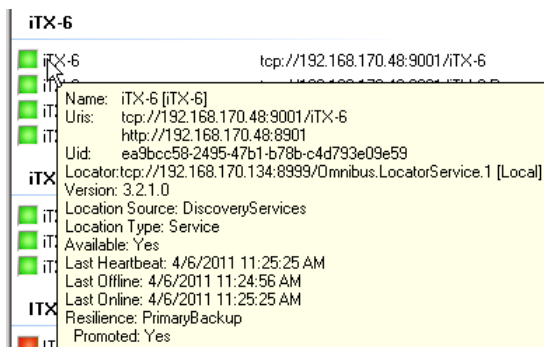

Double-clicking the indicator displays the Service Provider Status dialog for the service. From this, you can run a simple diagnostics test and view a test report. [More details](#), page 98.

In some cases, the list includes individual components that make up a complete service. This illustration shows 3 components for both TXPlay and TXEdit (along with the Output Server that interacts with TXPlay):

iTX-6		
 iTX-6	tcp://192.168.170.48:9001/iTX-6	} TXPlay and Output Server
 iTX-6 Resources	tcp://192.168.170.48:9001/iTX-6 Resources	
 iTX-6_SVR	tcp://192.168.170.48:9002/iTX-6_SVR	
 iTX-6-CNTRL	tcp://192.168.170.48:9001/iTX-6-CNTRL	
iTX-6-EDIT		
 iTX-6-EDIT	tcp://192.168.170.48:9000/iTX-6-EDIT	} TXEdit
 iTX-6-EDIT Resources	tcp://192.168.170.48:9000/iTX-6-EDIT Resources	
 iTX-6-EDIT-CNTRL	tcp://192.168.170.48:9000/iTX-6-EDIT-CNTRL	

You can save the Services list in a CSV (comma-delimited) file by right-clicking the list and selecting **Export service list to CSV file**.

In a multi-domain system, service lists for other domains appear under their own sub-tabs under the Service tab.

## Locator Service – Domain Info tab

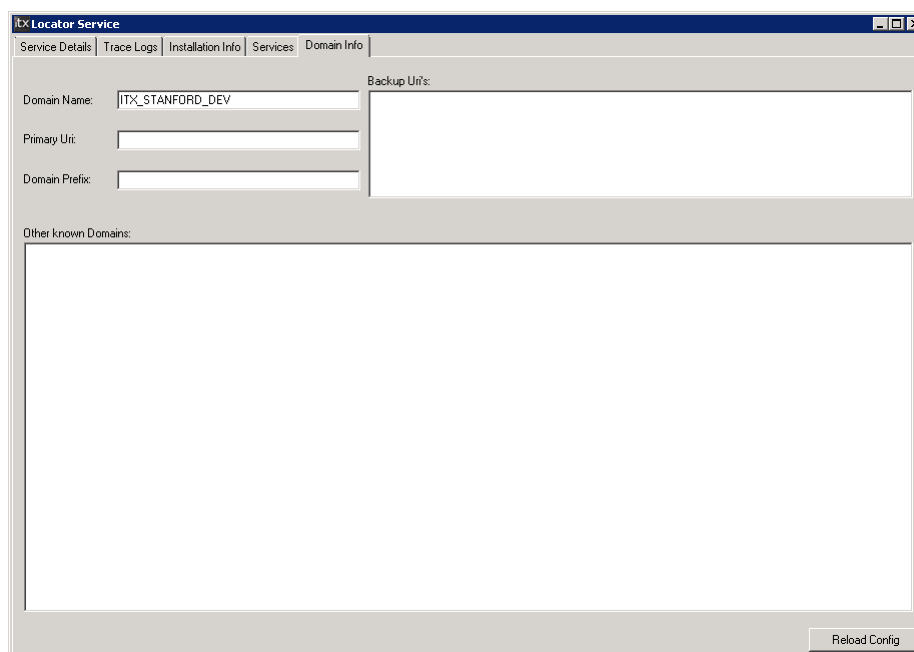

Under the Domain Info tab, the Locator Service gives details about network domains and back-up Locator Services.

# Working with the Media Watcher

An iTX system must have a Media Watcher to manage the Media Store. It may have additional Media Watchers to manage multiple Media Stores.

The Media Watcher performs these tasks:

- It provides the main way of ingesting media files into iTX. To do so, it controls the copying of existing media files onto a Media Store and registers these files in the System Database.
- It registers, in the System Database, files that an Encode Server creates in recording digital video content from a videotape, video server or live feed.
- It registers, in the System Database, media that exists on an external Media Store, such as a video server.
- It responds to requests from a Media Cache Service to copy media files from an external search folder. Depending on the search-folder configuration, it may copy the files to either a Media Store or an Output Server cache.
- It enters in the System Database the code contained in software License files, to release the functionality contained in software plug-ins.

The Media Watcher can handle media files distributed across multiple network volumes.

## Copying and registering files

The Media Watcher monitors a special folder, called the Inbox, on a Media Store. When a media file is placed in the Inbox, the Media Watcher performs two tasks:

- It checks the file is in a valid format and registers it – it reads the file property information (filename, size, etc.) and copies this information to an asset (database record), which it creates for the file in the System Database.
- It moves the file to a folder inside the Media folder on the Media Store. In doing this, it adds a suffix to the filename: "\_OMN" followed by a 10-digit number based on the date and time of registration.



In the Media folder, the Media Watcher creates different subfolders for different media types (AVI video clips, MPG video clips, CGs, etc.) as shown in this illustration:

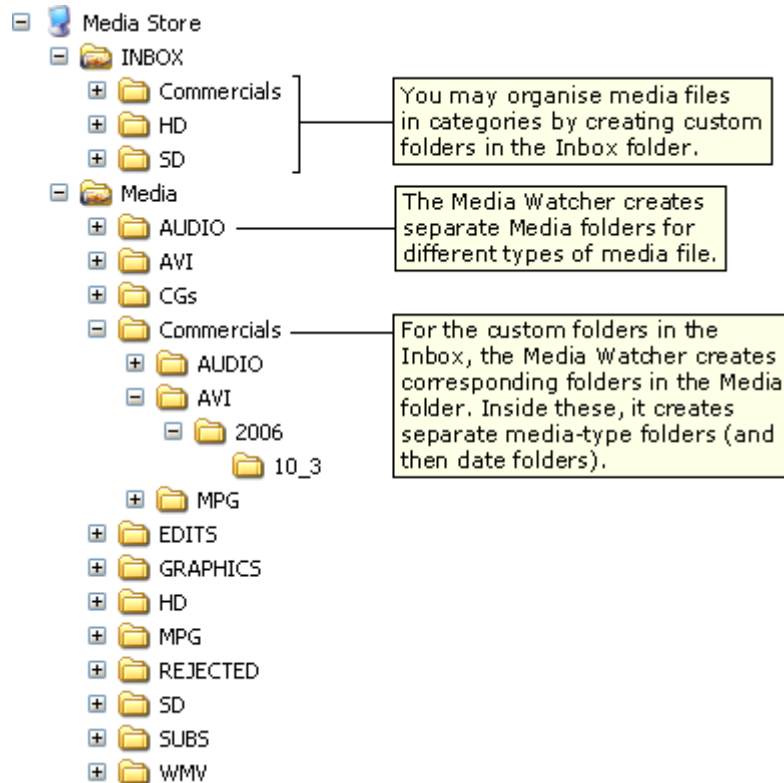

In the Inbox, you may create custom folders for organising media files into categories; for example, commercials, HD video clips, SD video clips. The Media Watcher creates matching custom folders within the Media folder. For each case, it does this the first time a media file is placed in an Inbox custom folder.

#### Important:

- The Media Watcher must not be running when you create a custom folder in the Inbox.

When a media file is placed in a custom folder in the Inbox, the Media Watcher registers it and moves it to the corresponding custom folder in the Media folder; it places the file in a subfolder of this, depending on the media type and the date on which it performs this task.

If a file in the Inbox is not in a valid format, the Media Watcher moves it to a Rejected folder without registering any details in the System Database.

## Clip Templates

When the Media Watcher registers a media file, it assigns a set of properties to the asset that it creates in the System Database; for example, it specifies an aspect-ratio for a video clip. It copies these properties from a default clip template, which it uses to create the media item; it uses different templates for SD and HD video clips.

You specify default clip templates when you configure the Media Watcher. [More details](#), page 90.

You can set up the Media Watcher to use a clip template other than one of the default ones for certain video clips. For this, you create a clip template on the Asset layout; and you create a custom folder with the same name as the clip template in the Inbox. When a media file is

placed in the custom folder, the Media Watcher applies the matching clip template to the asset it creates for the file.

An Asset template can contain asset-level metadata which will be applied to an asset or media file on registration in order to save manual effort during asset management process. Asset metadata associated with a Clip Template is added in the same way you would add metadata to a registered piece of media, by loading the template in the Asset layout and editing the metadata properties as you would a clip.

## Re-ingesting files

If a media file placed in the Inbox has the same filename as a media file that is already registered in the system, iTX replaces the existing file with the new one. It deletes the old media file from all locations (Media Store, Output Server caches, and archive). If the old media file is being used in an on-air event, iTX deletes it after the event finishes.

An exception to this is if there are multiple assets (co-references) associated with the media file. The Media Watcher then does not delete the old one; instead, it moves the new media file to the Rejected folder.

If you want the Media Watcher to accept the new media file, you must first delete the extra media items (daughter clips).

### Note:

- If both the duration and filename of a new media file are the same as those of a file for which there is an existing media item (for example, when the media location is an archive or videotape), the Media Watcher registers the new media file with the same in- and out-points that are stored in the media item.

## Valid formats for media files and other types of file

In general, the Media Watcher can handle files of the types identified by the filename extensions listed below.

However, you should use this information as a guide only. To check if the Media Watcher can register a media file in a particular format, contact iTX Support. It may be necessary to provide sample files for testing.

### Video

.avi; .gxf; .mov; .mpg; .mpeg; .mxf; .saf; ts; m2v

.wmv (only when the Media Watcher runs on a Windows Server 2003 operating system)

### Audio

.mp3; .wav; .wma

Additionally, with the Music MW Import plug-in:

.aac; .aif; .aiff; bwf; .m1a; .m2a; .m4a; .mp1; .mp2; .mp3pro; .mpa; .mu; .ogg

### Still image

.bmp; .jpg; .jpeg; .png; .tif; .tiff

.tga (single frame in .tzip file – see later in this section)

**Animated images**

.tzip (animated logo sequences with .tga, .png or .tif files); .spg (an iTX format); 3Dzip (graphics scripts)

**iTX CG**

.cap

**Closed captions**

.scc

**Text-based formats**

.csv; .stl; .subs; .vbi; .xml; .xtl

**License**

.lic

**iTX Import Protocol**

.ocl; .osc; .wpl

**Archive files** (for iTX installation packages)

.zip

**iTX Desktop layout**

.dtp

**iTX schedule**

.sched2

**Note:**

- iTX CG files may include text with characters from any OpenType font that is installed on an iTX Desktop workstation. The font must also be installed on any Output Server that is to play out the CG.
- The Media Watcher converts .bmp files to .png files before registering them. This is to reduce their file size (without loss of quality) and so make them easier for iTX to process during playout.
- iTX displays the images in an animated sequence at the frame rate of the playout channel.
- The Media Watcher can accept Pro-Bel schedules. For more information, contact iTX Support.
- When the Media Watcher registers a .mov or .mxf file from an Omneon video server, it uses the timecode information in media-file metadata (information linked to the clip) to set the in-point and out-point in the asset.
- The Media Watcher can accept some video files (GXF, MPEG-2 and files encoded using an Omneon video server) with external subtitles (closed captions) in media-file metadata.
- Video files may have standard-definition (SD) EIA-608 or high-definition (HD) EIA-708 external subtitles (closed captions) inserted in the video signal.
- The Media Watcher does not import files that have DRM (Digital Rights Management) protection.

## Animated sequences and their different playout modes

An animated sequence is a set of image files in a specified format (.tga, .png or .tif) that make up the frames in an animation. It may be used as an animated logo or as a background in a CG. It cannot be used in DVEs, as a CG layer element or as an off-air slide.

So that the Media Watcher can process the sequence, you need to package the image files in a Zip-type archive and rename the filename extension to ".tzip"; you then place the .tzip file in the Inbox.

On importing an animated sequence, the Media Watcher creates a single file, registers it and places it on the Media Store; the new file has the same name as the .tzip archive and the filename extension ".spg". In creating the file, the Media Watcher sorts the images in ascending order of filename (i.e. from 0 to 9 and A to Z) and by reading numbers as part of the text. So, for example, if a sequence contains the image files IMG1, IMG11 and IMG100, these play out in the order IMG1, IMG100, IMG11.

You should ensure the image filenames are such that the Media Watcher arranges the images into the correct playout order; if necessary, insert 0s before a number. For example: IMG001, IMG002, IMG003 ... IMG009, IMG010, IMG011 ... IMG099, IMG100, IMG101.

In the .tzip file, the image files should be at the top level – not stored in folders.

iTX calculates a default duration for each imported sequence, based on the number of images it contains and the output frame rate (PAL or NTSCdf). When importing .spg files from another iTX system, it assigns a default duration of 30 seconds to these.

There are three basic playout modes for an animated sequence:

- Loop. iTX repeats – or *loops* – the sequence for the duration of the logo event.
- Freeze. iTX plays the sequence once and then holds the last frame on a freeze.
- Once. iTX plays the sequence once and then removes it from the screen.

You specify an operating mode by including a text file, called "mode.txt", in the top level of the sequence archive. The text file needs to contain a single word – LOOP, FREEZE or ONCE – that corresponds to one of the modes. If an archive does not contain the text file, iTX applies the loop mode by default.

To help operators to know how an animation is going to play out, we recommend you use a naming system that makes it possible to deduce playout modes from filenames.

iTX can also play out an animated sequence in a more complex mode, to include an internal loop. For this mode, you define three sections: the in-section, the loop, and the out-section. iTX plays out the in-section once, the internal loop a complete number of times, and the out-section once; it then removes the animation.

The number of loops is determined by the duration that is set for the animation. iTX always completes the last loop before playing out the out-section. If it cannot complete a whole number of loops, together with the full in- and out-sections, in a time that exactly matches the duration, it plays just as many full loops as it can before the out-section. Because of this, an animation may play for slightly less time than its specified duration.

For the complex mode, you need to include a modified mode.txt file in the archive. In this file, you start with the command "ANIMATE"; you then specify the start and end frames for each section.

Example:

```

ANIMATE
IN_START 1
IN_END 75
LOOP_START 76
LOOP_END 175
OUT_START 176
OUT_END 250

```

For an animation in which all the frames after the first section are looped, you only need to specify the start of the loop:

```

ANIMATE
LOOP_START 76

```

An operator can schedule animated sequences from the Logo palette, which appears in the Content Selector on the Channel Control layout.

## Importing a single TARGA frame for use as a logo

The Media Watcher can import a single TARGA frame in the same way it imports animated sequences.

You need to place a .tzip file containing the TARGA frame in the Inbox; the .tzip file should also include a mode.txt file specifying the Freeze playout mode.

See the previous topic, "Animated sequences and their different playout modes".

## Registering of reference MOV and MXF files

For the Media Watcher to register reference MOV and MXF files, you create a custom folder, "\_ESSENCE", and a subfolder, "media.dir", in the Inbox.

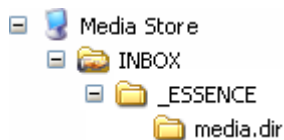

The video and audio essence files, along with any associated .scc or .stl file containing the external subtitle (closed-caption) data, are placed in the media.dir subfolder. After this, the reference file is placed in the \_ESSENCE subfolder of the Inbox.

The Media Watcher registers the reference file and moves it to a folder depending on the media type and the date on which it performs the task. The folder sequence is: clip storage format (e.g. MXF); current year; today's date (US format).

On registering the essence files, the Media Watcher moves the files into the essence subfolder of the date subfolder, named according to the filename followed by "\_OMN", a 10 digit number and "\_ESSENCE".

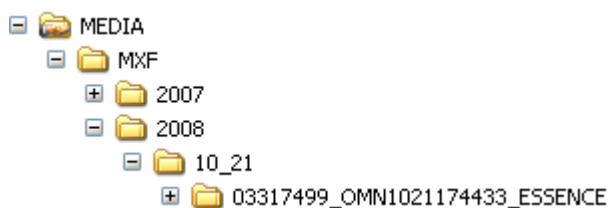

## Registering of recordings

The Encode Server running on an Encode Server machine manages the recording of SDI video into the iTX system. In recording the media, the service creates a media file directly in the Media folder and places an XML registration file, containing the recording details, in the Inbox.

After copying the information from the registration file to the System Database, the Media Watcher deletes this file.

## Registering of media on an external Media Store

An external Media Store is an additional storage device containing media files that have not passed through the Inbox (and so are not on an iTX Media Store).

To allow iTX to use these files, you may register them by placing an XML registration file, containing the details of all the media files on the external device, in the Inbox. The file must be in the clip-list format defined by the iTX Import Protocol. (The protocol defines formats for schedules and clip lists.) Clip-list files in this format have the filename extension ".ocl"; the filename may contain up to 32 characters.

The Media Watcher copies the information from the registration file to the System Database, and then deletes this file.

When a file on an external Media Store is required for playout, iTX may copy it to a Media Store in the main iTX system; or it may use the file direct from the external Media Store. The operating mode depends on how you configure the Media Watcher to work with the external Media Store. [More details](#), page 74.

For more information about the iTX Import Protocol, contact iTX Support.

## Copying of media files for playout

To produce the best playout performance, an Output Server machine holds a cache of media files that are due to play out in a schedule. The Media Cache Service, on this machine, maintains the cache by deleting files that are not needed and using the Output Server to add ones that are.

Where a required file is in a Media Watcher search folder, the Media Cache Service can use the Media Watcher to copy the file either to an iTX Media Store or the Output Server cache. You configure search folders under the Setup tab of the Media Watcher service window. [More details](#), page 74.

**Note:**

- To be able to manage the copying of media files to an Output Server cache, the Media Watcher must have network access rights to the Media folder on the Cache volume of the Output Server.

## Registering of Licenses

For the scheduling services (TXPlay and TXEdit) on any Output Server machine to operate, the machine must have a License dongle fitted and the License must be registered in the System Database. The same applies for the Encode Server on an Encode Server machine.

The Media Watcher registers Licenses by copying the information stored in License files, placed in the Inbox folder, to the System Database.

**Note:**

- The iTX system software includes a variety of optional services. Some of these services are only available if your system has the necessary software Licenses; e.g. the Missing Materials Manager, the XML Adaptor.

## Deleting files

The OPUS Service handles all requests to delete assets from the System Database. The Media Watcher responds to asset deletions by deleting files when they are not referenced by any asset.

Sometimes, the Media Watcher cannot immediately delete a file – for example, when the file is locked, or loaded in a Preview Window. In such a case, the Media Watcher creates a text file with a .DEL extension in the Inbox. It continues to try to delete the file. If you restart the Media Watcher before it completes this task, the .DEL file causes it to retry the deletion until it is successful.

## Extra service-window features for the Media Watcher

As well as the common service-window tabs that we describe in an earlier section, the Media Watcher window displays extra tabs.

### Media Watcher – Setup tab

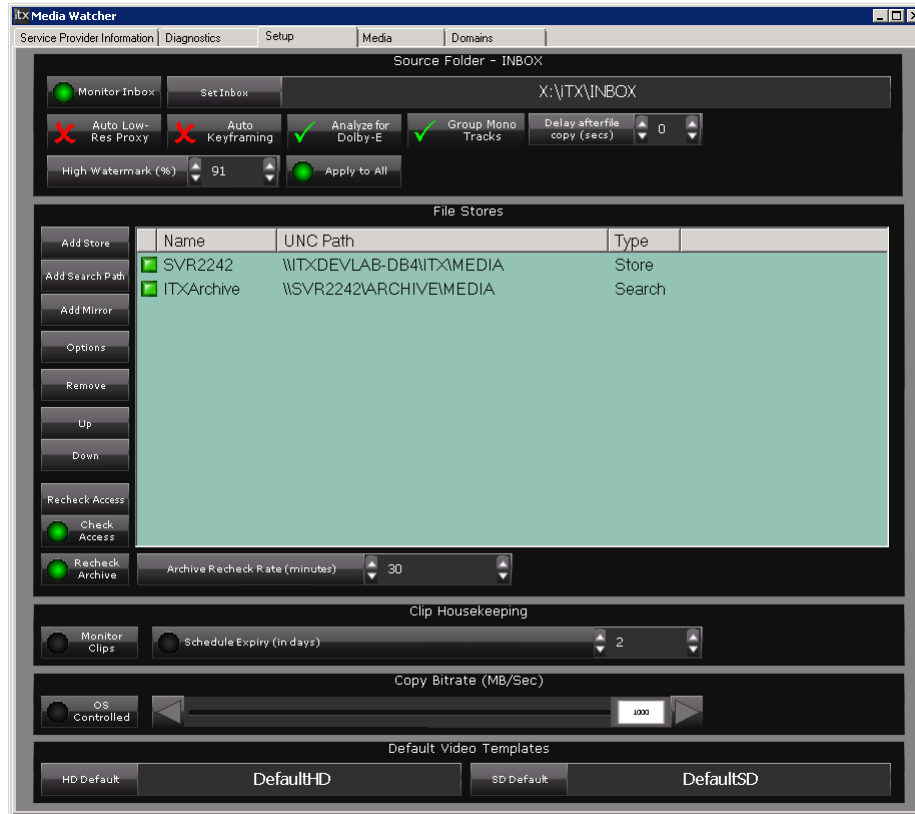

Under the Setup tab are features that you use to configure the Media Watcher. For instructions on how to do this, see the separate section: "Configuring a Media Watcher", page 73.



## Media Watcher – Media tab

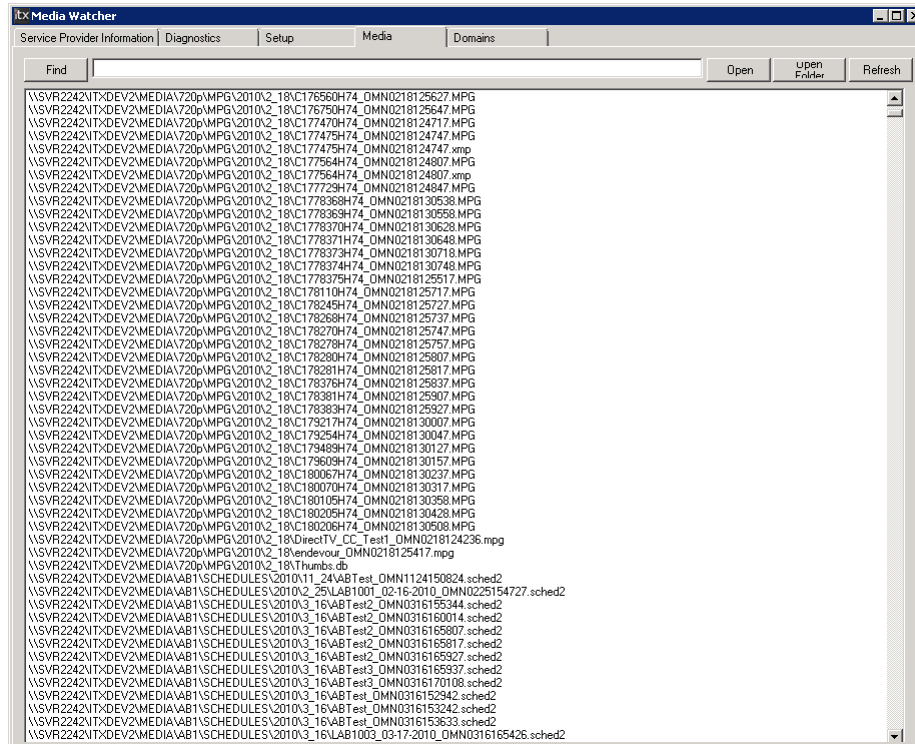

The Media Watcher reads the directories of all the folders in the Media Folders list (under the Setup tab). It displays a list of all the files in these folders under the Media tab, whether or not the files are registered.

You may update the list by clicking **Refresh**.

After selecting a file in the list, you may click **Open** to open the file in a suitable application; or **Open Folder** to open the folder that contains the file.

You may quickly find a file in the list by entering its name or part of its name in the search box (above the list) and clicking **Find**.

## Media Watcher – Domains tab

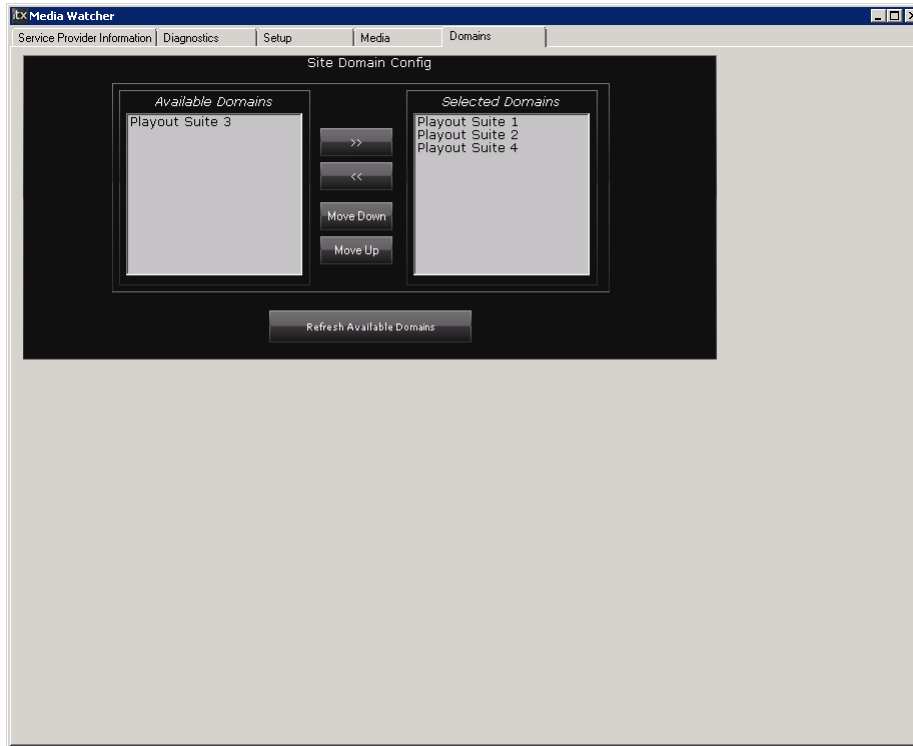

## Alternative Workflow-driven media imports

The Workflow service can be used as alternative method of media registration in iTX. The Media Import Workflow speeds up file registration and can use a special media analysis tool after initial registration to extract more metadata and information about the file. This is referred to as Deep Analysis.

The same tool, known within iTX as FPP can also be used to register certain types of media instead of the usual method deployed by the Media Watcher.

FPP is currently the only method by which iTX can import LXF and AVC-Intra MXFs. This is set by default in iTX upon installation, but a special configuration tool can be used to assign the registration of other media type to FPP. For further information, please see the section **Media Import Configuration Tool** below

When a file is imported, the Delivery Manager must read through then analyse the whole file in order to extract accurate information about the clip's duration etc. This can be time consuming, especially on long play or large hi-res media files.

Importing using the Workflow Services allows quicker registration because analysis of the new media is broken down into two phases. A quick analysis takes place first allowing the clip and its basic details to be registered in the iTX Database rapidly. This is done by placing the media in a configured 'watch folder' much the same as Media Watcher's Inbox and the Media Import Workflow reacts to new files placed in this folder.

A separate Workflow is then triggered following initial registration to allow the Deep Analysis of the media. Media Import Workflow can move to the next file that requires registration. The database is then updated with the further information on the new Media Asset when the second phase of registration is complete.

The types of information extracted can be configured in the workflow itself and could be such things as Field order, the AFD information stored in the VANC and whether the clip has Dolby digital audio etc.

**Note:** The Workflow Service along with the associated workflows require a licence to register media in this way.

Please see the section on [Workflow \(page 377\)](#) and also the Grass Valley iTX Workflow User Guide for further details.

# Media Import Configuration Tool

**NOTE:** Use of this tool can have a major impact on the functionality of your iTX system and therefore **MUST ONLY BE DEPLOYED BY AN EXPERIENCED ITX SYSTEM ADMINISTRATOR OR GRASS VALLEY ITX SUPPORT ENGINEER.**

As mentioned in the previous section there are now two mechanisms that can be used to register media and its associated metadata in ITX. The standard method used by the Delivery Manager(MU registration mode) and an alternative method (FPP) that allows for 'Deep Analysis' of the media.

**By default, iTX uses the standard MU mode for all media types, with the exception of LXF and AVC-Intra MXF files, which use the FPP mode.**

Because Deep Analysis cannot be performed in the standard mode, you may wish to override which media types are registered by which method, depending on your registration data and metadata requirements.

This can be done via the Media Import Configuration Tool. It facilitates manual configuration of global overrides that are applicable to iTX Desktop, Preview and Playout and local override configurations on a specific instance of an application via an XML configuration file.

Global overrides are applied to both Import and Output of media files, i.e. both registration and playout. Local overrides will only change which of the two methods are used to parse the media on playback on an output server.

## Installation

The Media Import Configuration Tool is installed via the main iTX Installer. When prompted to Select Software (see iTX Installation Instructions page xxx) expand the Utilities tree and select Import Configuration Tool:

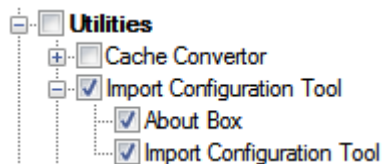

This installs the tool to the location:

C:\Program Files\iTX 2.0\Applications\ImportConfigurationTool

**NOTE:** Because of the potential system wide implications of using this tool, unlike the rest of the iTX software, it does NOT show up in the Windows Program Files menu, so a user must navigate manually to this path and double click **Omnibus.OPUS.Import.ConfigurationTool.exe** in order to run it.

## Usage

Once run up, the Media Import Configuration Tool user interface looks like this:

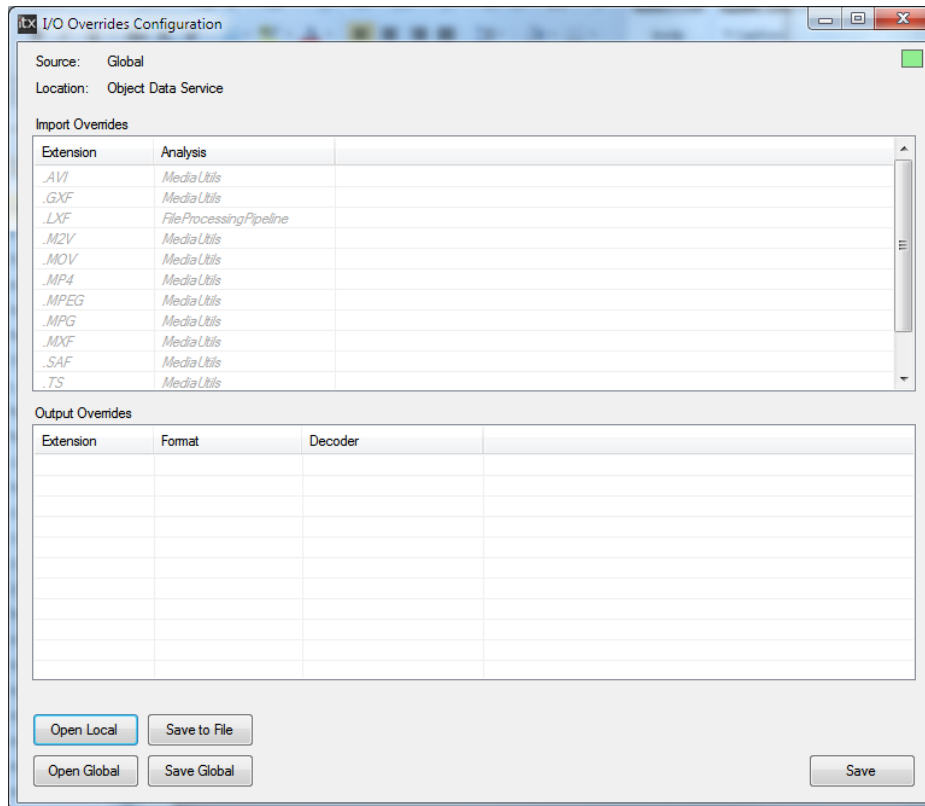

By default, the tool is set to edit the GLOBAL configuration for that format as stored by the Object Data Service.

### Import Overrides (media registration)

In the Import Overrides section, if the analysis type for an extension has not been overridden, the entry will be displayed in italics.

If the analysis type for an extension is overridden, the entry will be displayed in non-italicised text.

Right click in the list of file types to change the analysis setting. A pop-up selector then allows you to choose between MU and FPP modes for the selected file type. Click OK when you've made your selection.

### Output Overrides (Playout)

No defaults are shown in the Output Overrides section. If no output override is defined for a file type, it is assumed to be the same as the Import Override setting.

Right-clicking in the Output Overrides section allows you to add a file type to the list and specify which decoder you wish to use when playout that file type.

## Local Overrides

You can also change the settings 'locally' for individual applications that use the OPUS.Import library as they will attempt to load their settings from a local config first.

By default, the configuration file does not exist and will need to be created. The simplest way to create a file with local overrides would be to edit Global settings then click 'Save to File'.

The name of the local config must be 'Omnibus.OPUS.Import.IOConfig.xml'. This should be saved in the folder that the executing application is in. In the case of an Output Server, this would be the TX Play folder.

You can also re-edit the local override settings. Click Open Local and browse to the Omnibus.OPUS.Import.IOConfig.xml you wish to edit. Click Open again and the settings in that file are loaded into the configuration tool. When you have changed the settings you wish to override, click Save to File and the new configuration is written back into the xml file.

If you no longer wish for an application to use any local overrides, simply delete the configuration file and restart the application.

## Working with iTX services on an Output Server machine

The Output Server machine runs a number of interacting iTX services under the control of a Server Controller:

- **TXPlay** manages live schedules. It notes the start times of events with fixed start times; it calculates the start times of other (automatic) events. It sends commands through the Output Server to the iTX Player to play out events at the specified times.
- The **Output Server** passes playout commands to the iTX Player from TXPlay; also from iTX Desktop components, for live logos and CGs.

In the media-caching process, the Output Server responds to cache requests from the Media Cache Service to copy media files from an iTX Media Store to the Output Server cache.

- The **iTX Player** responds to TXPlay commands to play out media files and live video feeds through an SDI video card. In the process, it performs any required video and audio mixing operations.

It gets media files from the Output Server cache.

If a required media file is not in the cache, TXPlay supplies details of the Media Store location of the file; the iTX Player then plays out the media file from that location.

- The **Media Cache Service** maintains the Output Server cache. It sends cache requests to the Output Server so that media files are in the cache when they are due to play out.
- **TXEdit** manages offline schedules. It performs the same scheduling functions as TXPlay, but does not send playout commands to the Output Server.
- The **iTX Software Updater**. [More details](#), page 287.

For the transmission of live news programmes, an extra service may run on the Output Server machine:

- **TXLive** plays out schedule events under manual control. Like TXPlay, it sends playout commands to the iTX Player through the Output Server. Instead of managing a live schedule though, it receives commands from one or more iTX Desktop components (e.g. the Live Control) to play out events.

## Extra service-window features for services on the Output Server machine

As well as the features under the common service-window tabs that we describe in an earlier section, there are extra features for:

- TXPlay.
- The Output Server.
- The Media Cache Service.

We explain the TXPlay and Output Server features here. See the next section, "The Media Cache Service", for information on the Media Cache Service.

## TXPlay and TXEdit – service-window headers

The TXPlay and TXEdit windows display the channel names in their headers. They also display a calendar clock (giving the date and time from the Time Service) and the License number of the installed iTX software.

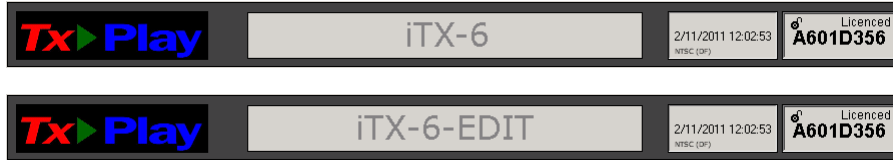

One License covers both the TXPlay and TXEdit channels.

## Output Server 1 – Video Output tab

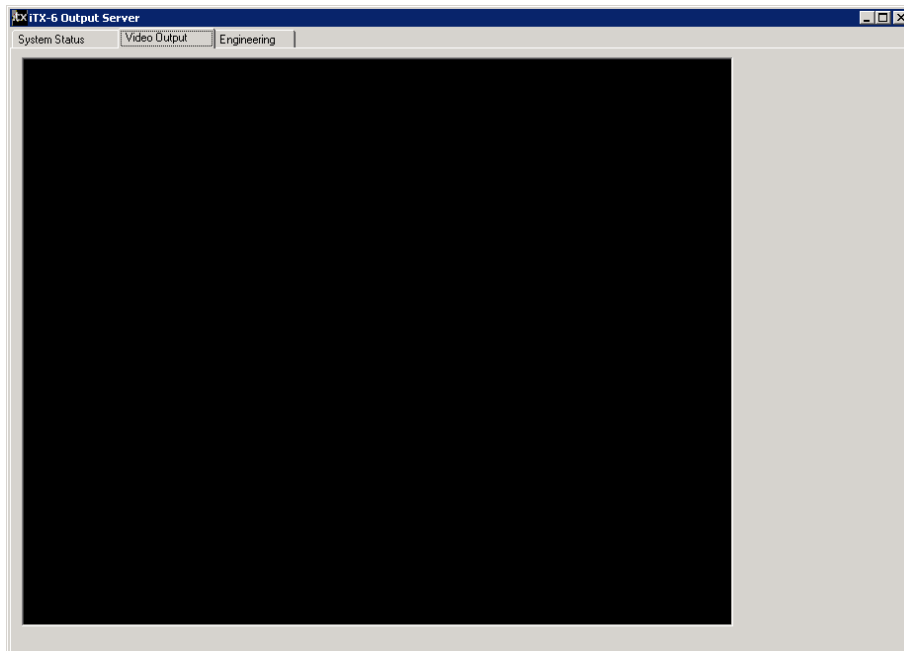

On installing the Output Server software, you can configure a playout channel as a test channel by selecting "Window" from the **Video Card** dropdown menu on the iTX Channel Config dialog. Then, instead of playing out schedules to a transmission system, iTX displays the video in the window under the Video Output tab of its user interface. For normal playout, this window is blank.



## Output Server 1 – Engineering tab

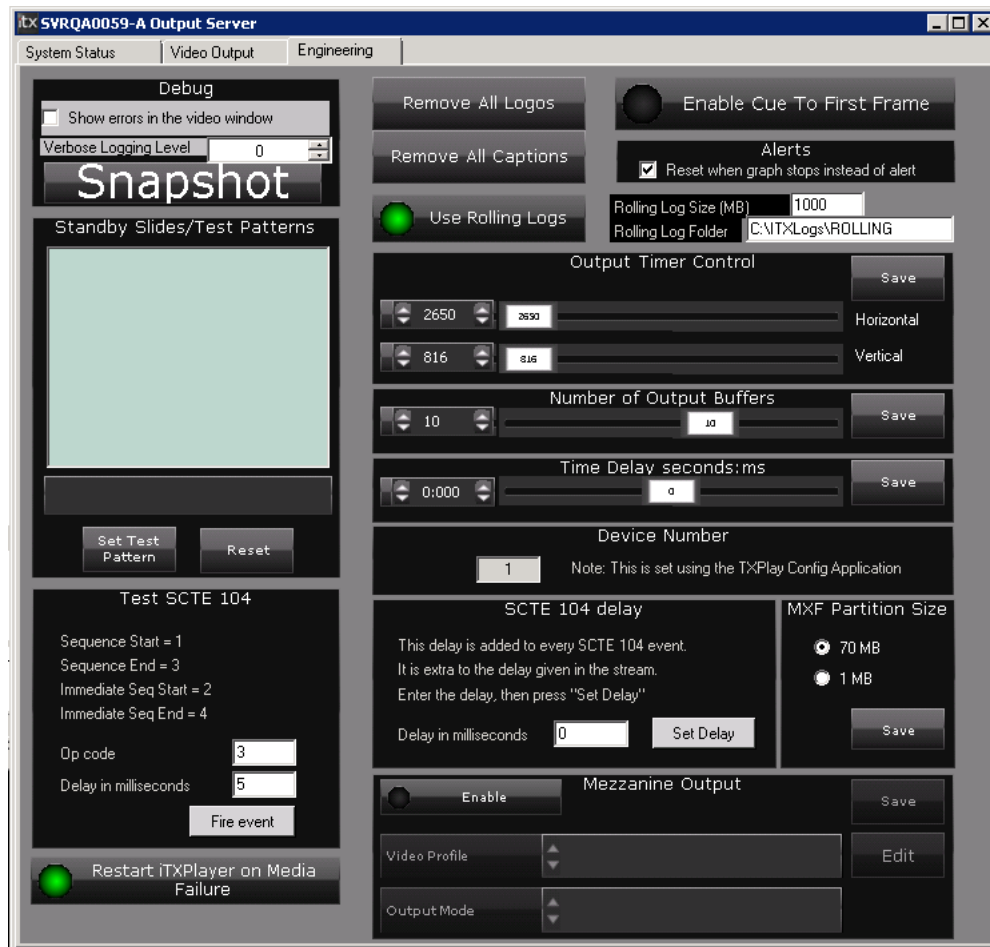

Under the Engineering tab are a number of controls for performing engineering tasks in the channel provided by the Output Server.

### Note:

- This section is only available to channels running the Output Server 1 service. For channels running Output Server 2 see the *Output Server 2 Channel Configuration Guide*.
- The controls in the Debug panel are for the use of software developers, to help with troubleshooting in the event of system problems. The controls are not used when the Output Server is running normally.
- Do not select **Show errors in the video window** unless iTX Support ask you to do so.

### Request the Output Server to create a log file

1. Click **Snapshot** if you want to record the recent activity of the Output Server in a log file.

The default path of the folder in which iTX stores the log files is:

C:\iTXLogs.

You may increase the amount of detail in logs by selecting a higher value (possible values range from 0 to 3) in the **Verbose Logging Level** box.

## Remove all logos

Where an operator has a problem in trying to remove a logo from the screen, you can use a master control to switch off all logos.

1. Click **Remove All Logos** to remove all logos that are currently switched on in a schedule.  
Logos due to come on later in the schedule play as normal.

## Remove all Captions

Where an operator has a problem in trying to remove a CG from the screen, you can use a master control to switch off all CGs.

1. Click **Remove All Captions** to remove all CGs that are currently switched on in a schedule.  
CGs due to come on later in the schedule play as normal.

## Enable Cue To First Frame

Cue to first frame is a feature that enables iTX to act like a traditional video server in displaying the first frame of a video clip that is waiting to be played out.

This takes effect when iTX is not playing out a video clip but holds one cued, ready for playout. It is particularly useful in a system in which iTX supplies a part-time video feed to a downstream transmission device such as a vision mixer.

A video monitor or multiviewer connected to the channel output can then be used to preview the first frame of future clips during breaks in the schedule.

For instance, in a production environment, iTX may provide one of the inputs to a Grass Valley Imagestore 750, while other inputs come from live feeds, studios or other devices.

Cue to first frame requires iTX to cue the video clip to its in-point and display the corresponding frame continuously in the channel output signal. At its scheduled start time, or when taken to air manually, the clip starts playing from the displayed frame.

There are two ways of triggering a cue to first frame:

- It may happen automatically, as a scheduled operation, when the time to the start of a video-clip event equals the channel standby time.
- It may be manually controlled: either by an operator at an iTX Desktop workstation clicking the cue button for the next, or any selected, video-clip event; or by an operator using an Nvision control panel with iTX Master Control.

Where a cue to first frame is triggered while iTX is still playing out a video clip, the first frame will be displayed about 2 seconds after this video clip finishes (if the timing falls within a schedule gap).

iTX can cue multiple clips internally. It does so, for instance, when one video-clip event immediately follows another one that has a duration of less than the channel standby time. iTX outputs the first frame of the first video clip to be cued. It continues to do so, even when other video clips are cued after the first one.

Cue to first frame is also available on channel start-up, when iTX displays colored bars before the first schedule event.

When iTX is not playing out a schedule event or displaying the off-air slide, and there is no video clip cued, it outputs the last frame of the most recent video-clip event – just as it does when the configuration option is not selected.

## Select a standby slide to override the one selected on the Engineering layout

On the Engineering layout, you specify an off-air slide (still image) for the Output Server to display when there is no schedule running. Through the Output Server service window, you can override this setting by selecting a still image from the Test Patterns folder:

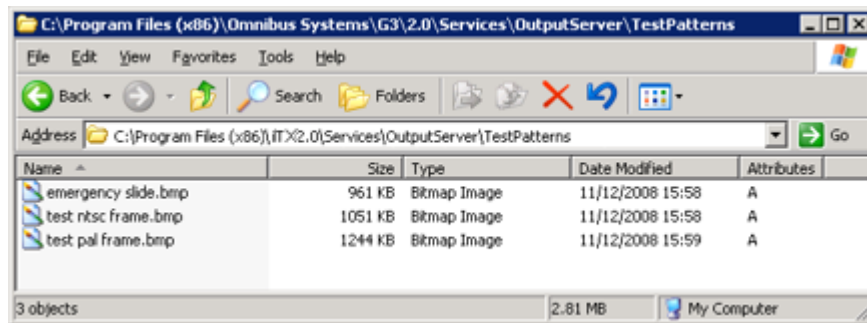

You need to add files to this folder before you can use them. The folder path is: C:\Program Files (x86)\iTX 2.0\Services\OutputServer\TestPatterns

The Standby Slides / Test Patterns window displays thumbnail images of the files in the folder:

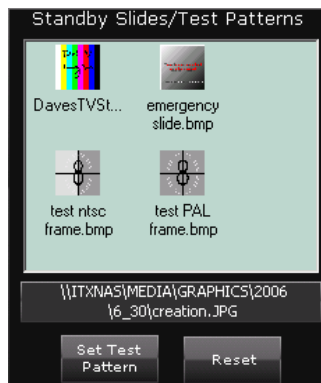

The box under the thumbnails displays the path and filename of the standby slide that you may want to replace.

1. In the Standby Slides / Test Patterns window, select the file that you want to use as a standby slide.
2. Click **Set Test Pattern**.

When there is no schedule running, iTX displays the slide you select.

You can restore the original selection by clicking **Reset**.

## Set up the Output Server for manual or automatic restart if a video clip causes it to freeze

If the Output Server freezes while playing a video clip, it may either restart automatically or display an alert and wait for a manual restart. The behaviour depends on the Alerts setting under the Engineering tab.

Select the check box for the option, **Reset when graph stops instead of Alert**, in the **'Alerts'** box to enable the Output Server to restart automatically. Clear the check box if you want the Output Server to display an alert to restart it manually.

### Switch logging for the iTX Player on or off

Select **Use Rolling Logs** if you want iTX to record the activity of the iTX Player in log files. Ensure the option is not selected if you do not want iTX to do this.

You can limit the size of the log files you wish to be generated (the default is 10240mb) and also set the directory path that you would like the logs to be written to.

The default path of the folder in which iTX stores the log files is:

C:\ITXLogs

We recommend that you have logging switched on for a test period immediately after the installation of your iTX system. The logs may provide relevant information if there are any problems with the types of media file you use. You may switch it off once you are satisfied there are no such problems.

### Send a test SCTE 104 command from the Output Server to TXPlay

A SCTE 104 message in a live video signal prompts a "take next" response from iTX when the next event in a playout schedule is a sequence. The sequence must be set to allow external takes. You can simulate the sending of an SCTE 104 message by using the button in the Test SCTE 104 panel.

1. In the **Op code** box, enter one of the following.
  - Enter a "1" for iTX to send an SCTE 104 command to start the playout of the sequence.
  - Enter a "3" for iTX to send an SCTE 104 command to end the playout of the sequence.
2. In the **Delay in milliseconds** box, enter a value (in thousandths of a second) for any delay you want TXPlay to allow before it responds to an SCTE 104 command.
3. Click **Fire event** to request the Output Server to send an SCTE 104 command to TXPlay.

### Set the delay for an SCTE 104 command from the Output Server to TXPlay

You can set the delay TXPlay allows before it responds to an SCTE message. The delay applies to certain types of SCTE 104 message sent from the Output Server to TXPlay.

1. In the **Delay in milliseconds** box, enter a value (in thousandths of a second) for the delay.
2. Click **Set Delay**.

### Adjust the output timing for the Output Server SDI video card

For an Output Server machine with a Xena 2Ke SDI video card, you can adjust the horizontal and vertical output timing relative to the time reference signal. This allows the SDI video card to synchronise an incorrectly timed video input signal to the time reference signal.

When this synchronisation occurs, the SDI video card drops or repeats frames from the video input signal.

1. Do one of the following to set the horizontal output timing.
  - In the **Horizontal** box, enter the output timing value.
  - Move the **Horizontal** slider to select the output timing value.
2. Do one of the following to set the vertical output timing.
  - In the **Vertical** box, enter the output timing value.
  - Move the **Vertical** slider to select the output timing value.
3. Click **Save**.

### **Specify a number of frames for the output buffer on the Output Server SDI video card**

To ensure it delivers a smooth output, iTX temporarily stores processed frames in an output buffer on the SDI video card before playing them out. This gives it time to process successive frames of video before they are needed for playout.

The default size of the buffer is normally 10 frames; this satisfies most playout requirements.

Sometimes, such as when iTX has to do a lot of complex video processing, it may be necessary to set a different value. You can do this on the Number of Output Buffers panel.

1. Do one of the following to set the size of the output buffer.
  - In the **Output Buffer** box, enter the required number of frames.
  - Drag the **Output Buffer** slider to select the required number of frames.
2. Click **Save**.

#### **Important:**

- Before changing the buffer size, you should contact iTX Support and discuss the effects of the change on system performance.

### **Adjust the timing of the internal video processing**

Use of the output buffer on the SDI video card introduces a small delay in the timing of the output. For instance, any particular video frame may play out a few frames after its actual scheduled time. Although it is possible to adjust the internal video processing to remove this delay, in most playout situations it is not necessary to do so.

The output timing is of more importance for transitions, such as when switching the output of a master channel into and out of regional sub-channels. For accurate transitions, the internal processing may need adjusting to take account of the throughput time of a live source.

You can cause iTX to process video earlier or later by up to 30 frames by using the controls on the Frames Delay For Time Sync panel.

1. Do one of the following to adjust the timing of the internal processing.
  - In the number box, enter the required number of frames (between -30 and 30).
  - Drag the slider to select the required number of frames.

2. Click **Save**.

## Device Number

This window indicates the device number of the Output Server AJA Card if the Output Server machine is an iTX Appliance Server capable of supporting multiple playout channels in one server. The device number is configured during installation and cannot be changed from here.

## MXF Partition Size

These radio buttons allow you specify whether the output server should read the minimum (duration, frame count and vital information only) or maximum available data from the closing footer of MXF files.

## Restart iTX Player on Media Failure

By default 'Restart iTX Player on Media Failure' is disabled. If Pandora encounters a media error the standby slide will be displayed, allowing the operator time to 'Take Next'.

When this option is enabled if Pandora encounters a media error it will restart iTX Player.

## Mezzanine Output

This panel is where you enable and configure the IP based simulcast option. A special type of Encode Profile is used to determine the secondary output format which is loaded from here.

You also set the Output mode from here, of which there are four options:

- **Complete** – Outputs the video/audio exactly as it plays to air including all iTX keyed graphics and inserted data.
- **Before Branding** – Outputs the video with iTX inserted data (subtitles, AFD information etc.) but without any keyed graphics
- **Before All** – Outputs the video without any iTX keyed graphics or inserted data.
- **Channel Output** – This can be used to record the downstream output of the channel, but requires some special considerations as detailed below:

For more information on the IP Simulcast option, see the *IP Simulcast Output User Manual*.

## The iTX Player window

The iTX Player displays its own window, which is different from the standard user interface:

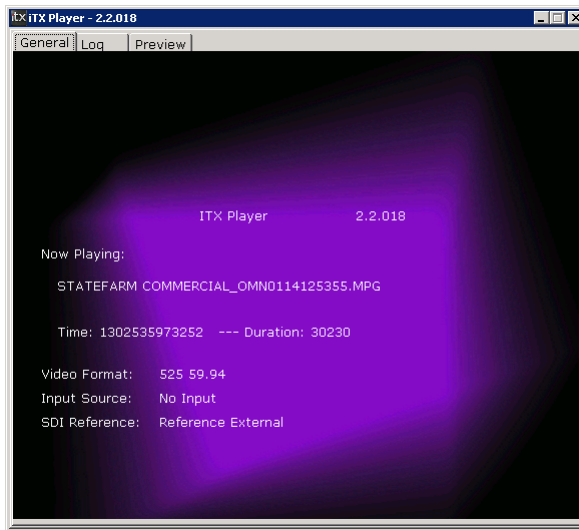

Under the General tab, this window displays details of the media file that the iTX Player is currently playing.

It also displays details of: the video format of any live signal (Input Source) being fed into Input 1 of the SDI video card; the SDI reference input (SDI Reference).

If the format of the Input Source signal changes (e.g. from HD 1080i to HD 720p), TXPlay re-configures the channel output to the new format. This causes first the Output Server and then the iTX Player to restart.

You may use this effect to automatically change the output format of a channel at planned times of the day. You should be careful, though, not to inadvertently change the channel configuration by changing the format of the Input Source signal.

The information under the Log tab is not used when the Output Server is running normally.

# The Media Cache Service

The job of the Media Cache Service is to manage the cache – a shared folder called Cache – on an Output Server machine the cache holds media files ready for playout.

The service interacts with other iTX services to copy media files to the cache, to meet the requirements of a schedule loaded in the playout channel; it can make space in the cache by deleting unwanted media files.

If a required file is missing from the cache, iTX may play it out from a Media Store instead.

In this section, we describe the caching process for an Output Server machine.

## Caching in a single domain

The Media Cache service interacts with TXPlay and other services in the way we describe below. This diagram shows the process:

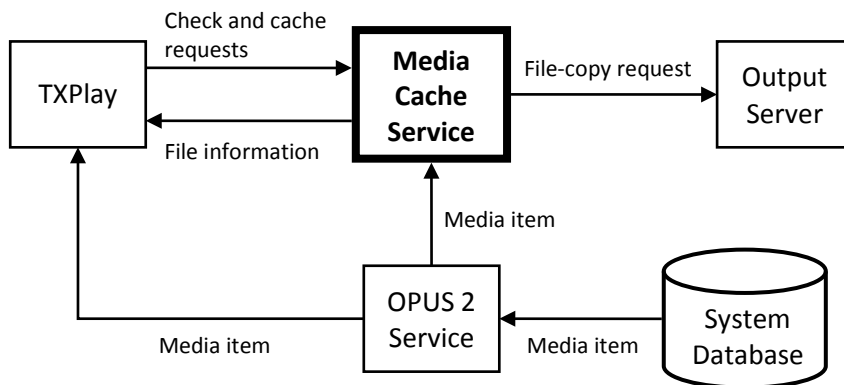

### Checking media items

When a schedule is loaded in a playout channel, TXPlay notifies the Media Cache Service of media files that the schedule requires. If there are copies of any of these files in the Output Server cache, the Media Cache Service protects them from being deleted.

In the Schedule Grid, all events show a status of 'Not Ready' (colour-coded yellow); a dash (–) in the Cache column indicates a media item that the Media Cache Service is yet to process.

TXPlay selects each event in turn, starting with the first event in the schedule, and requests the Media Cache Service to check the associated asset in the System Database.

The Media Cache Service uses the OPUS 2 service to get an asset from the System Database. It then gives TXPlay details of the location of the media file. As TXPlay receives these details for each event, it updates the event status in the Schedule Grid to 'Ready' (colour-coded white).



## Cache requests

Starting with the first Ready event, TXPlay requests the Media Cache Service to ensure the required media file is in the cache. Once the file is cached, it does the same for each Ready event in turn.

The Media Cache Service responds to TXPlay cache requests in one of two ways, depending on whether or not there is already a copy of the required file in the cache:

- If there is a copy of a required file in the Output Server cache, the Media Cache Service compares this with the original version in the specified location. If the two files are the same, no caching operation is needed. The Media Cache Service reports this to TXPlay. In the Schedule Grid, the specified file location is the cache; the cache-status indicator appears with a green light [●].
- If there is no copy of the required file in the Output Server cache, or if there is a copy but it does not match the original version, caching is required. The process differs slightly, depending on whether the location of the original file is an iTX Media Store or a search folder (e.g. for an archive). There is also a slightly different process for a file that is being ingested by an iTX Encoder.

## Caching from an iTX Media Store

When the Media Cache Service starts caching a media file from an iTX Media Store, the cache-status indicator for the event shows orange [●].

The Media Cache Service ensures there is enough space in the cache (see below, "Cache management"). It then uses the Output Server to copy the media file to the cache; the Output Server controls the copy rate.

When the media file is in the cache, the Media Cache Service notifies TXPlay. This updates the event in the Schedule Grid to show the cache as the file location; the cache-status indicator turns green [●].

## Caching from a search folder

When the Media Cache Service starts caching a media file from a search folder, the cache-status indicator for the event shows orange [●] if iTX can play out the file from the search folder; it shows blue [●], instead, if the search folder is an archive.

To copy media files from a search folder, the Media Cache Service uses the Media Watcher; this must be set up to access the search folder. Depending on how it is configured for this, the Media Watcher copies the media file to one of two places:

- An iTX Media Store, if the **Copy media to central store** option is selected in the configuration of the search folder.  
The Media Cache Service then manages the copying from the Media Store to the cache.
- Direct to the Output Server cache, if the **Copy media to central store** option is not selected. The Media Cache Service notes when the file is in the cache.

When the media file is in the cache, the Media Cache Service notifies TXPlay. This updates the event in the Schedule Grid to show the cache as the file location; the cache-status indicator turns green [●].

## Caching a file that is being ingested

When the Media Cache Service prepares to cache a media file that is being recorded by an iTX Encode Server, the cache-status indicator for the event shows blue [●]. Once the file is on the Media Store, the Media Cache Service caches it; the cache-status indicator first turns orange [●], and then green [●].

## Skipping of missing media files

In progressing through a schedule, TXPlay skips any event for which the required media file is not in the system. If the media file later becomes available, TXPlay sends a cache request for it to the Media Cache Service.

## Interruption to caching

The Media Cache Service receives cache requests from TXPlay for one event at a time in schedule order. Once it starts a job, unless it is interrupted to do a higher-priority job, it continues until caching is complete. It does this even if the event that requires the media file being cached is deleted from the schedule.

If the live schedule is modified in a way that causes a media file for an earlier event to require caching, the Media Cache Service stops the current job and starts the caching operation for the earlier event. On finishing this, the service continues to process jobs in schedule order.

If a new schedule is loaded in the playout channel and it contains no event that requires the media file currently being cached, the Media Cache Service stops caching the file. It then starts caching for the new schedule.

## Cache management

When there is not enough free space in the cache for the next media file that needs to be added, the Media Cache Service has to make space; it does this by deleting media files that are no longer required.

In determining which files to delete, it first identifies those files for which there are no schedule requirements. From these, it selects the one that was least recently scheduled and deletes it; it selects and deletes other files in the same way until there is enough free space for the required file.

In the Schedule Grid, when there is insufficient cache space, the cache status indicator for the event that the Media Cache Service is attempting to cache the media file for shows red [●].

### Note:

- The Media Cache Service does not delete cached media files that are required by events later than the one it is processing. This may cause it to be unable to make enough space for a particular media file; iTX then has to play out a media file from the Media Store. To prevent such a situation, the cache should be set up with a capacity large enough to meet the requirements of the most demanding schedule.

## Caching in a multi-domain system

In a multi-domain system, the Media Cache Service uses the OPUS 2 Service to search the local domain for a required media item. If the OPUS 2 service cannot find the media item there, it searches other domains – in the configured order (see below, "Search order of domains in multi-domain caching") – until it finds the media item. The Media Cache Service then passes the media-file location details to TXPlay.

If the location is one that iTX can play out the media file from, the event status in the Schedule Grid changes to Ready; the event shows the search folder in the remote domain as the media-file location; the cache-status indicator shows orange [●]. If the location is an archive, the event status in the Schedule Grid stays Not Ready; the event shows the search folder in the remote domain as the media-file location; the cache-status indicator shows blue [●].

As in a single-domain system, the Media Cache Service uses the local Media Watcher to copy the file from the search folder in the remote domain to the local domain. Depending on the search-folder configuration, the Media Watcher copies the file to either an iTX Media Store or the cache. See earlier in this section, "Caching from a search folder".

## Caching for a sub-channel

When you set up a sub-channel (e.g. for playing out schedules in a regional channel), you install a Media Cache Service on the Output Server machine for the sub-channel. This service then manages the cache for the sub-channel.

Only the locally required content, i.e. media files for events that are played out only in the sub-channel, is stored in the sub-channel cache.

The cache on the main Output Server machine, managed by the Media Cache Service on that machine, holds the content for the main channel.

## Search order of domains in multi-domain caching

In multi-domain caching, both TXPlay and the Media Cache Service use the OPUS 2 Service to search remote domains. This service searches the domains in a particular order until it finds required media items.

You specify this order – for both TXPlay and the Media Cache Service – in a multi-domain configuration panel.

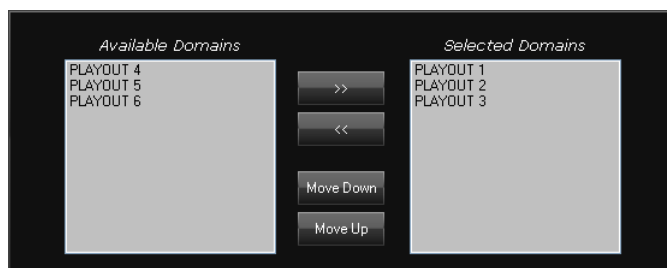

For Output Server 1, the panel appears in the Engineering layout, under Channel Config > Cache Settings (with a cache channel selected)

For Output Server 2, the panel appears on the Configuration tab of the Media Cache 2 user interface. For more information see the *iTX Output Server 2 Channel Configuration Guide*.

The panel for TXPlay appears under the TX Channel Automation Config tab for the playout channel; that for the Media Cache Service, under the Cache Settings tab for the cache channel.

The domains in the Selected Domains pane must be the same, and in the same order, for both services.

## Setting up a system for multi-domain caching

There are a number of ways in which you can set up a system to handle the copying of media files between two iTX domains. The required procedure depends on whether or not you want iTX to register files by creating media items for them in the System Database of the new domain.

In registering a file, iTX creates either a whole new media item or one that includes information (e.g. in- and out-points) from the corresponding media item in the original domain. The copying of information from another media item requires the External Multi-domain plug-in.

### Set up a system to copy files without registering them in the new domain

Use this procedure for the copying of files that you want iTX to hold only temporarily in the new domain. The Media Cache Service removes such files in its cache management operations when they are no longer needed for playout.

1. Do the following to configure the Media Watcher in the new domain.
  - Add the file store in the remote domain as a Search folder.
  - Ensure **Copy media to central store** is not selected for this folder.
  - Select **Search for Omnibus '\_OMN' files**.
2. Ensure the user account you use to run the Output Server machine has access rights to the Search folder.
3. Set the remote-domain search order for both TXPlay and the Media Cache Service on the Channel Configuration pop-up layout.

### Set up a system to copy files and register them in the new domain

## Media Cache Service window

The Media Cache Service displays information in a standard iTX service window.

### Media Cache 1/2 - Service Details

Under the Service Details tab, information about the cache channel and the caching service is organised under separate sets of sub-tabs:

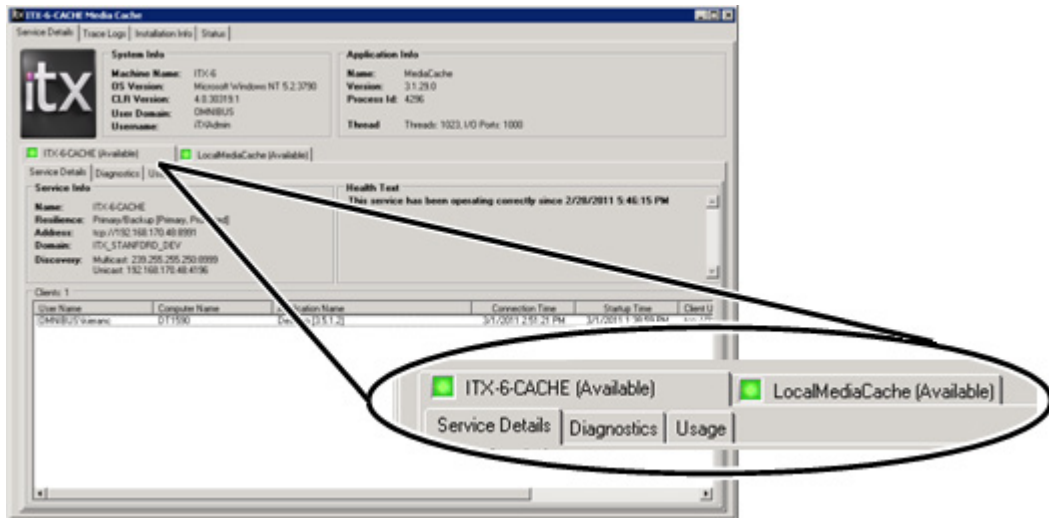

The cache-channel sub-tab shows the name of the cache channel and its operating status (a green light indicates normal operation). Under this tab, you can view details of client connections to the cache channel. These are usually iTX Desktop clients with channel views that include the cache channel. A Schedule Grid (e.g. the one on the Channel Control layout) connected to a cache channel displays details of the cache contents.

Under the caching-service sub-tab, you can view connection details of services that interact with the Media Cache Service.

### Media Cache 1/2 - Status tab

As well as the standard tabs (Service Details, Trace Logs, etc.), the service window has a Status tab:

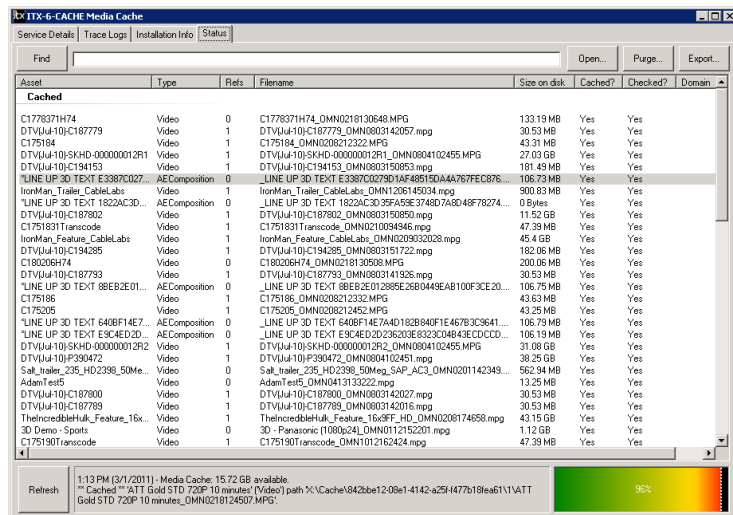

Under this tab, the Media Cache Service displays a list of all the media files in the cache; also any media file that is currently being cached. The information is arranged in these columns:

Column	Description
Asset	The unique iTX name of the media item that references the media file.

Column	Description
Type	The type of media item (video, logo, etc.) that references the media file.
Refs	The number of playout and edit channels that reference the media file.
Filename	The name of the media file.
Size on disk	The size of the media file.
Cached?	Whether or not the complete media file is cached. This is "Yes" for complete files in the cache; "No" for any file that is only partially cached, or for which not all essence files (e.g. in an MXF file) are present.
Checked?	Whether or not the Media Cache Service has checked the file.
Domain	The domain in which the media item is stored. The entry is blank when this is the local domain.

The **Refresh** button flashes when any change is made to the cache content while the Status tab is selected; clicking the button updates the information under the tab.

The space gauge in the bottom, right of the window shows how much of the cache (as a percentage) is taken up with media files.

You can use the buttons at the top of the window for manual actions:

- **Open**, to open the cache sub-folder that contains a selected media file.
- **Purge**, to instruct the Media Cache Service to remove all items from the cache that are not required for events in the current schedule.
- **Export**, to create a .csv file of the cache list.

## Media Cache 2 - Configuration tab

If you are operating a playout server using v2.6 Output Server 2 or higher, the Media Cache service window includes a Configuration tab. This tab includes options for controlling caching thresholds, and selecting which Media Watcher and domain to use.

For more information see the *iTX Output Server 2 Channel Configuration Guide*.

## Cache channel in a Schedule Grid

On an iTX Desktop layout, you can connect a Schedule Grid to a cache channel and view detailed information (including % cached) on cache contents:

Asset	Type	Path	Status	Percent	MB/s	Size on disk	Ref	Modified	Domain
C178373474	Video	X:\Cache\17438769-3070-4444-9490-4fd3	Checked	100%	-	133.19 MB	0	18-39-52	-
LINE UP 3D TEXT D78C45B4018	AECo	X:\Cache\13abd3bb-eb0d-426d-84ea-73	Checked	100%	-	106.75 MB	0	18-39-52	-
C178373474	Video	X:\Cache\1172ba8e-1874-46cd-9394-139	Checked	100%	-	132.75 MB	0	18-39-52	-
3D Demo - Documentaries	Video	X:\Cache\ea040ca2-d8d1-413d-866c-3a	Checked	100%	-	1.12 GB	0	18-39-52	-
IndianaJonesIV Trailer CableLab	Video	X:\Cache\ec4f008c-cb67-4332-8c21-ca	Checked	100%	-	675.7 MB	1	18-39-52	-
DTV\ul10\C187780	Video	X:\Cache\98de16c9-9439-426d-6099-209	Checked	100%	-	30.53 MB	1	18-39-52	-
3D - Panasonic (1080p24)	Video	X:\Cache\ea79e26e-9594-427e-65e1-99	Checked	100%	-	1.12 GB	0	18-39-52	-
C175191	Video	X:\Cache\7ad75c29-1064-4814-b155-e5	Checked	100%	-	42.81 MB	1	18-39-52	-
dave test of daughter	Video	X:\Cache\6ba8271-5104-462d-4979-c3d	Checked	100%	-	162.31 MB	0	18-39-52	-
1080p2398 SlumdogMillionaire	Video	X:\Cache\60c2803-3ef-4c89-bd34-24	Checked	100%	-	43.48 GB	1	18-39-52	-
DirecTV Cinema 1080p	Video	X:\Cache\443021c1-1ab6-46bc-bca0-90	Checked	100%	-	190.38 MB	0	18-39-52	-
C175193	Video	X:\Cache\42927fbc-8959-4a95-9498-ad	Checked	100%	-	26.08 MB	1	18-39-52	-
C180206H74	Video	X:\Cache\410c22ee-3604-42bd-53bd-20	Checked	100%	-	193.94 MB	0	18-39-52	-
DTV\ul10\C187782	Video	X:\Cache\ca816f91-6994-4892-9469-c9c2	Checked	100%	-	30.53 MB	1	18-39-52	-
3D - Everest (1080p24)	Video	X:\Cache\93049c21-1ed1-4010-699a-11c	Checked	100%	-	3.27 GB	0	18-39-51	-
C175197	Video	X:\Cache\c4904764-6384-4e1c-b304-a3	Checked	100%	-	43.25 MB	0	18-39-51	-
IndianaJonesIV Feature CableLab	Video	X:\Cache\c1390aaa-d817-4ea9-8a8e-51	Checked	100%	-	44.14 GB	1	18-39-51	-
DTV\ul10\C187729	Video	X:\Cache\4d41181c-c959-4e42-bae3-be1	Checked	100%	-	30.53 MB	1	18-39-51	-
3D Demo - Avatar Trailer	Video	X:\Cache\bbb6ab29-ab6b-419b-92bc-57	Checked	100%	-	1.12 GB	0	18-39-51	-
C178369474	Video	X:\Cache\1d1d021-09e4-489e-8772-906	Checked	100%	-	133.19 MB	0	18-39-51	-
LINE UP 3D TEXT 740898322840	AECo	X:\Cache\10ba0763-1172-41e3-8906-933	Checked	100%	-	106.73 MB	0	18-39-51	-
C175183	Video	X:\Cache\10ade37b-c98c-4413-905e-09	Checked	100%	-	42.81 MB	0	18-39-51	-
C1752051Transcode	Video	X:\Cache\1abc118e-e9d1-4463-a43c-9e4	Checked	100%	-	47.84 MB	0	18-39-51	-
DTV\ul10\C187794	Video	X:\Cache\af5483bd-5ca7-450c-8ee7-e2	Checked	100%	-	199.63 MB	0	18-39-51	-
3D Demo - Concerts	Video	X:\Cache\948fae60-5957-4ae4-e4b2-a9	Checked	100%	-	1.12 GB	0	18-39-51	-
C175204	Video	X:\Cache\99b61cb-00de-4984-atof-331	Checked	100%	-	43.25 MB	1	18-39-51	-
DISNEY BOLT CONTENT HD-239	Video	X:\Cache\9963862c-0442-428d-b668-769	Checked	100%	-	34.71 GB	1	18-39-51	-
DTV\ul10\C187791	Video	X:\Cache\95044799-d87b-40ee-ad19-7d	Checked	100%	-	30.53 MB	1	18-39-51	-
DTV\ul10\C187794	Video	X:\Cache\97c368848710-43be-beaf-45	Checked	100%	-	30.53 MB	1	18-39-51	-
DTV\ul10\C187793	Video	X:\Cache\8140446-194d-4833-a389-42d	Checked	100%	-	30.53 MB	1	18-39-51	-
Advert.m4f	Video	X:\Cache\98c33acc-07d2-444e-9b49-b9	Checked	100%	-	13.25 MB	0	18-39-51	-
3D Demo - Toy Story 3 Trailer	Video	X:\Cache\8a362a6-b2d1-47d9-8b3c-473	Checked	100%	-	1.12 GB	0	18-39-51	-
Advert.m4f	Video	X:\Cache\8923a978-2a6b-418c-bc1b-3e	Checked	100%	-	13.25 MB	0	18-39-51	-

When you move your mouse pointer over the entry for any media file, a tooltip appears (provided tooltips are switched on) showing the recent history of checking and caching operations for the file.

# Working with iTX services on an Encode Server machine

The Encode Server machine runs the following interacting iTX services under the control of a Server Controller.

- The **Encode Server** responds to requests to record an SDI video feed; it controls the iTX Encoder, which performs the recordings.

A request may come from an operator using features on an iTX Desktop layout; or from another iTX service, the Ingest Control Service, which manages scheduled recordings.

- The **iTX Encoder** converts an SDI video feed into a file in a specified standard storage format (MPEG-2 or MOV).
- The **iTX Software Updater**. [More details](#), page 287.

Depending on the SDI video card installed in the Encode Server machine, the Encode Server can record SD or HD video content with embedded audio content. (An Encode Server that can record HD video content can also record SD content.)

## Creating media files

In a recording session, the iTX Encoder creates a media file on the configured Media Store and streams encoded data across the network until the recording is complete.

The copying process allows an operator to have access to the file while the recording is going on; the operator can view the file on the Media Store and use it in a playout schedule.

If network problems prevent the successful copying of the file to the Media Store, the local file is not deleted. This can be ingested into iTX in the normal way, through the Media Store Inbox.

## Registering media files

For each recording, the Encode Server places an XML registration file, containing recording details, in the Inbox monitored by the Media Watcher. The Media Watcher copies the information from this file to the System Database and then deletes the file.

## Recording of VANC data

The iTX Encoder can automatically detect VANC information in the digital video source and record it: up to 8 lines for 1080i; up to 20 lines for 720p.

## Video-format detection

When a recording is prepared, the iTX Encoder can automatically detect the video format of the digital video source. This reduces the chance of errors from changing sources without changing the setting for the video format.



## Encode Server control of a VTR

An Encode Server may control a VTR (videotape machine) during ingest operations. More details are in the iTX Hardware Specification, which you can download from the Club iTX website.

## Extra service-window features for the services on an Encode Server machine

As well as the common service-window tabs that we describe in an earlier section, the Encode Server has an extra tab:

- Settings.

### Encode Server – service-window header

The Encode Server window displays the recording-channel name in its header. It also displays the License number of the installed iTX software.



The header contains two status indicators:

- The session indicator flashes yellow when the service is claimed for a recording.
- The recording indicator flashes red when a recording is in progress. You should not change the service configuration during a recording.

### Encode Server – Settings tab

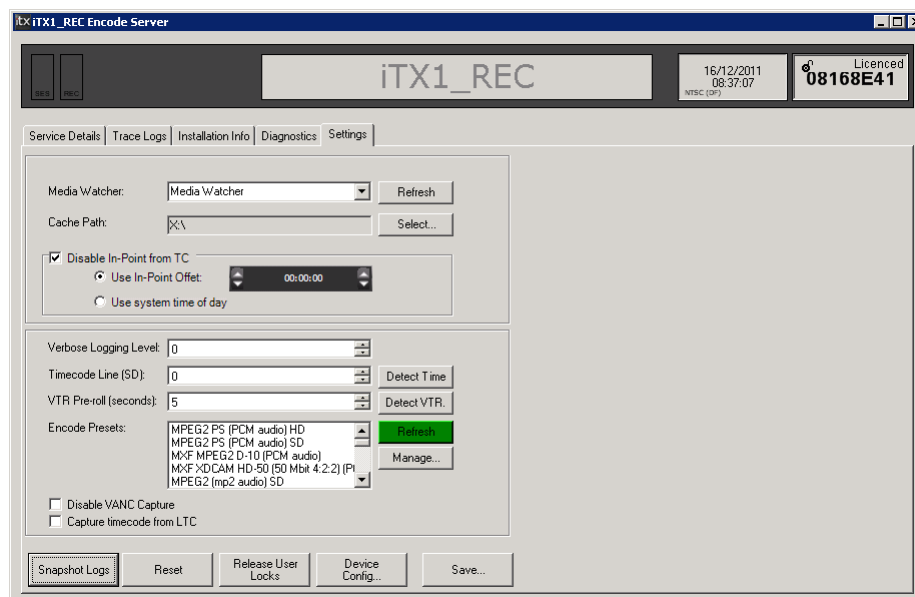

Under the Settings tab are a number of features for performing system-administration tasks in the channel provided by the Encode Server. After changing any settings, save them by clicking **Save**.

## Select a Media Watcher for file registration

The Media Watcher registers encoded media files in the System Database. In a system with multiple Media Watchers, you need to select one of them to perform this task.

1. Click **Refresh** to update the list of Media Watchers.
2. Select a Media Watcher in the **Media Watcher** box.

## Import encode presets

The **Encode Presets** box displays a list of encode presets that are to be available for recordings; these determine the video properties (storage format, bit rate, etc.) of the files created by an Encode Server.

The first time the Encode Server is installed, there are no encode presets on the machine; the **Encode Presets** is blank. You need to import encode profiles from the installation folder. For this you use the Manage Global Presets dialog:

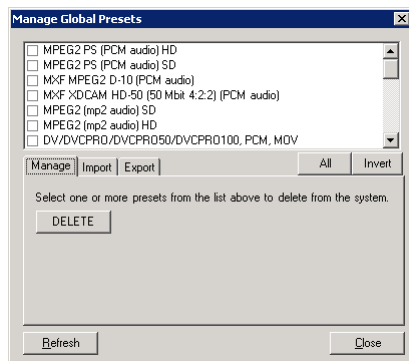

1. Click **Manage** to display the Manage Global Presets dialog.
2. Do the following to select presets to import.
  - Select the **Import** tab.
  - Click **Import** to display the Select One Or More Presets dialog.
  - Open the Presets folder in the iTX installation folder.
  - Select the presets you want to import; close the dialog.
  - Click **Close** to close the Manage Global Presets dialog.

The **Encode Presets** box displays a list of the imported encode presets. (Click **Refresh** if it does not.)

**Note:** You can use the Manage Global Presets to delete or export encode presets.

## Set the in-point timecode flag for recordings

For the in-point of the recorded media, the iTX Encoder may take the timecode from the digital video source or it may set a value of zero (00:00:00:00). You select the option you want it to use.

1. Do one of the following.
  - If you want the in-point timecode of all recordings to be zero, select **Disable In-Point from TC**.
  - If you want the in-point timecode to be taken from the digital video source, ensure **Disable In-Point from TC** is not selected.
2. If you want the first frame of the recorded file to have a non-zero timecode, enter the required value in the **Offset In-point** box.

## Request the iTX Encoder to detect the timecode track in an SD video feed

For the recording of timecode, you can use the iTX Encoder to detect the timecode track in the digital video source. (This is not necessary for an HD video feed.)

1. In the **Timecode Line (SD)** box, enter the number of the line that the video feed carries timecode on.
2. Click **Detect Time**.

The Encode Server checks the incoming feed for the timecode track, starting on the line number you specify in the **Timecode Line (SD)** box.

- If it detects the timecode track on this line, the Encode Server displays a confirmation message.
- If it detects the timecode track on a different line, the Encode Server enters the correct line number in the **Timecode Line (SD)** box.

## Set the pre-roll time for a VTR connected directly to the Encode Server

For a VTR, pre-roll is the time difference (in seconds) between the point where the Encode Server starts playing a videotape and the point where it starts recording.

1. In the **VTR Pre-roll Time** box, enter a value for the pre-roll time.

## Test the connection between an Encode Server machine and a VTR

Where an Encode Server is set up to directly control a VTR, you can test the connection between the two machines.

1. Ensure the VTR is switched on.
2. Click **Detect VTR**.

iTX displays a dialog requesting you to confirm that you want the test to continue.

3. Click **OK** to continue the test.

iTX checks the connection between the VTR and the Encode Server machine. It then displays a dialog stating whether the connection is working or not.

4. Click **OK** to close the dialog.  
You can view a report of the machine-control status under the Diagnostics tab.
5. After proving the connection is working, prepare the machine for a recording.
  - Ensure the VTR is in the remote mode.
  - Insert a videotape in the machine.

### Release a locked Encode Server

1. Click **Release User Locks** if you want to release an Encode Server that an operator has locked for recording.

### Restart the Encode Server

1. If the Encode Server becomes unresponsive, click **Reset** to restart it.

### Request the Encode Server to create a snapshot log file

A snapshot log file records the recent activity of the Encode Server.

1. Click **Snapshot Logs** if you want the Encode Server to create a snapshot log file.

The default path of the folder in which iTX stores the log files is:

C:\iTXLogs

# Using iTX Desktop layouts for system administration

There are a number of iTX Desktop layouts that provide you with most of the information and controls that you need when performing routine system-administration tasks. In this section we describe the main features on such layouts by referring to two main layouts:

- The Engineering layout.
- The Server Manager layout.

The Engineering layout gives you access to a number of pop-up layouts. Some of these (e.g. the Channel Configuration pop-up layout) are described in other sections of this manual. In this section, we describe these pop-up layouts:

- The Active Alerts pop-up layout.
- The Logging pop-up layout.
- The OPUS Administration pop-up layout.
- The Naming Rule Configuration pop-up layout.
- The Colour Configuration pop-up layout.

In your system, some of the described features may appear on a different set of layouts.

## The Engineering layout

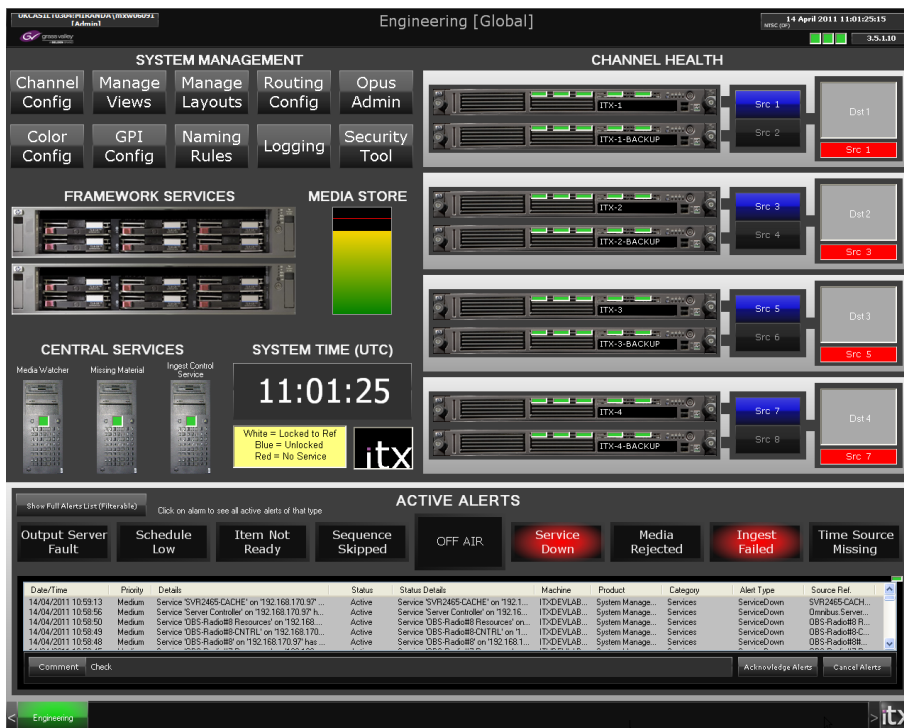

The screenshot displays the 'Engineering [Global]' interface. The top right shows the date '14 April 2011 11:01:25:15' and version '3.5.1.10'. The main area is divided into several functional blocks:

- SYSTEM MANAGEMENT:** Includes buttons for Channel Config, Manage Views, Manage Layouts, Routing Config, Opus Admin, Color Config, GPI Config, Naming Rules, Logging, and Security Tool.
- CHANNEL HEALTH:** Shows a vertical stack of channel monitors for ITX-1 through ITX-4, each with 'Src' and 'Dest' buttons.
- FRAMEWORK SERVICES:** Displays a rack of server units.
- MEDIA STORE:** Shows a vertical bar representing media storage levels.
- CENTRAL SERVICES:** Includes 'Media Watcher', 'Missing Material', and 'Ingest Control' indicators.
- SYSTEM TIME (UTC):** Displays the current time as '11:01:25' with a legend: 'White = Locked to Ref', 'Blue = Unlocked', 'Red = No Service'.
- ACTIVE ALERTS:** A table at the bottom lists active alerts with columns for Date/Time, Priority, Details, Status, Status Details, Machine, Product, Category, Alert Type, and Source Ref. Buttons for 'Acknowledge Alerts' and 'Cancel Alerts' are present.

## Monitoring iTX services

Once you have configured the Engineering layout for your system, you can quickly see the operational status of all the key iTX services that are running. You get this information from the service status indicators on this layout.

The Server Monitor has indicators for services on the Database Server machine:



Channel Monitors have indicators for services on Output Server machines:



A Service Provider Monitor has an indicator for any selected service (e.g. a Media Watcher):

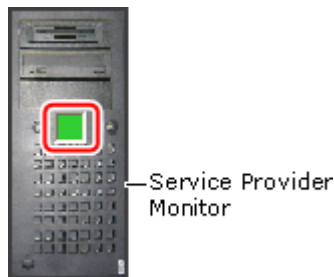

[More details](#) about service-status indicators, page 98.

## Selecting a different playback source in a transmission chain

A group of layout features show the transmission chain for a channel, with main and back-up Output Servers:

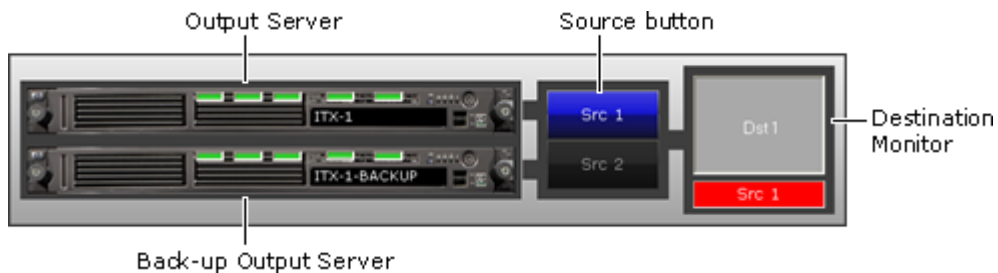

For each Output Server, there is a router source button. The Destination Monitor represents the transmission system that iTX delivers its output signal to.

When iTX is set up to operate a matrix router, the buttons are mapped to the router sources that the Output Servers are connected to. You can route either Output Server to the transmission system by clicking the associated source button. The UMD in the bottom of the Destination Monitor shows the name of the connected source.

If iTX is not set up to operate a matrix router, the source buttons are configured for the hardwired router – a software device that you use to update iTX when primary and back-up Output Servers swap roles outside of iTX control. To prompt an update, the buttons should be operated when you manually failover an Output Server, so that they always show which is the live channel in the transmission chain.

## View the Media Store Gauge

The Media Store Gauge gives you a visual indication of the amount of free space on the Media Store.

Various details appear when you rest your mouse pointer over the Gauge.

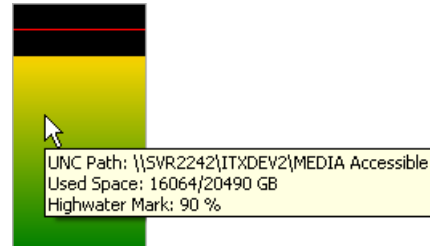

## Monitoring system alerts

The Active Alerts panel displays a number of alert buttons above a general active-alerts list:



You can see details of alerts that the Alerts Service generates and react to them.

## Alert buttons

Alert buttons are associated with particular system conditions that may require your attention, such as a channel going off air. The label on a button describes the condition. If this condition arises, the alert button flashes red.

Clicking the button displays a pop-up layout with a list of all current alerts of the same type:

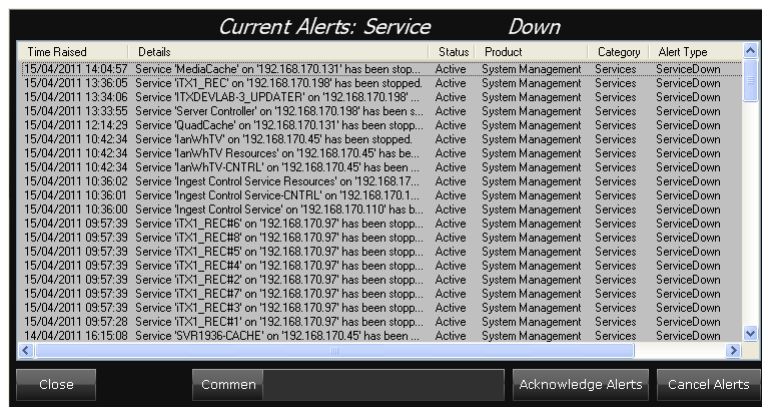

You can acknowledge and cancel these alerts, as you can any of the alerts in the general active-alerts list (see below).

## Active Alerts list

The Active Alerts list shows all the alerts that the Alerts Service generates and that are still active. Alerts highlighted in red require immediate attention.

Any active alert is cancelled, and removed from the Active Alerts list, in one of two ways:

- Either, the iTX system cancels the alert. It does so if it detects that the condition that caused the alert no longer exists.
- Or, you manually cancel the alert.

If you manually cancel an alert while the alert condition remains, the Alerts Service generates the alert again.

Where iTX generates an alert that is signalled by an audible alarm or a flashing light, you can stop the warning signal by acknowledging the alert; the alert stays in the Active Alerts list until it is cancelled.

## Acknowledge or cancel an alert

Acknowledging or cancelling an alert creates an entry in the Logging Service log file.

1. Select an alert in the Active Alerts list. You can select multiple alerts by pressing the Control or Shift key while clicking the entries in the list.
2. In the **Comment** box, enter any comment you want to appear in the log file with the entry for your action.
3. Click **Acknowledge Alerts** or **Cancel Alerts**.

## Cancelling and restarting TXPlay alerts

When TXPlay is the source service of an alert that you manually cancel, the Alerts Service does not generate any more alerts of the same type until you restart TXPlay.

For example, if you cancel a Schedule Empty alert for a playout channel, TXPlay stops the Alerts Service generating Schedule Empty alerts. If you want the Alerts Service to generate Schedule Empty alerts again, you need to restart TXPlay.



## Active Alerts pop-up layout

From the Active Alerts panel, you can display the Active Alerts pop-up layout:

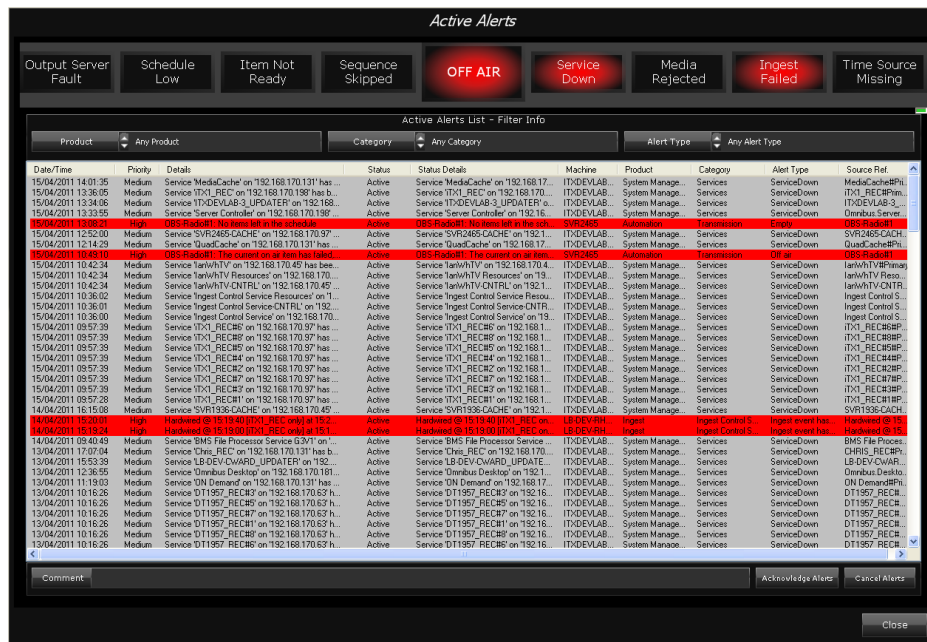

This layout contains a larger version of the Active Alerts list with filter boxes above it. By selecting filters in the filter boxes, you can simplify the list so that it contains only alerts that meet the filter criteria.

1. In the Active Alerts panel, click **Show Full Alerts List (Filterable)** to display the Active Alerts pop-up layout.

The full alerts list appears when Any Product, Any Category and Any Alert Type are selected in the **Product**, **Category** and **Alert Type** filter boxes.

2. Select filters to modify the list and view just the alerts that interest you.

## System Management pop-up layouts

Through the System Management buttons on the Engineering layout, you can select various pop-up layouts and use them for system configuration and administration:

Pop-up layout	Purpose
Channel Configuration	Configuration of channels of all types (playout, edit, etc.).
Channel View Management	Assigning of channels to channel views; and channel views to workstations.
Layout Management	Assigning of layout views to operators and workstations.
Routing Configuration	Configuration of the routing service.
Opus Administration	Administration tasks based on the OPUS 2 Service.
Colour Configuration	Specifying of colour-coding to the Schedule Grid.

Pop-up layout	Purpose
GPI Configuration	Configuration and testing of GPI services.
Name Rule Configuration	Creating and modifying of naming rules, used mainly in the naming of new clips.
Logging	Viewing and management of logs; insertion of manual entries in the Logging Service daily log file.
Security Tool	Management of the security of an iTX system.

## The Logging pop-up layout

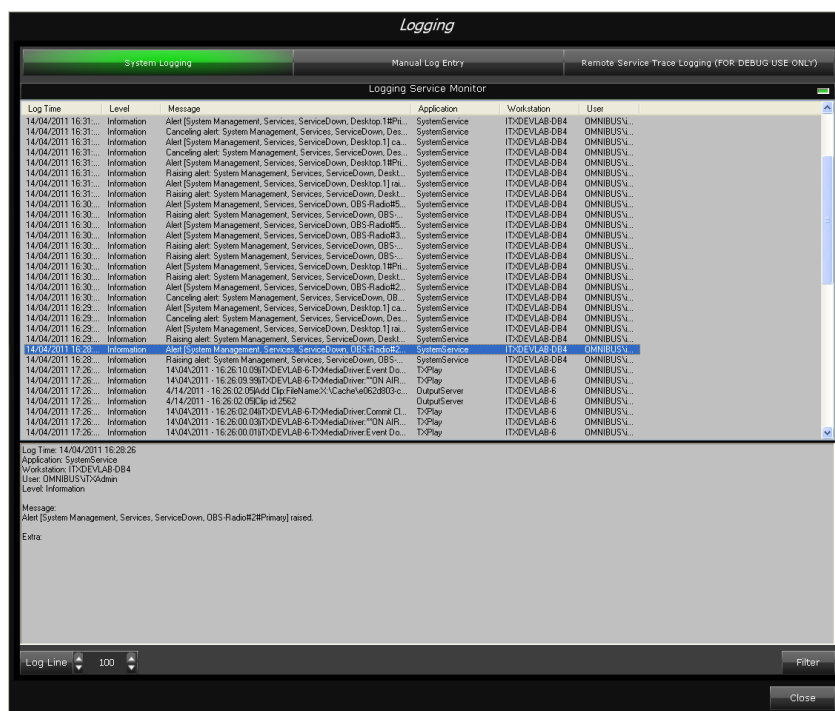

The Logging pop-up layout has three components:

- The Logging Service Monitor.
- The Manual Log Entry component.
- The Remote Service Trace Logging Monitor.

The Logging Service Monitor provides a live list of messages; it shows these messages as the Logging Service is processing them. It displays information in two panes: in the upper pane, log lines (brief descriptions of the conditions or events the messages relate to); in the lower pane, full details for any selected log line. You can scroll through the log lines to view recent messages, which the Logging Service stores in its log files.

Through the Manual Log Entry component, you can add your own log message to the Logging Service log file.

## Filtering log-message lists

As well as the message text, and the date and time of the message, an entry in the log-message list has these elements: the level of significance of the message; the workstation from which the message is generated; the user who is logged on at that workstation; the service or iTX Desktop that generates the message.

You can apply a filter to the live log-message list, to show only messages with log-element values that you specify in the filter.

You use the Logging Filter dialog to define a filter:



1. On the Logging Service Monitor, click **Filter**.

The Logging Filter dialog appears, with settings for a default filter.

The default filter allows all messages to appear in the log-message list: the **Any Level**, **Any Workstation**, **Any User** and **Any Application** buttons are all selected.

2. To modify the filter, do the following.
  - Click **Selection** for any element you want to specify values for. The associated **Select** button becomes enabled.
  - Click **Select** to display a list of values (e.g. user names) for the element.
  - Select only the values you want to appear in the filtered list.
  - Click **OK** to close the dialog.
3. Click **OK** to close the Logging Filter dialog.

The Logging Service Monitor displays the filtered log-message list.

## Creating a manual log entry

You can add your own logs to the Logging Service log file by using the Manual Log Entry component:



In creating manual logs, you can assign them to any of three log categories: Error, Information or Warning.

1. On the Manual Log Entry component, in the **Level** box, select a category for your manual log entry.
2. In the upper pane of the component, type a brief description of the log; in the lower pane, type the full details.
3. Click **Send**.

iTX enters your log in the Logging Service log file. It clears the Manual Log Entry component for the next manual log.

## The OPUS Administration pop-up layout

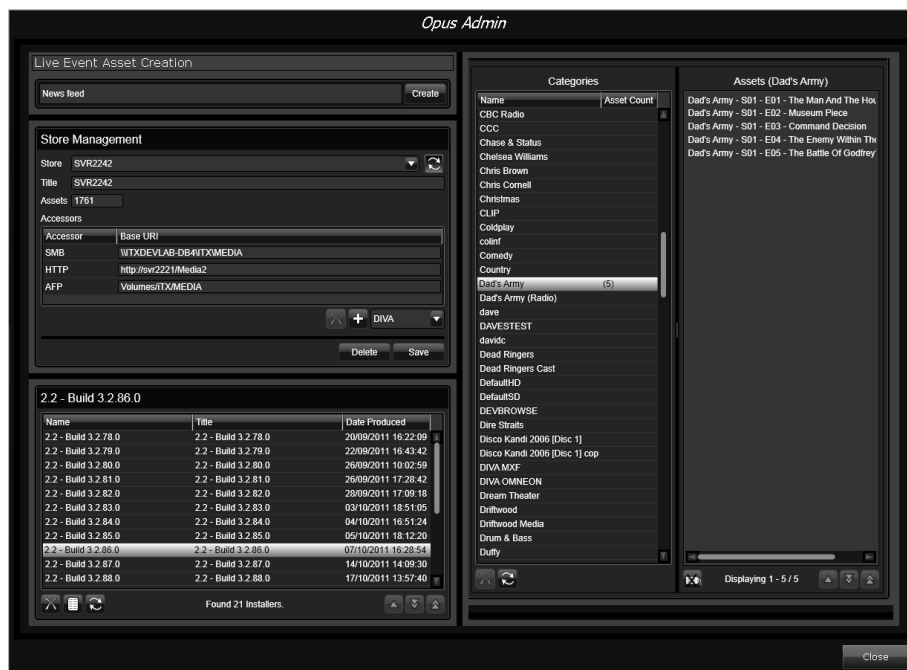

The OPUS Administration pop-up layout contains a number of tools that you use for tasks that involve the OPUS 2 Service.

- The Live Event Creator

- The Store Manager
- The Installer Manager
- The Category Manager

## Create a live event

The Live Event Creator provides one of two ways of creating live events in iTX. (The other way is for an operator to use the Save As option on the Asset layout, to save a copy of an existing live event.)

1. Enter a name in the text box of the Live Event Creator.
2. Click **Create**.

iTX creates a live event with the specified name.

## Using the Store Manager

The Store Manager holds a list of all the file stores in the iTX system. In general, these are the ones you configure under the Media Watcher Setup tab. You can select any of these and view certain details: the number of assets on the file store and the specified access path.

You can edit the access path and you can add details for other ways of accessing the file store (e.g. by using the HTTP protocol).

You can use the Store Manager to delete a file store from iTX. When you do this, you remove all asset location references to the deleted file store.

Store manager can also be used to delete entire stores, but the delete button will be greyed out for a store if there is media registered with iTX still existing on that store.

## Delete installation zip files

After an automatic upgrade of iTX, the installation Zip file stays in the Media folder on the main file store. The Installer Manager displays a list of such files and enables you to delete them.

1. Select an installation Zip file in the Installer Manager. You may select multiple files by pressing the Shift or Control key.

2. Click .

The Category Manager requests you to confirm you want it to delete the file.

3. Click **OK**.

The Category Manager deletes the file.

## Untag all assets from a category

You can untag all assets from a category in the Category Manager. You need to do this before you can delete the category.

1. Select a category in the Categories pane.

The Assets pane displays a list of assets tagged with the category.

2. Click .

The Category Manager requests you to confirm you want it to perform the untagging.

3. Click **OK**.

The Category Manager untags the category from all assets; it removes the assets from the Assets pane.

## Delete a category

In the Category Manager, you can delete a category when no assets are tagged with it.

1. Select a category in the Categories pane.
2. Click .

## The Naming Rule Configuration pop-up layout

The Naming Rule Configuration pop-up layout contains one component, the Naming Rule Administrator:



In a recording job, Ingest Manager creates a video clip for the media file it records onto an iTX Media Store. When it does this, it uses the OPUS 2 Service to name the clip. The service assigns names based on naming rules.

You use the Naming Rule Administrator to create, edit and manage the naming rules.

After you create a rule, it becomes available for operators to select for an instant ingest or a scheduled booking.

## Rule elements

A rule consists of elements, which you put together in the Naming Rule Administrator.

Available elements appear in the Rule Elements list. They are grouped into categories: Date, Time, Text and Sequence.

Some elements denote fixed text that appears in a name. Other elements are fields. A field is a space into which the OPUS 2 Service inserts text when it creates the name. For example, you use date and time fields where you want a name to include the date and time of the recording.

In defining a rule, you select the elements that you want it to include and add them to the Current Rule list. The **Preview** box displays the resulting name, using current values.

Usually, a name formed from a rule includes a fixed-text part and a field. The rule for this type of name can contain Text, Date and Time elements.

Example: Opening Ceremony 12/08 - 14:00

In this name, "Opening Ceremony ... - ..." is fixed text, while "12/08" and "14:00" are entries resulting from date and time fields.

A name may contain a sequence number: each time the OPUS 2 Service creates a name based on the rule, it increases the sequence number by one. The rule for this type of name includes a Sequence element.

Example: Opening Ceremony 001

In this name, "Opening Ceremony" is fixed text, while "001" is a number in an automatically generated sequence. The next clip is called "Opening Ceremony 002", and so on.

The OPUS 2 Service can generate a name containing text entered by an operator when the name is generated. A situation where this is useful is where a series of clips are created from the same source media. The name of each clip contains a common generic part, indicating the source; it also contains a short text segment that the operator enters to distinguish one clip from another. The rule for this type of name includes a Parameter Input element.

Examples: Opening Ceremony - Procession; Opening Ceremony - Guests

In these names, "Opening Ceremony - " is fixed text, while "Procession" and "Guests" are entered by the operator who creates the clips.

## Create a naming rule

1. Click **New Rule** on the Naming Rule Administrator, to display the Enter Name of New Rule dialog.
2. Enter a name for the rule in the **Rule Name** box; click **OK** to close the dialog.  
The name appears in the **Rule** box.
3. Add elements to the naming rule, as described below.
4. Click **Save** to save the rule.

## Add elements to a naming rule

You can add elements to a naming rule while it is selected in the Naming Rule Administrator.

1. If you want the generated name to include fixed text, do the following.

- In the Rule Elements list, expand the Text category and then click **Text** within this category; click  to display the Manual Text Properties dialog.
- Enter text in the **Text** box; click **OK** to close the dialog.

The text appears in the Current Rule list. The **Preview** box displays a sample name, resulting from the rule in its current state.

2. If you want the generated name to include a field-based part, do the following for each required field.
  - In the Rule Elements list, expand the Date or Time category; click the name of a field (any of the elements within these categories). You may select an individual date or time unit, or one of the pre-formatted set of units.
  - Click .

The field appears in the Current Rule list; multiple fields appear if you select one of the pre-formatted set of units. The **Preview** box displays a sample name, resulting from the rule in its current state.

3. If you want the generated name to include any of the available preset text characters (slashes, brackets or punctuation marks) do the following for each required character.
  - In the Rule Elements list, expand the Text category; click a preset character.
  - Click .

The character appears in the Current Rule list. The **Preview** box displays a sample name, resulting from the rule in its current state.

4. If you want the generated name to include a number that increments with each new name, do the following.
  - In the Rule Elements list, expand the Sequence category; click **Sequence**; click  to display the Choose A Sequence To Use dialog.
  - Select a sequence; click **OK** to close the dialog.

The sequence appears in the Current Rule list. The **Preview** box displays a sample name, resulting from the rule in its current state.



**Note:** You can create sequences in the sequence-management panel. See later in this section, “Create a sequence for an automatically generated name”.

5. If you want the generated name to include text entered by an operator at the time the OPUS 2 Service creates the name, do the following.
  - In the Rule Elements list, expand the Text category; click **Parameter: INPUT**; click  to display the Text Parameter Properties dialog.
  - In the **Text ID** box, enter the text label you want to appear on the Rule Text Parameter component – the iTX Desktop component that enables an operator to insert text in the automatically generated name.
  - In the **Character Mask** box, enter characters that you do not want the operator to be able to use (e.g. punctuation marks).
  - In the **Text Length** box, specify the maximum permissible number of characters in the operator text entry.
  - Leave the **Padding** button unselected (a red “x” is displayed) and the **Padding Text** box empty.



- Click **OK** to close the dialog.

The rule element appears in the Current Rule list. The **Preview** box displays a sample name, resulting from the rule in its current state.

6. If you want to re-position any of the rule elements in the Current Rule list, click its name and then either  or .
7. If you want to remove any of the rule elements from the Current Rule list, click its name and then .

## Create a sequence for an automatically generated name

When the same sequence appears in multiple naming rules, the sequence increments each time the OPUS 2 Service creates a name based on any of these rules. So, the names it creates for any one rule may not form a continuous series.

For example: If one rule includes fixed text “abc” and another includes fixed text “xyz”, and both use the same sequence, the OPUS 2 Service may generate a set of names like this: abc001, abc002, xyz003, abc004, xyz005.

If you do not want different naming rules to share a sequence, you may create a new sequence (instead of using an existing one) when you include a Sequence element in a naming rule.

To create, edit or delete a sequence, you use the features in the sequence-management panel on the Naming Rule Administrator:



1. Click **New** on the sequence-management panel to display the New Sequence dialog.
2. Do the following to set the sequence properties.
  - Enter a name for the sequence in the **Sequence Name** box.
  - In the **Zero Padding** box, select a value which causes the OPUS 2 Service to add zeros before a number, where necessary, to ensure that all sequence numbers have the required number of digits. For instance, specify a zero padding of 3 if you want the OPUS 2 Service to generate 3-figure sequence numbers: 001, 002, 003, ... 009, 010, 011 ... 099, 100, 101 ... etc.
  - Select a numbering format in the **Format** box. A base-10 sequence uses numbers only; a base-36 sequence contains numbers and letters.
  - In the **Reset Interval** box, select the interval after which the sequence should restart from 1.
3. Click **OK** to close the dialog.

The sequence becomes available for selection in the Choose A Sequence To Use dialog.

## The Colour Configuration pop-up layout

In the Schedule Grid on any iTX Desktop layout, iTX uses different colours to indicate the different status and time mode of events; it does the same for the Timeline Display. For example, iTX highlights an on-air event red.

The colours are defined in a colour scheme that is assigned to all channels in an iTX system (individual channels cannot have their own colour schemes).

You can modify the colour scheme by using the Colour Selector tool on the Colour Configuration pop-up layout:

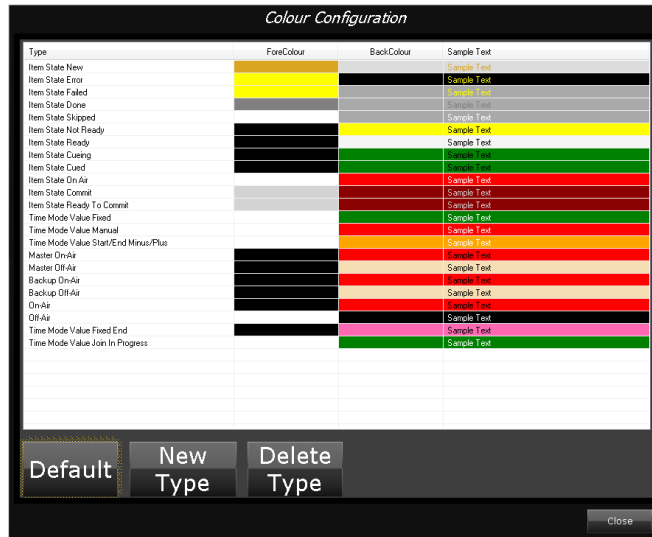

## Change the colour of a schedule event type

For each type of schedule event, you select: the text colour in the **ForeColour** box; the colour of the background strip in the **BackColour** box. iTX displays the text and background colours in the **Sample Text** box.

1. In the Colour Selector tool, click the **ForeColour** preview box for a schedule event type.  
Select the text colour through the Colour Selector. [More details](#), page 278.
2. Click the **BackColour** preview box for the schedule event type.  
Select the background colour through the Colour Selector. [More details](#), page 278.

## Add a new schedule event type

To identify categories of video clips (for example: commercials, programmes, branding) in the Schedule Grid and Timeline Display, you can add a new schedule event type to the Colour Selector tool.

1. Click **New Type** on the Colour Selector tool.  
The Colour Type dialog appears.
2. Enter the name for the event type in the **Name** box.
3. Click the **ForeColor** box.  
Select the text colour through the Colour Selector. [More details](#), page 278.
4. Click the **BackColor** box.  
Select the background colour through the Colour Selector. [More details](#), page 278.
5. Click **OK** to close the Colour Type dialog.  
The Colour Selector tool displays the new schedule event type.

**Note:**

- When an operator includes a video clip of a particular type in a schedule event, iTX displays the event in the event-type colour while the event status is "Ready" (the clip is available to play out). As iTX plays out a schedule, the event changes colour to indicate its current status (cued, on air, etc.).

**Delete a schedule event type**

You can delete any schedule event type in the Colour Selector tool.

1. Select an event type in the Colour Selector control.
2. Click **Delete Type**.

The Colour Selector tool removes the schedule event type.

**Restore the default colour scheme**

When you restore the default colour scheme, any schedule event types you added are removed.

1. Click **Default** on the Colour Selector tool.

The Warning dialog appears.

2. Click **OK** to close the Warning dialog.

The Colour Selector tool displays the default colour scheme.

**The Colour Selector**

You display the Colour Selector by clicking a **ForeColour** or **BackColour** preview box when working with a schedule event type:

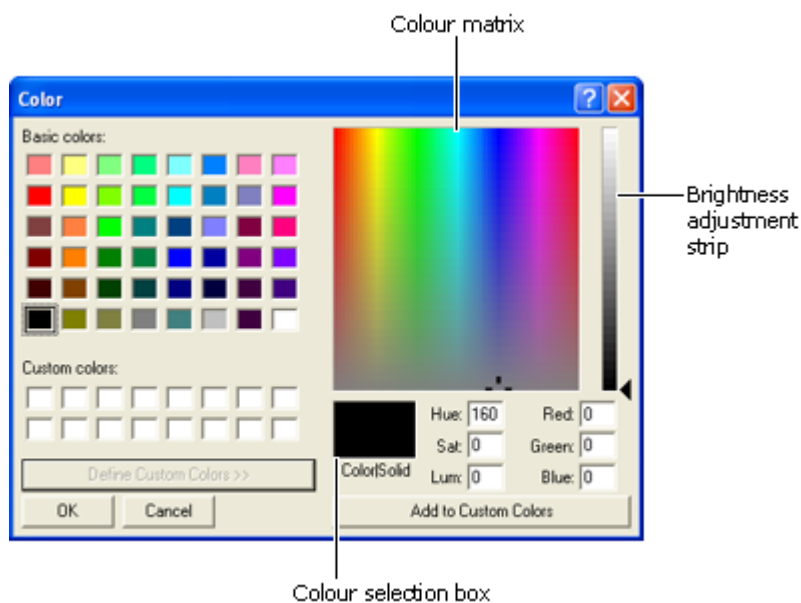

## Use the Colour Selector

1. Click **Define Custom Colours** to expand the Colour Selector.  
This button is inactive when the Colour Selector is expanded.
2. Do one of the following to select the text colour.
  - Click one of the basic colours.
  - Click a custom colour if you have stored any.
  - Click a point in the colour matrix.
  - Click a point in the brightness adjustment strip, or drag the slider.
  - Use the boxes to change the value for Hue, Saturation, Luminosity, Red, Green or Blue.
 The selected colour appears in the colour selection box.
3. If you want to store a custom colour, click **Add to Custom Colours**.
4. Click **OK** to close the Colour Selector.

## The Server Manager layout

The Server Manager layout contains a single component – the Server Manager:

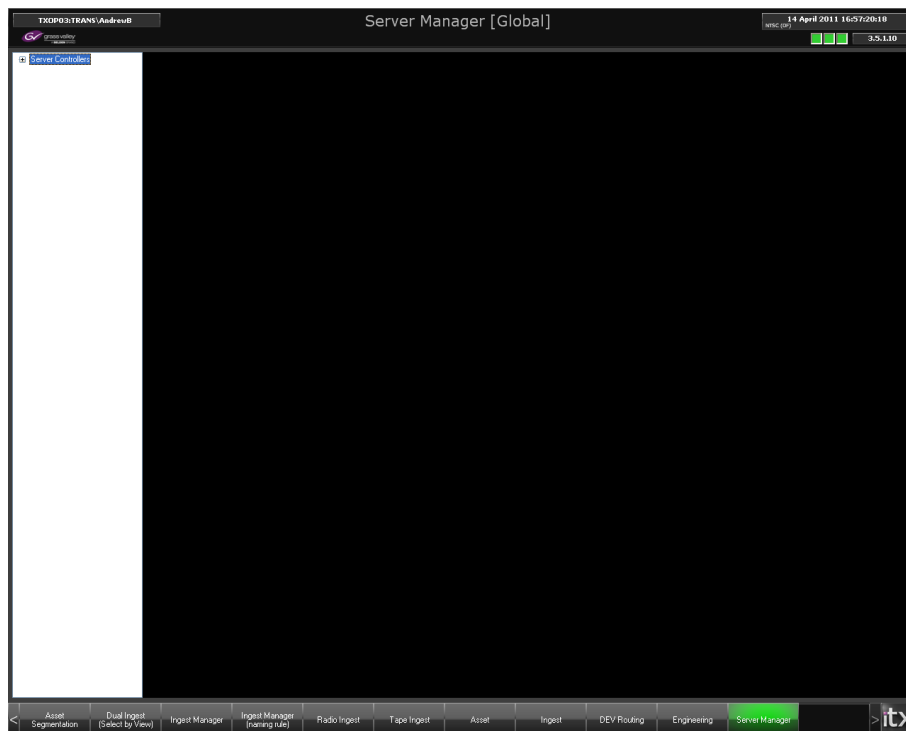

## About the Server Manager

The Server Manager can manage the Server Controllers in an iTX system. If you have the Service Manager and Service Administrator security attributes, you can use the functionality of a Server Controller from within the Server Manager. [More details](#), page 61.

You register a Server Controller with the Server Manager and connect to it. You can then perform a number of tasks: start and stop managed services; configure these services; view and capture service logs.

Without the Service Manager and Service Administrator security attributes, you can connect to Server Controllers from the Server Manager and view their configuration details.

## Register and connect to a Server Controller

Before you can access a Server Controller from within Server Manager, you need to register the Server Controller and connect to it.

1. In the left pane of the Server Manager, right-click **Server Controllers** and select **Register New Server Controller** from the displayed menu:

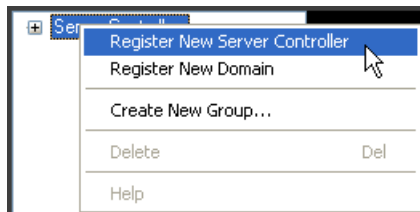

The Register New Server Controller dialog appears.

2. Do the following to register a Server Controller with the Server Manager.
  - Click **Browse** to open the Browse Server Controllers dialog. The dialog contains a list of the IP addresses of the Server Controllers in the iTX system.
  - Select a Server Controller by selecting its IP address from the list; click **OK** to close the dialog. The IP address appears in the **Server Controller** box.
  - Click **OK** to close the Register New Server Controller dialog.

An entry for the Server Controller (its IP address) appears in the Server Controllers list.

3. Right-click the entry and select **Connect** from the displayed menu:

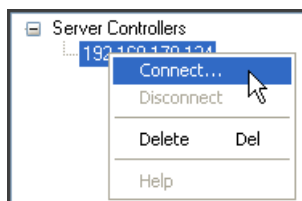

The Server Manager connects to the Server Controller. You can view a list of the services that are registered with this Server Controller by expanding the Server Controller entry:

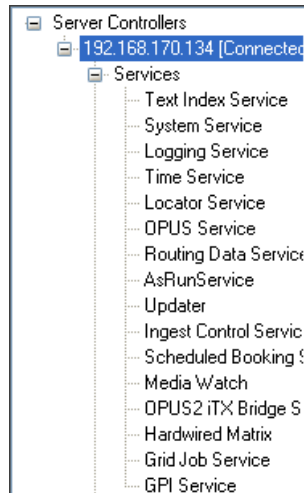

4. Click the name of any service in the list to view its properties:

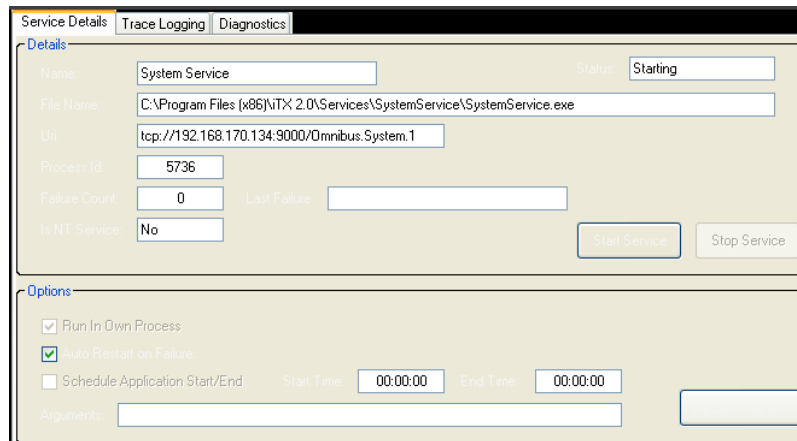

To view the information under the Trace Logging tab, you need to select **Activate Service Logs** under that tab.

# Upgrading or uninstalling iTX software modules on single machines

When you upgrade a single machine in your iTX system, or uninstall iTX software from it, you run the iTX installer from the installation folder (iTX Suite).

The installer checks each module that is installed on the machine; it notes what components are in the module, and what their version numbers are. It compares these details with those for the same module in the installation folder. By doing this, it determines if any action is required.

- If a module in the installation folder contains extra components, or new versions of installed components, the iTX Installer dialog displays the names of the relevant components in the action list and specifies the required action (install or update):

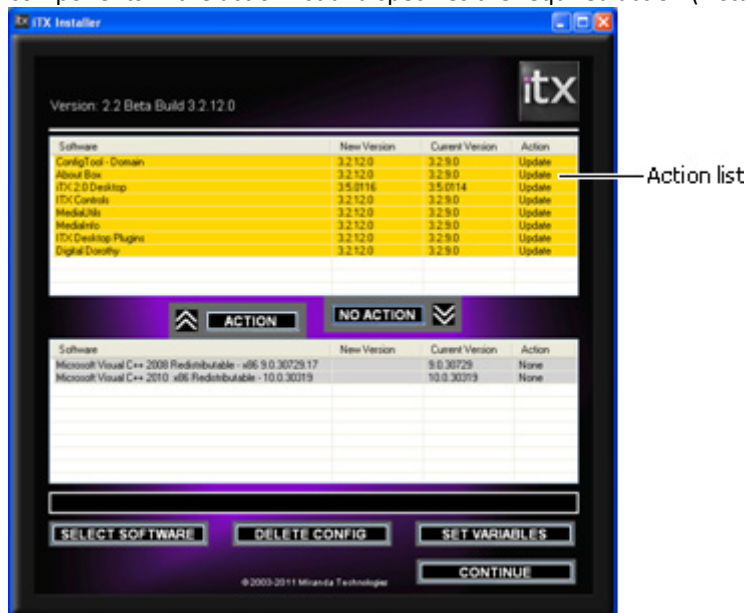

- If there are no differences between the two sets of components, the iTX Installer dialog displays a blank action list.

Installed components that are current appear in the no-action list.

You can move components from one list to the other by selecting them and clicking **Action** or **No Action**. If you move installed components into the action list, the installer automatically specifies "uninstall" as the required action.

When there are components in the action list, the dialog displays the **Continue** button. Clicking the button causes the installer to perform the specified actions. In this way, you can use the installer to update or uninstall a module.

When there are no components in the action list, the dialog displays the **Finish** button. Clicking this closes the dialog.

## Upgrading an iTX software module

You can upgrade any machine in your iTX system by running the iTX installer from the installation folder (iTX Suite) with the latest versions of the software modules.

To simplify an upgrade, the installer uses its configuration file to automatically select the required software modules. [More details](#), page 30. Wrrerwetr

## Upgrade an iTX software module

1. Download the zip file from the Grass Valley website and copy it to the computer you wish to install iTX on.
2. Depending on the security settings of your computer, you might need to make sure that the installation process will not be blocked as potentially dangerous. Right click the zip file and select 'properties'.
3. From the properties menu, select the **General** tab. If the computer is configured to block the installation of files that could be harmful, the bottom section of the menu will have a Security statement: "This file came from another computer and might be blocked to help protect this computer". Click **Unblock** then **OK**.

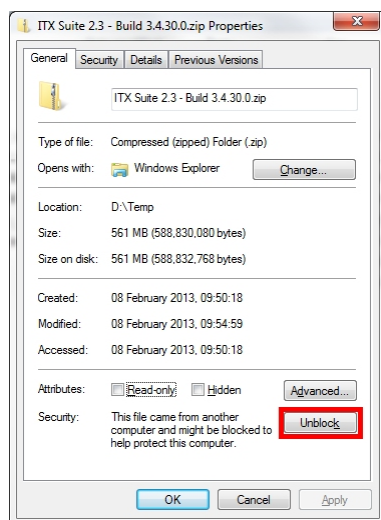

4. Extract the zip file's contents into the directory you wish to install the software from.  
**NOTE:** You must be logged on to the local machine with administrative user rights in order for the installation process to continue successfully.
5. Open the iTX suite folder and right-click **Setup.exe**. Select 'Run as Administrator' if this option is available. If not, simply double-click the Setup.exe to begin the installation process.

The iTX Installer dialog lists the components for the modules that are installed on the machine. In the action list, it displays new components that are in the installation folder, these are marked for "Install" or "Update". In the no-action list, it displays components that are up to date.

6. If you want to add or remove any module, do the following.
  - Click **Select Software** to display the Select Software to Install dialog.
  - Ensure the check boxes for the software modules you want to install are selected; clear the check boxes of software modules you do not want to install.
  - Click **OK** to close the dialog and return to the iTX Installer dialog.
7. Check the action list in the iTX Installer dialog. Ensure it contains only components that you want the installer to perform an action on. If necessary, remove components from the list by selecting them and clicking **No Action**.



8. Click **Continue**.  
The installer installs the new components.
9. Click **Finish** to close the iTX Installer dialog.

## Uninstalling an iTX software module

In using the iTX installer to uninstall a software module, you select the module components in the iTX Installer dialog. There are two ways of doing this:

- The best way is to use the iTX installer to select the components automatically.
- Alternatively, you may select components manually.

### Prepare to uninstall a software module by using the iTX installer to automatically select components

This procedure depends on the availability of the installer configuration file. [More details](#), page 30.

1. In the iTX installation folder, double-click **Setup.exe** to start the iTX installer.  
The iTX Installer dialog lists the components for the installed modules. Components that you can uninstall appear in the no-action list. Other components marked for installing or updating may appear in the action list.
2. Do the following to prepare the installer to uninstall the components of an installed software module.
  - Click **Select Software** to display the Select Software to Install dialog.
  - Clear the check box of the software module you want the installer to uninstall.
  - Click **OK** to close the dialog.

In the iTX Installer dialog, the action list shows the components that are to be uninstalled.

### Prepare to uninstall a software module by manually selecting components

In this procedure, you may select the components of more than one iTX software module.

1. In the iTX installation folder, double-click **Setup.exe** to start the iTX installer.  
The iTX Installer dialog lists the components for the installed modules. Components that you can uninstall appear in the no-action list. Other components marked for installing or updating may appear in the action list.
2. Do the following to prepare the installer to uninstall the components of any installed software module.
  - Select the components in the no-action list. Press Shift or Control to select multiple components together.
  - Click **Action** to move the components to the action list.

The installer marks the components for the action "Uninstall".

## Uninstall components of an iTX software module

1. Do one of the following to select the software module you want the iTX installer to uninstall.
  - Use the iTX installer to automatically add the module components to the action list.
  - Manually select the module components and move them to the action list.
2. Check the action list. If necessary, remove components from the list by selecting them and clicking **No Action**.
3. Click **Continue**.

The installer uninstalls the selected components.

After removing manually selected components (but not those selected automatically by the installer), it leaves them in the action list; they appear marked for "Install".

**Note:** If you click **Continue**, the installer re-installs these components.

4. Do one of the following to close the iTX Installer dialog.
  - Click the close button in the upper, right corner of the dialog.
  - Move all components into the no-action list; then click **Continue**.

## Installing a different type of iTX software module on a machine

The installer configuration file identifies a machine as a particular type of iTX machine (Database Server, Output Server, etc.). [More details](#), page 30.

There are two ways in which you can change the machine type (for example, from an Output Server to an Encode Server):

- You can uninstall the current module, manually delete the configuration file and then install a new module.
- You can replace the current module with one for a different type of machine. By doing so, you overwrite the configuration file.

### Manually delete the installer configuration file

1. After uninstalling an iTX software module, click **Delete Config** in the iTX Installer dialog.

The installer deletes the configuration file. It then displays the Select Software to Install dialog, from which you can install any iTX software module.

### Replace an installed iTX software module with a module of a different type

1. Double-click **Setup.exe** to start the iTX installer.

The iTX Installer dialog lists the components for the installed modules.
2. Click **Select Software**.

The installer displays the Select Software to Install dialog.

3. Do the following to specify the replacement details in the Select Software to Install dialog.
  - Ensure the check boxes for the software modules you want to install are selected; clear the check boxes of software modules you do not want to install.
  - Click **OK** to close the dialog.

In the iTX Installer dialog, the action list shows the components that are to be installed and those that are to be uninstalled.

4. Click **Continue**.

The installer uninstalls one software module and installs the other.

5. Click **Finish** to close the iTX Installer dialog.

## Migrating between Output Server 1 and Output Server 2

For information on migrating from Output Server 1 to Output Server 2 or vice versa, see the *Output Server 2 Channel Configuration Guide*.

# Upgrading a batch of iTX server machines

For the first installations of iTX software modules on server machines (i.e. machines on which iTX services run), you manually run the iTX installer on each machine. After this, you can easily upgrade all the server machines together in an automatic process when you receive new versions of iTX software.

The functionality for automatic batch upgrading is provided by two special iTX software applications:

- An iTX system-management tool called the Software Distributor, which you open on your system-administrator workstation.
- An iTX service called the iTX Software Updater. This is installed on each iTX server machine the first time you run the iTX installer; it runs under the control of the Server Controller.

## The Software Distributor

You manage the upgrade process from the Software Distributor window. This gives details of the server machines in your iTX system, their installed software modules and available iTX installation folders. The details appear under the Distribution tab:

iTX installation folders on the Media Store

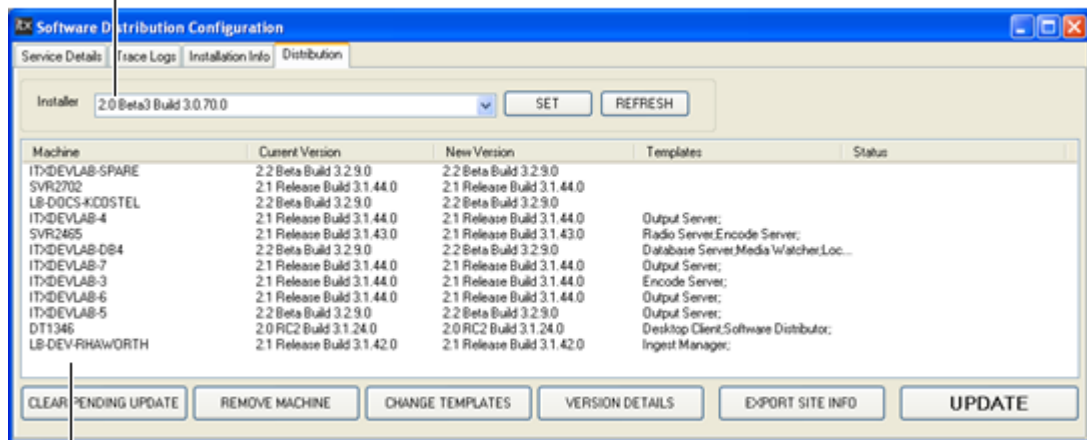

iTX server machines and their software versions

By using the features of the Software Distributor window, you assign the latest software modules to the various machines and start the upgrade.

If problems arise after an upgrade, you can restore a machine to a previous state by installing any of the earlier software modules.

## Registering of iTX installation folders

In the **Installer** box of the Software Distributor window, you select an installation folder from a list of all such available folders.

To be included in this list, an iTX installation folder must be registered in the System Database. Registration happens when you place the iTX installation folder, in the form of a Zip file, in the Inbox folder on the Media Store.

The Media Watcher registers the iTX installation folder. It then moves it to a folder, named "Zip", in the Media folder.

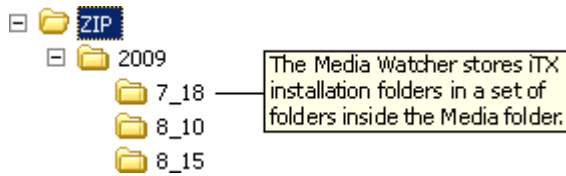

## The iTX Software Updater

The iTX Software Updater is a service that runs on each iTX server machine. In response to update requests, it performs actions that cause the updates to happen.

The Software Updater:

- Downloads the specified iTX installation folder from the Media Store; it stores it in a local folder used for temporary items.
- Starts a system process to run the iTX installer.
- Stops the iTX services and then the Server Controller on the machine.

When the Server Controller stops, it stops the Software Updater. The iTX installer runs and installs the selected software modules. After this, the Server Controller starts. This, in turn, starts the Software Updater and the updated iTX services.

On starting, the Software Updater creates a record of the installed components and tidies up the installation files: it deletes the downloaded iTX installation folder and any temporary files used in the installation.

## Setting up and running an automatic batch upgrade

To set up and run an automatic batch upgrade, you:

- Register the new iTX installation folder in the System Database.
- Specify the upgrade requirements in the Software Distributor window.
- Start the upgrade.

Before or after an upgrade, you may create an installation report for your iTX system. An installation report lists all the components in the software modules that are installed on the server machines.

## Register a new iTX installation folder

1. Copy the Zip file that contains the iTX installation folder to the Inbox on the Media Store.  
The Media Watcher registers the iTX installation folder in the System Database and moves the Zip file to a folder in the Media folder.

## Specify upgrade requirements and start an upgrade

1. Start the Software Distributor on your iTX Desktop.
2. Do the following to assign an iTX installation folder to a batch of machines.
  - In the system-information pane of the Software Distributor window, select the machines you want to upgrade:

Machine	Current Version
ITXDEVLAB-1	1.3 RC5 Build 2.2.45.0
OMNIBUS-1700860	1.2 RC3 Build 2.1.118.0
ITXDEVLAB-DB2	1.3 RC5 Build 2.2.45.0
ITXDEVLAB-SPARE	1.2 Release Build 2.1.148.0
DT1490	1.3 RC4 Build 2.2.41.0
SVR2039	1.3 RC5 Build 2.2.45.0

You can select multiple machines by using the Control or Shift key.

- Select an iTX installation folder in the **Installer** box.
- Click **Set**.

The New Version column of the system-information pane shows the version number of the selected iTX installation folder:

Machine	Current Version	New Version
ITXDEVLAB-1	1.3 RC5 Build 2.2.45.0	1.3 RC5 Build 2.2.45.0
OMNIBUS-1700860	1.2 RC3 Build 2.1.118.0	1.3 RC5 Build 2.2.45.0
ITXDEVLAB-DB2	1.3 RC5 Build 2.2.45.0	1.3 RC5 Build 2.2.45.0
ITXDEVLAB-SPARE	1.2 Release Build 2.1.148.0	1.3 RC5 Build 2.2.45.0
DT1490	1.3 RC4 Build 2.2.41.0	1.3 RC4 Build 2.2.41.0
SVR2039	1.3 RC5 Build 2.2.45.0	1.3 RC5 Build 2.2.45.0

3. For each machine you want to upgrade, do the following to specify the software modules to include in the upgrade.
  - Select the machine in the system-information pane. You may select multiple machines if they are to receive the same modules.
  - Click **Change Templates** to display the Change Template dialog. This contains two panes: one for available templates (on the left) and one for selected templates (on the right). A template in this case defines the components in an iTX software module.
  - Select one or more templates in the available-templates pane and click **Add** to add them to the selected-templates pane. (You may remove any template from the selected-templates pane by clicking **Remove** after selecting the template.)

The Templates column of the system-information pane shows details of the selected modules.

4. Click **Update** to start the upgrade.

As the upgrades happen, the Status column in the system-information pane shows the current state of the process on each machine. You may monitor installer activity on any machine by viewing the iTX Installer dialog on that machine.

5. Once the upgrade is finished, close the Software Distributor.

**Note:**

- In the Software Distributor window, you can cancel your selections by clicking **Clear Pending Update** instead of starting an update.
- You can remove any machine from the system-information pane by selecting it and clicking **Remove Machine**. You may want to do this to delete entries for machines that are no longer in your system but are still listed.
- You can find out what versions of components are installed on any selected machine by clicking **Version Details**.

## **Create an installation report**

1. In the Software Distributor window, click **Export Info**.  
The Windows Save As dialog opens.
2. Enter a name for the installation report; select a folder in which to store it; click **Save**.  
The Software Distributor creates a file with the filename extension ".site". You can open the report in any standard text editor, such as Microsoft Notepad or Microsoft Word.

# Closing down your iTX system

## Closing down an iTX Desktop

When you close the iTX Desktop at a workstation, the services continue to run; so schedules continue to play out in channels.

1. To close the iTX Desktop, right-click the title bar or the iTX logo; select **Exit** from the displayed menu.

Click **Yes** when a dialog appears requesting you to confirm you want to close the iTX Desktop.

## Closing down a server machine

1. If you want to stop all the services running on a particular machine, close the Server Controller on that machine.
2. If you want to stop any individual service, do the following.
  - Select the Controlled Services Information tab in the Server Controller window.
  - Right-click an entry in the controlled services list; click **Stop Service** from the displayed menu.

The Server Controller stops the service. You can restart the service by right-clicking the service entry and selecting **Start Service** from the displayed menu.



## System resilience

An iTX system supports various levels of back-up protection, to ensure a schedule continues to play out, or clips continue to be ingested, if some part of the system fails. You can set up a system to minimise disruption if there is a failure in any of these parts:

- The Database Server.
- An Output Server.
- An Encode Server.
- Media Store.

Also, you can:

- Set up an iTX system to supply the same live source to main and back-up Output Servers.

## Service resilience modes

There are two ways of setting up services to ensure a system can handle the failure of any service. Which one you use for a particular service depends on how the service is designed to work.

- In a **load-balanced** arrangement, two or more instances of a service run on separate machines. These share the service tasks between them. Each service has equal status. If a service fails, tasks are automatically allocated to the other service(s).
- In a **primary-backup** arrangement, you run two instances of a service on separate machines. One has the status of a primary service; the other, the status of a back-up service. The primary service performs all the service tasks; the back-up service runs without performing any service task. If the primary service fails, the back-up service takes over the primary role. If the original primary service becomes available again, it performs the role of a backup service.

Services that work in a load-balanced arrangement are: the System Service; the Locator Service; the OPUS 2 Service; the GPI Service.

Services that work in a primary-backup arrangement are: the Logging Service; the Time Service; the Routing Data Service; the As Run Service; the Hardwired Router; Missing Materials Manager; TXPlay.

For a small number of services, it is not possible to run two instances at the same time. These are services that use system information that they hold in their own memory; the services load the information, which is stored in the System Database, when they start. If any of these services fail, you need to start a backup service manually. The services that behave in this way are: the Scheduled Booking Service; the Ingest Control Service; the OPUS.Interchange Event Booking Service.

Where a system includes multiple Media Watchers, each one must be set up to operate independently and without interfering with the operations of the others. You cannot run Media Watchers in a primary-backup arrangement.

## Configuring resilience modes

Services that are designed to run in load-balanced mode do so automatically; no configuration is needed.

For a primary-backup arrangement, the primary service requires no configuration. For the back-up service, you need to enter the command-line parameter "-backup" in the Server Controller Configuration window. [More details](#), page 215.

## Checking the resilience mode

You can check the resilience mode of a service in the service window. The illustrations show a load-balanced System Service and a primary Routing Data Service:



## Redundancy options

### System Database

For the Database Server, you may run a back-up machine in parallel with the main one. Both machines run Microsoft SQL Server and the iTX services.

You use SQL Server functionality (either clustering or mirroring) to keep the main and back-up System Databases synchronised. If you use SQL Server mirroring functionality, the witness SQL Server runs on another machine in your iTX system (for example, the Time Server machine).

For more information about SQL Server clustering or mirroring functionality, see the Help information for SQL Server or contact iTX Support.

### Output Server

An Output Server has some built-in redundancy: it has a local cache in which it keeps copies of media files that are in its current schedule. So long as the required files are in the cache, the Output Server can play out a schedule even if the Media Store or the System Database goes offline.

To cover for the potential failure of an Output Server, you may use either of two methods:

- For each channel, run a back-up Output Server in parallel with the main Output Server. The back-up machine plays the same schedule as the main one, which delivers the content for transmission.

Such a set-up is often called an  $N + N$  system; for any number of main Output Servers there is an equal number of back-up Output Servers.

- Have a standby Output Server, ready to replace any main Output Server that fails. The standby machine runs the playout services but with no schedule loaded while all main Output Servers are working. If an Output Server fails, the standby machine loads and plays the schedule that the failed machine was playing (starting at a point within a clip, if necessary).

Such a set-up is often called an  $N + 1$  system; for any number of main Output Servers there is just one standby Output Server.

In an N+N system, iTX can operate a matrix router to connect the back-up Output Server instead of the main Output Server to the transmission system.

In an N+1 system, you manually fail over to the standby server and TX Play will automatically load a schedule in the standby Output Server; you then operate a router to switch the standby Output Server instead of the main Output Server to the transmission system. You may do this either from within the iTX system or outside of it.

## Configuring an N+1 Server

Because the 'standby' server may be used to take over from any of the main output channels in the event of an on air failure, when installing the Output Server services, a generic configuration and channel name is used, such as 'standby 1' and then the channel configuration required can be loaded at the time it is required to take over.

This can be done in one of two ways – either directly from the Output Server itself by running the iTXChannelConfig.exe program and manually entering the details (Start > All Programs > iTX 2.0 > TX Play Config) or remotely using a Windows Batch file executable script that copies the required channel config from an XML file into the actual TX Play Config file and then runs the Output Server software for you.

This operation can be carried out via a special iTX Desktop Layout called 'Back Up Channel Assignment'. The operator then waits for the service indicator lights to go green on the Output Server status display component and then manually switches the standby server into the 2transmission circuit.

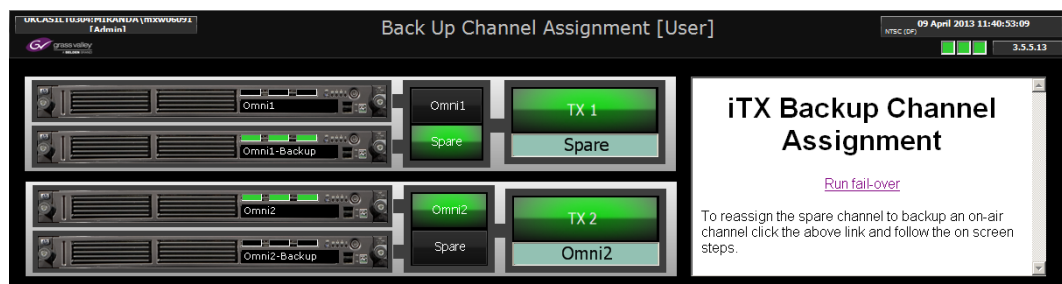

To fail over to a back-up server using this procedure:

1. Click 'Run Fail-over' on the right hand side. This runs a preconfigured locally stored batch file that contains details of all your iTX channels and the network connection credentials of the standby server. You then follow the on screen instructions from a windows command prompt box.
2. The batch file scans a local folder that contains copies of all your iTX channel configuration files in XML format. The command prompt will then list all of the channels it has found configuration files for and prompt you to enter the name of the channel you wish to fail over. Type the name of the channel and hit 'return'.

3. The command prompt will then confirm the name of the chosen channel and ask the question 'Activate config for (channel name) on back up machine (Y/N)? check the name is correct and hit 'Y' if you wish to continue.
4. The batch file will then copy the xml configuration file into the TX Play folder on the standby server where the default configuration file is kept, overwriting it. It then restarts the Output Server services, forcing the channel to load the new configuration.
5. You then use the channel status indicator to observe the back-up server coming on line. When all the service lights are green and you are able to check the output server has loaded the correct schedule and begun to play out, you manually route the standby channel into your transmission circuit, using the routing controls on your Back Up Channel Assignment layout.

For more information on routing in an iTX system, see "Using iTX with a matrix router", page 304.

## Encode Server

For the Encode Server, you may run a back-up machine in parallel with the main one.

To cover for the potential failure of an Encode Server, you may use either of these methods:

- Use a tee connection to connect a feed to both the main Encode Server and the back-up Encode Server. This is the preferred method.
- Connect the main Encode Server and the back-up Encode Server to the same feed via two separate connections.

With either method, two files are created in the Media Store – one by each Encode Server; iTX considers both files to be the same. If the main file fails during playout, iTX continues playout with the back-up file.

## Media Store

The most common option is to use a mirrored RAID storage system to hold media files.

As another option, it is possible for a second complete iTX system to run in parallel with the main system. In this case, you may use the Media Watcher in one system to copy the contents of the main Media Store onto a back-up Media Store in the back-up system. [More details](#), page 92.

## Live Sources

The live source (usually from a satellite) is duplicated to produce two independent signals. One of the signals provides the main live source; the other, the back-up. The signals are connected to separate router sources. When a schedule event features the live source, iTX routes the main and back-up live sources to the main and back-up Output Servers.

iTX uses live aliases – alternative names for the router crosspoints – to identify the live sources. To allow it to treat the two separate signals as the same live source, the live aliases must be identical for both sources. [More details](#), page 301.

## Running a back-up Database Server

On a back-up Database Server machine, you run both a back-up System Database and a set of iTX services.

### Back-up System Database

You use Microsoft SQL Server functionality (either clustering or mirroring) to keep the back-up System Database synchronised with the main System Database.

### Back-up system services

You run a duplicate set of iTX services in parallel with the main iTX services. Some may run in load-balanced mode and perform tasks in the system. You configure others to run in back-up mode; any of these becomes active only if the corresponding primary service fails.

### Preparing a back-up Database Server

The machine that you use as a back-up Database Server should have the same technical specification as the main Database Server machine. It must also have a static IP address for its network connection.

Just as iTX services that need to contact a primary Locator Service do so by using the host name "omn-locator", those that need to contact a back-up Locator service use the host name "backup-locator". To enable them to do so, you need to map this host name to the IP address of the back-up Database Server in local-machine Hosts files or on a WINS or DNS server.

If you intend to run a back-up System Database, you must install Microsoft SQL Server on the back-up Database Server before installing the iTX software.

### Set up a back-up Database Server to run the iTX services

1. Do one of the following, depending on which method your iTX system uses to resolve host names.
  - Enter the IP address of the back-up Database Server for the host name "backup-locator" on a WINS or DNS server.
  - On each machine in the iTX system, enter the IP address of the back-up Database Server for the host name "backup-locator" in the local Hosts file. You need to do this for the main Database Server and Media Store, and for all Output Servers, Encode Servers, and Desktop Client workstations.
2. On the back-up Database Server machine, install the Database Server module.
3. Add the `-backup` start-up parameter in the configuration of the iTX services that are to run as back-up services. [More details](#), page 215.

No configuration is necessary for load-balanced services.

## Configuring the System Service to use the back-up Database Server

When you use Microsoft SQL Server mirroring functionality to keep the back-up System Database synchronised with the main System Database, you need to configure the System Service on the main Database Server machine to use the back-up Database Server.

You do this by entering the name of the back-up machine in the **Backup Database Server** box in the Database Configuration dialog:

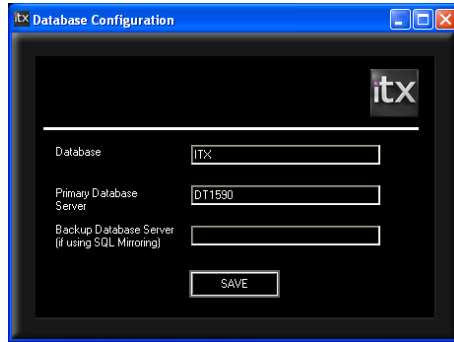

The dialog appears when you install the Database Server module. You can display it after installation by running the System Service Configuration tool (ObjectDatabaseConfig.exe).

The tool is stored in the folder:

C:\Program Files (x86)\iTX 2.0\Services\SystemServiceConfig

## Running a back-up Output Server

### Master and slave channels

Two Output Servers, one main and one back-up, operate a pair of master-slave playout channels: the main Output Server provides the master channel; the back-up Output Server, the slave channel. iTX plays out the schedules in both channels at the same time.

Normally, the output signal from the main Output Server is delivered to the transmission system through a matrix router; the back-up Output Server is connected as an alternative router source. The diagram shows this arrangement:

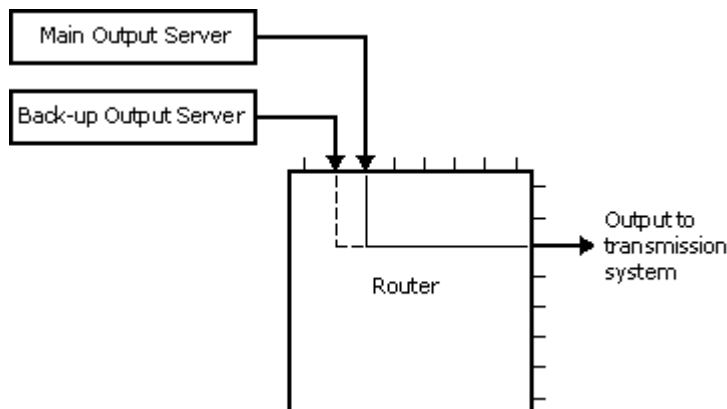

The router destination to which the transmission system is connected is used to define the master channel – i.e. the channel that is routed to this destination is the master channel. You specify the destination when configuring the channel. [More details](#), page 142.

When an operator creates or loads a schedule in a master channel, iTX loads a copy of the schedule in the associated slave channel.

If the operator edits the schedule in the master channel, iTX updates the schedule in the slave channel so that it matches the one in the master channel; it does this after a short delay (about 30 seconds) to allow the operator to correct any editing errors.

The schedule in a slave channel cannot be edited directly.

The Schedule Grid on the Channel Control layout displays a label that shows whether a selected channel has master or slave status.

If the option to produce an as-run log is selected for the channels, only the master channel writes the log.

## Failover of an Output Server

Depending on how you set up your system, iTX may respond to a failure of the main Output Server in one of two ways:

- It may automatically route the back-up Output Server instead of the main Output Server to the transmission system.
- It may wait for a manual command before routing the back-up Output Server to the transmission system.

For control of the router through iTX, the system must include certain routing services. When these services are running, you may manually operate the router from one of the system-administration layouts.

Where iTX does not control the router, you may manually operate the router through a third-party control panel, or you may use a signal-detection device to perform the task automatically.

## Use of a dummy router to identify the master channel

When iTX is set up to operate a matrix router, it monitors the router operations and automatically detects which channel is the master channel.

For a system in which routing happens outside of iTX control, iTX needs another way of finding out which is the master channel. For this, you need to set up a dummy router. This is a software application that provides routing status information to iTX. The information relates to crosspoints that you configure in the dummy router: sources for the main and back-up Output Servers; a destination for the transmission system. [More details](#), page 318.

You can use router-control buttons on a system-administration layout to operate the dummy router so that the routing status of its crosspoints matches those of the real router. For example, on the dummy router, you may route the back-up Output Server source to the transmission-system destination.

By monitoring the status of the dummy router, iTX determines which is the master channel.

## Prepare the back-up Output Server cache

1. Ensure the cache partition for the back-up Output Server is separate to the machine C-drive and uses the same drive letter (for example, D:) as the cache partition on the main Output Server.

## Add a back-up Output Server 1 to an iTX system

1. On the back-up Output Server machine, run the iTX installer to install the Output Server module.

Follow the same procedure that you follow when installing the module on the main Output Server. [More details](#), page 41.

2. When the iTX Channel Config dialog appears, ensure you correctly identify the channel as back-up channel:

In the **Channel Name** box, enter the same name as that of the main channel and then add the suffix "-BACKUP" (in capital letters). There must be no space between the main-channel name and the suffix. For example, if the main channel is "iTX1", call the back-up channel "iTX1-BACKUP".

3. In iTX Desktop, on the Channel Configuration pop-up layout, do the following for both the main and back-up Output Servers.
  - Select **Master/Slave Setup** to set up a pair of master-slave channels. [More details](#), page 144.
  - Specify the router connection details for the Output Server.
  - Specify the router destination to which the transmission system is connected.
  - Select **Route on Failure** if you want iTX to route the back-up Output Server to the transmission system if one of the services (TXPlay) on the main Output Server closes down. Ensure this option is not selected if iTX is not set up for router control. [More details](#), page 148.

## Add a back-up Output Server 2 to an iTX system

For information on adding a backup Output Server 2 to an iTX system, see the *Output Server 2 Channel Configuration Guide*.

## Running a standby Output Server

A standby Output Server runs the iTX services with no schedule loaded. If a main server fails, you load its schedule into the channel of the standby Output Server. You operate a router to switch the output of the standby Output Server to the transmission system.

The arrangement is similar to that for a back-up Output Server:



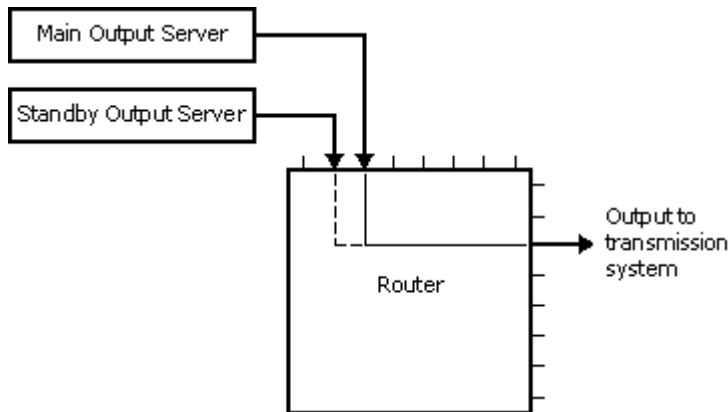

## Add a standby Output Server to an iTX system

1. On the standby Output Server machine, run the iTX installer to install the Output Server module.  
  
Follow the same procedure that you follow when installing the module on the main Output Server. [More details](#), page 41.  
  
When the iTX Channel Config dialog appears, enter a generic name for the channel: in the **Channel Name / Root Name** box; for example, "Standby Channel".
2. On the Engineering layout at an iTX Desktop Client system-administrator workstation, add an Auto Failover Control and connect it to the standby Output Server. [More details](#), page 120.
3. On the Channel Configuration pop-up layout, check the following is true for both Output Servers.
  - The **Master/Slave Setup** option is not selected. [More details](#), page 144.
  - The **Route on Failure** option is not selected. [More details](#), page 148.

### Note:

- If iTX is not set up to perform routing operations, you need to use the dummy router to provide routing status information. [More details](#), page 297.

## Failover a live schedule to a standby Output Server

If an Output Server fails, you need to failover its schedule to the standby Output Server.

1. In the **Channel** box of the Auto Failover Control, select the channel you want to run on the standby Output Server.
2. Click **FailOver**.  
  
iTX loads the schedule from the selected channel into the channel of the standby Output Server; it copies the required media files to the Output Server cache. It should be ready to start playing out the schedule after about 30 to 60 seconds.
3. Operate the router to connect the standby Output Server to the transmission system. If you are using a dummy router to give status information to iTX, operate this through a routing layout to reflect the operation of the real router.

## Running a back-up Encode Server

A back-up Encode Server runs in parallel with the main Encode Server, as shown by this diagram:

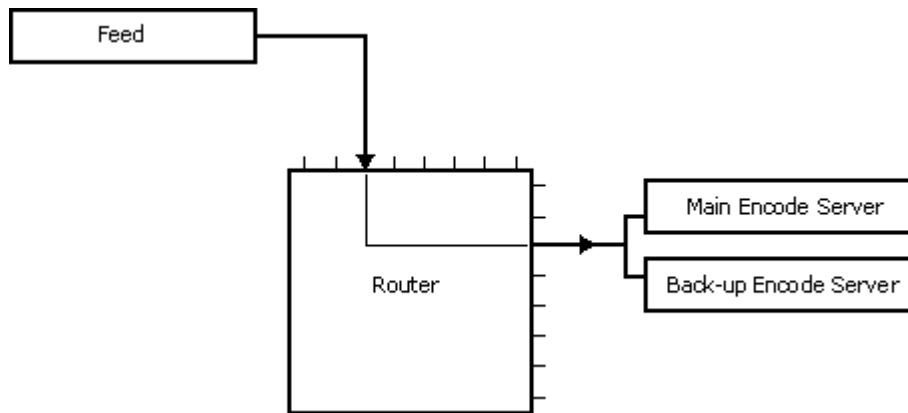

The feed is connected as a source on the router. Using a tee connection, the main and back-up Encode Servers are set up as router destinations. The router connects the feed to the main and back-up Encode Servers.

If you do not use a tee connection between the main and back-up Encode Servers, the servers must be connected to the same feed using two separate connections.

In either arrangement, each server creates a file in the Media Store. If the main file fails during playback, iTX will play the back-up file.

### Set up a back-up Encode Server

1. On the back-up Encode Server machine, run the iTX installer to install the Encode Server module.

Follow the same procedure that you follow when installing the module on the main Encode Server. [More details](#), page 47.

When the iTX Encoder Config dialog appears, ensure you correctly identify the recording channel:

- In the **Channel Name** box, enter the same name as that of the main recording channel but add the suffix "-BACKUP" (in capital letters). There must be no space between the recording channel name and the suffix. For example, if the recording channel is "ENCODER1", call the back-up channel "ENCODER1-BACKUP".

## Add a Output Server 2 simulcast channel to an iTX system

For information on adding a Output Server 2 simulcast channel to an iTX system, see the *Output Server 2 Channel Configuration Guide*.

## Duplicating a live source

The live source (usually from a satellite) is duplicated to produce two independent signals, as shown by this diagram:

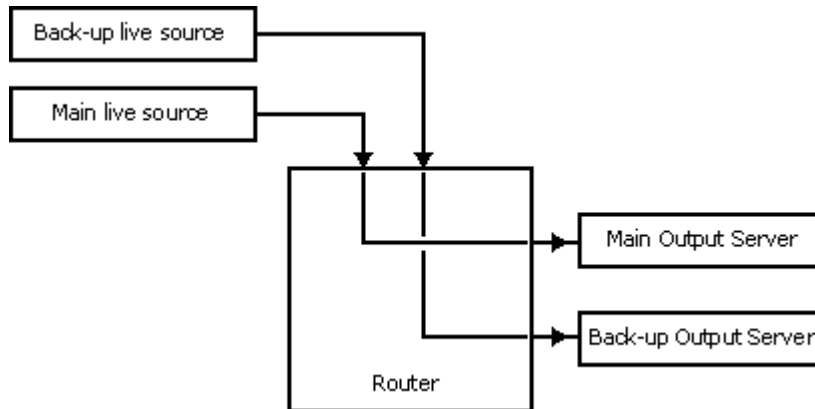

iTX uses live aliases – alternative names for the router crosspoints – to identify the live sources. To allow it to treat the two separate signals as the same live source, the live aliases must be identical for both sources.

For example, for the arrangement in the following diagram, the source crosspoint names are "Satellite 1" and "Satellite 2"; the live alias for each source is "Live Feed":

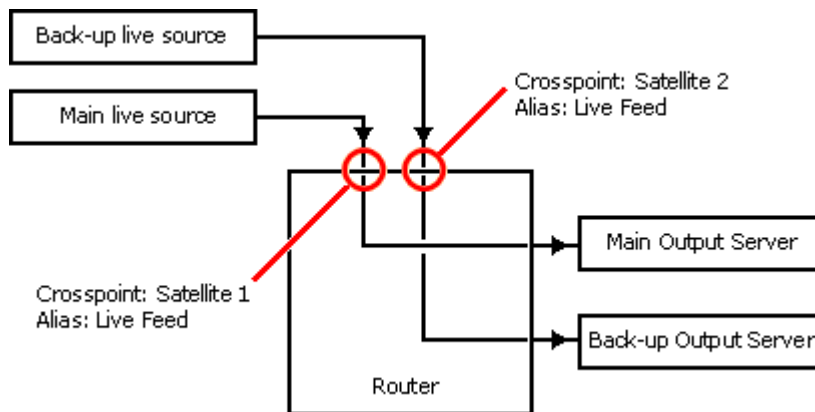

**Note:**

- A UMD alias may be assigned to any source or destination in the iTX system. The UMD alias, which identifies sources and destinations on iTX Desktop layouts, may be different to the live alias for a given source.

## Set up live sources

You set up live sources, and assign aliases to them, in the Live Event Configuration panel on the Channel Plug-in Configuration Tool:



1. Do the following to add live sources to the available-sources list in the Live Event Configuration panel.

- Click **Add/Remove** to display the Select Sources dialog.
- Select sources by adding them to the right pane of this dialog.
- Click **OK** to close the dialog.

The selected sources appear in the available-sources list.

2. Do the following to assign a live alias to a live source.

- Select a router source in the available-sources list.
- Click **Edit Live Alias** to display the Enter Alias dialog.
- Enter an alias in the **Alias** box.
- Click **OK** to close the dialog.

The alias appears in the Alias column next to the name of the selected source.

**Note:** After configuring live sources, you may need to refresh the Live Sources list on the Content Selector. You can do this by selecting a different channel view and then returning to the original one, or by restarting the iTX Desktop.

Once you have assigned live aliases to the sources on the main and back-up channels, the live sources appear in the Live Sources list in the Content Selector on the Channel Control layout:

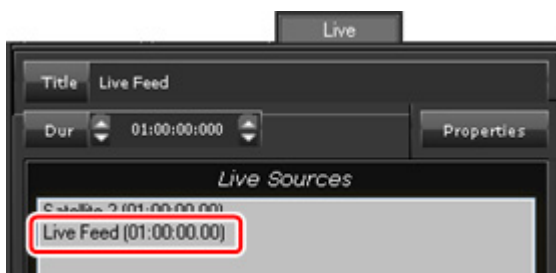

The Schedule Grid shows the live alias for a live event in the main playout channel:

+ 10:10:00.00	Video Clip	+	T	1	- Intro	Intro	00:05:30.00	Ready	WITXDEVLAB-DB2\ME
10:15:30.00	Video Clip	+	T	1	- Football Today	Football Tod	00:10:00.00	Ready	WITXDEVLAB-DB2\ME
10:25:30.00	Live	-	T	1	- Live Feed		00:00:59.28	Ready	Satellite 1
10:26:30.00	Sequence	-	-	1	- Commercial Break	Commercial	00:03:30.00	Ready	
10:30:00.00	Video Clip	+	T	1	- Golf - World Matchpl	Golf - World	00:20:00.00	Ready	WITXDEVLAB-DB2\ME
+ 10:50:00.00	Sequence	-	-	1	- Commercial Break	Commercial	00:03:30.00	Ready	
10:53:30.00	Video Clip	+	T	1	- Motor racing	Motor racing	00:20:00.00	Ready	WITXDEVLAB-DB2\ME
+ 11:13:30.00	Sequence	-	-	1	- Commercial Break	Commercial	00:03:30.00	Ready	

It shows the same live alias for the live event in the back-up playout channel:

+ 10:10:00.00	Video Clip	+	T	1	- Intro	Intro	00:05:30.00	Ready	WITXDEVLAB-DB2\ME
10:15:30.00	Video Clip	+	T	1	- Football Today	Football Tod	00:10:00.00	Ready	WITXDEVLAB-DB2\ME
10:25:30.00	Live	-	T	1	- Live Feed		00:00:59.28	Ready	Satellite 2
10:26:30.00	Sequence	-	-	1	- Commercial Break	Commercial	00:03:30.00	Ready	
10:30:00.00	Video Clip	+	T	1	- Golf - World Matchpl	Golf - World	00:20:00.00	Ready	WITXDEVLAB-DB2\ME
+ 10:50:00.00	Sequence	-	-	1	- Commercial Break	Commercial	00:03:30.00	Ready	
10:53:30.00	Video Clip	+	T	1	- Motor racing	Motor racing	00:20:00.00	Ready	WITXDEVLAB-DB2\ME
+ 11:13:30.00	Sequence	-	-	1	- Commercial Break	Commercial	00:03:30.00	Ready	

# Using iTX with a matrix router

## Setting up an iTX system for routing

### iTX router-control services

An iTX system may include a matrix router that is controlled through a device-driver application. iTX can operate the router by using a service to pass commands to the device driver:

- Where the device driver is a Grass Valley router-control application or a GVG Encore control system, iTX uses a service called the Router Bridge.
- For a GVG Acappella router, iTX uses a service called the GVG Acappella Router Server.
- For an NVision NV9000 router, iTX uses a service called the NVision NV9000 Router Control System Service.
- For an Evertz 7700 router, iTX uses a service called the Evertz 7700 Router Server.
- For an Evertz (Quartz) EQX router, iTX uses a service called the Quartz Router Service.

To make any of these router-control services available, you need to install the required component from the Routers module in the installation folder (iTX Suite):

- Router - Router Bridge.
- GVG Acappella Router.
- NVision NV9000 Router Service.
- Evertz7700 Router Service.
- Quartz Router Service.

### Dummy router

If a main Output Server in an iTX system fails, you may manually operate the router-control buttons on an iTX Desktop layout to connect a standby Output Server to the transmission system. If the router operation is outside the control of iTX, the system needs a dummy router.

The job of the dummy router is to simulate the actions of a real router in response to the manual operation of router-control buttons on iTX Desktop layouts and so provide router status information to iTX.

Another type of iTX system that requires a dummy router is one that includes Ingest Manager (for automated ingest) without router-control functionality. The dummy router informs Ingest Manager that the recording source is connected directly to the Encode Server.

The iTX service called the Hardwired Router provides the dummy router. The service is contained in the following component of the Routers module:

- Hard Wired Router.

## Routing Data Service

The passing of routing information to and from the System Database is done by an iTX service called the Routing Data Service. This service receives information from router-control services. It sends this information to any client (e.g. one displaying an iTX Desktop layout with routing components) that requests it.

The Routing Data Service is contained in the Database Server module. It should be installed with the other services in this module.

## Installing a Router Bridge

Router control in some broadcasting systems may require Grass Valley applications called the Sharer and the System Manager to be running. To enable iTX to operate one or more matrix routers in such a system, you need to install the Router - Router Bridge component (from the Routers module). We recommend you install the component on the Database Server machine.

The component installs a router-control service, the Router Bridge. This presents itself as a single router, containing the crosspoints (i.e. sources and destinations) of all the routers under its control. It can make routes between sources and destinations that are on the same matrix router.

The Router Bridge can make routes between sources and destinations that are on different routers if the routers are connected by an available tie-line. This requires tie-line management software. For more information about the management of router tie-lines in an iTX system, contact iTX Support.

## Machine requirements for a Router Bridge

Ensure the machine on which you install the Router Bridge component meets these requirements:

- It has an IP address that is in the same subnet as the Sharer.
- It is registered as an engine in the System Manager with the following settings.  
Area: Default  
User rights: SYS  
Platform: Server  
Availability: All areas

For more information about the Sharer and System Manager, contact iTX Support.

## Install the Router Bridge

1. Double-click **Setup.exe** in the installation folder, iTX Suite, to start the installer.

The installer displays the iTX Installer dialog.

2. Click **Select Software** to open the Select Software to Install dialog.
3. Expand the Routing category and then the Routers sub-category.

Select the iTX Core Bridge Base, Server Base and Router -Router Bridge components; ensure the other components in the Routers module are not selected.

Click **OK** to close the Select Software to Install dialog.

The iTX Installer dialog shows the components that you selected.

4. Click **Continue**.

The installer performs the installation. In doing so, it starts the Core Bridge Base Setup wizard.

Respond to the prompts of the wizard to install the Core Bridge Base. Enter the required details when the wizard requests them:

- The IP address of the machine on which you are installing the Core Bridge Base.
- Connection details for the OmniBus Sharer. You need to enter the IP address of the machine on which the Sharer is running and the host name.

Once the Core Bridge Base is installed, the installer installs the other components. In doing so, it places a configuration file in a folder with the program executable. The default path of the folder is:

C:\Program Files (x86)\iTX 2.0\Services\RouterBridge

The program configuration file is called "RouterBridge.exe.config".

5. Click **Finish** to close the iTX Installer dialog.

## Running the Router Bridge

The Server Controller on the same machine automatically starts the Router Bridge. When the router-control service starts for the first time, it registers the details of the router in the System Database.

## Configuring an iTX system after the installation of a Router Bridge

Router device drivers keep details of sources and destinations on routers that are under their control. When the Router Bridge starts for the first time, it copies this information and holds it in its own memory. You need to use the Router Bridge to pass the information to the Routing Data Service, which then stores it in the System Database.

### Change the name of the Router Bridge

By default, the Router Bridge appears with the name "Router Bridge" in features on the iTX Desktop layouts. You can change the name by editing the program configuration file.

1. Open the configuration file, "RouterBridge.exe.config".
2. Enter a new name for the service by changing the value for the Matrix Name key in the appSettings section.

For example:

```
<appSettings>
...
<add key="Matrix Name" value="Main Router"/>
...
</appSettings>
```

3. Save the configuration file.



## Test the Router Bridge connection

When the Router Bridge starts for the first time, you should run the basic diagnostics test and check that this happens successfully.

1. In the Router Bridge window, select the Diagnostics tab.
2. Click **Run Passive Diagnostics Report**.

## Copy crosspoint details to the System Database from the Router Bridge

For this procedure, the Router Bridge and Routing Data Service must be running; the system routers must be operating under the control of their device drivers.

1. Select the Router Bridge window.
2. Select the Matrix tab and check that the router details appear in the Sources, Destinations and Levels lists.
3. Do the following to copy the router details to the System Database.
  - Click **Refresh the crosspoints Name and Alias from the G2 database**. The system displays a warning dialog.

When you are setting up the system for the first time, the warning has no relevance since the information it refers to is not yet in the System Database.
  - Click **Yes** to close the dialog and perform the operation.
4. Do the following to check the router details are in the System Database.
  - Select the Routing Data Service window.
  - Select the Matrix Details tab.
  - Select the Router Bridge in the **Matrix** box, and view the Sources, Destinations and Levels lists.

## Perform test routes from the Router Bridge

The Router Bridge can perform test routes by using router details from either its memory or from the System Database.

1. Select the Router Bridge window.
2. Select the Test tab.
3. In the CrossPoint Source section, select Local. This sets up the Router Bridge to use the router details it holds in its memory, with no reference to the System Database.
4. Do the following a number of times to perform some test routing.
  - From the **Destination** dropdown list, select a destination.
  - From the **Source** dropdown list, select a source that is on the same matrix router as the selected destination.
  - From the **Level** dropdown list, select a level.
  - Click **Route**. Check that the routing happens.

If the Router Bridge successfully performs the tests, the part of the system that consists of the device drivers and routers is working.

5. In the CrossPoint Source section, select **DataService**. This sets up the Router Bridge to use the full system in performing test routes.
6. Select destinations, sources and levels and perform some test routing. Ensure the source and destination you select for any test route are on the same matrix router.

If the Router Bridge successfully performs the tests, the connections between the Router Bridge, the Routing Data Service and the System Database are working. If a test route fails, there may be invalid data in the System Database.

## Updating information from the Router Bridge

Router details held by device drivers may change after the initial configuration of the system. For instance, crosspoint names may be changed; sources or destinations may be added or removed.

If this happens, the Router Bridge automatically updates the information in its memory. But you need to manually update the System Database. There are two ways in which you can do this:

- You can instantly copy all the crosspoint information from the Router Bridge; this overwrites the existing information for the relevant routers in the System Database.
- You can copy information for selected crosspoints from the Router Bridge; this overwrites just the existing information for those crosspoints in the System Database.

### Note:

- iTX Desktop layouts display the crosspoint names and aliases that are in the System Database. An alias is an alternative name for a crosspoint; it is usually more descriptive than the basic crosspoint name.
- You can use the Routing Configuration Tool to change crosspoint details in the System Database; this does not change information in the device drivers. [More details](#), page 323.
- Updating the crosspoint list in the System Database cancels any changes you make through the Routing Configuration Tool. The names and aliases that the iTX Desktop layouts then display are those that are held by the device drivers. You need to use the Routing Configuration Tool if you want to restore your changes.

## Copy all information from the Router Bridge to the System Database

For this procedure, you use a feature under the Conflict Resolution tab of the Router Bridge window.

1. Do the following to update the routing information in the System Database completely.
  - Select the Router Bridge window.
  - Select the Conflict Resolution tab.
  - Click **Refresh the crosspoints Name and Alias from the G2 database**.

The Routing Data Service refreshes the crosspoint list in the System Database; it overwrites existing information with information that the Router Bridge reads from the device drivers.

## Copy selected information from the Router Bridge to the System Database

For this procedure, you use the features under the Conflict Resolution tab of the Router Bridge window. Under the tab, there are two lists:

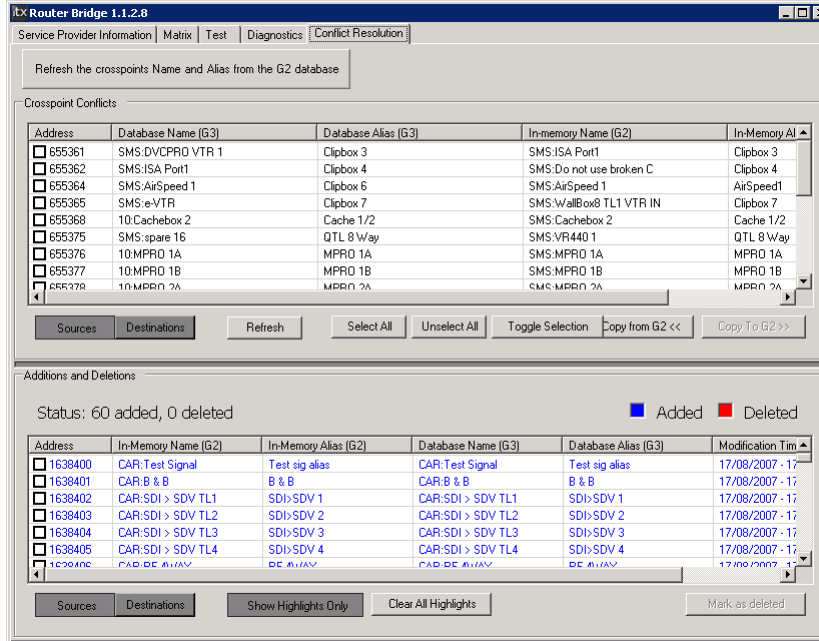

- The upper list shows crosspoint details in the System Database that are different from the corresponding crosspoint details in the Router Bridge memory. You can select crosspoints in the list and copy their details from the Router Bridge to the System Database.
- The lower list contains details of crosspoints that have been added to, or removed from, the Router Bridge memory but not the System Database. You need to delete non-existent crosspoints from the System Database to ensure operators do not try to use them.

For both lists, you view sources and destinations alternately.

1. Select the Router Bridge window.
2. Select the Conflict Resolution tab.
3. Working with the upper list, do the following for the crosspoints whose details you want to update in the System Database.
  - Click **Sources** or **Destinations** to display details of crosspoints of the selected type.
  - Select crosspoints in the list.
  - Click **Copy from G2**.

The Routing Data Service refreshes the selected crosspoint details in the System Database; it overwrites existing information with information that the Router Bridge reads from the device drivers.

4. Working with the lower list, do the following for crosspoints you want to delete from the System Database.
  - Click **Sources** or **Destinations** to display details of crosspoints of the selected type.
  - Select crosspoints in the list.
  - Click **Mark as deleted**.

The Routing Data Service deletes the crosspoints from the System Database; they become unavailable to use on iTX Desktop layouts.

## Installing a GVG Acappella Router Server

To enable iTX to operate a GVG Acappella router, you install the GVG Acappella Router component (from the Routers module). The GVG Acappella Router Server in this component can control one GVG Acappella router. We recommend you install the component on the Database Server machine.

### Install the GVG Acappella Router Server

1. Double-click **Setup.exe** in the installation folder, iTX Suite, to start the installer.  
The installer displays the iTX Installer dialog.
2. Click **Select Software** to open the Select Software to Install dialog.
3. Expand the Routing category and then the Routers sub-category.  
Select the GVG Acappella Router component; select the Server Base if you are installing the component on a machine that does not already have a Server Controller installed. Ensure the other components in the Routers module are not selected.  
Click **OK** to close the Select Software to Install dialog.
4. The iTX Installer dialog shows the components that you selected.
5. Click **Continue**.  
The installer performs the installation.
6. Click **Finish** to close the iTX Installer dialog.

### Running the Acappella Router Server

The Server Controller on the same machine automatically starts the GVG Acappella Router Server. When the router-control service starts for the first time, it registers the details of the router in the System Database.

## Configuring an iTX system after the installation of a GVG Acappella Router Server

You need to configure the router-control service to work with the GVG Acappella router. For this, you use the Acappella Router configuration panel.

You may need to add the panel to an iTX Desktop layout. You can do this while the layout is in the editing mode. The panel is in the Routing, Basic category of the iTX Desktop Toolbox.

In configuring the router-control service, you enter network-connection details of the GVG Acappella router that the service is to control.

These configuration instructions cover a single-level GVG Acappella router. If you have problems when configuring a multiple-level router, contact iTX Support.

## Add the Acappella Router configuration panel to a layout

1. Right-click the title bar or a clear area of the layout to display the iTX Desktop menu. Select **Edit** to put the layout in the editing mode.
2. In the Toolbox, expand the categories ROUTING and BASIC. Select **Configuration, GVG Acappella** and drag it to a clear area of the layout.  
The Acappella Router configuration panel appears on the layout.
3. If you want to save the layout with the configuration panel on it, right-click the title bar (or a clear area of the layout) to display the iTX Desktop menu; select **Save Layout**.
4. Return the layout to the normal operating mode.

## Enter network-connection details

1. In the **Router** box on the configuration panel, select the GVG Acappella Router Server.
2. Do the following to set the router connection details.
  - Enter the IP address of the router in the **IP Address** box.
  - Enter the port number in the **Port** box: this must be 12345.
  - In the **Check for Router** box, enter how often the GVG Acappella Router Server should check its connection to the router.

**Note:** Do not include leading zeroes in the IP address. For example, enter 1.51.51.151, not 001.051.051.151.
3. To modify the types of log messages the service generates, do the following.
  - Select the log message types (for example, **Log Errors**) you want the service to generate.
  - Ensure log message types (for example, **Log Warnings**) you do not want the service to generate are not selected.
4. Click **Update**.

## Enter crosspoint details in the System Database

1. Select the GVG Acappella Router Server window.
2. Select the Matrix tab.
3. Check the service displays lists of the sources and destinations that are on the GVG Acappella router.
4. On the Routing Configuration pop-up layout, use the Routing Configuration Tool to enter the crosspoint information. [More details](#), page 322.

## Perform test routes

On the Routing Configuration pop-up layout, use the Routing Configuration Tool to make test routes. [More details](#), page 323.

## Installing an NVision NV9000 Router Control System Service

To enable iTX to operate an NVision NV9000 router, you install the NVision NV9000 Router Service component (from the Routers module). The NVision NV9000 Router Control System Service in this component can control one NVision NV9000 router. We recommend you install the component on the Database Server machine.

### Install the NVision NV9000 Router Service

1. Double-click **Setup.exe** in the installation folder, iTX Suite, to start the installer.  
The installer displays the iTX Installer dialog.
2. Click **Select Software** to open the Select Software to Install dialog.
3. Expand the Routing category and then the Routers sub-category.  
Select the NVision NV9000 Router Service component; select the Server Base if you are installing the component on a machine that does not already have a Server Controller installed. Ensure the other components in the Routers module are not selected.  
Click **OK** to close the Select Software to Install dialog.
4. The iTX Installer dialog shows the components that you selected.
5. Click **Continue**.  
The installer performs the installation. In doing so, it places a configuration file in a folder with the program executable. The default path of the folder is:  
C:\Program Files (x86)\iTX 2.0\Services\NV9000RoutingService  
The program configuration file is called "G3NV9000RouterService.exe.config".
6. When the installer completes the installation, click **Finish** to close the iTX Installer dialog.

### Running the NVision NV9000 Router Service

The Server Controller on the same machine automatically starts the NVision NV9000 Router Control System Service. When the router-control service starts for the first time, it registers the details of the router in the System Database.

## Configuring an iTX system after the installation of an NVision NV9000 Router Control System Service

You need to configure the router-control service to work with the NVision NV9000 router. To do this, you enter network-connection details of the NVision NV9000 router that the service is to control.

### Enter the router connection details in the program configuration file

1. Open the configuration file, "G3NV9000RouterService.exe.config".
2. Enter the IP address and port of the NVision NV9000 router by changing the values for the "RouterIpAddress" and "RouterPort" keys in the appSettings section.

For example:

```
<appSettings>
...
<add key="RouterName" value="NV9000 Router Control System" />
<add key="RouterIpAddress" value="172.41.249.82" />
<add key="RouterPort" value="9193" />
...
</appSettings>
```

3. Save the configuration file.

## Enter router connection details in the NVision NV9000 Router Control System Service

1. Select the NVision NV9000 Router Control System Service window.
2. Select the Setup tab.
3. Do the following to set the router connection details.
  - Enter the name of the NVision NV9000 router in the **Name** box.
  - Enter the IP address in the **IP Address** box.
  - Enter the port number in the **Port** box.
  - In the **Diagnostic Source** box, enter the router source the service is to use for diagnostics tests.
  - In the **Diagnostic Destination** box, enter the router destination the service is to use for diagnostics tests.
  - In the **Check for Connection Rate** time entry box, enter how often the service should check its connection to the NVision NV9000 router.
4. To modify the types of log messages the router-control service generates, do the following.
  - Select the log message types (for example, **Log Errors**) you want the service to generate.
  - Ensure log message types (for example, **Log Warnings**) you do not want the service to generate are not selected.
5. Click **Save**.

## Enter crosspoint details in the System Database

1. Select the NVision NV9000 Router Control System Service window.
2. Select the Matrix tab.
3. Check the service displays lists of the sources and destinations that are on the NVision NV9000 router.
4. On the Routing Configuration pop-up layout, use the Routing Configuration Tool to enter the crosspoint information. [More details](#), page 322.

## Perform test routes

1. On the Routing Configuration pop-up layout, use the Routing Configuration Tool to make test routes. [More details](#), page 323.

## Reloading Configuration changes to the NV9000

Configuration changes made to the NV9000 router directly (such as the names of router sources and destinations) need to be reloaded by iTX. This is done via the “Refresh from Router” button on the NV9000 Router Service “Setup” tab.

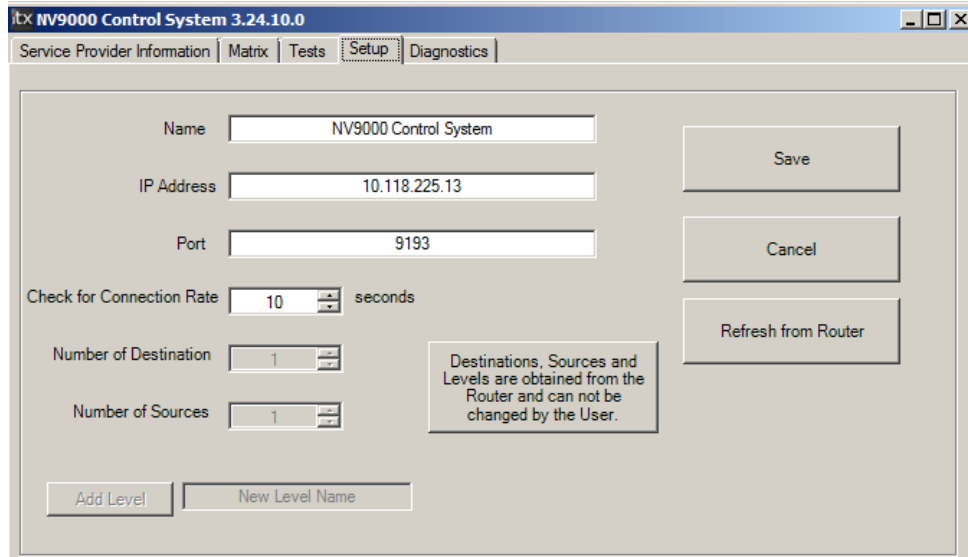

Clicking on the “Refresh from Router” button causes the NVision NV9000 Router Service to request from the NV9000 router details of its configuration and the status of the devices. The SQL Router Crosspoint table is then updated with this information.

This enables changes to NV9000 device names and the addition of new NV9000 devices made using the NV9000 configuration utility to be incorporated within the iTX database.

## Installing the Evertz 7700 Router Server

To enable iTX to operate an Evertz 7700 router, you install the Evertz7700 Router Service component (from the Routers module). The Evertz 7700 Router Server in this component can control one Evertz 7700 router. We recommend you install the component on the Database Server machine.

### Install the Evertz7700 Router Server

1. Double-click **Setup.exe** in the installation folder, iTX Suite, to start the installer.

The installer displays the iTX Installer dialog.

2. Click **Select Software** to open the Select Software to Install dialog.
3. Expand the Routing category and then the Routers sub-category.

Select the Evertz7700 Router Service component; select the Server Base if you are installing the component on a machine that does not already have a Server Controller installed. Ensure the other components in the Routers module are not selected.

Click **OK** to close the Select Software to Install dialog.

4. The iTX Installer dialog shows the components that you selected.



5. Click **Continue**.  
The installer performs the installation.
6. Click **Finish** to close the iTX Installer dialog.

## Running the Evertz7700 Router Server

The Server Controller on the same machine automatically starts the Evertz 7700 Router Server. When the router-control service starts for the first time, it registers the details of the router in the System Database.

## Configuring an iTX system after the installation of an Evertz 7700 Router Server

You need to configure the router-control service to work with the Evertz 7700 router. To do this, you add the Evertz 7700 Router configuration panel to a layout. In the panel, you enter network-connection details of the Evertz 7700 router that the service is to control.

### Add the Evertz 7700 Router configuration panel to a layout

1. Right-click the title bar or a clear area of the layout to display the iTX Desktop menu. Select **Edit** to put the layout in the editing mode.
2. In the Toolbox, expand the categories ROUTING and BASIC. Select **Configuration, Evertz 7700** and drag it to a clear area of the layout.

The Evertz 7700 Router configuration panel appears on the layout.

**Note:** If the Toolbox does not contain the Evertz 7700 Router configuration panel, you need to install the "Custom – AT\_T Desktop Components" module on the iTX Desktop Client workstation.

3. If you want to save the layout, right-click the title bar (or a clear area of the layout) to display the iTX Desktop menu; select **Save Layout**.
4. Return the layout to the normal operating mode.

### Enter connection details in the Evertz 7700 Router configuration panel

1. In the **Router** box on the configuration panel, select the Evertz 7700 router.
2. Do the following (in the Router Communication Settings area) to enter the router-connection details.
  - Enter the IP address of the router in the **IP Address** box.
  - Enter the port number in the **Port** box.
  - In the **Check For Router** box, enter how often the Evertz 7700 Router Server should check its connection to the router.
3. Do the following (in the Server Communication Settings area) to enter the connection details for the router-control service.

- Enter the IP address of the machine on which the Evertz 7700 Router Server is running in the **Primary IP Address** box.
- Enter the port number in the **Primary Port** box.
- If there is a back-up Evertz 7700 Router Server in your system, enter the IP address of the machine on which this is running in the **Backup IP Address** box; enter the port number in the **Backup Port** box.

iTX does not use the other settings in the Server Communication Settings area (**SNMP Read Community, SNMP Write Community, SNMP Version**).

4. To modify the types of log messages the router-control service generates, do the following.
  - Select the log message types (for example, **Log Errors**) you want the service to generate.
  - Ensure log message types (for example, **Log Warnings**) you do not want the service to generate are not selected.
5. Click **Update**.

## Enter crosspoint details in the System Database

1. Select the Evertz 7700 Router Server window.
2. Select the Matrix tab.
3. Check the service displays lists of the sources and destinations that are on the Evertz 7700 router.
4. On the Routing Configuration pop-up layout, use the Routing Configuration Tool to enter the crosspoint information. [More details](#), page 322.

## Perform test routes

On the Routing Configuration pop-up layout, use the Routing Configuration Tool to make test routes. [More details](#), page 323.

# Installing the Quartz Router Service

To enable iTX to operate an Evertz (Quartz) EQX router, you install the Quartz Router Service component (from the Routers module). The Quartz Router Service in this component can control one EQX router. We recommend you install the component on the Database Server machine.

## Install the Quartz Router Service

1. Double-click **Setup.exe** in the installation folder, iTX Suite, to start the installer.  
The installer displays the iTX Installer dialog.
2. Click **Select Software** to open the Select Software to Install dialog.
3. Expand the Routing category and then the Routers sub-category.

Select the Quartz Router Service component; select the Server Base if you are installing the component on a machine that does not already have a Server Controller installed. Ensure the other components in the Routers module are not selected.

Click **OK** to close the Select Software to Install dialog.

4. The iTX Installer dialog shows the components that you selected.
5. Click **Continue**.  
The installer performs the installation.
6. Click **Finish** to close the iTX Installer dialog.

## Running the Quartz Router Service

The Server Controller on the same machine automatically starts the Quartz Router Service. When the router-control service starts for the first time, it registers the details of the router in the System Database.

## Configuring an iTX system after the installation of a Quartz Router Service

You need to configure the router-control service to work with the Evertz (Quartz) EQX router. To do this, you add the Quartz Router configuration panel to a layout. In the panel, you enter network-connection details of the EQX router that the service is to control.

### Add the Quartz Router configuration panel to a layout

1. Right-click the title bar (or a clear area of the layout) to display the iTX Desktop menu. Select **Edit** to put the layout in the editing mode.
2. In the Toolbox, expand the categories ROUTING and BASIC. Select **Quartz Service Configuration** and drag it to a clear area of the layout.

The Quartz Router configuration panel appears on the layout.

**Note:** If the Toolbox does not contain the Quartz Router configuration panel, you need to install the "Custom – AT\_T Desktop Components" module on the iTX Desktop Client Workstation.

3. If you want to save the layout, right-click the title bar (or a clear area of the layout) to display the iTX Desktop menu; select **Save Layout**.
4. Return the layout to the normal operating mode.

### Enter connection details in the Quartz Router configuration panel

1. In the **Router** box on the configuration panel, select the EQX router.
2. Do the following to enter the router-connection details.
  - Enter the IP address of the router in the **IP Address** box.
  - Enter the port number in the **Port** box.

- In the **Check Connection Interval** box, enter how often (in seconds) the Quartz Router Service should check its connection to the router. You should not enter fewer than 30 seconds for this setting.

**Note:** Do not include leading zeroes in the IP address. For example, enter 1.51.51.151, not 001.051.051.151.

3. Click **Save**.

## Enter crosspoint details in the System Database

1. Select the Quartz Router Service window.
2. Select the Tests tab.
3. Do the following to change the size of the router matrix.
  - Enter the number of sources on the router in the **Sources** box.
  - Enter the number of destinations on the router in the **Destination** box.
  - Click **Change Matrix**.
4. For each router level, enter the level in the **Add Level** box and then click **Add Level**. Add the router levels in this order:
  - For a router with 8 levels: V, A, B, C, D, E, F, G.
  - For a router with 16 levels: V, A, B, C, D, E, F, G, H, I, J, K, L, M, N, O.
5. Select the Matrix tab.
6. Check the service displays lists of the sources and destinations that are on the EQX router.
7. On the Routing Configuration pop-up layout, use the Routing Configuration Tool to enter the crosspoint information. [More details](#), page 323.

## Perform test routes

On the Routing Configuration pop-up layout, use the Routing Configuration Tool to make test routes. [More details](#), page 323.

## Installing the Hardwired Router (for a dummy router)

During testing iTX may require routing-status information, even when it is not set up to operate a router; for instance, to work with Ingest Manager or after an Output Server failover. For such situations, you can install the Hard Wired Router component and set up a dummy router. We recommend you install the component on the Database Server machine.

### Warning:

- The Hardwired Router service is only designed to be used in temporary test setup. It is not intended to be used as a permanent routing solution.

## Install the Hard Wired Router

1. Double-click **Setup.exe** in the installation folder, iTX Suite, to start the installer.

The installer displays the iTX Installer dialog.

2. Click **Select Software** to open the Select Software to Install dialog.
3. Expand the Routing category and then the Routers sub-category.

Select the check box for the Hard Wired Router component; select the Server Base if you are installing the component on a machine that does not already have a Server Controller installed. Ensure the other components in the Routers module are not selected.

Click **OK** to close the Select Software to Install dialog.

4. The iTX Installer dialog shows the components that you selected.
5. Click **Continue**.

The installer performs the installation. In doing so, it places a configuration file in the folder with the program executable. The default path of the folder is:  
C:\Program Files (x86)\iTX 2.0\Services\ITX Hardwired Router

The program configuration file is called "defaultconfig.txt". To set up the dummy router for use with back-up Output Servers, you enter crosspoint details in this file.

6. When the installer completes the installation, click **Finish** to close the iTX Installer dialog.

## Running the Hard Wired Router

The Server Controller on the same machine automatically starts the Hardwired Router. When the Hardwired Router starts for the first time, it registers the details of the router in the System Database.

## Configuring an iTX system after the installation of a Hardwired Router

### Warning:

- The Hardwired Router service is only designed to be used in temporary test setup. As such the configuration is not preserved on restart of the service.

### Stop the router-control service

Before you enter the crosspoint details for the dummy router, you should stop the Hardwired Router.

1. Select the Controlled Services information tab in the Server Controller window.
2. Right-click the **Hardwired Matrix** entry in the controlled services list; click **Stop Service** from the displayed menu.

The Server Controller stops the router-control service.

## Enter crosspoint details for the dummy router in the program configuration file

To set up the dummy router to simulate the actions of a real router when there is a failover of an Output Server, you need to specify sources and destinations for the master and slave channels that are running on the Output Servers.

This configuration is not necessary if you are only using the dummy router for Ingest Manager.

1. Open the configuration file, "defaultconfig.txt".

The configuration file lists sources and destinations on the dummy router. The entries in the file are comma-separated and have the following format.

For a source:

```
s,name,alias,router address
```

For a destination:

```
d,name,alias,router address
```

2. Edit the configuration file so that it includes the entries for your Output Server channels. See below, "[Example of a dummy-router configuration file](#)", page 320.
3. Save the configuration file.

### Note:

- When you start the Hardwired Router for the first time, the information in the configuration file "defaultconfig.txt" is copied into another file, "config.txt". If you upgrade the Hardwired Router, the installer does not overwrite the "config.txt" program configuration file.

## Example of a dummy-router configuration file

A configuration file for an iTX system with two playout channels, "iTX1" and "iTX2", and their back-up channels, may contain these entries:

```
s,Hardwired,,0
s,iTX1,,1
s,iTX1-Backup,,2
s,iTX2,,3
s,iTX2-Backup,,4

d,Hardwired,,0
d,iTX1,,1
d,iTX2,,2
```

Note that the address value increases for each source: no two sources can have the same address. The same rule applies to the destinations.

The selection buttons for sources and destinations on iTX Desktop layouts show the channel names in this example. If you include an alias in any source or destination entry, the corresponding selection button shows the alias instead.

## Restart the router-control service

1. Select the Controlled Services Information tab in the Server Controller window.
2. Right-click the **Hardwired Matrix** entry in the controlled services list; click **Start Service** from the displayed menu.

The Server Controller starts the router-control service.

## Enter crosspoint details in the System Database

1. Select the Hardwired Router window.
2. Select the Matrix tab.
3. Check the service displays lists of the sources and destinations that are on the Hardwired Router.
4. On the Routing Configuration pop-up layout, use the Routing Configuration Tool to enter the crosspoint information. [More details](#), page 322.

## Perform test routes

1. On the Routing Configuration pop-up layout, use the Routing Configuration Tool to make test routes. [More details](#), page 323.

## The Routing Configuration pop-up layout

To enter crosspoint details and make test routes, you use the Routing Configuration pop-up layout:

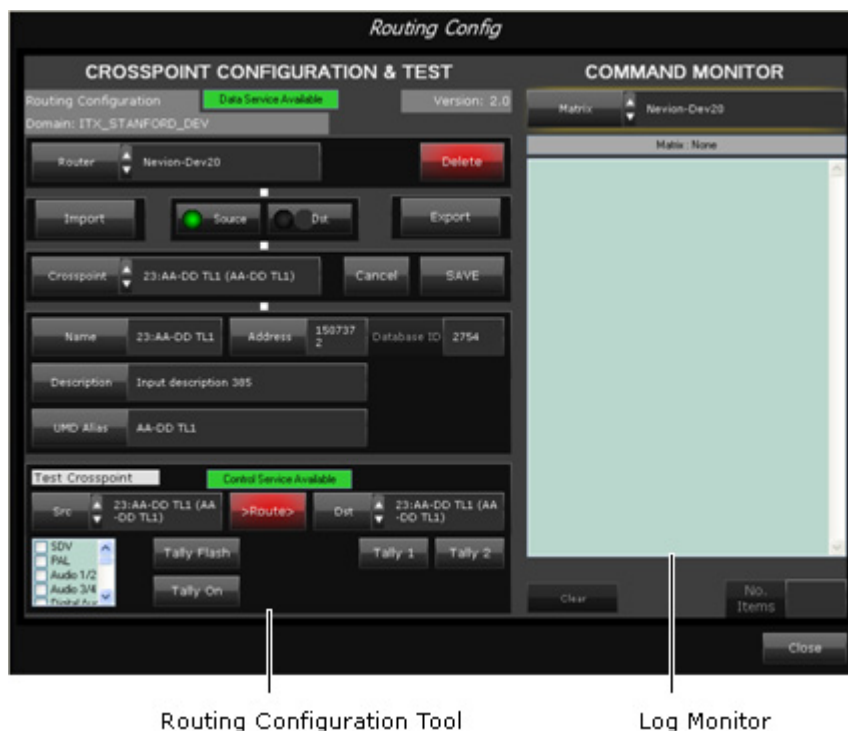

The layout, which you display from the Engineering layout, has two main components:

- A Routing Configuration Tool, for setting or viewing crosspoint information for a selected router.
- A Log Monitor, which displays details of the most recent routing operations performed by a specified router-control service.

## Routing Configuration Tool

Where the device driver for a router is a Grass Valley router-control application or a GVG Encore control system, you configure the device driver for the router. You then use the Router Bridge to copy the configuration information to the System Database. You can view and change this information in the Routing Configuration Tool.

For other types of routing system (ones that use an Acappella, NV9000, Evertz 7700 or Quartz router), you use the Routing Configuration Tool to manually enter the configuration information in the System Database. The router-control service receives crosspoint details, including the names of sources and destinations, from the router device driver.

Usually, the crosspoints are named according to a simple scheme (e.g. Src 1, Src 2, Src 3, etc. for sources). You can change the names and assign aliases to the router crosspoints. Aliases are alternative names that are more informative about the type of content passing through a source or destination.

The Routing Configuration Tool includes a Test Crosspoint panel. By using the features in this panel, you can operate the router to make routes between selected sources and destinations.

## Log Monitor

The Log Monitor receives and displays logs from a router-control service, which you select in the **Matrix** box.

## Display the Routing Configuration pop-up layout

1. Select the Engineering layout.
2. Click **Routing Config** in the System Management panel.

The Routing Configuration pop-up layout appears in front of the Engineering layout.

## Use the Routing Configuration Tool to enter crosspoint details in the System Database

By performing the following procedure, you can manually enter crosspoint details in the System Database.

1. Select a router in the **Router** box.
2. Select **Source** or **Dst**, depending on whether you want to work with sources or destinations.
3. Do the following for each crosspoint you want to set.

- Select a crosspoint in the **Crosspoint** box. A crosspoint is identified by a combination of its name and UMD alias.

The Routing Configuration Tool displays the information stored in the System Database for the selected crosspoint.

- Check the crosspoint name in the **Name** box.
- Check the address in the **Address** box. This is the router address that defines the crosspoint. This number must be unique for each crosspoint.



- Enter any comment you want to in the **Description** box. The comment appears in tool tips that give information about the crosspoint.
- Enter an alias in the **UMD Alias** box.
- Click **Save**.

## Use the Routing Configuration Tool to perform test routes

1. Select a router in the **Router** box.
2. In the Test Crosspoint panel, do the following for each test route you want to make.
  - Select a source in the **Src** box.
  - In the **Dst** box, select a destination that is on the same router as the selected source.
  - Select levels in the levels list.
3. Click **Route**. Check that the routing happens.

## Viewing details of a router event in the Log Monitor

In the Log Monitor, a grey entry indicates a request to the router-control service to make a route; a black entry indicates the response from the service.

Double-clicking an entry causes iTX to display a dialog containing full details of a routing event.

The destination status list displays routed levels to selected destinations.

## Filtering by groups in routing configuration

It is possible to create categories for router sources and destinations via the Routing Data Service and then use those categories to filter by in routing desktop components on the iTX Desktop. This means the user does not have to scroll through the entire list of sources or destinations, but can select a category to make the selection process easier.

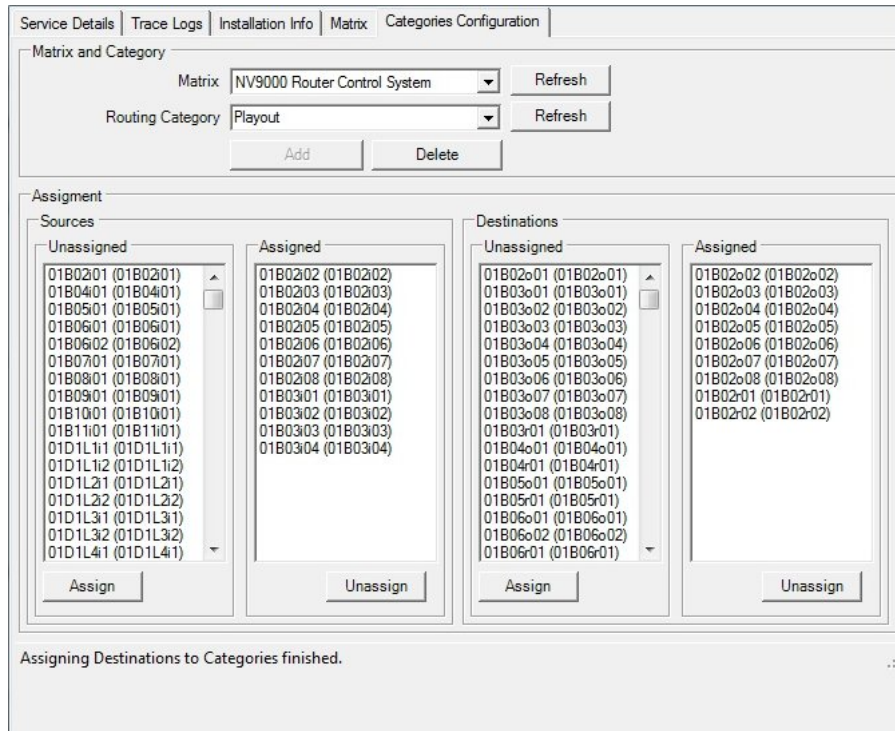

Service Details | Trace Logs | Installation Info | **Matrix** | Categories Configuration

Matrix and Category

Matrix: NV9000 Router Control System Refresh

Routing Category: Playout Refresh

Add Delete

Assignment

Sources

Unassigned

Assigned

Destinations

Unassigned

Assigned

Assigning Destinations to Categories finished.

The user can create and delete categories, or select existing ones and add or remove sources and destinations. They can be block or multi-selected for eas of assignment.

The iTX Routing Desktop routing components can then be configured to run in categories mode if required. This has to be done by a user with administrative rights.

Any component that allows the user to select a source or destination can now be made to show categories by right clicking and selecting Properties from the options menu when in edit mode. Selecting Route List Configuration will bring up the Categories on/off toggle dialog.

Once active, any source or destination selection dialog will allow the user to select a category first and then the router source or destination from the filtered list.

## Setting up router control on the Router Control layout

Routing systems vary greatly from one television station or playout centre to another.

Because of this, it is not possible for one iTX Desktop layout to satisfy the router-control requirements of all systems. Instead, during the installation of an iTX system, a Grass Valley engineer may design and configure an iTX Desktop layout from which you can control a router.

Among iTX Desktop layouts that are intended for system-administration, we provide a sample Router Control layout. This layout contains:

- A dynamic layout containing a Destination Button Panel.
- A dynamic layout containing a Source Button Panel.
- To the left of each dynamic layout, a Layout Selector with selection buttons mapped to available dynamic layouts.
- A Destination Monitor and Destination Lock button.

Sample dynamic layouts with Source and Destination Button Panels are provided in the Routing folder in the Popups folder.

## Configuring the Router Control layout

In configuring the Router Control layout, you need to separately configure all dynamic layouts that are to be available from the main layout. You can do this when the dynamic layouts are loaded into your system-administrator user view.

We recommend you configure copies of the sample layouts (rather than work with the originals). This prevents you losing your modifications when layouts are replaced during a system upgrade. You should copy the Router Control layout and the dynamic layouts to your user view, rename them, modify them and save them as global layouts.

The Source and Destination Button Panels have a default number of source and destination selection buttons. You need to map these buttons to the sources and destinations on the router you want to control; in doing so, you can change the number of buttons in the panels.

We describe how to configure the button panels earlier in this manual. See: “Map destination buttons to router destinations”, page 124; and “Map source buttons to router sources”, page 125.

On the Router Control layout, you assign dynamic layouts to the Layout Selectors.

The Destination Lock Button requires no configuration.

You can change the default titles of the button panels on the dynamic layouts to match the names of your routers. You do this through the Group Properties dialog. [More details](#), page 122.

### Note:

- When mapping buttons to crosspoints that are controlled by the Router Bridge, ensure all the routes that can be selected are valid.

## Using the features on the Router Control layout

On the Router Control layout, you can:

- Select any available dynamic layout displaying a Source Button Panel or a Destination Button Panel.
- Use the buttons on the displayed Source and Destination Button Panels to make a route between any available source and destination.

### Route a source to a destination from a router control panel

You use the buttons on a Source and Destination Button Panel to make a route between a source and a destination.

1. Click a destination button to select the associated router destination.

The button displays a green light to show that it is selected.

2. Click a source button.

iTX instantly makes the route: it uses the router service to connect the signals on the selected levels between the source and destination.

By default, the source button displays a green light. It may display a red light if its source is connected to an on-air destination; or a blue light, if its source is connected to an on-air destination and the button for that destination is also selected.

3. If you want to prevent any other user changing the route to a particular destination, do the following.
  - Ensure the destination is selected on the Destination Monitor.
  - Click **Lock** to lock the route.

iTX locks the route. The **Lock** button displays a green light. You can release the lock by clicking **Lock** again.

## Using iTX with a GPI device

An iTX system may use GPI (General Purpose Interface) devices for two types of process:

- iTX responds to GPI inputs generated by an external control panel. A GPI input triggers an action, such as "take next", in the layout of schedule events.
- iTX generates GPI outputs to control broadcasting equipment; for example, an aspect ratio converter. It does this when GPI output events are included in a schedule.

### Supported GPI devices

iTX supports the specified GPI devices from the following manufacturers:

#### DNF Controls

USP-8; USP-8A; USP-EM-8; USP-SNMP-8; USP-16; USP-EM-16; USP-SNMP-16

#### Videoframe

VNode 8x8; VNode 16x16; VNode 32x32

#### OmniBus

Timecode Card GPI Device

## The GPI Service

iTX can work with multiple GPI devices through a single service, called the GPI Service. This service performs two roles:

- As a separate device driver for each GPI device, it sends commands to operate a device or passes input signals from a device to iTX.
- As a data service, it transfers GPI data to and from the System Database; it sends this information to any client (e.g. one displaying an iTX Desktop layout) that requests it.

When working with multiple GPI devices they can be configured to work independently, as master/slave or as mirrored pairs.

To make the GPI Service available, you install the GPI Devices module. We recommend you install the module on the Database Server machine.

## Installing the GPI Devices module

1. Double-click **Setup.exe** in the installation folder, iTX Suite, to start the installer.

The installer displays the iTX Installer dialog.

2. Click **Select Software** to open the Select Software to Install dialog.
3. Expand the Database Server category and select **GPI Devices**.

Click **OK** to close the dialog.

The iTX Installer dialog shows the components in the selected module.

4. Click **Continue**.  
The installer performs the installation.
5. Click **Finish** to close the iTX Installer dialog.  
The Server Controller on the same machine automatically starts the GPI Service.

## Configuring the GPI Service

You need to configure the GPI Service to work with the GPI devices in your iTX system. To do this, you use the GPI Service Configuration application:

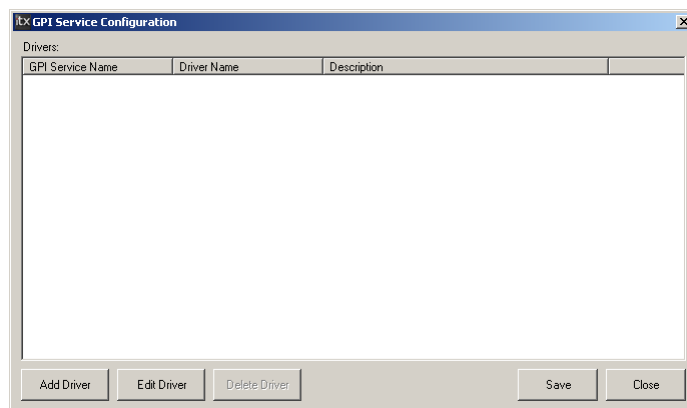

The application is installed with the GPI Devices module.

In configuring the GPI Service, you:

- Add a driver to the GPI Service for each GPI device the service is to control; each driver acts as a separate service, with a unique name, within the GPI Service.
- Enter the settings for each driver; these include the network-connection details of the associated GPI device.
- Assign names to the various input and output triggers for each GPI device.

### Start the GPI Service Configuration application

1. On the machine on which you install the GPI Devices module, select **GPI Service Config** from the Windows Start menu.  
The GPI Service Configuration window opens.

### Add a driver for a GPI device

You need to add a device driver for each GPI device that the service is to control.

1. Click **Add Driver**.  
The Driver Configuration dialog opens. This has a Device Configuration panel for displaying a batch of settings relevant to a specific type of GPI device; the panel is blank when no device type is selected.
2. In the **GPI Service Name** box, enter a name to identify the driver within the GPI Service; for example, VNode1. The name must be unique for each driver.

3. Click **Select**.

The Select Driver dialog opens and displays a list of available device drivers.

4. Select a driver. Click **OK** to close the Select Driver dialog and return to the Driver Configuration dialog.

The driver name appears in the **GPI Device Driver** box. The Device Configuration panel displays the settings for the driver.

5. Do the following to enter network-connection details.

- Enter the network address of the GPI device that the driver is to control in the **IP Address** box.
- Enter the number of the port on which the driver is to communicate with the GPI device in the **Port** box.

**Note:** Do not include leading zeroes in the IP address. For example, enter 1.51.51.151, not 001.051.051.151.

6. Check the other settings in the Device Configuration panel and modify these as necessary. In many cases, there is no need to change the default entries.

See below, "Configuration settings for a GPI Service driver".

7. Click **OK** to close the Driver Configuration dialog.

The GPI Service Configuration window displays the driver details:

- The service name of the driver.
- The driver type.
- A description of the driver type.

The driver is disabled after you add it. You need to enable it before iTX can use it to work with a GPI device. [More details](#), page 330.

The **Save** button flashes green.

8. Click **Save** to save the driver and its configuration details.

## Configuration settings for a GPI Service driver

Below is a list of the settings that may appear in the Device Configuration panel of the Driver Configuration dialog, depending on the type of driver you select.

We recommend you do not change the default value except where we tell you to do so.

Setting	Description
<i>General</i>	
(Primary/USP) IP Address	The network address of the GPI device.
(Primary/USP) Port	The port number for communications between the GPI Service and the GPI device. Example: for a Videoframe VNode, this is usually 5050.
<i>USP device</i>	

Setting	Description
Local Bind Address	The network address of the machine running the GPI Service.
Comms Check Rate	The interval, in milliseconds, that determines how often the GPI Service checks its connection with the GPI device.
<i>SNMP-enabled device</i>	
SNMP Version	The SNMP version (1, 2 or 3) the GPI device uses.
Max SNMP Retries	The number of times the GPI device retries to send an unsuccessful SNMP message.
Snmp Read Community	The SNMP read community name (equivalent to a password).
Snmp Write Community	The SNMP write community name (equivalent to a password).
Snmp Timeout	How long, in milliseconds, the GPI device waits for a response from a third-party system before closing the connection.
Redundant Hardware (Not Shared)	Select this option in a system where a primary GPI Service controls a main GPI device, and a back-up GPI Service controls a back-up GPI device.
<i>Videoframe VNode</i>	
Backup/Mirror Matrix to second VNode	Enable the GPI Service to work with a mirror or backup VNode.
Mirrored IP Address	The network address of the mirror VNode.
Mirrored Port	The port number for communications between the GPI Service and the mirror VNode.
Outputs:	Check <b>Mirror</b> to send outputs to both VNodes. Check <b>Master/Slave</b> to use the second VNode as a backup for the first for outputs. Alternatively, uncheck both boxes.
Inputs:	Check <b>Master/Slave</b> to use the second VNode as a backup for the first for inputs.

## Enable a GPI Service driver

You need to enable a driver before iTX can use it to work with a GPI device.

1. Right-click the service name of a driver in the GPI Service Configuration window; select **Enable GPI Device** from the displayed menu.
2. Click **Save**.

The driver is enabled.

### Note:



- You can disable a GPI Service driver by right-clicking its service name and selecting **Disable GPI Device**.

## Edit the settings for a GPI Service driver

You can edit the configuration settings for a driver.

1. Select a driver by clicking its service name in the GPI Service Configuration window; click **Edit Driver**.  
Or, right-click the service name and select **Edit GPI Device Config** from the displayed menu.  
The Driver Configuration dialog opens.
2. Change the device-configuration settings that you want to. (You cannot change the service name.) Click **OK** to close the Driver Configuration dialog.  
The **Save** button flashes green.
3. Click **Save** to save the new configuration.

## Delete a GPI Service driver

1. Select a driver by clicking its service name in the GPI Service Configuration window; click **Delete Driver**.  
Or, right-click the service name and select **Delete GPI Device** from the displayed menu.  
The GPI Configuration dialog opens, prompting you to confirm you want to delete the device driver.
2. Click **Yes**.  
The **Save** button flashes green.
3. Click **Save**.  
The driver is deleted.

## Restart the GPI Service

After adding, deleting or modifying the settings for a driver, you need to update the GPI Service by restarting it.

1. Close the window of the GPI Service to stop the service.  
The Server Controller restarts the service.  
For each enabled driver, a tab appears at the bottom of the user interface under the Service Provider Information tab. Selecting a driver tab displays information about the driver.

## Assign names to GPI input and output triggers

To assign names to the inputs and outputs of a GPI device, sometimes called a GPI matrix, you use the features under the GPI Matrix Setup tab of the GPI Service user interface.

1. Do the following to select a GPI matrix.
  - Click **Refresh Matrices** to refresh the list of available GPI devices.

- Select the service name of the driver for a GPI matrix in the **Select Matrix** box.
2. Do the following to configure GPI inputs.
  - Select a GPI input in the Inputs list.
  - In the Input or Output Details section, enter a name in the **Name** box.
  - Click **Save Matrix**.
  - Check that the name appears in the Inputs list.
3. Do the following to configure GPI outputs.
  - Select a GPI output in the Outputs list.
  - In the Input or Output Details section, enter a name in the **Name** box.
  - Click **Save Matrix**.
  - Check that the name appears in the Outputs list.
4. Restart the GPI Service. [More details](#), page 331.

**Note:**

- You can remove the assigned GPI input and output names from a GPI matrix by clicking **Delete Matrix**. After you restart the GPI Service, the input and output names return to their original state.

## Check inputs and outputs under the driver Status tab

For each driver, the GPI Service user interface displays a Status tab under which it gives details of GPI inputs and outputs that the driver can fire.

1. In the GPI Service user interface, select the Service Provider Information tab.
2. Select a driver tab (at the bottom) and then the Status tab.
3. Check that the names you configure under the GPI Matrix Setup tab appear in the boxes that represent the inputs and outputs.

**Note:**

- You can fire a test GPI from an iTX Desktop layout and check that the associated box under the Status tab is highlighted green.

## Assigning GPI inputs to playout actions

iTX responds to GPI inputs by performing certain playout actions ("take next", "skip next", etc.). The action triggered by a particular GPI input depends on the settings you make in the GPI Configuration panel on the Channel Plugin Configuration Tool. [More details](#), page 175.

## Setting up a Videoframe VNode

A Videoframe VNode is supplied pre-configured with network-connection parameters (IP address and netmask). When installing such a device in an iTX system, you need to change the IP address to one that is available in the system.

To do this, you use the Videoframe Configuration Application.

You run the application on a machine that is connected to the VNode through an Ethernet connection; the machine must have an IP address that is on the same subnet as the VNode.

The configuration application requires you to enter the current IP address of the VNode. If you do not know this, you may reset it to a "failsafe" setting (192.168.1.75) by operating a DIP switch on the VNode.

Instructions for changing the IP address are given in a Videoframe document supplied with the configuration application.

Once you have set the IP address on the VNode, you can configure the GPI Service driver that is to control the device. For this, you specify:

- The new IP address of the VNode.
- The communications port. You should set this to 5050.

See earlier in this section, "".

# Using Missing Materials Manager

## About Missing Materials Manager

Missing Materials Manager is an optional iTX service for helping to ensure content is on an iTX Media Store when it is needed for playout. It may use one or more Media Watchers to perform media management tasks that the Media Watchers by themselves do not perform. It has two main roles:

- For live schedules running in playout channels and stored schedules due to start in the near future (usually the next few days), it helps operators to manually ingest media that has not been ingested.
- For stored schedules that are due to start in the near future, it uses one or more Media Watchers to copy archived media files to Media Stores; there, the files are available for playout. Doing this before the schedules are loaded in playout channels reduces the workload on Media Watchers close to playout time.

In general, a media file is missing from the iTX system if it is not on a Media Store from which it can be directly transferred to an Output Server. It may be missing for one of three reasons:

- The media file is registered in the iTX system, but the media has not been ingested.
- The media file is registered in the iTX system, but the media is on an archive (e.g. DIVArchive).
- The media file is not registered in the iTX system.

Missing Materials Manager checks the stored back-up copies of schedules that are running in all, or just selected, playout channels (iTX routinely updates the back-up schedules as the live schedules change). It also checks specified schedules that are stored in the System Database but are not yet loaded in any playout channel. It uses selected Media Watchers to find out whether or not media files required by these schedules are on accessible Media Stores.

From these checks, Missing Materials Manager makes a list of events requiring media files that are missing. It processes the list in a special channel, the Missing Materials channel. By connecting a Schedule Grid on a layout to this channel, you can view the missing-materials list.

Action may be taken to make missing material available:

- An operator can control the manual ingest of registered media files by using an ingest layout.
- Unregistered media files may be manually ingested (and registered in the process) in the normal way, through a Media Store Inbox.
- Where required media files are on an archive, Missing Materials Manager automatically restores them: it requests the Media Watcher that has access to the archive to copy the files to a specified Media Store.

Missing Materials Manager can clear disk space on Media Stores by deleting media files that are no longer needed. It does this according to rules you set in configuring it.

## Reports

Missing Materials Manager can produce XML reports of missing media files. You can configure the service to do this at regular intervals or you can request it to produce an instant report at any time.

## Running multiple instances of Missing Materials Manager

Depending on its configuration, Missing Materials Manager may monitor all channels in an iTX system for missing media or just selected ones.

If you set up the service to operate for just a selected group of channels, you may set up other instances of the service for other groups of channels; each service manages its own Missing Materials channel. All instances may run on the same machine; you configure them independently.

An example of when you might use multiple instances of Missing Materials Manager is when you have a multi-channel iTX system with different Media Watchers and Media Stores allocated to different groups of channels.

### Important:

- When running multiple instances of Missing Materials Manager, you need to ensure each one is correctly configured for a specific Media Watcher and a group of playout channels. Only one service should have access to the media files on any particular Media Store.

## License dongle

To run Missing Materials Manager, the machine on which it is installed must have a hardware License key, or "dongle", inserted in one of its USB slots. This authenticates the iTX software and allows you to use the software once the License is registered in the iTX system.

In a system with multiple instances of Missing Materials Manager, the dongle must include a separate License for each instance.

## Installing the Missing Material Service module

You may install Missing Materials Manager on any server in your iTX system.

4. Double-click **Setup.exe** in the installation folder, iTX Suite, to start the installer.

The installer displays the iTX Installer dialog.

5. Click **Select Software** to open the Select Software to Install dialog.
6. Select the Missing Material Server module from the Content Manager category.  
Click **OK** to close the Select Software to Install dialog.

7. The iTX Installer dialog shows the components in the selected module.

8. Click **Continue**.

The installer performs the installation.

9. Click **Finish** to close the iTX Installer dialog.

- For any additional service instance you want to run on the same machine, add an entry to the list of controlled services in the Server Controller Configuration Tool. Give the instance a unique name (by using the `-n` argument).

For more information on how to install and run multiple instances of an iTX service, contact iTX Support.

- Place a License file for each service instance in the Inbox folder that is monitored by the Media Watcher; check that the Media Watcher processes the License file.

## Configuring Missing Materials Manager

Starting the Server Controller on the same machine automatically starts each instance of Missing Materials Manager.

To configure the service, you use the features under the Engineering tab of the Missing Materials Manager user interface:

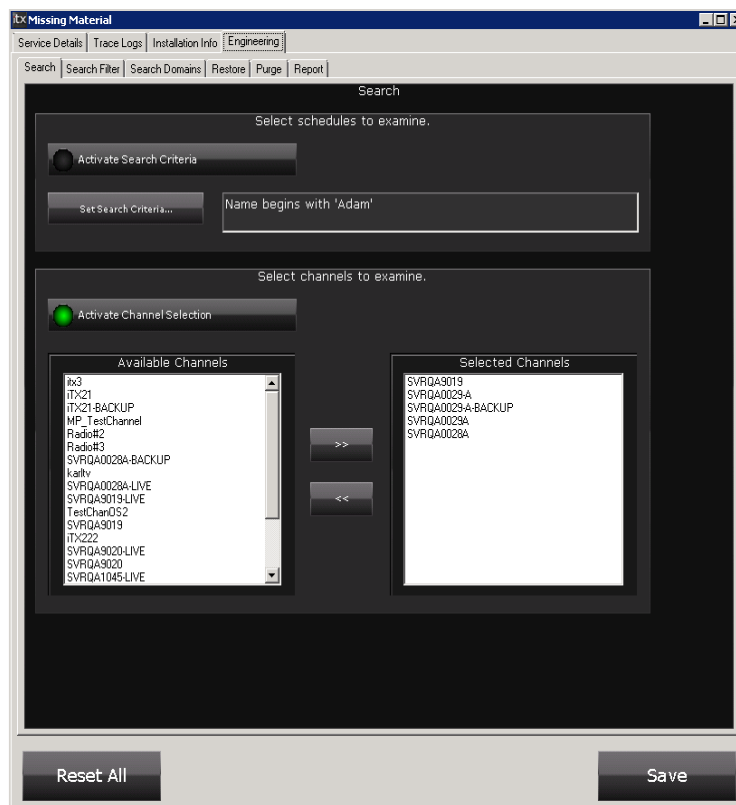

The Engineering tab is divided into four categories, identified by the General, Filtering, Channels and Reporting sub-tabs.

Under the General tab, you set up Missing Materials Manager to:

Activate Auto-Purge and set the type of purge you wish to take place.

Set the Auto-Purge Criteria.

Toggle the option to Purge Video Only

Manually Purge an asset using the purge request dialog.

- Control the usage of disk space on the Media Stores that it has access to.

- Work with specified Media Watchers.
- Select schedules that are stored in the System Database and search them for events with missing media files.

Under the Filtering tab, you:

- Specify the types of media file (video clip, logo, etc.) that Missing Materials Manager is to work with.
- Set the lengths of the active periods for two Missing Materials Manager processes: look ahead and cache ahead.

Under the Channels tab, you:

- Set up Missing Materials Manager to check schedules in all channels in an iTX system or just channels you select.

Under the Reporting tab, you:

- Set up Missing Materials Manager to produce reports (xml files) of missing media files.

## Saving your settings

After you change any settings, you need to click **Save** and restart the service for them to take effect.

## Automatic deletion of media files to clear disk space

By using the Media Watchers it is configured to work with, Missing Materials Manager can manage the usage of disk space on the Media Stores that are controlled by these Media Watchers.

When it does this, it aims to keep the amount of used space on each Media Store between two levels: an upper level called a "high water mark"; and a lower level called a "low water mark". It starts deleting unwanted files to make room for new ones when the store is filled to the high water mark; it stops deleting files when disk usage falls to the low water mark. We call the process auto-purging.

In selecting what files to delete, Missing Materials Manager reads a PinPoint results list; the list contains files that meet deletion criteria that you specify. Missing Materials Manager does not delete any media files for events that fall within its look-ahead time (see later in this section, "Look-ahead time") or any unfinished events in schedules running in playout channels.

When Missing Materials Manager deletes a media file from a Media Store, it may also delete the file record from the database. Whether it does so or not depends on a configuration option you select and may affect copies of the same media file on other Media Stores:

- If you select the **Purge Media only** option, Missing Materials Manager does not delete the file record; copies of the media file on other Media Stores are not deleted.
- If you select the **Purge clip (and media)** option, Missing Materials Manager deletes the file record; as a result, all copies of the media file on other Media Stores are also deleted. You should not select this option if you are running multiple instances of Media Manager; otherwise the service might delete media that other playout channels require.

You configure Missing Materials Manager to manage disk usage in the Auto-Purge Settings panel, which appears under the Engineering, General tab.

You use the panel features to:

- Switch auto-purging on or off.
- Specify whether or not Missing Materials Manager should delete the file record when it deletes a media file.
- Specify the criteria that identifies which media files Missing Materials Manager may select for deletion. You should ensure that the criteria you specify does not allow Missing Materials Manager to delete media files you want to keep.
- Set values – percentages of total disk space – for high and low water marks.

**Note:**

- After the installation of Missing Materials Manager, an activation file is needed to make auto-purging available. The requirement is to prevent the accidental deletion of media due to incorrect configuration of the service.

For information on how to activate auto-purging, contact iTX Support.

### **Set up Missing Materials Manager to automatically delete unwanted media files from a Media Store**

After installing the activation file to make auto-purging available, you need to do the following to set up Missing Materials Manager to use this functionality.

1. In the Missing Materials Manager window, select the Engineering, General tab.
2. In the box to the right of the **Activate Auto-Purge** button, select one of the options to control the way in which Missing Materials Manager deletes media files:
  - **Purge Clip (and media).**
  - **Purge Media only.** Ensure you select this option if you are configuring one of a number of instances of Missing Materials Manager.
3. Do the following to set up PinPoint to search for files.
  - Click **Set Purge Criteria** to open the PinPoint dialog.
  - Specify the criteria that identifies media files that are not required in the near future.
  - Click **OK** to close the PinPoint dialog.

**Note:** Even if a media file meets the specified criteria, Missing Materials Manager does not delete it if an event that falls within the look-ahead time needs it.
4. Position the **High water mark** and **Low water mark** sliders to set the points that control when Missing Materials Manager starts and stops deleting files.

**Note:** You should set a low water mark that is about 10 to 20% below the high water mark. This results in frequent low-volume purges.
5. Select **Activate Auto-Purge**.

### **Prevent Missing Materials Manager automatically deleting media files**

You should switch off auto-purging if you do not want Missing Materials Manager to delete files.



1. On the Auto-Purge Settings panel, cancel the **Activate Auto-Purge** selection.

## Selecting Media Watchers for Missing Materials Manager to work with

The Media Sources list under the Engineering, General tab shows the names of the Media Watchers that Missing Materials Manager may use in checking the availability of media files.

You can modify this list by adding or removing Media Watchers.

### Add a Media Watcher to the Media Sources list

1. In the Missing Materials Manager window, select the Engineering, General tab.
2. On the Media Sources panel, click **Add**.  
Missing Materials Manager displays the Select Connection For Missing Materials To Manage dialog.
3. Select a Media Watcher in the **Media Watcher** box. You may use the trim buttons to scroll through a list of Media Watchers; or you may click **Media Watcher** and select from a displayed list.  
You may need to click **Refresh List** to see all available Media Watchers.
4. Click **Add**.  
Missing Materials Manager adds the Media Watcher to the Media Sources list and closes the dialog.

### Remove a Media Watcher from the Media Sources list

1. Select a Media Watcher in the Media Sources list.
2. Click **Remove**.  
Missing Materials Manager removes the Media Watcher from the Media Sources list.

### Check that Missing Materials Manager can connect to a Media Watcher

1. Select a Media Watcher in the Media Sources list.
2. Click **Recheck Status**.  
An "Available" entry in the Status column indicates Missing Materials Manager can connect to the Media Watcher.

## Searching stored schedules for events with missing media files

One of the main purposes of Missing Materials Manager is to ensure media files are on Media Stores before schedules that require them are loaded in playout channels.

You set it up for this by using the features in the bottom panel under the Engineering, General tab.

- By selecting the **Activate Search Criteria** option, you instruct Missing Materials Manager to search stored schedules for events with missing media files. (The events must have playout dates.)

- From the **Set Search Criteria** button, you display PinPoint; you then specify the criteria that causes PinPoint to return a list of the schedules that you want Missing Materials Manager to process.

You should set search criteria that causes the schedules running in playout channels to appear in the search results. This may prevent Missing Materials Manager deleting media for events that are temporarily removed from a live schedule (e.g. in a cut-and-paste operation) and then restored; this depends on the short delay before iTX updates the back-up schedule after a modification to the live schedule.

### Set up Missing Materials Manager to check stored schedules

1. In the Missing Materials Manager window, select the Engineering, General tab.
2. Select **Activate Search Criteria**.
3. Do the following to set up PinPoint to search for schedules.
  - Click **Set Search Criteria** to open the PinPoint dialog.
  - Specify the criteria that identifies schedules you want Missing Materials to search.
  - Click **OK** to close PinPoint.

### Event types for checking

Often, it is not necessary for Missing Materials Manager to check every type of event in a schedule for missing media. For example, you might want it to only check for missing video clips.

You use the Filter Event Types panel under the Engineering, Filtering tab to specify what event types you want it to check:

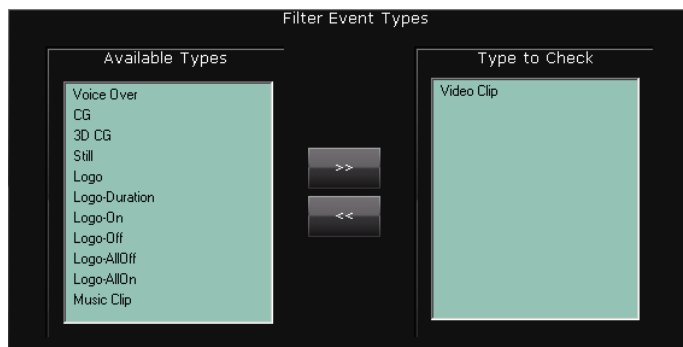

Only event types listed in the Type To Check pane appear in the Missing Materials channel.

### Specify the types of schedule event that Missing Materials Manager should check for missing media

1. In the Missing Materials Manager window, select the Engineering, Filtering tab.
2. Do the following for each event type that is to identify events Missing Material Manager should check.
  - Select the event type in the Available Types list. You may select multiple event types by using the Shift or Control key.
  - Click  to add these event types to the Type to Check list.

If you want to remove an event type from the Type to Check list, select it and click .

## Look-ahead time

When searching a schedule for events with missing media, Missing Materials Manager "looks ahead" to a specific point in the schedule. This point is set by the service look-ahead time – a future period of specified length (e.g. 10 days). Missing Materials Manager checks all schedule events that have a start time that falls within this period; when it finds an event for which there is no media file, it adds the event to the missing-materials list.

Files for events that fall within the look-ahead time are not deleted in the auto-purging process.

You set the look-ahead time in the **Days Look Ahead** box under the Engineering, Channel tab.

### Specify the look-ahead time

1. In the Missing Materials Manager window, select the Engineering, Filtering tab.
2. Enter the number of days for the length of the look-ahead time in the **Days Look Ahead** box.

## Cache-ahead time

Where an event in the missing-materials list requires a media file that is on an archive, Missing Materials Manager can use a Media Watcher that has access to the archive to copy the file to a Media Store. It does this if the start time of the event falls within the service cache-ahead time – a future period of specified length (e.g. 10 days), which cannot be greater than the look-ahead time.

You set the cache-ahead time in the **Days Cache Ahead** box under the Engineering, Channel tab.

### Specify the cache-ahead time

1. In the Missing Materials Manager window, select the Engineering, Filtering tab.
2. Enter the number of days for the length of the cache-ahead time in the **Days Cache Ahead** box.

## Specifying which live schedules Missing Materials Manager should monitor

By default, Missing Materials Manager checks schedules in all live playout channels for events with missing media files. You can configure it so that it only monitors selected playout channels. You may want to do this in a multi-channel system that has multiple instances of Missing Materials Manager, each one dedicated to its own group of channels.

To select a group of playout channels for monitoring, you use the features in the panel under the Engineering, Channels tab:

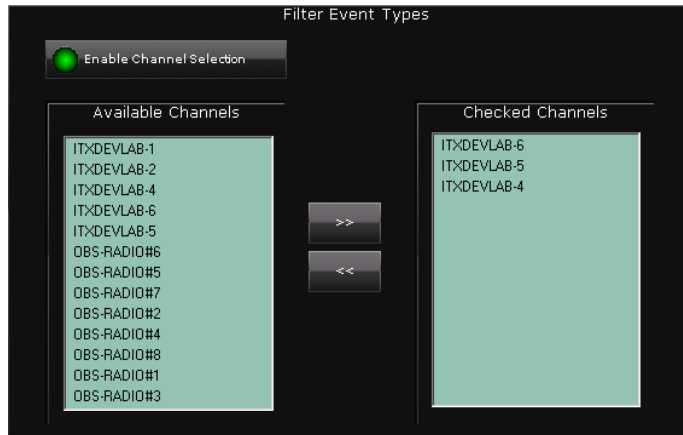

By enabling the channel-selection option, you instruct Missing Materials Manager to search schedules in just selected playout channels for events with missing media files. If this option is not selected, Missing Materials Manager searches schedules in all playout channels.

### Set up Missing Materials Manager to check schedules in selected playout channels

1. In the Missing Materials Manager window, select the Engineering, Channels tab.
2. Select **Enable Channel Selection**.
3. Do the following to select channels for monitoring.
  - Select channels in the Available Channels list.
  - Click  to add them to the Checked Channels list.

You may remove a channel from the Checked Channels list by selecting it and clicking .

## Missing Materials Manager Reporting

Under the Reporting tab, you can schedule Missing Materials Manager to produce reports of missing media files at regular intervals.

Missing Materials Manager can present a report in three ways:

- As a single XML document that contains combined details of all missing media files required for all playout channels.
- As a set of XML documents, with each one containing the details of all missing media files required for a particular channel.
- As a set of XML documents, with each one containing details of a single missing media file. Because of the large total number of individual XML documents that may be created for this type of report, it is best to set a limit to how many are created each minute.

Instead of waiting for a scheduled report, you may manually request an instant one at any time.

Where a missing media file is required for multiple channels, its details appear only for the channel in which it is first needed.

Reports can be converted into any XML format to be compatible with third party traffic or media management systems. This is carried out by means of an XSLT transform definition file in the same way iTX converts BXF traffic information to iTXML.

The **Report Transform File Name** button opens a dialog for you to navigate to the appropriate custom made transform file.

Below this is the **Remove Namespaces on Transformed Reports** toggle button, which you need to select if your traffic system does not support spaces in filenames.

XSLT transform files may either be supplied by the traffic system vendor. If not, and you need advice on how to create them contact ITX Support.

### Set up regular reporting

1. In the Missing Materials Manager window, select the Engineering, Reporting tab.
2. Select **Enabled Timed Reporting**.
3. In the **Report File Folder** box, enter the path and name of a folder where Missing Materials Manager is to put the report documents.
4. Check the entry in the **Report File Base Name** box; this shows the formula that Missing Materials Manager is to use to create report names.

The default entry is: Missing Materials\_{0}\_{1:yyyyMMddhhmmss}.xml

A generic name is followed by two fields in curly brackets. In the first field, Missing Materials Manager enters an indication of the report type (i.e. combined, named single channel or single item); in the second, it enters date and time stamps.

You may change the generic name; but we recommend you do not edit the fields.

5. Specify the length of the interval between reports in the **Report Interval** box.
6. Select a report type in the **Report Type** box.
7. For reports made up of single-item documents, enter a value for the maximum number of these that Missing Materials Manager may create per minute.
8. If you have an XSLT transform file, click the **Report Transform File Name** and browse to the appropriate file.
9. If your traffic system does not support filenames that have spaces in them, toggle the **Remove Namespaces on Transformed Reports** button below.
10. Click **Save**.

Missing Materials Manager restarts with the new configuration. At the specified intervals, it creates reports in one or more XML documents and stores them in the specified folder.

### Request an instant report

1. Check the settings (report base name, report type, etc.) for the report properties are suitable.
2. Click **Create Report**.

Missing Materials Manager immediately creates a report (in one or more XML documents) and stores it in the specified folder.

### Note:

- An iTX Desktop component – the Missing Material Run Report button – can also be used to request instant reports. You may add the component to an iTX Desktop layout.

## Configuring an iTX Desktop to accept commands from a keyboard or hard panel

There are two aspects of an iTX Desktop that enable certain operations to be controlled by a keyboard or hard panel:

- Component inputs. These are connections on a layout component, such as the Playout Controls, through which the component accepts commands to perform certain actions (Cue Next, Take Next, etc.).
- iTX Desktop macros (small programs). These perform layout-selection tasks and actions that are available through commands in iTX Desktop menus. For example, switching to the next layout; or putting a layout in the editing mode.

To control component actions, you need to assign keyboard shortcuts or hard-panel controls to the component inputs – we describe the process as input mapping. A number of layout components support the process; see "Components that support input mapping", page 349.

This diagram shows an example of input mapping for the Media Viewer:



iTX Desktop macros are stored with the iTX Desktop and are available on all layouts. For the actions that these control, you need to assign keyboard shortcuts or hard-panel controls to the macros.

### Component-input mapping

You can map inputs while the displayed layout is in the normal operating mode.

When you save the mapping, you may make it available either to just an individual user (i.e. the user currently logged on at the workstation) or to all users who do not have their own input mapping.

#### Assign a keyboard shortcut or hard-panel control to an action of a layout component

1. On an iTX Desktop layout, right-click a component to display the component menu (you need to click near the edge of the component). Select **Manage Component Input Mappings**:

Configuring an iTX Desktop to accept commands from a keyboard or hard panel

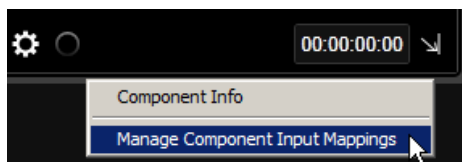

The Input/Output Mappings dialog opens. This shows a list of the actions that can be triggered through component inputs:

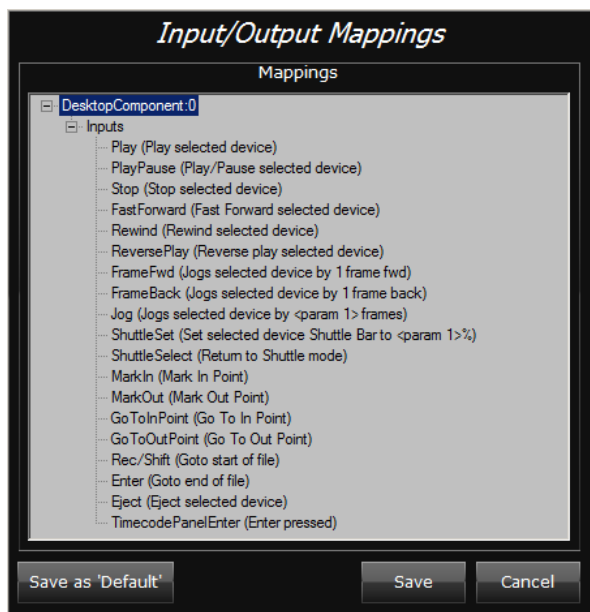

2. Right-click an action and select **Assign Input** from the displayed menu:

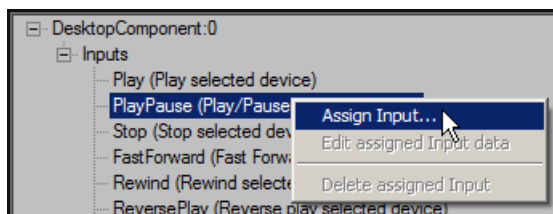

The Assign Input dialog opens:

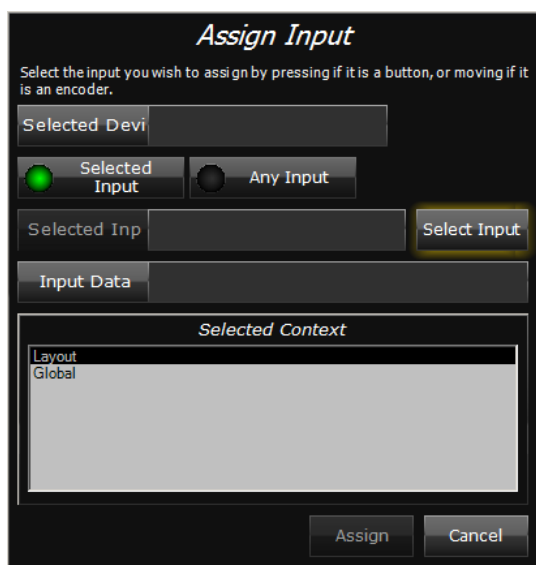

3. Ensure **Selected Input** is selected.
4. Do one of the following to set a keyboard or hard-panel operation.
  - Press a key or key combination on the keyboard. The **Selected Device** box shows keyboard as the device type; the **Selected Input** box shows the keyboard shortcut.
  - Operate a control on the hard panel. The **Selected Device** box shows the hard panel as the device type; the **Selected Input** box shows the control name.
  - Click **Select Input** to display the Select Input dialog. This shows the layout of controls on an installed hard panel:

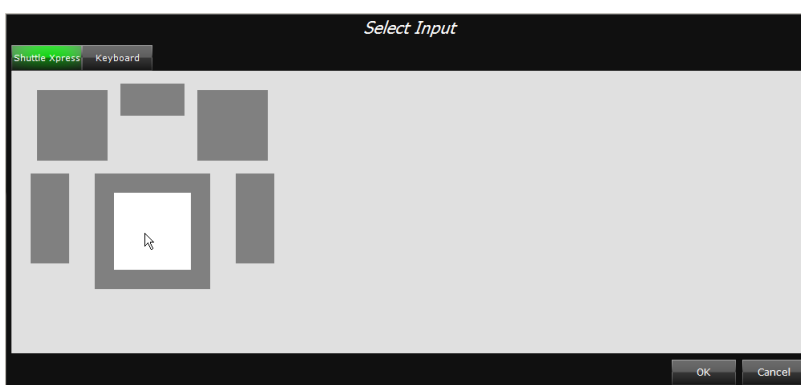

Device selection buttons, in the top left of the dialog, enable you to switch between the hard-panel layout and an on-screen keyboard.

Operate a control on the hard panel; or press a key (or key combination) on either your workstation keyboard or the on-screen keyboard. Click **OK** to close the Select Input dialog.

The **Selected Device** box in the Assign Input dialog shows the device type; the **Selected Input** box shows the control name or keyboard shortcut.

5. In the Selected Context pane of the Assign Input dialog, select an option to specify when the input mapping is to work:
  - Select **Layout** if the input mapping is to work only when the current layout is selected.
  - Select **Global** if it is to work when any layout is selected.



Where the component you are configuring appears in a number of groups on the layout, you may select a different option:

- Select **Group n** (where *n* is the group number) if the input mapping is to work only when that group is in focus; i.e. when the mouse pointer is over the group.

6. Click **Assign**.

The Assign Input dialog closes.

7. Do one of the following to save the mapping.

- Click **Save** to save the mapping as the personal configuration of the current user – the mapping is not available to other users who log onto the layout.

A confirmation dialog opens; click **OK** to close this, together with the Input/Output Mapping dialog.

- Click **Save as 'Default'** to save the mapping as the default configuration for the layout – the mapping is then available to all users who do not have their own personal settings.

A confirmation dialog opens; click **OK** to close this, together with the Input/Output Mapping dialog.

8. Ensure iTX performs the required action for the mapped hard-panel control or keyboard shortcut.

**Note:**

- The **Input Data** box of the Assign Input dialog is only used in special cases, where the mapping carries a value entered in the box. For most input mappings, you leave the box empty.
- To change an input mapping, you need to delete it and assign a new control to the input. (See below, "Delete an input mapping".)

## Delete an input mapping

1. Right-click a component to display the component menu. Select **Manage Component Input Mappings**.

The Input/Output Mappings dialog opens.

2. Right-click an input mapping; select **Delete assigned Input** from the displayed menu.

iTX prompts you to confirm you want to delete the input mapping.

3. Click **Yes**.

4. On the Input/Output Mappings dialog, click **Save**.

## Editing data for an input mapping

Some special input mappings carry a value which is entered in the **Input Data** box of the Assign Input dialog. To edit this value, you display the Assign Input dialog by right-clicking the mapping and selecting **Edit assigned Input data**:

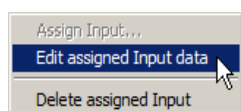

## View details of all input mappings

You can view details of all the input mappings that are relevant to a selected layout.

1. On the iTX Desktop, click a layout selection button to display a layout.
2. Right-click the title bar (or a clear area of the layout) to display the iTX Desktop menu. Select **Show Available Inputs**:

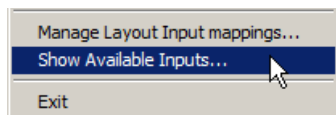

The Available Input Mappings dialog appears:

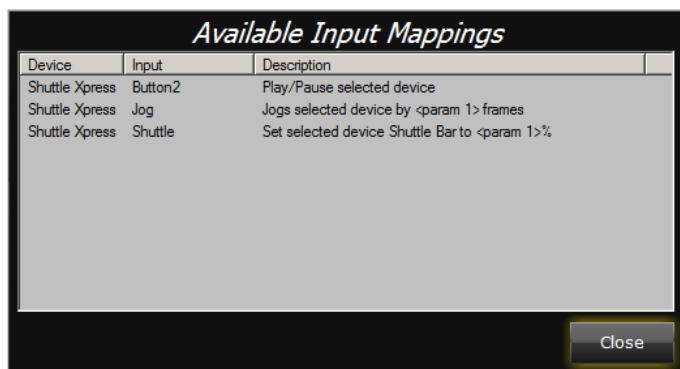

The dialog lists the input mappings for layout components.

3. Click **Close** to close the dialog.

## Components that support input mapping

Component	Component action
Playout Controls	Cue the next event
	Take the next event
	Hold the next event
	Skip the next event
	Roll under the current event
Playout Selected Item Controls	Take the selected event
	Cue the selected event
Sequence Controls	Start a sequence
	End a sequence
Live iTX GFX Control	Run a graphics script
Live Caption Control	Put a CG on-air
	Update an on-air CG
	Select a playout channel to play a CG
Live Caption Control (Small)	Put a CG on-air
Live Logo Control	Put a logo on-air
Live PreRecorded VO Control	Put a voiceover on-air
Live Video Control	Load a clip
	Switch to the live feed
	Add an event to the live schedule
	Take an event in the live schedule
	Select a cut transition
	Select a mix transition
	Select a v-fade transition
	Mark an in-point
	Mark an out-point
	Preview the in-point
	Preview the out-point
Source Take Button	Take a route
VTR Control	Play

Component	Component action
	Stop
	Fast forward
	Rewind
	Reverse
	Jog forward (1 frame)
	Jog backward (1 frame)
	Jog forward (specified number of frames)
	Position the shuttle bar (at a specified percentage of the bar)
	Select the shuttle mode
	Display the numeric keypad
	Select Enter on the numeric keypad
	Select 1 on the numeric keypad
	Select 2 on the numeric keypad
	Select 3 on the numeric keypad
	Select 4 on the numeric keypad
	Select 5 on the numeric keypad
	Select 6 on the numeric keypad
	Select 7 on the numeric keypad
	Select 8 on the numeric keypad
	Select 9 on the numeric keypad
	Select 0 on the numeric keypad
	Select the backspace key on the numeric keypad
Encoder Control	Mark an in-point
	Mark an out-point
	Prepare the system for ingest
	Position a clip (in a VTR) at the in-point
	Position a clip (in a VTR) at the out-point

Component	Component action
Media Viewer	Play
	Stop
	Fast forward
	Rewind
	Reverse
	Jog forward (1 frame)
	Jog backward (1 frame)
	Jog forward (specified number of frames)
	Position the shuttle bar (at a specified percentage of the bar)
	Select the shuttle mode
	Mark an in-point
	Mark an out-point
	Position a clip at the in-point
	Position a clip at the out-point
	Eject a clip
	Position a clip at its start
Position a clip at its end	
Select Enter on the numeric keypad	
Segmenting Control	Add a segment

## Macro mapping

An iTX Desktop macro belongs to one of two categories:

- A global macro works on all layouts in an iTX Desktop view.
- An edit-mode macro works when the selected layout is in the editing mode.

By mapping a macro to a keyboard-shortcut or hard-panel control, you enable it to be run from the keyboard or hard-panel.

### Assign a keyboard shortcut or hard-panel control to an iTX Desktop macro

1. On the iTX Desktop, click a layout selection button to display a layout.

- Right-click the title bar (or a clear area of the layout) to display the iTX Desktop menu; select **Manage Layout Input mappings**.

The Input/Output Mappings dialog appears:

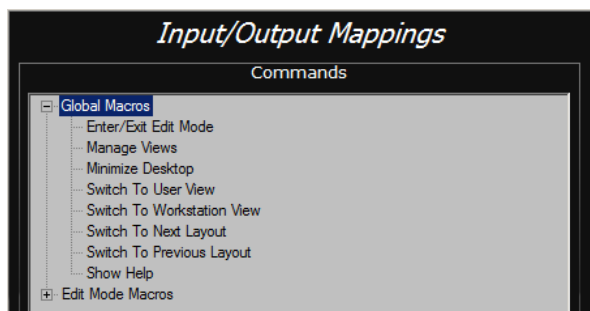

The Commands list shows the available macros, arranged in two categories: Global Macros and Edit Mode Macros.

You may expand and collapse categories by clicking the plus and minus buttons next to the category names.

- Right-click a macro and select **Assign Input** from the displayed menu.

The Assign Input dialog opens:

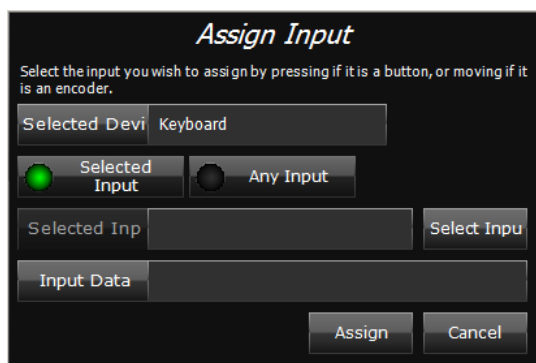

- Ensure **Selected Input** is selected.
- Do one of the following to assign a keyboard or hard-panel operation to the macro.
  - Press a key or key combination on the keyboard. The **Selected Device** box shows keyboard as the device type; the **Selected Input** box shows the keyboard shortcut.
  - Operate a control on the hard panel. The **Selected Device** box shows the hard panel as the device type; the **Selected Input** box shows the control name.
  - Click **Select Input** to display the Select Input dialog. This shows the layout of controls on an installed hard panel.

Device selection buttons, in the top left of the dialog, enable you to switch between the hard-panel layout and an on-screen keyboard.

Operate a control on the hard panel; or press a key (or key combination) on either your workstation keyboard or the on-screen keyboard. Click **OK** to close the Select Input dialog.

The **Selected Device** box in the Assign Input dialog shows the device type; the **Selected Input** box shows the control name or keyboard shortcut.

- Click **Assign**.

The Assign Input dialog closes.

- Do one of the following to save the mapping.

- Click **Save** to save the mapping as the personal configuration of the current user – the mapping is not available to other users who log onto the layout.

A confirmation dialog opens; click **OK** to close this, together with the Input/Output Mapping dialog.

- Click **Save as 'Default'** to save the mapping as the default configuration for the layout – the mapping is then available to all users who do not have their own personal settings.

A confirmation dialog opens; click **OK** to close this, together with the Input/Output Mapping dialog.

8. Ensure iTX performs the required action for the mapped hard-panel control or keyboard shortcut.

**Note:**

- To change a mapping, you need to delete it and assign a new control to the macro. (See below, "Delete the mapping for an iTX Desktop macro".)
- After you assign a control to run a macro, **Edit assigned Input data** appears in the displayed menu when you right-click the macro. You do not use this option; there is no input data for an iTX Desktop macro.

## Delete the mapping for an iTX Desktop macro

1. On the iTX Desktop, click a layout selection button to display a layout.
2. Right-click the title bar (or a clear area of the layout) to display the iTX Desktop menu; select **Manage Layout Input mappings**.

The Input/Output Mappings dialog appears.

3. Right-click an input mapping; select **Delete assigned Input** from the displayed menu. iTX prompts you to confirm you want to delete the mapping.

4. Click **Yes**.

5. On the Input/Output Mappings dialog, click **Save**.

The iTX Desktop displays a dialog when the process is complete. Click **OK** to close the dialog.

# Using iTX with the XML Adaptor

## About the XML Adaptor

The XML Adaptor is an optional iTX service. It sends XML messages about current schedule events to a third-party system, such as an Electronic Programme Guide (EPG) application.

The third-party system connects to the XML Adaptor by TCP on a known port (usually 10540). After the connection is established, the XML Adaptor sends an initial schedule content message; it then sends schedule update messages at regular intervals.

You may install the XML Adaptor on the Database Server machine.

### License dongle

To run the XML Adaptor, the Database Server machine must have a hardware License key, or "dongle", inserted in one of its USB slots. This authenticates the iTX software and allows you to use the software once the License is registered in the iTX system.

## Installing the iTX XML Adaptor module

1. Double-click **Setup.exe** in the installation folder, iTX Suite, to start the installer.

The installer displays the iTX Installer dialog.

2. Click **Select Software** to open the Select Software to Install dialog.
3. Expand the External Interfaces category and select **iTX XML Adaptor**.

Click **OK** to close the Select Software to Install dialog.

The iTX Installer dialog shows the components in the selected module.

4. Click **Continue**.

The installer performs the installation. In doing so, it places a configuration file in a folder with the program executable. The default path of the folder is:

C:\Program Files (x86)\iTX 2.0\Services\iTXXMLAdaptor

The program configuration file is called "DefaultConfiguration.xml".

5. Click **Finish** to close the iTX Installer dialog.

## Setting up multiple service instances

To make the best use of available machine resources and ease the load on the XML Adaptor, you may run multiple instances of the service on one machine.

To do this, you add an entry for each extra instance under the Services tab of the Server Controller Configuration tool. In this entry you assign a unique name to the instance by using the start-up parameter "-id" (e.g. -id Chann1). [More details](#), page 215.



## Configuring the XML Adaptor

Starting the Server Controller on the same machine automatically starts the XML Adaptor. The first time it does this, the service loads a default configuration from its configuration file, DefaultConfiguration.xml.

You edit the configuration in the service window. This displays a configuration pane, under the Config tab:

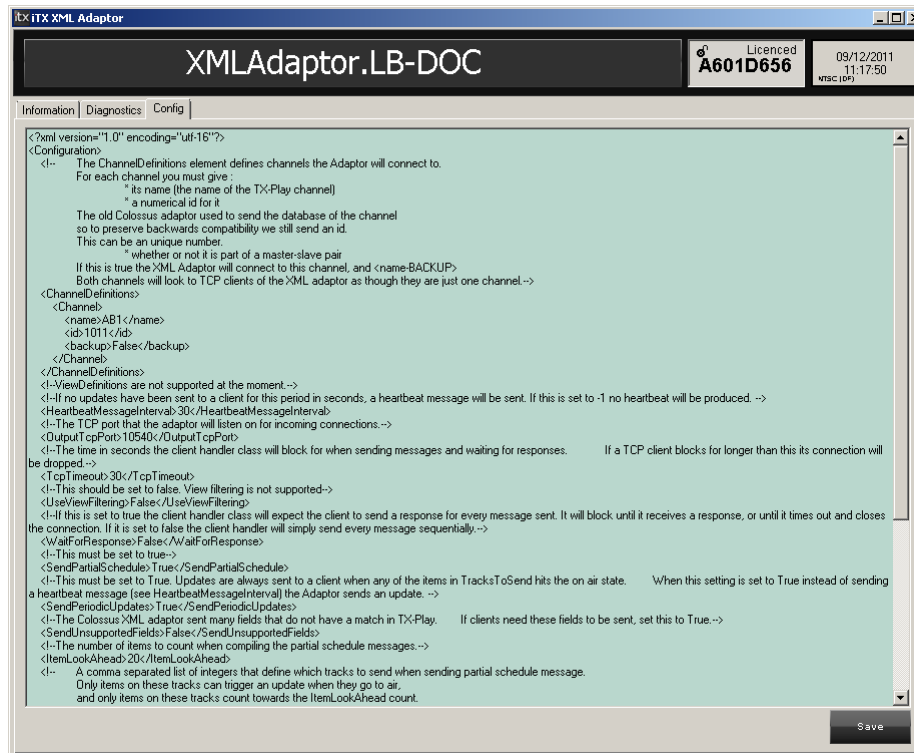

The XML Adaptor can send schedule-update details from any number of iTX channels. You specify these channels in the configuration pane. You can also configure settings for the schedule-update and heartbeat messages. (A heartbeat message is sent when there are no schedule update messages for a while; it ensures the third-party system remains connected to the XML Adaptor.)

iTX saves the configuration in the System Database; it loads it from there each time the service is restarted. It does not change the default-configuration file.

### Configure the XML Adaptor

You need to do this for each instance of the service:

1. Select the Config tab of the XML Adaptor window.
2. Enter the configuration details. See below, "Configuration settings".
3. Click **Save** to save the configuration.
4. Restart the service.

## Configuration settings

Below, we list the possible configuration settings. For many of these, we recommend you do not change the default value except where we tell you to do so.

Setting	Description/comments
ChannelDefinitions (Specify the channels the XML Adaptor sends schedule update messages for.)	
Channel (Details for a single channel, or a pair of master-slave channels.)	
name	Channel name.
id	Unique channel identification name or number.
backup	An indication of whether or not the channel is part of master-slave pair. Set to "true" if so; or "false", if there is no back-up channel.
HeartbeatMessageInterval	The interval (in seconds) after which the XML Adaptor sends a heartbeat message, containing the status of each channel, if there is no schedule update message in the meantime.
OutputTcpPort	The number of the TCP port that third-party systems use to connect to the XML Adaptor. Usually, this is 10540.
TcpTimeout	How long (in seconds) that the XML Adaptor waits when there is no response from a third-party system before closing the connection.
UseViewFiltering	Set to "false". The XML Adaptor does not use this setting.
WaitForResponse	An indication of whether or not the XML Adaptor should get a response from a third-party system for each message sent. If the setting is "true", the XML Adaptor does not send another message until it gets such a response. Set to "false" if the XML Adaptor does not require a response from a third-party system.
SendPartialSchedule	Each schedule update message contains the number of schedule events specified in the ItemLookAhead setting (see below). Set to "true".
SendPeriodicUpdates	The XML Adaptor sends schedule update messages when an event plays out, and heartbeat messages at the interval specified in the HeartbeatMessageInterval setting. Set to "true".

Setting	Description/comments
SendUnsupportedFields	Usually, this is set to "false". You may set it to "true" if a third-party system requires the information in unsupported fields.
ItemLookAhead	The number of events sent in each partial schedule update message.
TracksToSend	The types of asset to send details of in each partial-schedule update message. This is a comma-separated list of the numbers used to identify the asset types. See below "Media types in schedule update messages". Leave this setting blank to send details of all asset types in schedule update messages.
ApplyTimezoneOffsetToItemTimes	Set to "true" if the timezone offset for a schedule item is applied to the start time, preset time and current time for the event in the schedule update message. Set to "false" if the start time, preset time and current time for each event are displayed without an offset.
HeartbeatCurrentTimeOffset	The offset (in minutes) for the current time displayed in a heartbeat message. This offset can be negative.

### Media types in schedule update messages

Identification number	Media types
0	Video clip, voiceover clip, live event
1	Still image, music clip, comment, slide show
2	CG, graphics script
3	Logo
4	GPI
5	Auto select event
6	Split break
7	Subtitle file
9	Sequence
10	Stored schedule

# Using iTX with the Alerts Forwarding Service

## About the Alerts Forwarding Service

The Alerts Forwarding Service is an optional iTX service. It sends system alerts that the Alerts Service has generated to an external SNMP monitoring system.

To use this service, you usually install it on the Time Server machine. You may, however, install it on any server in your iTX system.

## Installing the Alerts Forwarding Service module

1. Double-click **Setup.exe** in the installation folder, iTX Suite, to start the installer.  
The installer displays the iTX Installer dialog.
2. Click **Select Software** to open the Select Software to Install dialog.
3. Expand the External Interfaces category and then the Alert Forwarding Server category; select **Alerts Forwarding Service – SNMP Plugin**.  
Click **OK** to close the Select Software to Install dialog.  
The iTX Installer dialog shows the components in the selected modules.
4. Click **Continue**.  
The installer performs the installation.
5. Click **Finish** to close the iTX Installer dialog.  
The Server Controller on the same machine automatically starts the Alerts Forwarding Service.

## Configuring the Alerts Forwarding Service

To configure the Alerts Forwarding Service, you need to enter the connection details that the service is to use to connect to an external SNMP monitoring system. For this, you use the Alerts Forwarding SNMP Plugin Configuration tool:

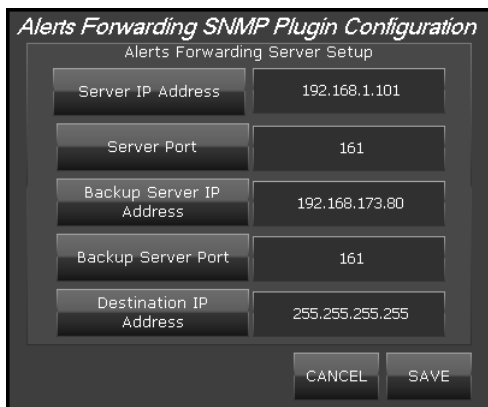

The image shows a configuration dialog box titled "Alerts Forwarding SNMP Plugin Configuration" with a subtitle "Alerts Forwarding Server Setup". It contains five input fields with their respective values:

Field	Value
Server IP Address	192.168.1.101
Server Port	161
Backup Server IP Address	192.168.173.80
Backup Server Port	161
Destination IP Address	255.255.255.255

At the bottom of the dialog are two buttons: "CANCEL" and "SAVE".

You may need to add the tool to a suitable layout.

## Stop the Alerts Forwarding Service

You should stop the Alerts Forwarding Service before you configure it.

1. Select the Controlled Services information tab in the Server Controller window.
2. Right-click the **Alerts Forwarding Service** entry in the controlled services list; click **Stop Service** from the displayed menu.

The Server Controller stops the Alerts Forwarding Service.

## Add the Alerts Forwarding SNMP Plugin Configuration tool to a layout

1. Right-click the title bar (or a clear area of the layout) to display the iTX Desktop menu. Select **Edit**.
2. In the Toolbox, expand the categories ITX and VIEW. Select **Alerts Forwarding SNMP Plugin Editor** and drag it to a clear area of the layout.

**Note:** If the Toolbox does not contain the Alerts Forwarding SNMP Plugin Editor, you need to install the Alerts Forwarding Service – SNMP Plugin Desktop Components module on the iTX Desktop Client workstation.

3. The Alerts Forwarding SNMP Plugin Configuration tool appears on the layout.

## Enter connection details

1. Enter the Alerts Forwarding Service connection details in the configuration tool:
  - The IP address of the machine on which the Alerts Forwarding Service is running in the **Server IP Address** box.
  - The port number (usually 161) in the **Server Port** box.
  - In a system that includes a back-up Alerts Forwarding Service, the IP address of the machine on which this is running in the **Backup Server IP Address** box.
  - In a system that includes a back-up Alerts Forwarding Service, the port number (usually 161) in the **Backup Server Port** box.
  - The IP address of the external SNMP monitoring system in the **Destination Address** box. This may be a broadcast (255.255.255.255), directed broadcast (192.168.100.255) or unicast (192.168.100.100) address.
2. Click **Save**.

## Restart the Alerts Forwarding Service

1. Select the Controlled Services Information tab in the Server Controller user interface.
2. Right-click the **Alerts Forwarding Service** entry in the controlled services list; click **Start Service** from the displayed menu.

The Server Controller starts the Alerts Forwarding Service.

## Testing the Alerts Forwarding Service

Once the Alerts Forwarding Service is running, you can test the operation of the service and check its logs.

### Test the operation of the Alerts Forwarding Service

1. Select the Alerts Forwarding Service window.
2. Select the **Trace Logs** sub-tab.
3. Ensure the Alerts Forwarding Service creates log lines for "Alerts Forwarding Service is Available" and "SNMP Agent opened on port 161".
4. Generate an alert in your iTX system (for example, Schedule Empty) and ensure the Alerts Forwarding Service creates a log line for "SNMP Plugin Notification Sent: Alert Id: x Status: y" where x is the alert ID number and y is the current status of the alert.

### Check the logs for the Alerts Forwarding Service

The Alerts Forwarding Service generates daily log files, which it stores in a folder on the machine running the Alerts Forwarding Service. The path of the folder is typically:

C:\Program Files\iTX 2.0\Services\Alerts Forwarding Service

1. Open the log file for the current day and ensure it contains information for any alerts that the Alerts Service has generated.

## iTX Emergency Alerts Service

iTX v2 has always supported the playout of FCC Emergency Alert System (EAS) alerts over a background still image. This functionality has now been extended to allow alerts to play out over a video-clip or live event that is currently on air. There are new desktop components and a layout that facilitates the operation and configuration of this as detailed in the **iTX Emergency Alerts Service User Manual**.

## Using iTX with the RSS Streamer

The RSS Streamer is an optional iTX service. It enables iTX to capture an RSS feed (containing information such as news headlines) from a website and save the text of the feed in an output file. An operator can include the text from the output file in a CG.

The service runs under the Server Controller, but does not connect to any other iTX service. You may install it on any machine that has internet access.

### Installing the RSS Streamer module

1. Double-click **Setup.exe** in the installation folder, iTX Suite, to start the installer.  
The installer displays the iTX Installer dialog.
2. Click **Select Software** to open the Select Software to Install dialog.
3. Expand the Utilities category and select **RSS Streamer**.  
Click **OK** to close the Select Software to Install dialog.  
The iTX Installer dialog shows the components in the selected module.
4. Click **Continue**.  
The installer performs the installation. In doing so, it places a configuration file in a folder with the program executable. The default path of the folder is:  
C:/Program Files/iTX 2.0/Services/RSS Streamer  
The program configuration file is called "RssFeeds.txt".
5. Click **Finish** to close the iTX Installer dialog.

### Starting the RSS Streamer

Starting the Server Controller on the same machine automatically starts the RSS Streamer.

## Configuring the RSS Streamer

To configure the RSS Streamer, you use the features under the Configure RSS Feeds tab of its user interface:

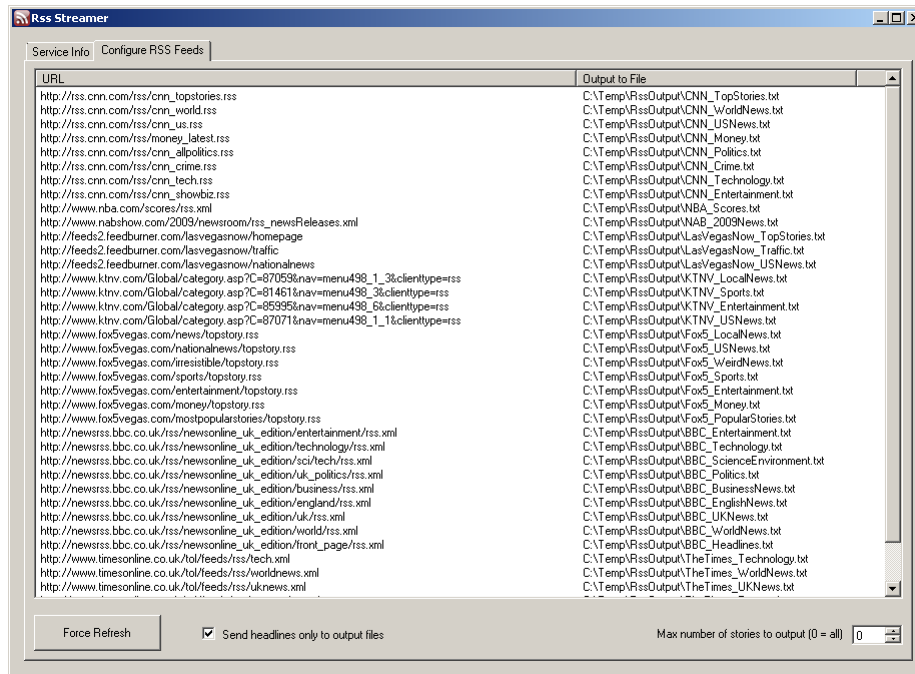

Under this tab, the RSS Streamer shows a list of RSS feeds that the service is set up to capture. For each feed, there is a file path showing the location of the output file for the feed.

To be able to include RSS-feed text in a CG, an iTX Desktop Client workstation must have access to the folder containing the output files. You should check that the folder sharing property is set to allow this.

### Add an RSS feed to the list

1. Right-click the RSS Feed list to display the RSS Feed menu; select **Add RSS Feed**.

The RSS Streamer displays the Edit Details For The RSS Feed dialog.

2. Enter the website address (URL) of the RSS feed in the **Rss URL** box.
3. Do one of the following to enter the output-file details.

- Enter a folder path and file name in the **Output File** box.
- Click the search button, , to display the Save RSS Feed dialog. Select a folder to hold the output file. Enter a file name in the **File name** box; click **Save**.

The path and file-name details appear in the **Output File** box when you close the dialog.

4. Click **OK** to close the Edit Details For The RSS Feed dialog.

The RSS feed appears in the RSS Feed list.



**Note:**

- You can also add an RSS feed to the list by editing the program configuration file. [More details](#), page 364.

**Delete an RSS feed**

1. Select a feed in the RSS Feed list. You can select multiple feeds by pressing Shift or Control as you click their entries.
2. Right-click the selected RSS feed to display the RSS Feed menu; select **Delete Selected Items**.

The RSS feed is removed from the RSS Feed list. Any CG containing the text of the feed no longer displays the text.

**Note:**

- You can also remove an RSS feed from the RSS Feed list by editing the program configuration file. [More details](#), page 364.

**Change the number of headlines the RSS Streamer includes in an output file**

By default, the RSS Streamer captures all the headlines for an RSS feed. You can configure the service to capture fewer headlines.

1. In the **Max number of stories to output** box, enter the number of headlines that the RSS Streamer is to include in the output file.

This setting applies to all feeds appearing in the RSS Feed list.

**Note:**

- Ensure the entry in the **Max number of stories to output** box is 0 if you want the RSS Streamer to include all headlines in the output file.

**Change the type of information the RSS Streamer includes in an output file**

By default, the RSS Streamer captures just the headlines for an RSS feed. You can set up the service to include the full text of each article in the output file.

1. To set up the RSS Streamer to include the full text of each article in the output file, clear the check box for "Send headlines only to output files".

This setting applies to all feeds appearing in the RSS Feed list.

**Refresh the RSS feed content**

Every 30 minutes, the RSS Streamer checks the feeds in the RSS Feeds list for new content. You can refresh the RSS feed content manually.

1. Click **Force Refresh** to instruct the RSS Streamer to check the RSS feeds for new content.

## Edit the program configuration file

The program configuration file contains a list of the RSS feeds, and their output files, that appear in the RSS Feed list. You can add an RSS feed to the configuration file; you can also remove a feed from the file.

You do not need to edit the program configuration file if you use the user interface to configure the RSS Streamer.

1. Open the configuration file, "RssFeeds.txt".

The configuration file lists the website address (URL) and output file for each RSS feed. The entry for each RSS feed is on a separate line; the address and output file are comma-separated. The entries in the file have the following format.

```
http://website address,output file path.txt
```

2. Edit the configuration file so that it contains the RSS feeds that you want to be available to include in a CG.
3. Save the configuration file.
4. Close the window of the RSS Streamer to restart the service.

The Server Controller restarts the service; the RSS Feeds list is updated.

## Using iTX Workflow

A number of tasks that can be performed in an iTX system are handled by a group of services and associated components that we call iTX Workflow. The tasks are defined as jobs in workflow processes. Examples of workflow jobs are:

- The creation of proxy versions of video files.
- The creation of keyframes from video files.
- The exporting of media files to a specified location.

### About the Workflow Service and job services

Workflow jobs are managed through a job list that is held by the OPUS 2 Service. They are done by a number of specialist services, called job services. There are different types of job service for different types of workflow job (e.g. creating “browse copies” of video files, or capturing keyframes).

An iTX service called the Workflow Service creates some types of job, based on requests from other parts of a workflow system:

- Automatic jobs are prompted by workflow definitions called Media Rules.
- Some manually triggered jobs use workflow definitions called MediaFlow Processes.

See later in this section, “Media Rules and MediaFlow Processes”.

Other jobs may be created in response to requests by services or operators in an iTX system

The following diagram shows some of the main components that are involved in the creation and handling of jobs.

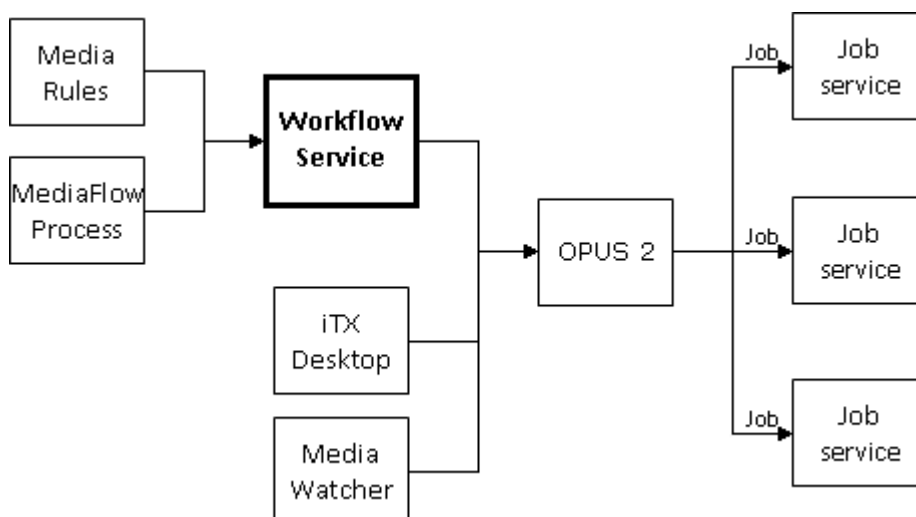

Each job service scans the job list, takes the first available job of the type it can do and does it. The job service repeats this cycle until there are no more jobs that it can do. It then waits for another suitable job to appear on the list, before continuing the process.

Job services include the following:

- The Proxy Generation Service.
- The Keyframe Generation Service.
- The File Copy Service.
- The Workflow Service.

You may have multiple job services of the same type, sharing jobs, in your system.

## Proxy Generation Service

The Proxy Generation Service creates low-bit-rate proxy files in MPEG-4 format. We call these files browse copies, since multiple users can browse them at the same time without overloading the network.

The generation of a proxy file is a job that the Proxy Generation Service handles in response to a request that may be made in one of three ways:

- By a Media Watcher. The Media Watcher may be set up to request the proxy generation of video files placed in an Inbox folder on an iTX Media Store.
- By an operator using an action button (for instance, one on the Asset layout) at an iTX Desktop Workstation.
- By a Media Rule.

To use the service, you must install it on its own machine in the iTX system.

If selected for installation, a Proxy Generation Service configuration dialogue box pops up at the point the service is being installed, allowing you to select some options regarding the type of browse media you would like generated. See the section Install a job service on page 380.

## Keyframe Generation Service

The Keyframe Generation Service captures keyframes (.jpg images) at regular intervals from broadcast-quality video files. It stores the keyframes in the Media folder on the main iTX Media Store.

The service performs this task for a Media Watcher that is set up for capturing keyframes. As video files are placed in the Inbox, the Media Watcher requests the Keyframe Generation Service to create keyframe-generation jobs.

A keyframe-generation job can also be prompted by a Media Rule. See below, “Media Rules and MediaFlow Processes”.

To use the service, you must install it on its own machine in the iTX system.

## File Copy Service

The File Copy Service can copy any of the media files associated with an asset (broadcast-quality file or proxy file) to an external location.

The external location may be a machine in a remote iTX domain or a Windows folder in a third-party system (e.g. one on an Apple Final Cut Pro workstation).

The File Copy Service can run on a machine with other iTX services.

## Media Rules and MediaFlow Processes

In the design of a workflow process, a number of workflow activities are combined to form a workflow definition. Designing workflows can be complex and normally requires the skills of a Grass Valley workflow designer.

In the iTX installation folder, however, there are a number of components that contain prepared workflow definitions. You can install these components and configure them to suit individual system requirements. The components fall into two types: Media Rules and MediaFlow Processes.

Media Rules are workflow definitions for automated processes; they prompt the Workflow Service to create jobs at specified times for assets that meet specified criteria. In iTX v2, there are three available Media Rules:

- **Keyframe All** causes the Workflow Service to create keyframe-generation jobs. The jobs are to find video clips that meet certain criteria and create keyframes for them.
- **Proxy All** causes the Workflow Service to create proxy-generation jobs. The jobs are to find video clips that meet certain criteria and create proxy files for them.
- **Purge Expired Assets** causes the Workflow Service to find and delete assets that have an expiry date that has passed.

Media Flow Processes are workflow definitions for manually triggered jobs; they include details of job properties. In iTX v2, there are two available MediaFlow Process:

- **Export Asset** causes the Workflow Service to create file-copying jobs. The jobs are to copy selected video files to a specified location. The location is a property of the Media Flow Process.
- **Multi-Domain Content Transfer** causes the Workflow process to create multi-domain content-transfer jobs. The jobs are to copy selected media files and metadata from a remote domain to the local domain.

## Installing iTX Workflow components

All iTX systems that use iTX Workflow require the Workflow Service.

Depending on what types of job a system is to handle, other services and components are required to interact with the Workflow Service. You need to install various iTX software modules, as we describe below, by selecting them when running the iTX installer.

### Selection of software modules

To enable iTX to use iTX Workflow, you need to install this module from the Workflow Category:

- The Workflow Server.

To enable the system to perform particular jobs, you need to install job-provider modules from the Content Management category:

- The File Copy Server.
- The Keyframe Generation Server.
- The Proxy Generation Server.

To enable the Workflow Service to create jobs based on Media Rules, you need to install components from the Workflow category. From the Standard Media Rules module, you may install these components:

- Media Rule Keyframe All.
- Media Rule Proxy All.
- Media Rule Purge Expired Assets.

To enable the Workflow Service to create jobs based on MediaFlow Processes, you need to install components from the Workflow category. From the Standard MediaFlow Processes module, you may install these components:

- Media Flow Export Asset.
- Media Flow Multi-Domain Content Transfer

## Install the Workflow Service

You may install the Workflow Service on the same machine as the OPUS service.

1. Double-click **Setup.exe** to start the iTX installer.
2. Display the Select Software To Install dialog. [More details](#), page 28.
3. Select **Workflow Server** from the Workflow category.
4. Click **Continue**.

The installer installs the Workflow Service. The progress bar at the bottom of the dialog shows the operation progressing.

For some tasks, the installer displays a dialog requesting you to enter certain system details.

In the iTX Domain Configuration dialog, enter domain and Locator Service information. [More details](#), page 32.

In the Add Tables To Database dialog, do the following.

- Check the name of the System Database appears in the **Database** box.
- Check the network name of the Database Server appears in the **Database Server** box.
- Specify the database connection method (i.e. by trusted or named user).
- Click **Save**. The Add Tables To Database dialog closes.

The installer adds the iTX tables to the System Database.

The installer creates a configuration file, containing the details you enter, in an application-data folder under the logged-on username.

5. Click **Finish** to close the iTX Installer dialog.

A folder for the installed components appears in the Program Files\iTX 2.0\Services folder.

## Install a job service

Both the Keyframe Generation Service and the Proxy Generation Service require their own machine to run on. The File Copy Service may run on a machine with other services.

1. Double-click **Setup.exe** to start the iTX installer.
2. Display the Select Software To Install dialog. [More details](#), page 28.
3. Select the required module from the Content Management category. You may select any of these:
  - **File Copy Server.**
  - **Keyframe Generation Server.**
  - **Proxy Generation Server.**
4. Click **Continue**.

The installer installs the selected service.

5. Click **Finish** to close the iTX Installer dialog.

A folder for the installed components appears in the Program Files\iTX 2.0\Services folder.

### Note:

- Before you can run the File Copy Service, you need to configure it to use a limited amount of network bandwidth. [More details](#), page 373.

## Install Media Rules components

1. Double-click **Setup.exe** to start the iTX installer.
2. Display the Select Software To Install dialog. [More details](#), page 28.
3. From the Standard Media Rules module in the Workflow category, select the components your system needs. You may select any of these:
  - **Media Rule Keyframe All.**
  - **Media Rule Proxy All.**
  - **Media Rule Purge Expired Assets.**

4. Click **Continue**.

The installer installs the selected components.

5. Click **Finish** to close the iTX Installer dialog.

## Install MediaFlow Processes components

1. Double-click **Setup.exe** to start the iTX installer.
2. Display the Select Software To Install dialog. [More details](#), page 28.

3. From the Standard MediaFlow Processes module in the Workflow category, select the components your system needs. You may select any of these:
  - **Media Flow Export Asset.**
  - **Multi-Domain Content Transfer.**
4. Click **Continue**.  
The installer installs the selected components.
5. Click **Finish** to close the iTX Installer dialog.

## Configuring workflow definitions in the Workflow Service

After installing any workflow definition (Media Rule or MediaFlow Process), you need to configure it by using the Workflow Configuration tool:

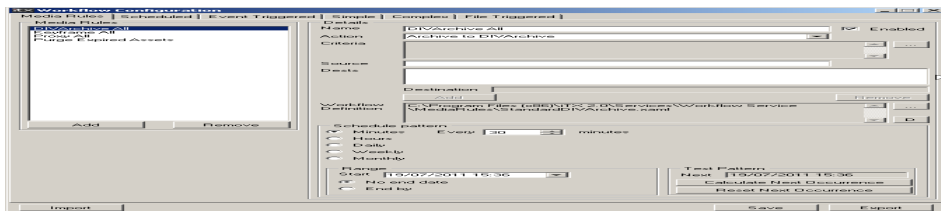

This displays tabs for different types of workflow definition.

### Open the Workflow Configuration tool

1. Do one of the following to open the Workflow Configuration tool.
  - Select the Workflow Service Config shortcut in the Windows Start menu.
  - Double-click the Workflow Service Config shortcut icon on the Windows desktop.

The Workflow Configuration tool appears.

### Configure the Keyframe All workflow definition

For the Keyframe All workflow definition, you should set: the frequency with which the Workflow Service repeats the defined workflow process; also, the limits of the period within which it can run the process.

If you want keyframes to be generated for just a particular group of video clips (rather than all video clips), you need to add search criteria that enables the service to find the required clips.

1. Select the Media Rules tab in the Workflow Configuration window.
2. Select **Keyframe All** in the Media Rules list.  
The window displays details of the workflow definition.
3. Do the following if you want the workflow process to apply only to video clips that meet certain criteria.
  - Click  to the right of the **Criteria** box to open the PinPoint dialog.



- Specify search criteria to enable the Workflow Service to find the assets you want it to perform jobs for.
  - Close the PinPoint dialog.
4. Do the following in the Schedule Pattern section of the window.
    - Specify how often the Workflow Service should repeat the workflow process.
    - Specify the start and end of the period within which the Workflow Service is allowed to run the process.
  5. Click **Save**.

## Configure the Proxy All workflow definition

For the Proxy All workflow definition, you should set: the frequency with which the Workflow Service repeats the defined workflow process; also, the limits of the period within which it can run the process.

If you want proxy files to be generated for just a particular group of video clips (rather than all video clips), you need to add search criteria that enables the service to find the required clips.

1. Select the Media Rules tab in the Workflow Configuration window.
2. Select **Proxy All** in the Media Rules list.

The window displays details of the workflow definition.
3. Do the following if you want the workflow process to apply only to video clips that meet certain criteria.
  - Click  to the right of the **Criteria** box to open the PinPoint dialog.
  - Specify search criteria to enable the Workflow Service to find the assets you want it to perform jobs for.
  - Close the PinPoint dialog.
4. Do the following in the Schedule Pattern section of the window.
  - Specify how often the Workflow Service should repeat the workflow process.
  - Specify the start and end of the period within which the Workflow Service is allowed to run the process.
5. Click **Save**.

## Configure the Media Flow Export Asset workflow definition

For the Export Asset workflow definition, you specify the destination(s) for exported assets. To do this, you need to be familiar with XML tags.

1. Select the Complex tab in the Workflow Configuration window.
2. Select **Export Asset** in the Complex Workflows list.

The Workflow Configuration window displays details of the workflow definition. These include an example destination entry (in an XML element) in the **Additional Config** box.

3. Replace the values for the Name and URI attributes in the example destination entry with the details of a destination you want the Workflow Service to export assets to. Add entries for other destinations if you want to.
4. Click **Save**.

## Restart the Workflow Service

After you configure workflow definitions, the Workflow Service needs to be restarted.

1. Close the Workflow Service window and wait for the Server Controller to restart the service.

You can view, but not change, workflow-definition details under the Configuration tab of the Workflow Service window.

## Configuring the File Copy Service

The first time it starts, the File Copy Service displays its Configuration dialog:

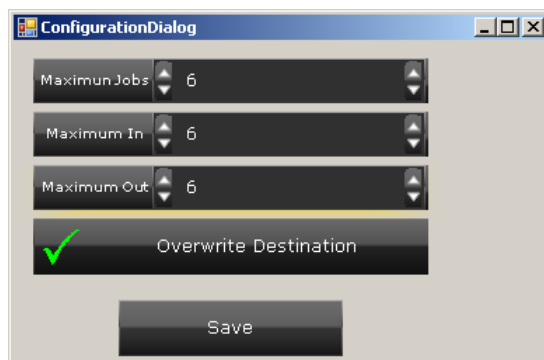

The service can perform multiple jobs simultaneously. You need to limit this number to prevent the service trying to use too much network bandwidth.

### Configure the File Copy Service on start-up

1. Enter values for the maximum number of simultaneous jobs the File Copy Service should attempt at any one time.
  - Enter a value for import and export jobs combined in the **Maximum Jobs** box.
  - Enter a value for import jobs in the **Maximum In** box.
  - Enter a value for export jobs in the **Maximum Out** box.

2. Click **Save**.

The File Copy Service restarts (under the control of the Server Controller) and displays a standard iTX service window.

#### Note:

- If you want to later modify these settings, you can recall the Configuration dialog by selecting **File Copy Service Config** from the iTX 2.0 category in the Windows Start menu.

## Configuring the Proxy Generation Service

When selected as part of the Job Services install, the Proxy Generation Service Installation dialog box appears, allowing you to configure your Proxy media settings.

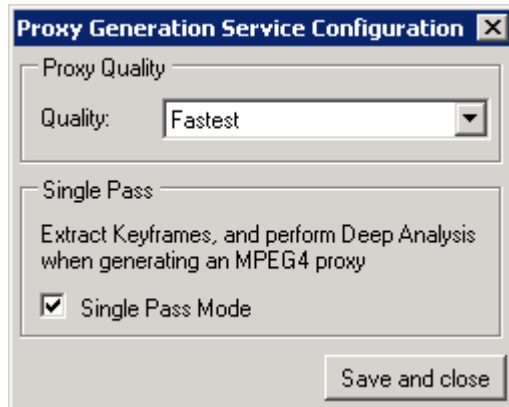

Here you configure the Quality of the of the browse media (Proxy Quality) and whether you require the Proxy Generation Service to automatically extract keyframes at the same time, while performing Deep Analysis of the video file (Single Pass).

### Proxy Quality

There are two options:

- **Highest:** files of this type contain more picture information but take longer to create.
- **Fastest:** files of this type take less time to create but contain less picture information.

### Single Pass

Selecting this option facilitates the creation of Keyframes at the same time as the mpeg4 browse media, but this will take longer to process the file on registration.

## Running the ITX Workflow services

On each machine on which you install ITX Workflow services, you start the services by starting the Server Controller. Each service displays information in a standard iTX service window.

You can view the Workflow Service job list on the Job Monitoring layout.

# Enabling iTX v2 to use the assets in an iTX v1 system

For iTX v2 to be able to use assets in an iTX v1 system, two extra services must run in the iTX v1.x domain.

- The OPUS 2 iTX Bridge Service.
- The Text Search Index Service.

You may install these on their own machine. Or you may install them on a machine in the iTX v2 system; in which case, we recommend you install them on the Database Server machine.

You must not, though, install the services on any machine in the iTX v1.x system; otherwise, the iTX Installer would modify the v1.x installation.

When you install the services, you configure them to operate in the v1.x system. You configure the iTX v2 system to link to the v1.x system.

## Identifying the iTX v1 domain

Locator Services in iTX v2 and iTX v1 systems enable the two systems to communicate with each other. For this to be possible, each Locator Service must have its domain name assigned to it.

For an iTX v2 system, this happens when you enter the domain and Locator Service details in the iTX Domain Configuration dialog during the installation of the Database Server module.

For an iTX v1 system, which is unlikely to be set up for multi-domain operations, you may need to enter a domain name in a Locator Service configuration file, DomainConfig.xml. You do this by using the Locator Service Configuration tool on the iTX v1 Database Server machine. [More details](#), page 49.

Enter a domain name in the **Domain Name** box and the address of the Locator Service in the **Primary Locator Uri** box:

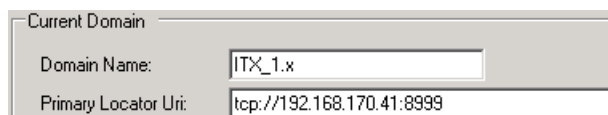

Current Domain	
Domain Name:	ITX_1.x
Primary Locator Uri:	tcp://192.168.170.41:8999

The Locator address requires the prefix “tcp://” and the port number 8999.

Check that the Locator Service window shows the domain name in the Service Info panel:

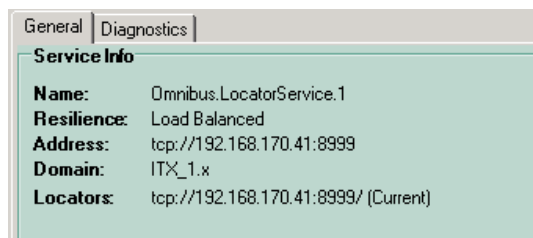

General   Diagnostics	
<b>Service Info</b>	
<b>Name:</b>	Omnibus.LocatorService.1
<b>Resilience:</b>	Load Balanced
<b>Address:</b>	tcp://192.168.170.41:8999
<b>Domain:</b>	ITX_1.x
<b>Locators:</b>	tcp://192.168.170.41:8999/ (Current)

You may need to restart the Locator Service.

## Installing the iTX software module

The required services are contained in the Migration From iTX 1.x software module, which is in the External Interfaces category of the iTX Installer.

If your iTX v2 system does not have a Locator Service (it may be using the Discovery communications model), you should install one on the Database Server machine.

### iTX v2 Locator Service configuration

1. Ensure there is a Locator Service installed in the iTX v2 system.
2. Use the Locator Service Configuration tool to add the details of the iTX v1 domain to the configuration file, DomainConfig.xml. [More details](#), page 49.

### Install the migration services

1. Double-click **Setup.exe** in the installation folder, iTX Suite, to start the installer.

The installer displays the iTX Installer dialog.

2. Click **Select Software** to open the Select Software to Install dialog.
3. Expand the External Interfaces category and select **Migration From iTX 1.x**.  
Click **OK** to close the Select Software to Install dialog.

The iTX Installer dialog shows the components that you selected.

4. Click **Continue**.

The installer performs the installation. For some tasks, it displays a dialog requesting you to enter certain system details. We describe how to use these dialogs below.

The iTX Opus 2 Bridge Configuration dialog:



This dialog appears twice – first for the OPUS 2 iTX Bridge Service and then for the Text Search Index Service.

Enter the required details:

- The IP address of the machine in the iTX v1.x system on which the Locator Service is running; this is normally the Database Server machine.
- The name of the iTX v1.x domain.

The Add Tables To Database dialog:

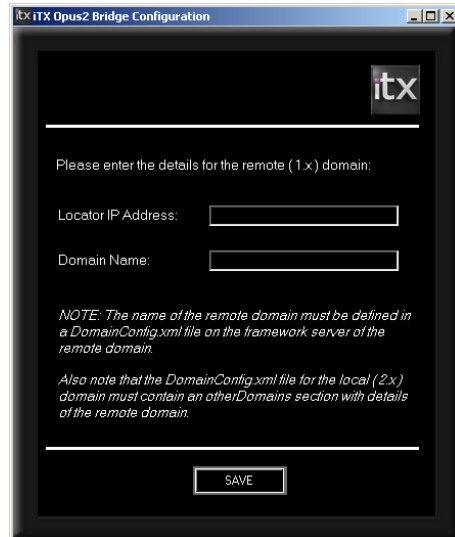

- In the **Database Server** box, enter the name of the Database Server machine in the iTX v1.x system.
- Ensure the entry in the **Database Name** box reads “Omnibus”.
- Select **Use Trusted Authentication**. Or enter the required database-access credentials in the **Username** and **Password** box.

The installer installs the selected components.

5. Click **Finish** to close the iTX Installer dialog.

## Configuring other services

To enable the iTX v1 and v2 systems to work together properly, small configuration changes are needed for other services in these systems. You need to:

- Edit the configuration file of the Media Data Service in the iTX v1 system.
- Modify the Media Watcher configuration in the iTX v2 system for multi-domain operation.

### Edit the Media Data Service configuration file

Do the following for the iTX v1 system.

1. For each Media Data Service, add the following entry in appSettings section of its configuration file, G3MediaDataService.exe.config.

```
<appSettings>
...
<add key="EnableMigrationEvents" value="Yes" />
...
</appSettings>
```

2. Restart the Media Data Service(s) and the OPUS 2 iTX Bridge Service.

## Set up the Media Watcher for multi-domain operation

Do the following for the iTX v2 system.

1. Under the Setup tab of the Media Watcher service window, add the Media folder in the iTX v1 system as a file store of the search type. [More details](#), page 80.

In setting the file store options, select **Search for Omnibus ' \_OMN' files**.

You may select **Copy media to central store** if you want the Media Watcher to copy media files from the iTX v1 system to the Media Store in the iTX v2 system and register them as assets in the iTX v2 system.

2. Under the Domains tab, add the iTX v1 domain to the central domain search list.
3. Save the configuration.

## Running the new services

Starting the Server Controller on the same machine starts the OPUS 2 iTX Bridge and Text Search Index Services.

The first time it runs, the Text Indexer Service creates an index of the assets in the iTX v1 system. The length of time this takes depends on the number of assets and the technical specification of the machine on which the service is running. On a low-specification machine with a high number of clips, this may take several hours.

## Checking the interaction of the two systems

1. At an iTX Desktop in the iTX v2 system, open PinPoint and search for an asset in the iTX v1 system.

You may need to refresh the domains list in the PinPoint dialog.

2. Check you can load the asset on the iTX Desktop.



# BXF Schedule Importing

BXF format schedules can be imported into iTX by using two standard workflows that are run by the Workflow Application Service. These two workflows facilitate the import of either file based or web service received BXF data.

**File Based Workflow** allows the Workflow Application Service to monitor a watch folder. When schedule files are placed in the folder, the workflow is triggered and the schedule file is processed. The schedule data is converted to the native iXML format and stored in the iTX database. The file is then moved to a processed folder at a specified location.

**Web Service Workflow** allows the Workflow Application Service to act as a web service that uses the REST protocol to process schedule data sent to it via the internet. As with the File Based Workflow, the schedule data received over the web is converted to the native iXML format and stored in the iTX database.

The conversion process supports most types of secondary items. For a comprehensive list please see the **Grass Valley iTX BXF Implementation Guide**.

## Installing the Workflow Application Service

1. Run the iTX Installer by double-clicking the **Setup.exe**. From the 'Select Software to Install' dialog expand the Workflow tree. Select **Workflow – BXF Traffic Processes** and **Workflow Application Service**.

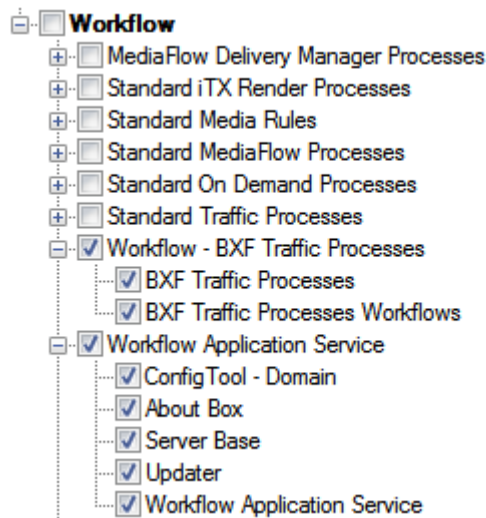

2. Click **OK**. Then on the main installation dialog click **Continue**. The Workflow Application Service, its configuration tool and the required Workflows will now be installed.

## Configuring the Workflow Application Service

To configure the Workflow Applications Service you must run the Workflow Application Service Configuration Tool.

1. Click Start > All Programs > iTX 2.0 > Workflow Application Service Config. This will run the tool.
2. A dialog box will appear prompting you to choose which configuration you wish to load and edit. If this is the first time you have configured the Workflow Applications Service, only **Default** will be listed. Make sure this is highlighted and click **OK**.

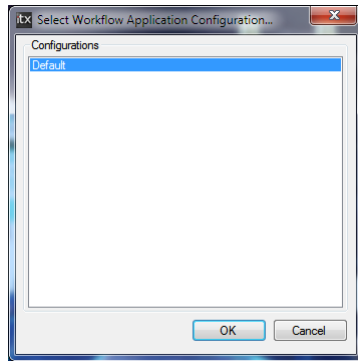

3. You will then be presented with the Add Workflow dialog pop-up. Click Add Workflow. A list of available Workflows appears. If this is the first time you have configured the Service, only two workflows will appear in the list; one for the file based workflow and one for the web based workflow.

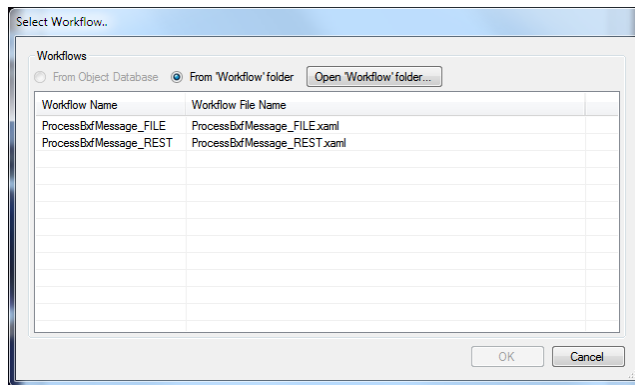

ProcessBxfMessage\_FILE.xml is the workflow for handling BXF Files.

ProcessBxfMessage\_REST.xml is the workflow for web processing.

Select the required type and click **OK**. This will load the specific workflow's configuration dialog.

## Configuring File Based Workflow

The file based workflow is configured using this Workflow Application Service Configuration dialog:

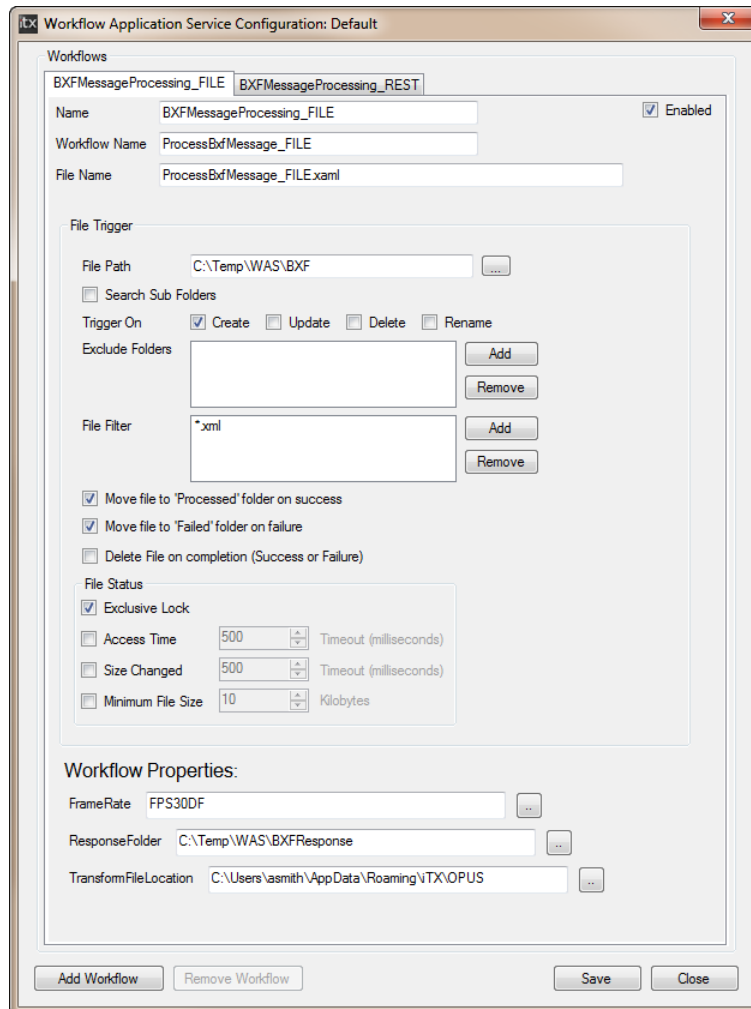

1. Name the configuration you are creating for this workflow, by typing it in the **Name** dialog window.
2. Make sure you select the **Enabled** checkbox on the right hand side; otherwise the workflow will not process anything.
3. File Path – type or navigate to the folder you want the workflow to watch. Select ‘Search Sub Folders’ if you require the Workflow to monitor for files that may appear in any folders inside the watched folder.
4. The **Trigger On** option determines what action triggers the workflow to take place. The default option is Create, which is when a file is created or added into the watch folder. The other three options are only relevant if you are choosing to not move or delete files after processing them.
5. **Exclude Folders** allows you to add the folder names for any within the watched folder that you do not wished scanned for new files.

6. **File Filter** allows you to list the file types you wish the Workflow to process. Type \*.xml and the Workflow will process any files that have xml in their extension names.
7. Check **Move file to 'Processed' folder on success** and **Move file to 'Failed' folder on failure** if you wish to transfer successfully and unsuccessfully processed files to these locations respectively. If you wish for neither of these options to take place then select **Delete File on completion (Success or Failure)**.
8. Check **File Status – Exclusive Lock** to prevent any other computer or software reading from or writing to the file once the Workflow Application Service has started to process the file.
9. If you wish to change any of the ftp related timeout settings such as **Access Time**, **Size Changed** or **Minimum File Size**, then checking these boxes will allow you to do so. However in most cases, the default settings should suffice.
10. Set the system frame rate via the **FrameRate** dialog. Supported formats are:
  - FPS30DF – NTSC Drop frame
  - FPS25 – PAL
11. **Response Folder** – BXF system responses to requests from Workflow Application Service are logged to this filepath. A typical example you might enter here is **C:\Temp\WAS\BXFResponse**
12. **Transform File Location** – this option is for use only with Dub and Purge Lists and is the URI to the xml style sheet file that defines transforming BXF data fields to Asset XML ones. By default, the transform file should be kept here:  
**C:\users\\*username\*\AppData\Roaming\iTX\Workflow App Service\Default\Transforms\BXFContent Transfer to AssettXml.xsl**

You can run the Workflow Application Service via the Server Controller now that the configuration settings are complete.

## Configuring the Web Service Workflow

The web service workflow is configured using this Workflow Application Service Configuration dialog:

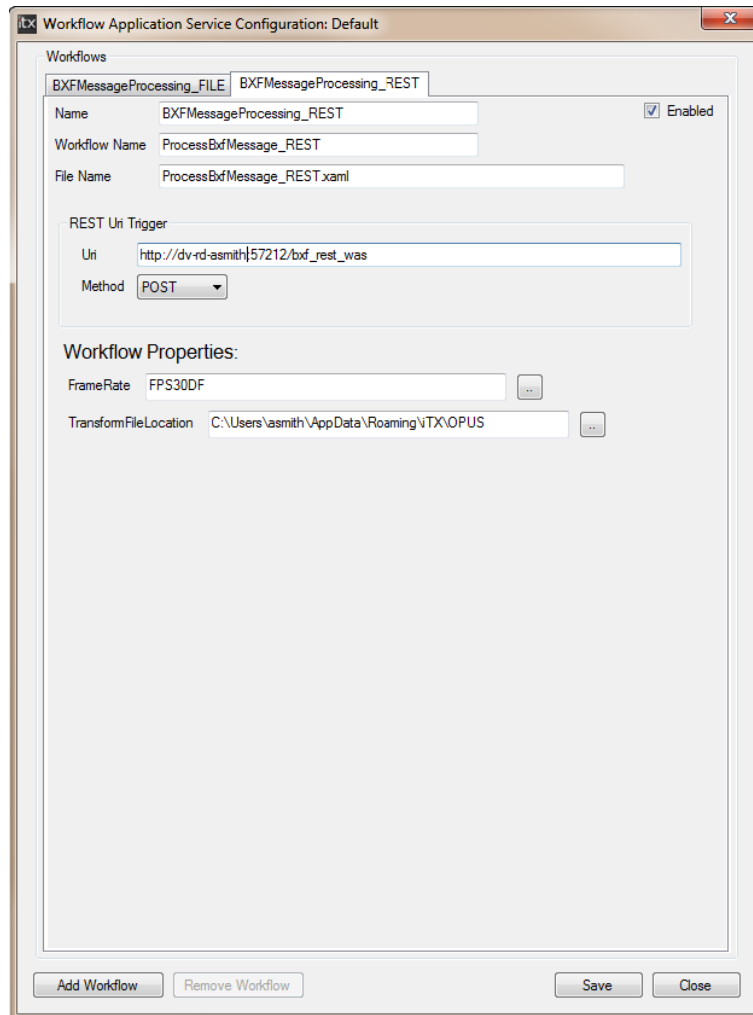

1. Name the configuration you are creating for this workflow, by typing it in the **Name** dialog window.
2. Make sure you select the **Enabled** checkbox on the right hand side; otherwise the workflow will not process anything.
3. **REST URI Trigger** – this dialog should contain the http path the web based data should be sent to.
4. **Method** –The default method for triggering the workflow here is ‘Post’. Leave this set as is.
5. Set the system frame rate via the **FrameRate** dialog. Supported formats are:
  - FPS30DF – NTSC Drop frame
  - FPS25 – PAL

6. **Transform File Location** – this option is for use only with Dub and Purge Lists and is the URI to the xml style sheet file that defines transforming BXF data fields to Asset XML ones. By default, the transform file should be kept here:

C:\Users\\*username\*\AppData\Roaming\iTX\OPUS

## Importing of Harris ADC100 schedules

Harris ADC100 playout schedules (with filenames of the form schedule\_name.lst) can be imported into iTX by using a workflow process that runs inside the Workflow Application Service.

This workflow process enables the Workflow Application Service to manage a file-based workflow:

- Harris ADC100 schedule files are placed in a watch folder.
- The Workflow Application Service processes the files, converting the schedule content into the iTXML-format schedules, which it stores in the System Database.
- The service moves the processed files to a Processed folder, if the processing is successful; or to a Failed folder, if not.

The workflow process currently supports these types of iTX event:

- Video Clip
- CG
- Logo
- Voiceover
- GPI
- Comment

## Setting up the Workflow Application Service for importing Harris ADC100 schedules

To make the schedule-importing functionality available, you need to run the iTX installer and install this component from the External Interfaces module: Schedule Processing Services – Harris ADC-100. You can do this on the machine on which the iTX Framework Services run. The installer installs the service and workflow-process definitions.

The first time you start the service, it displays a configuration dialog in which you need to set the properties for the workflow (pictured right).

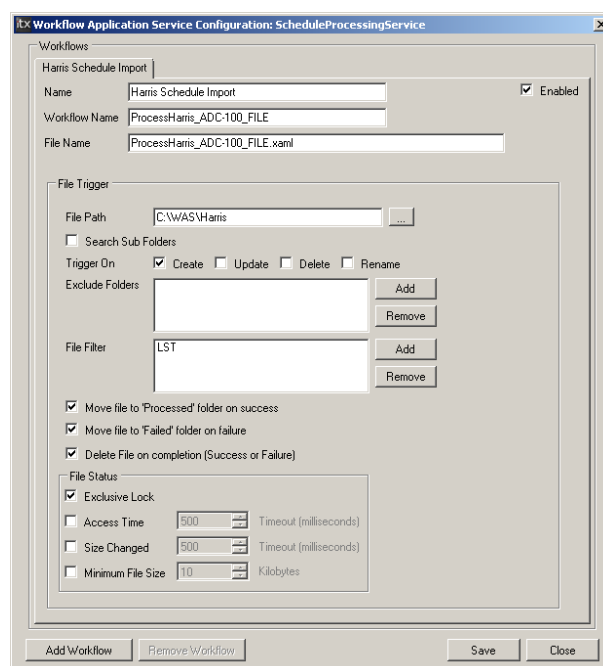

# BXF As Run Support

TX Play supports providing BXF based traffic systems with As Run data, via the iTX Metadata Database.

TX Play not only writes As Run information via the As Run Service to a log file, it also sends the same information to the Opus Service, which then writes the records to the iTX Metadata database. This then allows any third party BXF traffic system the ability to query that database at any convenient time in order to acquire the information dynamically.

This is done via the BXF Schedule Processing Service, the query can be over SOAP, REST or file based transport mechanisms.

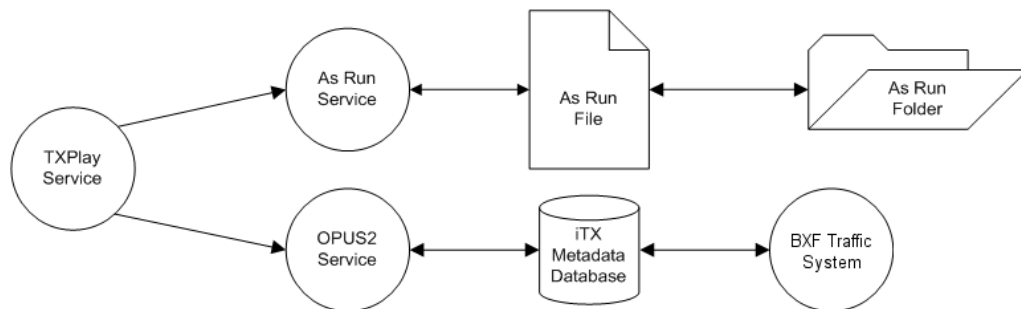

As Run schedules are stored based on the iTX channel name. So for an iTX channel named “A1” the As Run data is stored in a schedule named “A1\_AsRun”. If the schedule does not exist when As Run data is ready to be stored then a new schedule is created.

The iTX Metadata database is used to store extended data from ingested schedules. In the case of BXF, extended data is used to store the original BXF event for usage in the As Run records that are read back by the traffic system.

The As Run Service can still be configured to send As Run records to a web service if required, but the option is now configurable in the As Run service itself.



## HDSDI/SDI Preview from an iTX Desktop

An iTX Desktop workstation can output an HDSDI or SDI signal when playing back video clips. To provide this functionality, it needs to be fitted with an AJA Corvid LP video card.

Connecting the output signal to a video monitor makes it possible for an operator to watch broadcast-quality video images while playing back a video clip in the Media Viewer on the Asset layout. The audio content may be de-embedded and passed to an audio monitoring unit for playback.

The feature can be used in a QC checking of video and audio to give operators confidence in the quality of media that is to be available to iTX playout channels.

The feature requires v1.4 of the iTX media processor, which is called the File Processing Pipeline (or FPP for short). This delivers the video and audio streams to the Media Viewer and the Corvid LP video card at the same time:

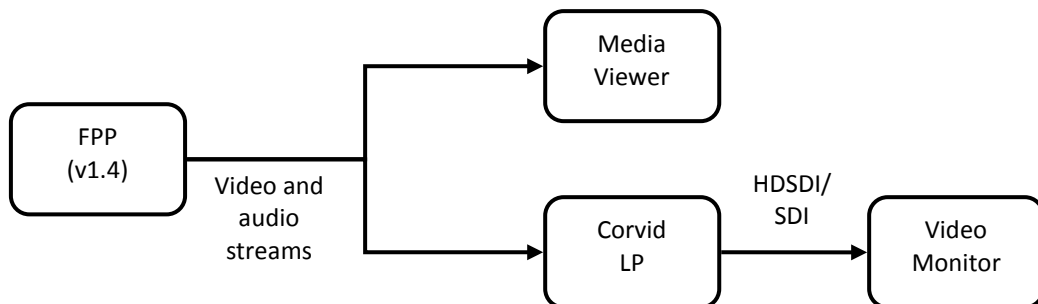

### Video playout

Playout on the video monitor is synchronized with playout in the Media Viewer for all the usual iTX Desktop playback controls:

- Play
- Pause
- Fast-forward
- Rewind
- Step forwards or backwards (frame by frame)

The video is displayed out at the aspect ratio defined in the media file; it is not scaled (which means anamorphic clips may appear squashed). Preview of SD and HD media encoded at any of the following display resolutions is supported: D1, 720p, 1080i.

### Audio playout

iTX handles audio content slightly differently depending on whether or not the Corvid LP card is in use: a Media Viewer option allows you to switch off the card output.

When the card is not in use, iTX plays back the audio content of a media file through the workstation speakers, as normal. It decodes any Dolby E streams that are selected for playback. The volume level can be adjusted through the volume slider on the Media Viewer.

When the card is in use, iTX plays back audio content through the workstation speakers but does not decode any Dolby E streams. The workstation volume is adjustable through the Media Viewer volume slider.

Identical audio content supplied to the card may be de-embedded from the output signal, decoded if necessary, and played back through dedicated speakers. Volume-level control is then independent of the Media Viewer; it is unaffected by the operation of the Media Viewer volume slider.

## Volume-level meters

The Media Viewer can optionally display volume-level meters for multiple audio tracks:



These show the volume level of the audio content that is played through the workstation speakers (reflecting operation of the volume slider) when the Corvid LP card is not in use. They show the levels of the various tracks in the media file when the Corvid card is in use.

## Installing the feature

To make the feature available, the Corvid LP video card needs to be inserted in the iTX Desktop workstation. Also, the required version of the FPP needs to be added to the iTX Desktop.

### Video card

The Corvid LP video card can be installed in a standard iTX Desktop workstation. For the technical specification of this workstation, contact Grass Valley Support.

For timing purposes, the card should be configured to “free run”: there should be no external reference signal or live feed connected to the card.

## FPP installation

The feature requires version 1.4 of the FPP. This is not available as an option in the automatic installation process controlled through the iTX installer. Instead, it is installed separately by running an executable, FilePipelineInstaller-1.4.exe:



The executable is stored in the ITX Install\PostInstall subfolder of the iTX Suite installation folder:

Right-click the executable and select **Run as administrator** from the displayed menu. The File Processing Pipeline Setup Wizard opens. Respond to the prompts in the wizard dialogs to perform the installation.

## Media Viewer options

For the feature to work, two options need to be selected in the Media Viewer menu:

For the Media Viewer operating mode, the option to use the FPP Viewer should be selected in the **Player Mode** box.

For the **SDI Output Device** setting, the video card reference number of '0' should be selected if there is only one HDSDI/SDI card in the workstation. (A different reference number may be selected if there is more than one card installed.)

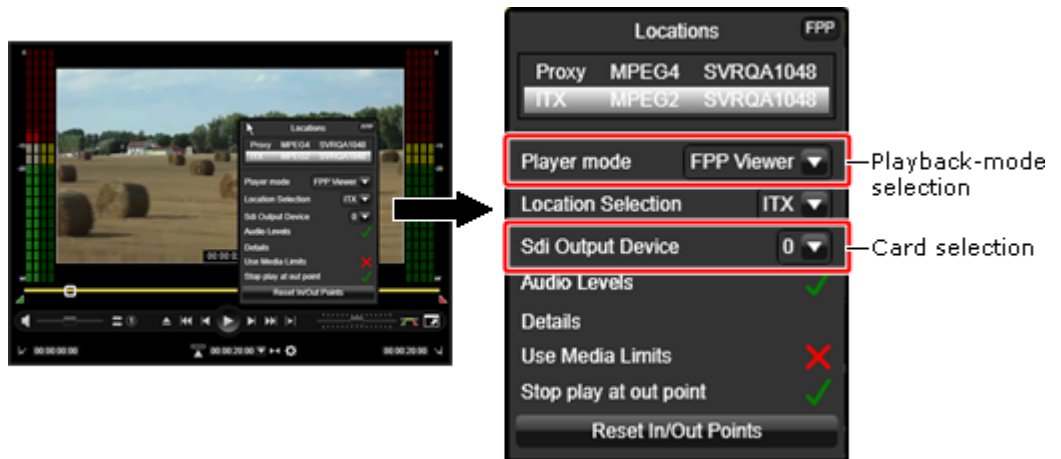

You can switch off the card output by selecting "None" for the SDI Output Device setting.

## Show/hide the volume-level meters

The volume-level meters are hidden when the Media Viewer first appears. To show the meters, right-click the Media Viewer and select **Audio Levels** from the displayed menu. Repeat this action when you want to hide the meters.

## Licensing

The feature is available with the standard iTX Desktop: no extra licensing is required.

## Not supported

The feature is not intended to be used for playout; it is designed for monitoring only.

It is not possible to play back 1080p media through the video card.

Any additional display content in a video clip (e.g. closed captions) is included in the output signal but not displayed.

No Dolby D or Dolby E data is decoded when the video card is in use.

It is not currently possible to control the Media Viewer through a hard panel or keyboard.

## Comparison of functionality

This table shows what media-playback functionality is available in the Media Viewer on the Asset layout.

Functionality under Media Viewer control	Desktop without Corvid LP card (Standard FPP)	Desktop with Corvid LP card	
		Desktop	External output
Display video at resolution:			
D1	✓	✓	✓
1080i	✓	✓	✓
720p	✓	✓	✓
1080p	x	x	x
Playback controls:			
Play	✓	✓	✓
Pause	✓	✓	✓
Fast-forward	✓	✓	✓
Rewind	✓	✓	✓
Jog	✓	✓	✓
Play back PCM audio	✓	✓	✓
Play back Dolby D audio	✓ (PCM stereo downmix)	x	x

Functionality under Media Viewer control	Desktop without Corvid LP card (Standard FPP)	Desktop with Corvid LP card	
		Desktop	External output
Play back Dolby E audio	x	x (✓ when the card output is switched off)	x
Display volume-level meter	✓	✓	✓
Allow audio-level adjustment	✓	✓	x
Scale video (e.g. anamorphic)	x	x	x
Hard-panel jog and shuttle	x	x	x

# Supporting Tools

## OPUS Metadata import tool for Core Systems

The iTX2 installer includes the OPUS Metadata tool, for importing metadata types and schemas into the iTX System Database from a Core system Colossus database.

Metadata types and schemas are used in the annotating of video clips and events in them.

The tool has the program name “Omnibus.OPUS.MetadataTool.exe”. You can find it in the Files sub-folder of the iTX Suite folder.

After opening the tool on the iTX Database Server machine, you configure it to connect to the Colossus database. Please note you will need to know the SQL connection details for the Colossus database in order to be able to do this.

On the Core Import tab click ‘Config’ and enter the following details for your Colossus database:

- Server Name
- Database
- User Name
- Password

From this, it gets details of available metadata types and displays a list of them under the Core Import tab:

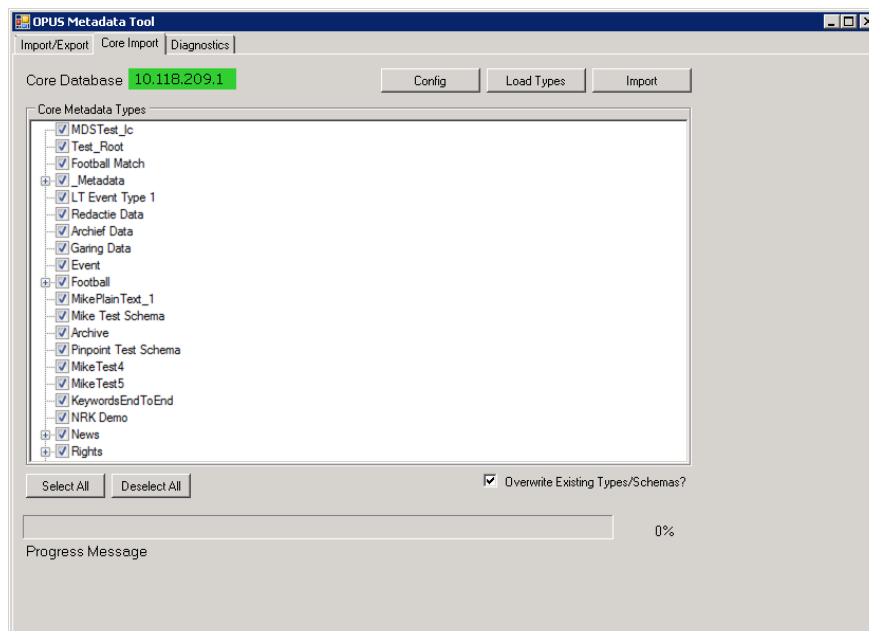

You can then select and import the metadata types that your iTX system requires. During this process the metadata schemas that are associated with the selected metadata types are also imported.

From the Import/Export tab, you can export metadata schemas in the iTX system as .xsd files for use by an external system.

## Updating Aspect Ratio information database location

### Note:

- The following section is only applicable to customers who are upgrading from iTX v2.4.9 or earlier to 2.4.10 or later for the first time and who use Aspect Ratio information contained within the clip assets.

As of iTX v2.4.10, when new assets are imported or ingested into the system, their Aspect Ratio information is written to a different location in the iTX database. The asset clip information for any media registered prior to iTX v2.4.10 must be transferred to the new location using a utility called Clip Fixer, which is included in the iTX Installer.

### Installing Clip Fixer

Clip Fixer can be installed and run on any computer that already has iTX Desktop installed.

#### To install the Clip Fixer application:

1. Run the iTX Installer and click **SELECT SOFTWARE**.
2. Scroll down to **Utilities** and expand the options tree.
3. Check the box marked **Clip Fixer**.
4. Click **OK**.
5. Complete the installation as normal.

### Setting the media format with Clip Fixer

You can set the media format to either 16x9 or 4x3, as such, if you have media in both formats you must run the operation twice for each type of clip.

#### To set the media format to either 16x9 or 4x3 with Clip Fixer:

1. Go to **Start > All Programs > iTX2.0 > Clip Fixer** to run the application.
2. From the left-hand column, check either the **Source Format 16x9** or **Source Format 4x3**.

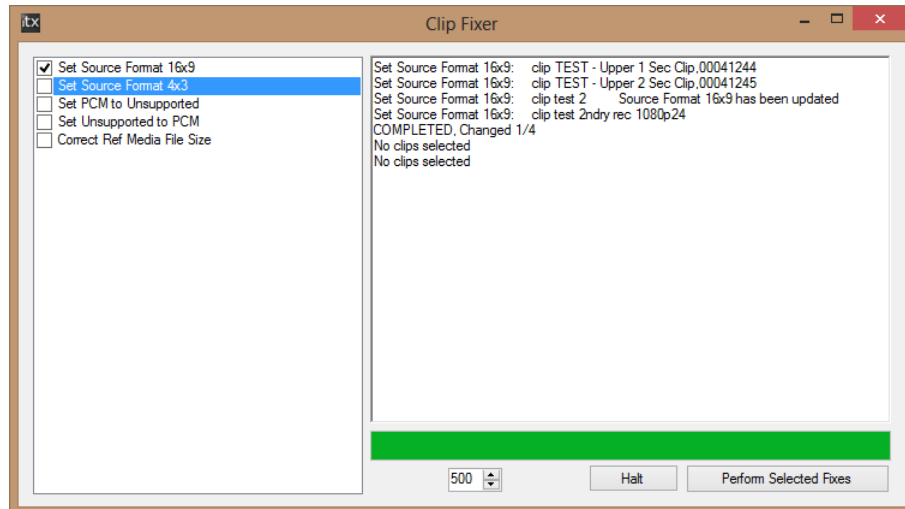

3. Click **Perform Selected Fixes**. A **PinPoint** search dialog appears.
4. Use **PinPoint** to select the clips you wish to update. Click **OK**.
5. The Clip Fixer automatically performs the operation on the batch of clips you have selected.
6. Repeat the process for the other format if necessary.

## About the TeleStream Vantage Job Service

The Vantage Job Service is a licensed module that allows iTX to interface with a TeleStream Vantage server to perform import, transcode and render jobs.

The iTX Vantage solution comprises of the following modules:

- **Vantage Job Service** - The Vantage Job Service is a bridge between iTX and the Vantage Server. It advertises new Vantage jobs to Opus, processes them and talks to the Vantage Server to create and monitor jobs.
- **Workflow Service and iTX Vantage workflows** – The iTX Vantage workflows are part of the Workflow Service. They are configured as simple workflows and can be initiated manually using iTX Desktop or SmartClient action buttons.

The Vantage Job Service uses the following Job Types:

- **Vantage Transcode** - This job takes an asset, runs a Vantage Transcode workflow and outputs the transcoded file.
- **Vantage Import** - This job type takes an asset with an external location and imports the media into the iTX media store, optionally performing Transcode jobs in the process.
- **Vantage Render** - This job type takes a shotlist asset (created in SmartClient) and renders it to a single media file. If the shotlist contains mixed formats or mixed resolution media, the Vantage Job Service will issue child Transcode jobs to normalize the source media.



## Prerequisites and definition of terms

This document uses the terms “Vantage Profile” or “Vantage Workflow”, which are the workflows installed on the Vantage Server. These are separate from iTX and should not be confused with iTX (Vantage) Workflows.

The following instructions assume the TeleStream Vantage system is already installed and configured with the required Vantage workflows.

For information on setting up and configuring a Vantage system, please refer to the Vantage user documentation provided by TeleStream.

## Installing the Vantage Job Service and workflows

The Vantage Job Service and workflows are part of the standard iTX Suite and require the Workflow Server to function.

In the iTX Installer check the following modules:

- **External Interfaces > Vantage Job Server**
- **Workflow > Workflow Server**
- **Workflow > Standard Vantage Processes**

For more information on installing iTX modules see “Installing iTX software modules” on page 27.

## Configuring the Vantage Job Service

On first installation, the Vantage Job Service Configuration appears, after which you can access this configuration dialog from:

All programs>iTX 2.0>Vantage Job Service Config.

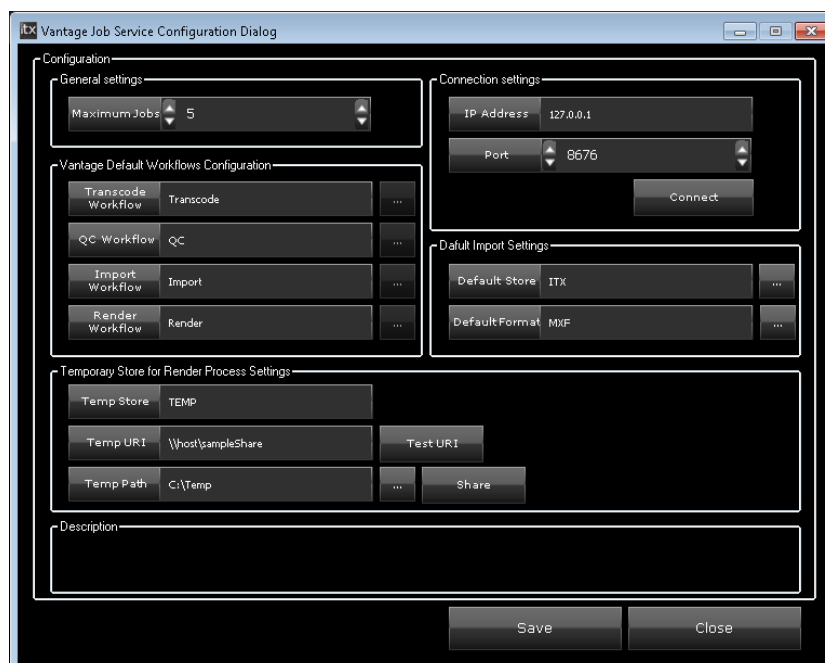

### To configure the Vantage Job Service:

1. In the **Maximum Jobs** field, enter the maximum number of concurrent jobs that this service will perform.  
  
If the application is running in Load Balanced mode (i.e. multiple instances running on different servers) each instance will be able to run this many jobs
2. In the **Connection settings** section, enter the following details:
  - **IP address** - enter the IP Address of the Telestream Vantage workflow Portal.
  - **Port** – enter the Port to connect to the Telestream Vantage workflow Portal (8676 by default).
3. Click **Connect** to test the IP address and Port number are valid and that you have access to the Vantage Server Host.  
  
If the test connection is successful, you will also be able to use the browse buttons in the **Vantage Default Workflows Configuration** section.
4. In the **Vantage Default Workflows Configuration** section will display the default workflows for each job type:
  - Transcode Workflow
  - Import Workflow
  - Render Workflow

If you have confirmed you connection to the Vantage Server Host using the Connect button, you will be able to select alternative Vantage workflows that are installed on your Vantage Job Server for each job type using the browse button.
5. In the **Default Import settings** section, select a value for the following options:
  - **Default Store** – When performing a Vantage Import Job, this setting indicates which media store the media should be imported to.
  - **Default Format** – When performing a Vantage Import Job, the media may be transcoded. Therefore the media format of the original file may not be the same as the format that is stored in the iTX Media store. This setting tells the Vantage Job provider what format the media will be transcoded to so that it can be delivered to the correct folder on the media store.
6. The settings in the **Temporary Store for Render Process Settings** section are used by the Render Process to normalize Shot marked from different media stored in different formats.  
  
Select a value for the following options:
  - **Temp Store** – When performing Vantage Render jobs using mixed formats/resolutions, the Vantage job service will need to normalize the media. The temp store is a temporary location that is added to the source clips that contains the normalized media.
  - **Temp Uri** – Enter the SMB URI path to the temporary store used to store normalized media. This is used to access the specified store.
  - **Temp Path** – This is the folder where the normalized media will be stored. This field is only used to create an SMB Share on the current host. The specified path is not sent to iTX.  
  
If you want to share a folder on the current host you can use the browse button to select an existing folder and then click the **Share** button. Shares created in this way point to the folder specified in the Temp Path field and named based on the contents of the Temp Store field.

The Temp Store and Temp URI values are used by the Vantage Job Service to create a Store in Opus with the Store name taken from the Temp Store field and the base path taken from the Temp URI field.

7. Click **Save** then **Close**.

## About Vantage and iTX Workflows

There are four iTX workflows, which can be used to map to counterpart Vantage workflows on the Vantage server:

- Vantage Import WF
- Vantage Render WF
- Vantage Transcode WF

These workflows can also be edited to overwrite the configuration in the Vantage Job Service Config, if required.

## Configuring iTX Vantage workflow properties

Each iTX Vantage Workflow contains a Workflow Property (or Properties) which can be used to overwrite the default values from the Vantage Job Service. If you want to use the settings configured in the iTX Vantage Job Service do not use or edit the Workflow Properties.

All Workflow Properties are empty by default. However if you want to overwrite some default values you can create another instance of the required iTX Vantage Workflow and put your values into those Workflow Properties.

### To configure the Workflow Properties for iTX Vantage workflows:

1. Open Workflow Configuration from Start>All Programs>iTX 2.0>Workflow Service Config.
2. Click the **Simple** tab.  
The **Simple Workflows** section lists the iTX Vantage workflows.
3. To configure Vantage Import WF properties:
  - a. Select Vantage Import WF and click **Properties**.

The **Workflow Properties Editor** appears with the following entries:

- VantageImportWorkflow
- TargetFormat
- DestinationStore
- SourceStore

- b. Double-click on an entry.

The **Edit Properties** dialog appears

- c. In the **Value** field for the selected entry, enter the required details as follows:

Entry Name	Value
VantageImportWorkflow	Enter the name of the Vantage import workflow for iTX, as it appears on the Vantage Workflow Designer..
TargetFormat	Enter the destination format of the media file (Optional)
DestinationStore	Enter the destination media store (Optional)
SourceStore	Enter the source location (Optional)

- d. Repeat steps b and c for each entry in the Workflow Properties Editor.
  - e. Click **OK** to close the **Edit Property** dialog.
  - f. Click **OK** to close the **Workflow Property Editor** dialog.
4. To configure Vantage Render WF properties:
    - a. Select Vantage Render WF and click **Properties**.  
 The **Workflow Properties Editor** appears.
    - b. Double-click on the VantageRenderWorkflow entry.  
 The **Edit Properties** dialog appears.
    - c. In the **Value** field, enter the name of the Vantage render workflow for iTX, as it appears on the Vantage Workflow Designer.
    - d. Click **OK** to close the **Edit Property** dialog.
    - e. Click **OK** to close the **Workflow Property Editor** dialog.
  5. To configure Vantage Transcode WF properties:
    - a. Select Vantage Transcode WF Properties and click **Properties**.  
 The **Workflow Properties Editor** appears.
    - b. Double-click on the VantageTranscodeWorkflow entry.  
 The **Edit Properties** dialog appears.
    - c. In the **Value** field, enter the name of the Vantage transcode workflow for iTX, as it appears on the Vantage Workflow Designer.
    - d. Click **OK** to close the **Edit Property** dialog.
    - e. Click **OK** to close the **Workflow Property Editor** dialog.
  6. Click **Save** and then close the Workflow Configuration dialog.
  7. Restart the Workflow Service.

## Custom Vantage Workflows

As well as the iTX Workflows, the Vantage Server has its own Workflows/Profiles. The iTX Vantage Job Provider uses Vantage Workflows read from its configuration file to start the Vantage Workflows.

Example workflows such as `iTX_Render (iTX_Render.xml)` are provided with the installer. If you wish to write your own custom Vantage Import workflow then the workflow will need to do the following things:

- **Move operation**

The workflow must contain a Move operation that sets the Destination filename

Set the Destination filename pattern to be bound to the variable `iTX.DestinationFilename`.

- **Deploy Operation**

The workflow must contain a Deploy operation to send the file to the correct folder on the iTX media store.

Select **Deploy>Export>Bindable filesystem**.

In the **Specify Variable Binding for destination folder** dialog, bind to the variable `iTX.DestinationPath`.

- **Transcode**

The Render workflow must contain an Encode operation.

## About Interra Baton QC Job Service

The Baton QC Job Service is a licensed module that uses iTX workflows to integrate with the Interra Baton Automated File-based QC Solution to analyse media assets for the purposes of quality control.

Baton uses different test plans for different video formats (for example MOV, MPEG, GXF, LXF, MXF SD and MXF HD) to determine what to analyze. These test plans are created outside of iTX and stored on the Baton server.

iTX workflows can then trigger the Baton test plans in the following ways:

- On media import, via a Delivery Manager post media import workflow.
- Manually, via a Manual Baton QC Action button on the Asset layout of iTX Desktop.
- Using media rules on ingest recording (or any other non-Delivery Manager methods of ingest). The default media rule is called Baton QC All and covers all video files.

When the media analysis is complete, the results can be seen on the asset's Events tab and as reports attached to the Asset as PDF and XML files.

### Prerequisites

The Interra Baton QC system is independent of iTX. The following instructions assume the Interra Baton QC system is installed and configured with the required test plans.

For information on setting up the Baton system and creating test plans, please refer to the Baton user documentation provided by Interra.

## Installing the Baton QC Service and workflows

The Baton Job Service and workflows are part of the standard iTX Suite and require the Workflow Server to function.

In the iTX Installer check the following modules:

- **External Interfaces > Baton QC Service**
- **Workflow > Workflow Server**
- **Workflow > Standard Baton Processes**

For more information on installing iTX modules see “Installing iTX software modules” on page 27.

## Configuring the Job Service Manager for Baton QC

The Baton QC Job Service is configured using the standard iTX Job Service Manager.

### To Configure the Baton QC Service:

1. Open the **Baton QC Service Config** from Start>All Programs>iTX 2.0>Baton QC Service Config.  
The **Job Service Manager Configuration: Baton QC** dialog appears.
2. The **Job Service Details** section contains the name and plugin for the Baton QC Job Service and should not be changed.
3. In the **Concurrency Details** section, set the following values as required:
  - **Group Name** – Select a job group in which to run concurrent Baton QC jobs.
  - **Max** – Use the drop down list to select how to limit the maximum number of concurrent jobs for the selected group. The options are:
    - Not Set
    - Maximum Jobs
    - Maximum CPUs

If you select **Maximum Jobs** or **Maximum CPUs**, you must also set a numeric value. A value of 0 means unlimited.
4. In the **Configuration** section, enter the following details for the Baton server:
  - **IP Address**
  - **Port**
  - **Username**
  - **Password**
5. Click **Test connection** to confirm you have the correction details and credentials, and have access to the Baton server.
6. The **Baton Report Labels** section contains the label names for the Baton analysis PDF and XML files and should not be changed.
7. Click **Save** and then **Close**.

## Configuring Baton QC Workflows

After the Baton QC Service has been installed, the iTX workflows and media rules need to be configured to execute the required test plans and Delivery Manager needs to be told which post media workflow to use.

## Configuring Baton QC Media Rule Properties

The Baton QC All media rule is used to trigger Baton QC jobs on non-Delivery Manager ingests. So that this media rule knows which Baton test plans to execute for each video format, you must define them within its Properties.

### To configure the Properties for the Baton QC All media rule:

1. Open Workflow Configuration from Start>All Programs>iTX 2.0>Workflow Service Config.
2. Click the **Media Rules** tab.
3. From the **Media Rules** list, select Baton QC All.
4. Click **Properties**.

The **Workflow Properties Editor** appears. By default, the **Name** column is populated with the supported video formats. These values are hardcoded and cannot be changed. The **Value** column contains placeholder names for the Baton test plans to execute against each video format.

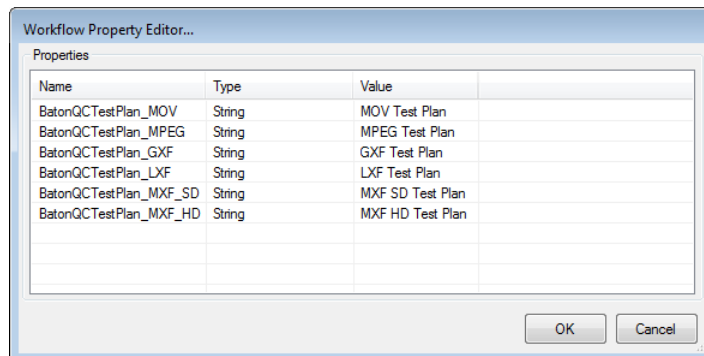

5. Double-click on an entry for the video format you want to edit (e.g. BatonQCTestPlan\_MPEG).

The **Edit Properties** dialog appears.

6. In the **Value** field, enter the name of the Baton test plan to execute for that video format. This must match the name of the test plan, as listed in the **Test Plan** tab of the Baton **Planner** page.
7. Click **OK**.  
The Edit Property dialog closes.
8. Repeat steps 5 to 7 for each video format for which you have a Baton test plan.
9. Click **OK**.  
The Workflow Property Editor dialog closes.
10. Click **Save**, then close the Workflow Configuration dialog.
11. Restart the Workflow Service

## Configuring Manual Baton QC Workflow Properties

The Manual Baton QC workflow is used to trigger Baton QC jobs from an Action button on the Asset layout. So that this workflow knows which Baton test plans to execute for each video format, you must define them within its Workflow Properties.

**To configure the Workflow Properties for the Manual Baton QC workflow:**

1. Open Workflow Configuration from Start>All Programs>iTX 2.0>Workflow Service Config.
2. Click the **Simple** tab.
3. From the **Simple Workflows** list, select Manual Baton QC.
4. Click **Properties**.

The **Workflow Properties Editor** appears. By default, the **Name** column is populated with the supported video formats. These values are hardcoded and cannot be changed. The **Value** column contains placeholder names for the Baton test plans to execute against each video format.

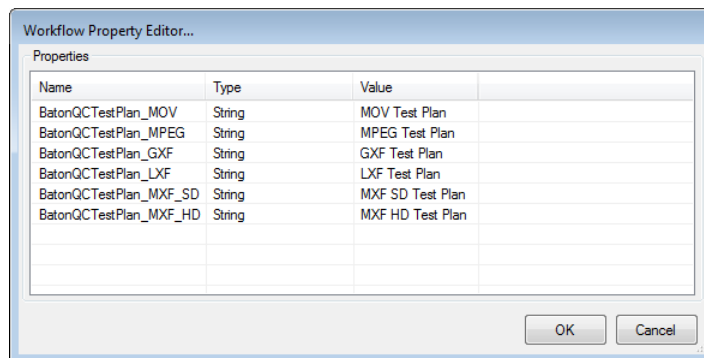

5. Double-click on an entry for the video format you want to edit (e.g. BatonQCTestPlan\_MPEG).

The **Edit Properties** dialog appears.

6. In the **Value** field, enter the name of the Baton test plan to execute for that video format. This must match the name of the test plan, as listed in the **Test Plan** tab of the Baton **Planner** page.
  7. Click **OK**.
- The Edit Property dialog closes.

8. Repeat steps 5 to 7 for each video format for which you have a Baton test plan.
9. Click **OK**.

The Workflow Property Editor dialog closes.

10. Click **Save** then close the Workflow Configuration dialog.
11. Restart the Workflow Service

## Configuring the Delivery Manager Post Media Import Workflow

For Delivery Manager imports, the endpoints need to be configured to use the Baton QC Post Media Import Workflow. Unlike the Manual Baton QC workflow, the properties for the Baton QC Post Media Import Workflow are blank by default. This is because Delivery Manager workflows share properties.



**To configure a Delivery Manager Post Media Import Workflow:**

1. Open the Delivery Manager Config from Start>All Programs>iTX 2.0>Delivery Manager Config.

The **Select Configuration** dialog appears.

2. Select an endpoint configuration to update and click **OK**.

The endpoint configuration dialog appears.

3. Click the **Post Media Import Workflow** browse button.

The **'Post Media Import' Workflow** dialog appears.

4. Select `DefaultPostMediaImportWithBatonQC` and click **OK**.

5. Click **Workflow Properties**.

A blank **Workflow Property Editor** dialog appears.

6. Right-click anywhere on the **Workflow Property Editor** and select **Add Property**.

7. The **Add New Property** dialog appears.

8. Enter one of the following properties as required:

Name	Type	Value
BatonQCTestPlan_MOV	String	Enter the name of the Baton test plan to execute for MOV videos.
BatonQCTestPlan_MPEG	String	Enter the name of the Baton test plan to execute for MPEG videos.
BatonQCTestPlan_GXF	String	Enter the name of the Baton test plan to execute for GXF videos.
BatonQCTestPlan_LXF	String	Enter the name of the Baton test plan to execute for LXF videos.
BatonQCTestPlan_MXF_SD	String	Enter the name of the Baton test plan to execute for SD MXF videos.
BatonQCTestPlan_MXF_HD	String	Enter the name of the Baton test plan to execute for HD MXF videos.

The test plan names you enter into the **Value** field must match the name of the test plan, as listed in the **Test Plan** tab of the Baton **Planner** page.

9. Repeat steps 6 to 8 for each video format for which you have a Baton test plan.
10. On the endpoint configuration dialog, click **Save**, then **Close**.
11. Restart the Delivery Manager service for the changes to be applied.



## Grass Valley Technical Support

For technical assistance, contact our international support center on:

1-800-547-8949 (US and Canada) or +1 530 478 4148.

To obtain a local phone number for the support center nearest you, please consult the Product Support section of Grass Valley's website ([www.grassvalley.com](http://www.grassvalley.com))

An online form for e-mail contact is also available from the website.

## Corporate Head Office

Grass Valley  
3499 Douglas-B.-Floreani  
St-Laurent, Quebec H4S 2C6  
Canada  
Telephone: +1 514 333 1772  
Fax: +1 514 333 9828

[www.grassvalley.com](http://www.grassvalley.com)