



DV-Bridge+

Guide to Installation
and Operation
M463-9900-202

*Copyright 2004
Miranda Technologies Inc.
Specifications may be subject to change.
Printed in Canada
March 2004*



**Miranda
Technologies inc.**
3499 Douglas B. Floreani
St-Laurent, Québec, Canada H4S 1Y6
Tel. 514-333-1772
Fax. 514-333-9828
www.miranda.com

DV To/From
Digital
Audio-Video
Codec

DV-Bridge+

Warranty Policies

Warranty Statement

Miranda Technologies Inc. warrants that the equipment it manufactures shall be free from defects in material and workmanship for a period of two (2) years from the date of shipment from the factory. If equipment fails due to such defects, Miranda Technologies Inc. will, at its option, repair or provide a replacement for the defective part or product. Equipment that fails after the warranty period, has been operated or installed in a manner other than that specified by Miranda, or has been subjected to abuse or modification, will be repaired for time and material charges at the Buyer's expense.

All out-of-warranty repairs are warranted for a period of ninety (90) days from the date of shipment from the factory.

Miranda Technologies Inc. makes no other warranties, expressed or implied, of merchantability, fitness for a particular purpose or otherwise. Miranda's liability for any cause, including breach of contract, breach of warranty, or negligence, with respect to products sold by it, is limited to repair or replacement by Miranda, at its sole discretion. In no event shall Miranda Technologies Inc. be liable for any incidental or consequential damages, including loss of profits.

Effective January 1, 2002

Warranty Exchange Policies

Miranda Technologies Inc. warrants that the equipment it manufactures shall be free from defects in materials and workmanship for a period of two (2) years from the date of shipment from the factory. If equipment fails due to such defects, Miranda will provide repair of the failed unit under the terms of the Miranda warranty.

If the equipment has been proven to be defective on arrival, Miranda will ship a new product in exchange, usually within 36 hours of factory notification.

If the equipment to be repaired is essential and the customer so requests, Miranda will, at its option, provide a service replacement or loaner part or product, usually within 36 hours of factory notification, weekends and holidays excluded.

All warranty exchange or loaner parts or products shall be shipped to the Buyer with a packing list clearly describing the items and stating the date of shipment. Repaired parts or products will be shipped to the Buyer with a

GUIDE TO INSTALLATION AND OPERATION

similar packing list. In the case of exchange, the defective products or parts must be returned to Miranda within fifteen (15) days from receipt by the customer of the exchange product. In the case of a loaner, the loaned products or parts must be returned to Miranda within fifteen (15) days from receipt by the customer of the repaired equipment.

If the equipment is not returned within fifteen (15) days, as described for either exchanges or loans, A Rental Invoice will be generated. Rental terms will be fifteen (15) percent of the current list price of the products or parts per month or a fraction thereof. Before returning the equipment to Miranda Technologies Inc., for any reason, the Buyer must first obtain a Return Authorization Number from Miranda Technologies Inc. Miranda Technologies Inc will pay freight and insurance charges for the delivery of the loaner or exchange products or parts. Freight and insurance charges for the return of the defective product or part will also be paid by Miranda Technologies.

Out-Of-Warranty Repair Policy

Miranda will repair equipment which is out of Warranty. The current pricing structure for this service is available from the Miranda web site at www.miranda.com or from Miranda Technical Support Services at (514) 333-1772. All out-of-warranty repairs are warranted for a period of 90 days from the date of shipment from the factory. Before returning the equipment to Miranda Technologies Inc., for any reason, the Buyer must first obtain a Return Authorization Number from Miranda Technologies Inc. In the case of a product deemed by Miranda to be beyond repair, the customer must purchase a new product at current retail prices.

The Buyer will pay freight and insurance charges for the return of the defective product or part to the manufacturer for repair. Miranda Technologies will pay freight and insurance charges for the return of the repaired product or part to the Buyer.

Out-Of Warranty Equipment Updates and Spare Parts Policy

Miranda Technologies' current pricing structure for out-of-warranty equipment updates, or the sale of spare parts, is available from Miranda Technical Support Services at (514) 333-1772.

Safety Compliance Information

Safety Compliance

This equipment complies with:

- CAN/CSA C22.2 No. 950-95 / Safety of Information Technology Equipment, Including Electrical Business Equipment.
- UL Std. No. 1950, 3rd Ed. / Safety of Information Technology Equipment, Including Electrical Business Equipment.
- EN 60950:1992 (2nd edition) Incorporating A1, A2, A3, A4, and A11/ Safety of Information Technology Equipment, Including Electrical Business Equipment.

CAUTION

These servicing instructions are for use by qualified service personnel only. To reduce the risk of electric shock, do not perform any servicing other than that contained in the operating instructions unless you are qualified to do so. Refer all servicing to qualified service personnel.

Electromagnetic Compatibility

- This equipment has been tested for verification of compliance with FCC Part 15, Subpart B, class A requirements for Digital Devices.
- This equipment complies with the requirements of:
EN 55022 Class A, Electromagnetic Emissions,
EN 61000-3-2 & -3-3, Disturbance in Supply Systems
EN 61000-4-2, -3, -4, -5, -6, -8 & -11 Electromagnetic Immunity
EN 55024 Electromagnetic Immunity

GUIDE TO INSTALLATION AND OPERATION

How to contact us:

Head Office

Miranda Technologies Inc.
3499 Douglas-B.-Floreani
St. Laurent (Montreal), Que. H4S 1Y6
Canada

Tel +1 (514) 333-1772
Fax +1 (514) 333-6914
Toll free: 1-800-224-9828

Miranda Europe

216 Rue De Rosny
93100 Montreuil
France

+33 1 55 86 87 88
+33 1 55 86 00 29

www.miranda.com

Miranda Asia

Mita Nexus Bldg. 2F
1-3-33 Mita, Minato-Ku
Tokyo, Japan 108-0073

+81 3 5730 2988
+81 3 5730 2973

GUIDE TO INSTALLATION AND OPERATION

Contents

	page
1 DV-Bridge+ DV To/From Digital Audio-Video Codec	1
1.1 Introduction	1
1.2 Features.....	2
2 Installation.....	3
2.1 Connections	3
2.2 Application Examples.....	4
3 Operation	7
3.1 Front PanelUser Interface	7
3.2 DIP Switches on Bottom Panel.....	8
3.3 Device Control.....	11
4 Troubleshooting	13
5 Specifications	15

GUIDE TO INSTALLATION AND OPERATION

1 DV-Bridge+ DV To/From Digital Audio-Video Codec

1.1 Introduction

DV-Bridge+ is a compact, desktop unit designed to convert 4:2:2 (ITU-601) video and AES-3id audio to and from DV compressed audio/video. The DV-Bridge+ is ideal for interfacing consumer or professional miniDV camcorders, VTRs, and editing or graphics systems equipped with the IEEE-1394 (FireWire, i.LINK) interface to professional uncompressed (4:2:2 and AES-3id) video and audio equipment. DV-Bridge+ acts as either a DV encoder or decoder. When operating in encode mode, DV-Bridge+ encodes material originating in 4:2:2 and AES-3id to the DV format and outputs DV on the IEEE-1394 interface. As a decoder, DV-Bridge+ decodes material arriving on the same IEEE-1394 interface and converts it to 4:2:2 and AES-3id. Convenient NTSC/PAL, S-Video and line-level analog audio outputs allow simple monitoring or dubbing of the DV signal. DV-Bridge+ is ideal for a number of recording, dubbing and monitoring applications in a mixed DV/4:2:2 and AES-3id environment.



DV-Bridge+ also provides time code support (LTC, DVITC) and remote-control capabilities through the IEEE-1394 ports and through a RS-422 serial port. The DV-Bridge+ features a simple user interface, using a single button to control its functions and bi-color monitoring LEDs. Some parameters are set using DIP switches on the bottom of the unit. Input and output connectors are in the back, as is the power switch. The DV-Bridge+ features a universal power supply, eliminating the

GUIDE TO INSTALLATION AND OPERATION

need for a separate power converter. A built-in anti-slip camera rest allows a DV camera to sit conveniently in view to monitor its operation.

Figure 1 Functional Block Diagram

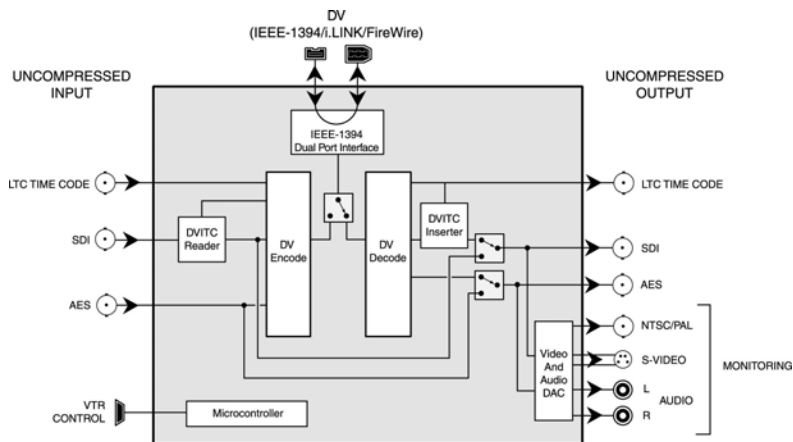

1.2 Features

- Bi-directional DV to SDI/AES converter
- Designed for DV devices equipped with IEEE-1394 interface (a.k.a. i.LINK, Firewire)
- Encodes 4:2:2 video and AES-3id audio to DV stream
- Decodes DV stream to 4:2:2 (SDI) video and AES-3id audio
- Dual IEEE-1394 ports
- AES-3id audio input and output for interconnection with professional audio equipment
- Convenient NTSC/PAL, S-Video and analog audio outputs for monitoring and dubbing
- Automatic detection of 525/625 line/scan formats
- Support of 32, 44.1 and 48 kHz audio sample rates
- Fully compatible with existing software and hardware for DV/i.Link processing
- Compact package suitable for desktop
- Built-in, universal power supply
- LTC and DVITC time code support in input and output with OSD (On-Screen Display) capability
- Remote-control using IEEE-1394 (e.g. a DV VTR) or through the RS-422 serial port (compatible with basic commands of the Sony BVW-75 protocol)

2 Installation

2.1 Connections

Refer to figure 2.1 and to the following description when connecting the DV-Bridge+.

Figure 2.1 Rear view of the DV-Bridge+

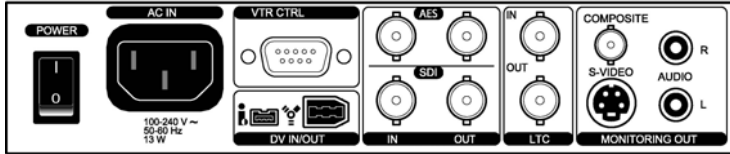

1 DV In/Out

Connect a DV source to one of the DV connectors at the rear of the DV-Bridge+ for input and output. Source must comply with IEEE-1394 (i.Link) standard. The 4-pin and 6-pin connectors effectively provide active loop-through when the unit is turned on.

2 SDI In/Out

Connect an SDI signal to the SDI input BNC connector (left-hand side) labeled SDI. The DV-Bridge+ accepts 4:2:2 serial digital video signals in either 525 or 625 line formats. The input signal must conform to the SMPTE 259M standard. For DVITC timecode support, insert a timecode conforming to SMPTE 12M in the input signal. Connect destination equipment to the SDI output BNC connector (right-hand side). The DVITC timecode in the output signal respects the same standard as the one in the input signal.

3 AES In/Out

Connect an unbalanced AES signal to the AES input BNC connector labeled AES. The DV-Bridge+ supports 32, 44.1 and 48 kHz sample rates. This signal must comply with the AES-3id-1995 (SMPTE 276M) standard. Connect destination equipment to the AES output BNC connector (right-hand side).

4 LTC In/Out

Connect an LTC signal to the LTC input BNC connector labeled LTC (upper one). The DV-Bridge+ accepts LTC signals for 525 or 625 line formats. This signal must comply with the SMPTE 12M standard. Connect destination equipment to the LTC output BNC connector (lower one).

5 Monitoring Output

GUIDE TO INSTALLATION AND OPERATION

Connect analog destination equipment to the connectors at the rear of the DV-Bridge+. Use the BNC labeled Composite or the mini-Din labeled S-Video for video output; use the two RCA labeled R and L for audio output.

6 AC In

Connect the supplied AC power cord into AC inlet. Both 120 VAC and 220 VAC standards are supported by the DV-Bridge+ built-in power supply.

2.2 Application Examples

The following figures show typical set-ups for using the DV-Bridge+.

Editing video and audio where the editing workstation operates in either DV or 4:2:2 while the video source/destination is in the other is illustrated in figures 2.2 and 2.3. Transferring video and audio from one format to the other is illustrated in figures 2.4 and 2.5. Dubbing from a DV source to a consumer VTR is shown in figure 2.6, while figure 2.7 shows how to monitor a DV-to-DV dubbing session.

Figure 2.2 Editing with a DV Workstation and a 4:2:2 VTR

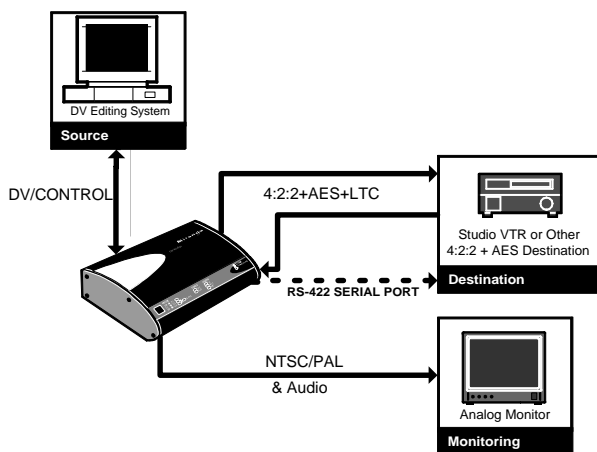

The RS-422 DIP switch is set to Controlling. IEEE-1394 device control from the workstation is transferred to the VTR via RS-422 Sony protocol.

Figure 2.3 Editing with a 4:2:2 Workstation and a DV VTR

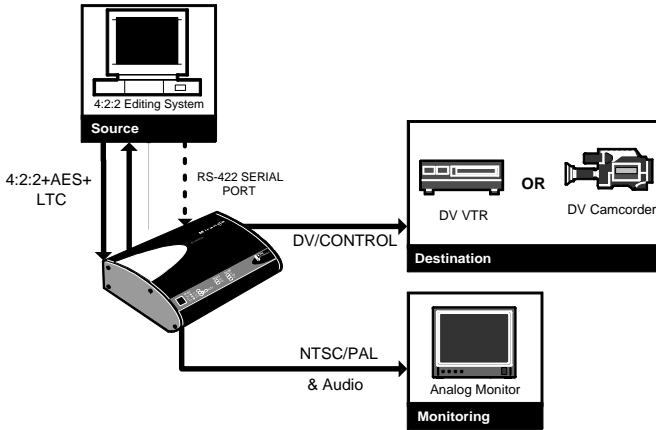

The RS-422 DIP switch is set to *Tributary*. RS-422 device control from the workstation is transferred to the VTR via the IEEE-1394

NOTE : With Tributary option selected you must only connect **one** DV device to the DV-Bridge+; the second IEEE-1394 port must remain empty.

Figure 2.4 Transferring from DV to SDI+AES+LTC

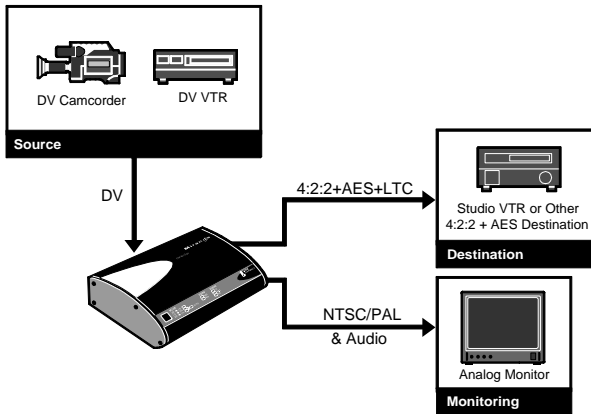

GUIDE TO INSTALLATION AND OPERATION

Figure 2.5 Transferring from **SDI+AES+LTC** to **DV**

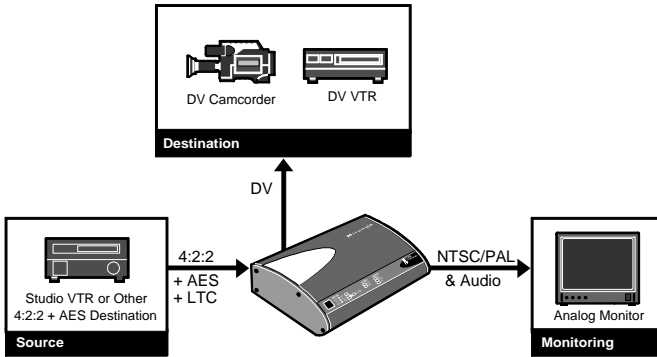

Figure 2.6 Dubbing from **DV** to **Consumer VCR** (VHS or S-VHS)

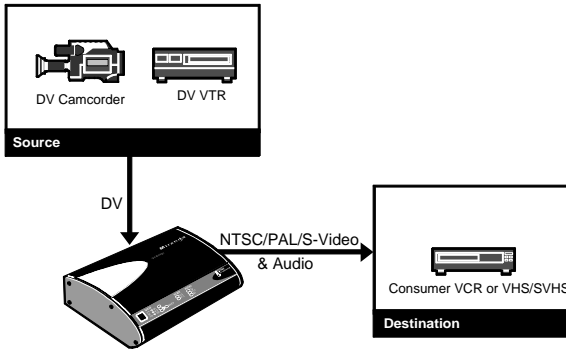
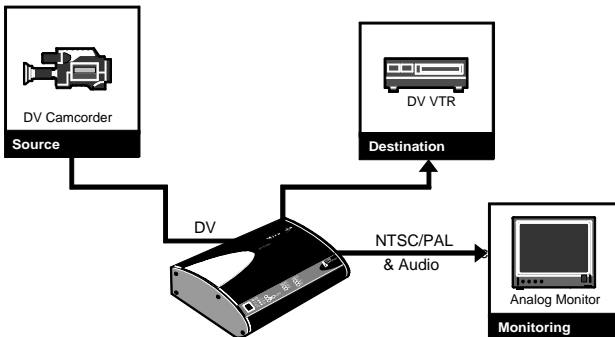

Figure 2.7 Monitoring a **DV** to **DV** transfer



3 Operation

Controls for the DV-Bridge+ are found on the front panel (see figure 3.1), and on the bottom of the unit (see figure 3.2).

3.1 Front Panel User Interface

Once the DV-Bridge+ is connected to the source and destination equipment, a single front-panel button is used to select the operating mode. Operating mode and signal status are monitored by LEDs.

Figure 3.1 Front panel

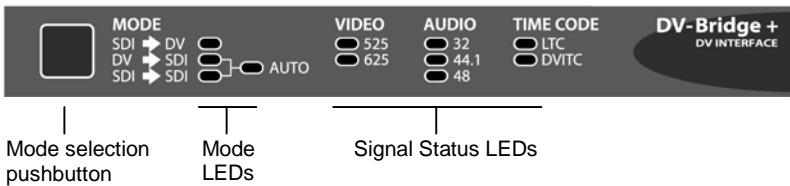

- To set the DV-Bridge+, simply push the button to select the desired mode; the mode toggles each time the button is pushed. Modes are:
- SDI→DV: encodes 4:2:2 video and AES audio to Digital Video. This mode will function even if there is no AES audio present.
 - DV→SDI: decodes Digital Video to 4:2:2 video and AES audio.
 - SDI→SDI: transfers between 4:2:2 video and AES audio source and destination.
 - Auto: This mode will detect if the source is DV or SDI and will either decode it or transfer it to an SDI destination equipment.

Note:

At any time, any encoding, decoding or transfer operation can be monitored using the analog video and audio outputs at the rear of the unit, allowing the use of an analog monitor. Alternatively, the analog output can be used to record from an SDI or DV source using a consumer VCR; simply select SDI→SDI to record from a SDI source and DV→SDI to record from a DV source (analog monitoring and recording are possible even if no SDI or DV destination equipment is connected to the unit).

The Mode LEDs are bicolor and indicate the status of the input signals, as follows:

GUIDE TO INSTALLATION AND OPERATION

- Green:** the mode is operating correctly;
- Red:** indicates an invalid or absent input signal. Check that the mode selected conforms to the equipment connected or verify that there is an input signal present and that cables are properly connected.
- Orange:** For DV→SDI mode only, indicates that a DV input is present but that its frame rate is far from the nominal frequency; the internal DV-Bridge+ VCXO is not able to lock correctly on this input. When this happens, pixellization effects can be expected on the SDI output as well as noise on the audio outputs cycling every few minutes.
(This occurs on PCs running Windows 2000 and Windows 98SE in NTSC; in effect, the PC outputs a NTSC DV signal with a frequency offset of -150 to -500 ppm, which is out of the VCXO capture range.)

The Signal Status LEDs indicate the video line format, audio sample rate and time code format.

3.2 DIP Switches on Bottom Panel

TIME CODE INSERTION LINE SELECTION

TC OSD ON



525	625	
OFF	OFF	0 0 0 0
13	14	0 0 0 1
14	19	0 0 1 0
15	8/10	0 0 1 1
16	9/11	0 1 0 0
17	10/12	0 1 0 1
18	11/13	0 1 1 0
10/12	12/14	0 1 1 1
11/13	13/15	1 0 0 0
12/14	14/16	1 0 0 1
13/15	15/17	1 0 1 0
14/16	16/18	1 0 1 1
15/17	17/19	1 1 0 0
16/18	18/20	1 1 0 1
17/19	19/21	1 1 1 0
18/20	20/22	1 1 1 1

The bottom panel has two sets of DIP switches, labelled to indicate their function as shown in figure 3.2. These switches are used to set up the DV-Bridge+ with respect to time code, default video standard, compression standard and control interface status, as described in the following sections.

The *TC OSD ON* switch lets you choose whether or not to display the time code at the 4:2:2 SDI output and at the monitoring output. Setting this switch to the "1" position enables the OSD; "0" disables it.



Figure 3.2 Underside of the DV-Bridge+

GUIDE TO INSTALLATION AND OPERATION

The *TIME CODE INSERTION LINE SELECTION* switches allow you to turn DVITC time code insertion on or off, and when on, to choose the lines where you want to insert the time code.

The *DEFAULT* switch lets you choose the default video standard (525 or 625 lines). The DV-Bridge+ supports both standards in the same session without setting any switches, but a lot of DV workstations are not able to do so. Those kinds of workstation set their software DV driver in one standard or the other only once at power-up by looking at which standard an attached DV device is working with. So in any case where you don't have an active video source (4:2:2) to set this standard, be careful to set this switch correctly before plugging the DV-Bridge+ into your DV workstation and before turning on the workstation.

The *COMPRESSION* switch lets you choose between DV25 or DVCPRO25 compression. This switch is only relevant if you are working in 625 lines because it is only in this case that these compressions are different. Most DV workstations work with DV25 compression. Keep in mind that this switch controls only the way that the DV-Bridge+ generates a DV stream on the iLink; it receives and correctly converts a DV stream into 4:2:2 without changing this switch.

The *TIMECODE* switches lets you choose the way that your time code sources are processed for a 4:2:2-to-DV transfer. The DV-Bridge+ supports LTC and DVITC time code. By setting the first dip switch in *AUTO*, the DV-Bridge+ automatically selects the right input. First, it looks for DVITC timecode in the 4:2:2 signal. If there are errors in this timecode, it changes to the LTC input. Finally, if there are also errors at this input or if no signal is present, the DV-Bridge+ itself generates the time codes in both standards. If you set the first dip switch to *MAN*, the second dip switch lets you manually select the appropriate time code source. In any case, both kinds of time code (LTC and DVITC) are generated whatever the conversion mode.

The *RS422* switch lets you choose the way that you will control the DV-Bridge+ and the video devices that are attached to it.

- If you set this switch to *CONTROLLING*, you are able to control the DV-Bridge+ and a 4:2:2 VTR via its serial port through the iLink as if it were a DV VTR. Table 3.1 shows the DV device commands that are supported under this option by the DV-Bridge+.

GUIDE TO INSTALLATION AND OPERATION

- If you set this switch to *TRIBUTARY*, you can control the DV-Bridge+ and a DV VTR by its iLink port through the RS-422 link as if it were a 4:2:2 VTR. Be careful to plug only one IEEE-1394 device into the DV-Bridge+ in this mode. This device should be a DV VTR if you want to be able to control it. Table 3.2 shows the Sony protocol commands that are supported under this option by the DV-Bridge+.

3.3 Device Control

The DV-Bridge+ now supports most AV/C commands on the iLink. When using this protocol to communicate with the DV-Bridge+, you should consider it as a VTR and use the appropriate AV/C commands for this type of AV device. The following AV/C commands can be associated with these modes.

Table 3.1 DV Device Control (IEEE-1394 AV/C VTR Commands) in controlling mode

Supported DV Device Commands (IEEE-1394 VTR AV/C Commands)	Mode
(syntax: NAME (opcode,first operand))	
ABSOLUTE TRACK NUMBER (52h,71h)	
CONNECT AV (20h,XXh)	
INPUT PLUG SIGNAL FORMAT (19h,XXh)	
INPUT SIGNAL MODE (79h,FFh)	
MEDIUM INFO (DAh,7Fh)	
OUTPUT PLUG SIGNAL FORMAT (18h,XXh)	
OUTPUT SIGNAL MODE (78h,FFh)	
PLAY FASTEST FORWARD (C3h,3Fh)	
PLAY FASTEST REVERSE (C3h,4Fh)	
PLAY FORWARD (C3h,75h)	SDI to DV
PLAY FORWARD PAUSE (C3h,7Dh)	SDI to DV
RECORD (C2h,75h)	DV to SDI
RECORD PAUSE (C2h,7Dh)	DV to SDI
PLAY NEXT FRAME (C3h,30h)	
PLAY PREVIOUS FRAME (C3h,40h)	
WIND FAST FORWARD (C4h,75h)	
WIND REWIND (C4h,65h)	
WIND STOP (C4h,60h)	SDI to SDI
RECORDING SPEED (DBh,7Fh)	
SUBUNIT INFO (31h,XXh)	
TIME CODE (51h,71h)	
UNIT INFO (30h,FFh)	

GUIDE TO INSTALLATION AND OPERATION

Table 3.2 Sony Protocol Commands supported

Supported Sony Protocol Commands <i>(as defined for BVW-75 VTR)</i>	Mode
(syntax: <i>NAME</i> (first opcode, second opcode, ...))	
<i>FAST FORWARD</i> (20h,10h)	
<i>JOG FORWARD</i> (2Xh,11h) *	
<i>JOG REVERSE</i> (2Xh,21h) *	
<i>PLAY</i> (20h,01h)	DV to SDI
<i>REC</i> (20h,02h)	SDI to DV
<i>REWIND</i> (20h,20h)	
<i>SHUTTLE FORWARD</i> (2Xh,13h) *	
<i>SHUTTLE REVERSE</i> (2Xh,23h) *	
<i>STATUS SENSE</i> (61h,20h)	
<i>STOP</i> (20h,00h)	SDI to SDI
<i>TIMECODE GEN DATA SENSE</i> (61h,0Ah)	
<i>VAR FORWARD</i> (2Xh,12h) *	
<i>VAR REVERSE</i> (2Xh,22h) *	

* These commands can have a different effect on the DV-Bridge+ than on a real 4:2:2 VTR

4 Troubleshooting

1- When using some camcorder models as a DV source, the DV signal may be lost if you try to unplug the iLink cable from the DV-Bridge+ during the transmission. To recover from this situation, turn the camcorder off and then on again.

2- Macintosh users will have some problems if they try to toggle the video format (525 to 625 or 625 to 525) in the same session; they will not be able to process the video sequences correctly in the new format. The DV-Bridge+ must be powered on in the right video format (even if no input signal is connected to the unit) before attempting to start the computer and launch the editing software. Additionally, when no input signal is connected, the DV-Bridge+'s default line format will still be detected by the computer, causing the same problem if it is not the format that the editing software will use. Set the required default line format by using the *DEFAULT* switch on the underside of the DV-Bridge+.

This issue is well known and documented on the Apple web site for any kind of DV source.

5 Specifications

DV INPUT/OUTPUT

Signal(2): DV on IEEE-1394/i.LINK/Firewire
Connectors: 4 pin and 6-pin IEEE-1394 sockets

INPUT

Video input

Video signal: 4:2:2 SMPTE 259M-C (270 Mbps)
Cable length: 250m (850') (Belden 8281)
Return loss: >15 dB up to 270 MHz

Audio input

Audio signal: AES-3id-1995 (SMPTE 276M)
Level: 1.0 Vp-p
Impedance: 75 Ω unbalanced
Sampling rate: 32, 44.1, 48 kHz

DIGITAL OUTPUT

Video output

Video signal: 4:2:2 SMPTE 259M-C (270 Mbps)
Return loss: >15 dB up to 270 MHz

Audio output

Audio signal: AES-3id-1995 (SMPTE 276M)
Level: 1.0 Vp-p
Impedance: 75 Ω unbalanced
Sampling rate: 32, 44.1, 48 kHz
Jitter: < 0.3 UI

ANALOG OUTPUT

Video output

Video signal: NTSC (525/60) SMPTE 170M
PAL (625/50) ITU-R BT.470-6.
Return loss: >20 dB up to 5 MHz
Video signal: S-Video (Y-C)
Return loss: >20 dB up to 5 MHz
Connector: 4 pin mini-DIN

Audio output

Audio signal: Stereo unbalanced line out
Level: 3.5 Vp-p

GUIDE TO INSTALLATION AND OPERATION

PROCESSING PERFORMANCE

Compression:	DV format at 25 Mbps per DV Blue Book and DVCPRO DV 4:1:1 in NTSC, 4:2:0 in PAL, DVCPRO 4:1:1 in PAL
Delay:	DV→SDI mode: 1.5 frames (TBC) SDI→DV mode: 1.5 frames (TBC) SDI SDI mode: 2 μ s (TBC)

ANALOG OUTPUT QUANTIZATION

Video:	8 bits
Audio:	16 bits
Physical size:	190 mm X 115 mm X 40 mm (7.5" X 4" X 1.6")

ELECTRICAL

Power input range:	100-240 V / 50-60 Hz
Power:	13 W