

# RCP-BR Panel

## Guide to Installation and Operation

M885-9900-104

November 2011



Miranda Technologies Inc.  
3499 Douglas-B.-Floreani  
St-Laurent, Québec, Canada H4S 1Y6  
Tel. 514-333-1772  
Fax. 514-333-9828  
[www.miranda.com](http://www.miranda.com)

© 2011 Miranda Technologies Inc.

Copyright © 2011 Miranda Technologies Ltd. All rights are reserved and, under the copyright laws, this manual may not be reproduced in any form, in whole or in part, without the prior written consent of Miranda Technologies Ltd.

Windows®95, Windows®98, Windows®2000, Windows®NT and Windows®XP are registered products of Microsoft Inc.

## Compliance Information

### Electromagnetic Compatibility



This equipment has been tested for verification of compliance with FCC Part 15, Subpart B requirements for Class A digital devices.

---

*NOTE: This equipment has been tested and found to comply with the limits for a Class A digital device, pursuant to part 15 of the FCC Rules. These limits are designed to provide reasonable protection against harmful interference when the equipment is operated in a commercial environment. This equipment generates, uses, and can radiate radio frequency energy and, if not installed and used in accordance with the instruction manual, may cause harmful interference to radio communications. Operation of this equipment in a residential area is likely to cause harmful interference in which case the user will be required to correct the interference at his own expense.*

---



**This equipment has been tested and found to comply with the requirements of the EMC directive 2004/108/CE:**

- EN 55022 Radiated emissions Class A
- EN 55022 Conducted emissions Class A
- EN 61000-3-2 Harmonic current injection
- EN 61000-3-3 Voltage changes, voltage fluctuations and flicker
- EN 61000-4-2 Electrostatic discharge immunity
- EN 61000-4-4 EFT/Burst immunity
- EN 61000-4-5 Surge immunity
- EN 61000-4-6 Conducted immunity
- EN 61000-4-11 Voltage dips, short interruptions and voltage variations immunity

## How to contact us:

For technical assistance, please contact the Miranda technical support centre nearest you.

### **Americas**

*Telephone:*

+1-800-224-7882

*e-mail:*

techsupp@miranda.com

### **Asia**

*Telephone:*

+852-2539-6987

*e-mail:*

asiatech@miranda.com

### **Europe, Middle East, Africa, UK**

*Telephone:*

+44 (0) 118 952 3400

*e-mail:*

eurotech@miranda.com

### **China**

*Telephone:*

+86-10-5873-1814

*e-mail:*

asiatech@miranda.com

### **France (only)**

*Telephone:*

+33 (0) 1 55 86 87 88

*e-mail:*

eurotech@miranda.com

Visit our web site at [www.miranda.com](http://www.miranda.com)

## Table of contents

<b>1</b>	<b>RCP-BR Panel .....</b>	<b>1</b>
1.1	Introduction .....	1
1.2	Features .....	1
<b>2</b>	<b>Setting up of the RCP-BR panel.....</b>	<b>2</b>
2.1	Connecting up the panel .....	2
2.2	Network configuration.....	3
2.3	Station configuration.....	5
2.3.1	Setting up the station configuration .....	7
<b>3</b>	<b>Using the RCP-BR panel.....</b>	<b>15</b>
3.1	Turning on the unit .....	15
3.2	Turning off the unit (Shutting down) .....	15
3.2.1	Shutting down from the System Panel screen .....	16
3.2.2	Shutting down from small Control Window Dialog .....	17
3.3	Starting up an already shut-down RCP-BR unit.....	17
3.4	Panel basics .....	18
3.4.1	Panel Lock button.....	19
3.4.2	Channel Select .....	19
3.4.3	DSK Off .....	19
3.4.4	Take.....	19
3.5	Selecting a channel .....	20
3.5.1	Channel ganging .....	20
3.5.2	User channels .....	22
3.6	The Main panel.....	24
3.6.1	Cutting a keyer up or down .....	26
3.6.2	Setting fade rates .....	27
3.6.3	Cutting a voice-over up or down.....	28
3.6.4	Macros.....	29
3.6.5	Fade to black / silence.....	30
3.6.6	Arming multiple events on a Take .....	30
3.7	Loading media into a keyer .....	31

3.7.1	Filter .....	34
3.8	Modifying media in a keyer .....	36
3.8.1	Adjusting media position .....	36
3.8.2	Adjusting the media cropping .....	37
3.8.3	Adjusting the media clip, gain and transparency .....	38
3.8	Audio .....	39
3.9	Voice-overs .....	41
3.9.1	Easyplay media browsing .....	42
3.10	The System panel .....	44
3.11	Alarms .....	46
<b>4</b>	<b>The web interface .....</b>	<b>47</b>
4.1	Maintenance .....	49
4.1.1	Update .....	50
4.1.2	Update history .....	51
4.1.3	Licenses .....	52
4.1.4	Install panels .....	53
4.1.5	System restart .....	54
4.1.6	System shutdown .....	55
4.2	Diagnostics .....	56
4.2.1	Retrieve log files .....	57
4.2.2	Watch log .....	59
4.2.3	Running processes .....	60
4.3	Setup .....	61
4.3.1	Network setup .....	62
4.3.2	Set hostname .....	63
4.3.3	Time setup .....	64
4.3.4	Mouse setup .....	65
4.3.5	Serial number .....	66
4.3.6	Station .....	66
<b>5</b>	<b>Installation .....</b>	<b>67</b>
5.1	Mounting .....	67
5.1.1	Mounting with ears .....	67

5.1.2	Mounting with 30 degree brackets .....	69
5.1.3	With 60 degree Desk-Mounting kit, RCP-BR-DM-KIT.	70
5.1.4	With Rack-Mounting kit, RCP-BR-RM-KIT .....	71
5.2	Ventilation .....	72
5.3	Power requirements .....	72
5.4	RCP-BR rear connections .....	73
5.4.1	Summary .....	73
5.4.2	DC power connector pinout (8 pin DIN, female) .....	74
5.4.3	GPIO pinout (15-way D-type) .....	75
5.5	Mechanical .....	76
5.6	Environment .....	76
5.6.1	Operating .....	76
5.6.2	Storage .....	76
5.7	Other .....	77
5.7.1	RTC battery .....	77
5.7.2	Compact Flash .....	77





# 1 RCP-BR Panel

## 1.1 Introduction

The highly graphical, touch screen Branding Panel provides highly informative and easy control of Miranda's channel branding processors, including the Intuition-XG, the Imagestore 750, and the Densite LGK-3901 / DSK-3901 and Imagestore-Modular products.

## 1.2 Features

### FLEXIBLE AND USER-FRIENDLY CONTROL PANEL

- Rich graphical interface
- Customizable layouts via standalone software running on a PC
- Combination of touch screen and button control
- Intuitive operation
- Full tallies from devices under control

### COMPLETE CONTROL FOR BRANDING APPLICATIONS

- Full keyer and voice-over control
- Media browsing with graphical thumbnails
- Quick adjustment of parameters via rotaries
- Custom branding macro recall
- Easy configuration of keyers and voice-overs

### OPTIMIZED FOR MULTI-CHANNEL ENVIRONMENTS

- Channel ganging capable (simultaneous multi-channel control)
- Easy to use channel selector

### ELEGANT DESIGN AND SIMPLE CONNECTIVITY

- 1/2 rack / 3RU form factor
- Desk or turret mount
- Connects to branding devices via Ethernet (Oxtel protocol)
- Two USB ports for software upgrades or mouse/keyboard

## 2 Setting up of the RCP-BR panel

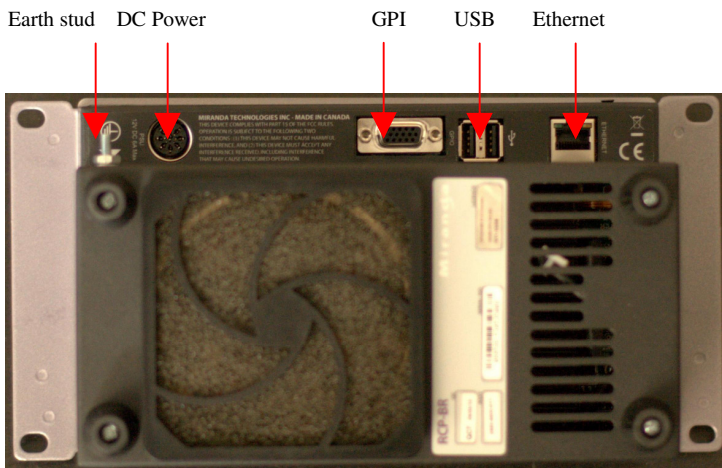
Before using the RCP-BR panel to control a system, two things will need to be setup, these are:

1. The networking configuration.
2. The station configuration which defines which devices the panel will control and the configuration of these devices into channels.

These will be explained in this section.

### 2.1 Connecting up the panel

Please refer to Figure 2-1 for a picture of the rear of the RCP-BR panel. For normal usage an Ethernet cable must be inserted with a connection to the network that the devices to be controlled are on. In addition there is an earth stud for earthing the unit.



*Figure 2-1* Main rear connections for the RCP-BR panel

To power up the unit connect the remote power adapter to the power socket on the RCP-BR panel before the power adapter is connected to the mains supply.

## 2.2 Network configuration

The RCP-BR panel comes pre-configured to use DHCP to automatically configure its networking. If a different network configuration is required for the unit then the panel's Control Window provides the facilities for changing the settings. Once the unit has started up and the Channel Selector dialogue is displayed, the *System* menu can be accessed. This is shown in Figure 2-2 and from here the *Switch to control window* option can be selected.



*Figure 2-2* The *System* panel

This will display the dialogue as shown in **Error! Reference source not found.** On the touchscreen press the *Network* button.



**Figure 2-3** Control window dialogue

This will display the network settings as shown in Figure 2-4.



**Figure 2-4** Network settings

You can now use the touchscreen to switch between DHCP and Static options. If a static IP option is selected, then the touchscreen must also be used to define the required IP address, the subnet mask and the default gateway. Once the required settings are entered, select the *Apply* button to use the new settings.

## 2.3 Station configuration

Before starting to use the RCP-BR panel the station configuration for the unit must be setup. The station configuration defines the devices which the panel should control. These devices could be any of the following:

- Imagestore 300
- Imagestore HD
- Imagestore 750
- LGK-3901
- DSK-3901
- Imagestore-Modular (aka ISM-3901)
- Imagestore-Modular + Branding Animation Playout Package
- HMP-1801
- Intuition+
- Intuition XG

These devices then need to be assigned channels. A channel can consist of one of the following combinations:

1. One ImageStore, LGK-3901 or DSK-3901
2. One Intuition, Intuition+, Intuition XG or HMP-1801
3. One ImageStore, LGK-3901 or DSK-3901 with one Intuition, Intuition+, Intuition XG or HMP-1801

For information on other Miranda devices not in this list please contact Miranda.

Please note that increasing the number of channels and devices can slow down RCP-BR operation. The number of devices is limited to 30 and Miranda recommends a maximum of 20 channels. Please contact [support@miranda.com](mailto:support@miranda.com) if you need to create more devices.

To ensure correct operation of the RCP-BR (software version 4.7), appropriate software versions need to be installed on all controlled devices. The minimum recommended versions are:

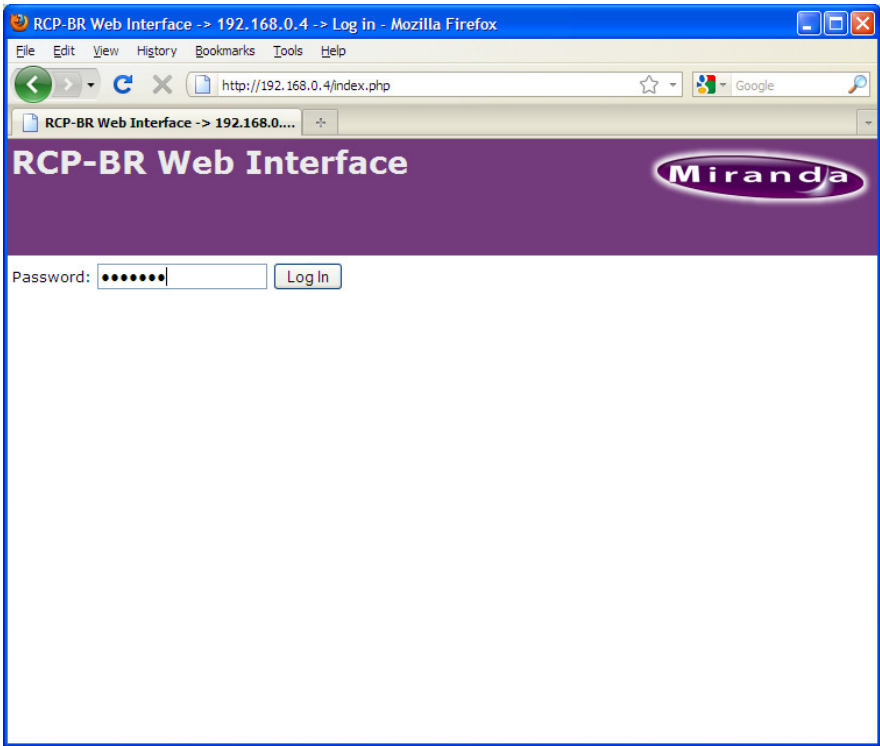
Imagestore 300, Imagestore HD, Intuition, Intuition+	1.13.8.1
Imagestore 750	3.1.2 <sup>1</sup>
LGK-3901, DSK-3901	3.1.2 <sup>1</sup>
Intuition-XG	4.5
Imagestore-Modular	3.1.2 <sup>1</sup>
HMP-1801	5.1.0

---

<sup>1</sup> For full support of Easyplay media browsing for voice-overs on Imagestore 750 and LGK-3901, software version 3.1.3 is required. Please contact Miranda support for further details.

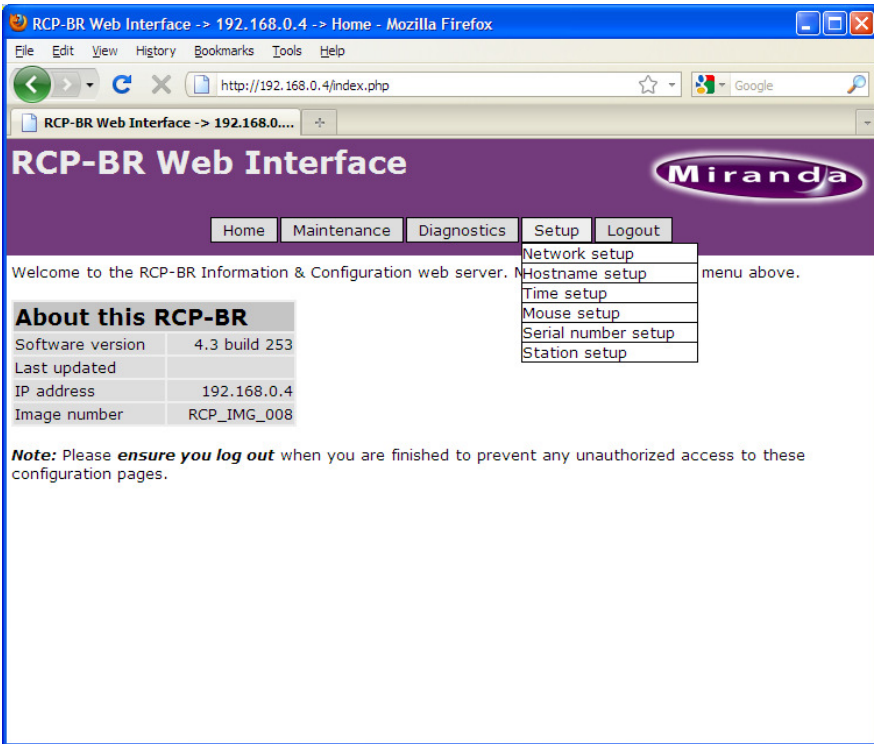
### 2.3.1 Setting up the station configuration

The station configuration is set up from the RCP-BR's web interface. Open your preferred web browser and type in the IP address or the hostname of the RCP-BR into the location bar. This will display the login page for the RCP-BR panel as shown in Figure 2-5.



*Figure 2-5* Web interface log-in page

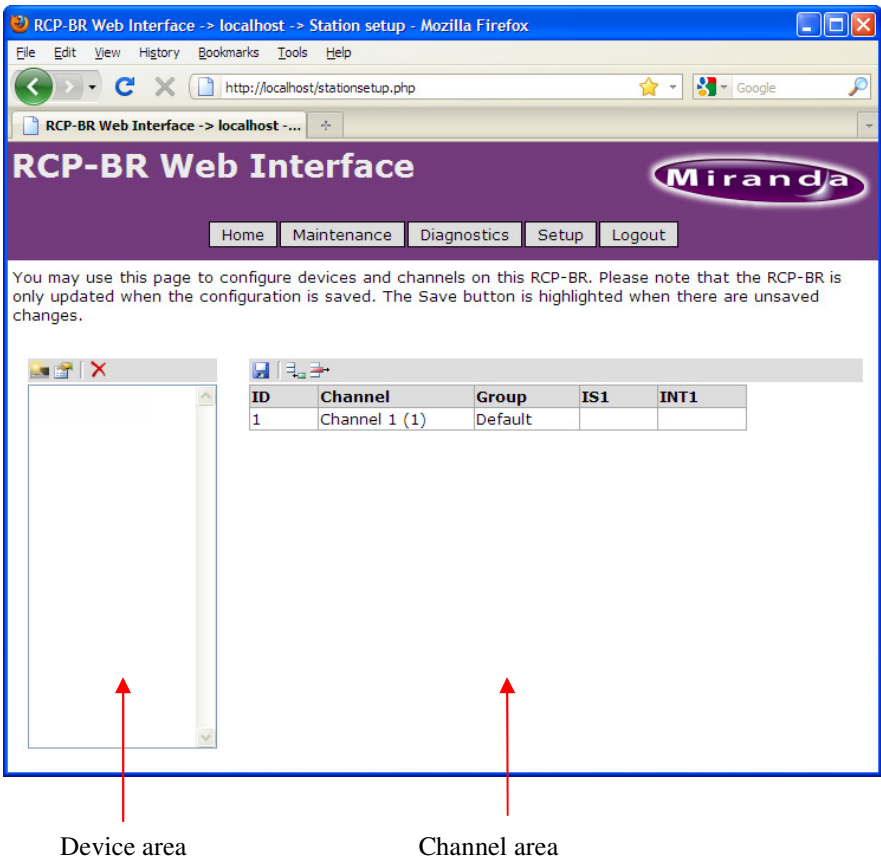
To login, type in the password 'miranda'. This will open the home page as shown in Figure 2-6.



**Figure 2-6** Web interface home page

Selecting the “Station setup” option from the Setup menu will display the page shown in Figure 2-7.



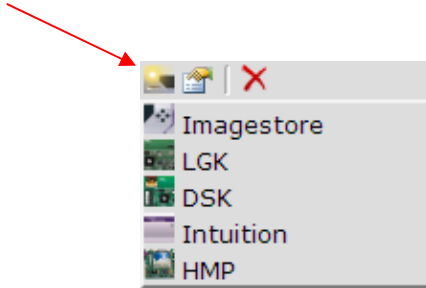


*Figure 2-7* Station setup page

The first operation to carry out is the definition of the devices that will be controlled by the RCP-BR panel. These devices are added in the device area which is on the left of the page.

To add a device, select the ‘New device’ icon on the toolbar at the top of the device area as shown in Figure 2-8. This will drop down a list of the devices supported by the panel.

**New device icon**



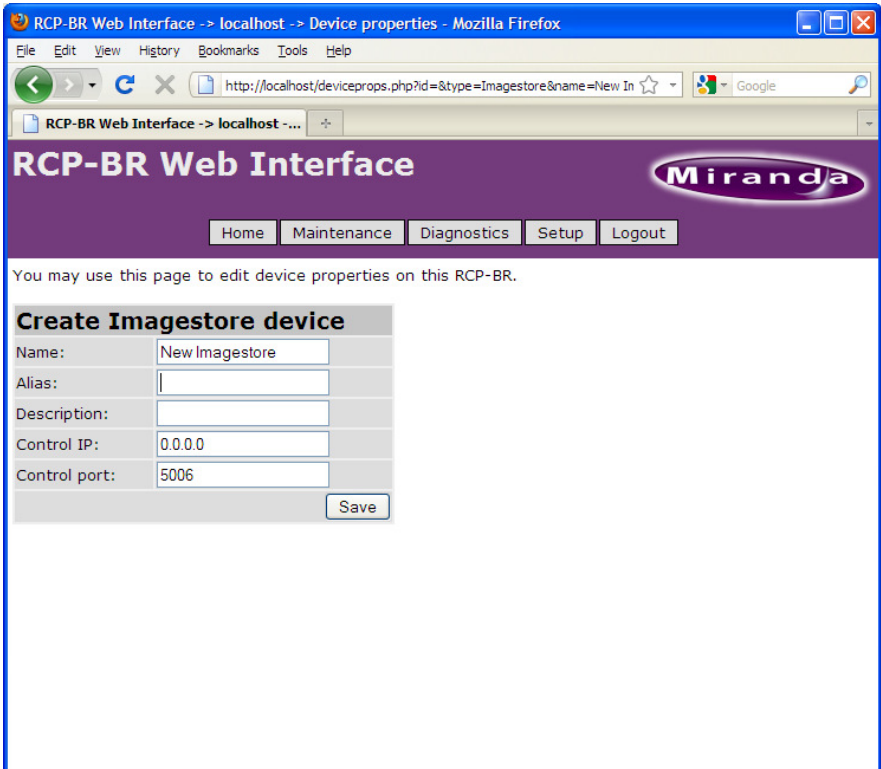
**Figure 2-8** Device toolbar

Having selected the appropriate device from this list, the setup page for the device will be shown. See Figure 2-9.

The device toolbar also contains buttons to edit the properties of existing devices and to delete devices.

**Note:** When configuring an RCP-BR to control “Intuition-XG” units, please select the device type of “Intuition”.

On this page the device name and other properties can be defined. Having made the changes to define the device select the ‘Save’ option. This will close the page and return to the main station setup page. You will now see the new device appear in the device area of the page.



The screenshot shows a web browser window titled "RCP-BR Web Interface -> localhost -> Device properties - Mozilla Firefox". The address bar shows the URL "http://localhost/deviceprops.php?id=&type=Imagestore&name=New In". The page header includes the "RCP-BR Web Interface" logo and the "Miranda" logo. Below the header are navigation buttons for "Home", "Maintenance", "Diagnostics", "Setup", and "Logout". The main content area contains the text "You may use this page to edit device properties on this RCP-BR." and a form titled "Create Imagestore device". The form has the following fields:

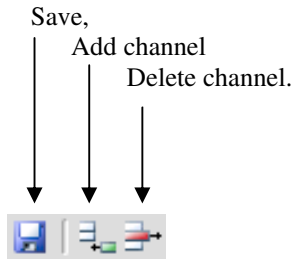
Name:	<input type="text" value="New Imagestore"/>
Alias:	<input type="text"/>
Description:	<input type="text"/>
Control IP:	<input type="text" value="0.0.0.0"/>
Control port:	<input type="text" value="5006"/>

At the bottom right of the form is a "Save" button.

*Figure 2-9* Configuration for a new device

Having defined all the devices that are to be controlled by the RCP-BR panel it is then necessary to setup the channels. Devices can then be assigned to appropriate channels.

Firstly a new channel should be created by clicking on the ‘Add channel’ option in the channel toolbar as shown in Figure 2-10. The options on the toolbar are Save, Add channel and Delete channel.



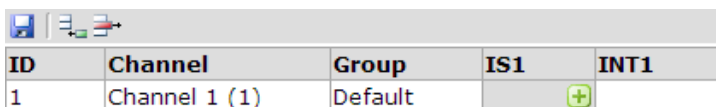
**Figure 2-10** Channel toolbar

Note: The RCP-BR panel is only updated when the Save option is selected from the channel toolbar. This option is highlighted when the page contains unsaved changes to the configuration.

By default, a new channel is created with one “Imagestore” column and one “Intuition” column (columns IS1 and INT1 respectively). Devices from the device area of the page can then be assigned to the new channel:

- Select the device from the list
- Click on a blank cell in the IS1 or the INT1 column as appropriate.
- You should see a plus button ( + ) appear as shown in Figure 2-11.
- Click on the button to assign the device to the channel.

Note : Imagestore, DSK and LGK devices can only be assigned to the IS1 column. Intuition and HMP devices can only be assigned to the INT1 column.



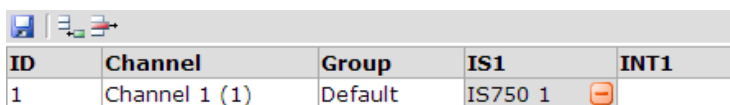
ID	Channel	Group	IS1	INT1
1	Channel 1 (1)	Default	+	

**Figure 2-11** Assigning a device to a channel

A channel may consist of just a single Intuition or Intuition-XG. These devices are placed in the INT1 column, with no device in the IS1 column.

For a channel comprising an Imagestore-Modular with BAPP, add an LGK device into the IS1 column and an HMP device into INT1 column.

A device can only be assigned to one channel, so if it is required by another channel then it must first be removed from the channel using it. To remove an assigned device from a channel, click on the cell that contains the device and a minus sign button ( - ) will appear as shown in Figure 2-12. Click on the minus sign to remove the device assignment.

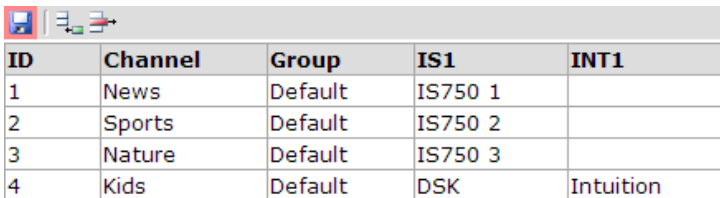


ID	Channel	Group	IS1	INT1
1	Channel 1 (1)	Default	IS750 1	-

**Figure 2-12** Removing a device assignment


A typical configuration is shown in Figure 2-13.

Under the 'Group' column you can optionally define a group for a channel. If all channels are left as Default then they will all be shown in one view on the channel selector. This works well if there are only a few channels, but if you want to show the channels in groups then entering a Group name will separate the channels in the channel selector into their appropriate groups. An example of groups is to create three groups - News, Sport & Default.



ID	Channel	Group	IS1	INT1
1	News	Default	IS750 1	
2	Sports	Default	IS750 2	
3	Nature	Default	IS750 3	
4	Kids	Default	DSK	Intuition

**Figure 2-13** Typical setup of station configuration

 Having completed the setup of the station configuration, select the Save option in the channel toolbar. This will save the station configuration to the RCP-BR panel.

The RCP-BR panel should now be ready for use.

## 3 Using the RCP-BR panel

### 3.1 Turning on the unit

The RCP-BR unit is DC-powered and a DC power supply unit is supplied with the RCP-BR that runs off of an AC mains supply.

To turn on the unit:

1. Ensure that the AC mains supply to the RCP-BR is off or not connected for at least 10 seconds.
2. Then insert the DC power supply connector into the unit
3. Then apply AC mains to the power supply unit.

The LCD on the RCP-BR panel should initially be off; the LEDs on the bar at the bottom of the unit should gradually change colour from left-to-right to indicate the progress of the unit's initialisation. Shortly after the progress bar has reached the right hand side, the LCD display will turn on showing the channel selector view.

**Do not remove power while unit is booting.**

### 3.2 Turning off the unit (Shutting down)

The RCP-BR must be shutdown.

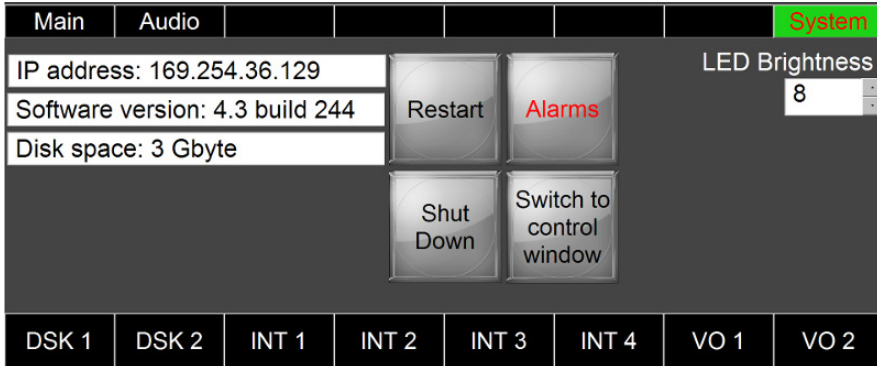
The RCP-BR must not be directly turned off.

**Do not remove power while the unit is shutting down.**

The RCP-BR unit is normally shutdown via the System Panel screen. In some cases, the user may wish to shut down from the small Control Window Dialog. The procedure for both is described below:-

### 3.2.1 Shutting down from the System Panel screen

It is essential that the unit is turned off correctly. To shut down the unit go into the System panel by selecting the System button on the top bar. This will open the System panel as shown in figure 3-1.



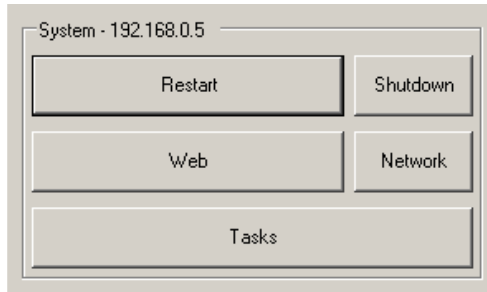
**Figure 3-1** System panel

On the touchscreen press the 'Shut Down' button and the panel will change to display two new buttons – 'Confirm Shut Down' and 'Cancel'. To continue shutting down the unit press the confirm option. The panels will all close down and soon after the LCD will turn off, and the bottom bar will show a progress bar of the LEDs going out. The unit must not be turned off until all the LEDs have gone out. To power down the unit the mains supply to the RCP-BR panel power connector must be removed. Do not pull the power connector out of the back of the unit until the shut down process has completed and the mains has been removed from the power connector.



### 3.2.2 Shutting down from small Control Window Dialog

It is essential that the unit is turned off correctly. To shut down the unit from the Control Window dialog (shown in figure 3-2) press the “Shutdown” touchscreen button.



**Figure 3-2** System Dialog

### 3.3 Starting up an already shut-down RCP-BR unit

A RCP-BR that has been shut down, will require the power to be temporarily removed and re-applied by disconnecting the AC mains from the RCP-BR’s power supply unit for 10 seconds and re-applying.

### 3.4 Panel basics

The RCP-BR panel provides three input mechanisms for controlling the selected devices. These are:

1. Physical buttons. These are arranged in three rows with some dedicated buttons and the remainder which change their functionality during operation.
2. Rotaries. These are used for setting adjustable values and scrolling the media browsers. If the rotary is pressed down and rotated the value being adjusted will change more quickly.
3. Touchscreen. This allows the operator to control some functions within the panels.

Figure 3-3 shows a panel with key buttons labelled.

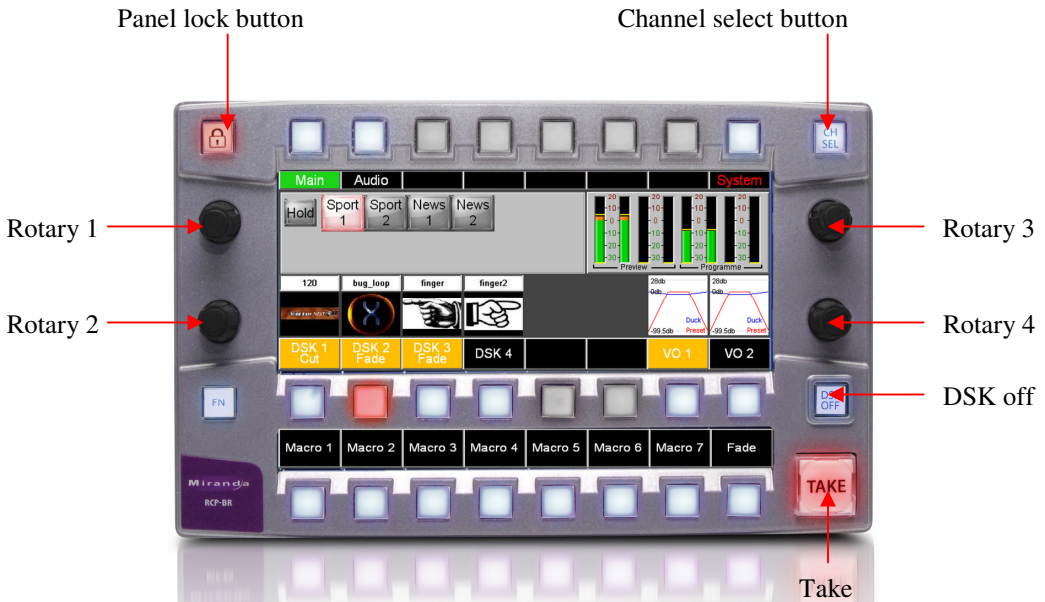


Figure 3-3 RCP-BR panel with fixed buttons and rotaries labelled

### **3.4.1 Panel Lock button**

When the Panel Lock button is pressed, the button will light up red and in this mode all the buttons on the panel and the touchscreen are disabled until this mode is deselected.

### **3.4.2 Channel Select**

When the RCP-BR panel starts up or when the channel select button is pressed the channel selection panel is displayed. This panel allows the operator to select a channel or to gang channels together. This functionality is discussed in detail in section 3.4.

### **3.4.3 DSK Off**

If a channel is selected then pressing this button will cut all Imagestore and Intuition keyers down immediately. This will bypass any arm and take setup.

### **3.4.4 Take**

If a channel is selected and a DSK, VO or macro are armed, this button will flash to indicate that a function is armed. In this situation pressing the Take button will action all armed events.

### 3.5 Selecting a channel

On start-up or when the CH SEL button is pressed the channel select panel will be displayed. An example of the panel is shown in figure 3-4.



*Figure 3-4* Channel selection panel

The buttons showing Default, Sports and News are groups of channels. This is set up in the station configuration where channels can be optionally assigned groups. Selecting the appropriate group button will show only those channels assigned to the group.



This warning icon which is shown for some channels indicates that there is a connection error to one of the devices on the channel. As soon as this connection error is resolved this icon will be automatically removed. A connection error will be caused by such issues as loss of network communications to the device, the unit being turned off or restarting.

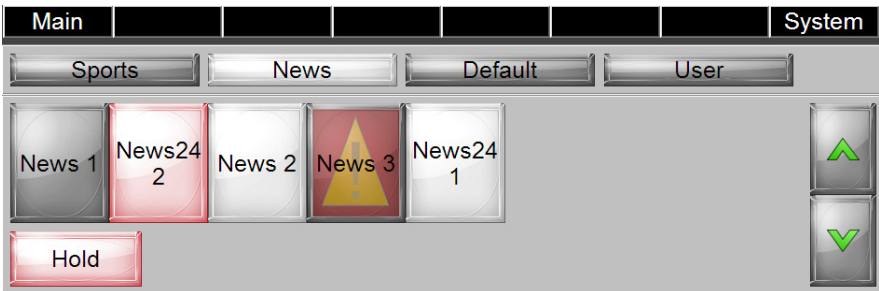
If there are more than 8 channels in a group the channels can be scrolled up or down using the scroll up/down buttons at the right hand edge of the panel.

#### 3.5.1 Channel ganging

It is possible to gang two or more channels together. Whenever channels are ganged any operations carried out on the panel will be sent to all ganged channels. In this way it is possible to carry out simultaneous actions such as keyer control

on multiple channels simultaneously. To gang channels press the 'Hold' button so that it lights up red. Once this button is selected pressing any subsequent channel buttons will light these up in addition to those already lit. The first channel selected is known as the master channel and is lit up red. The importance of the master channel is that the RCP-BR panel only displays the status of this channel. Indication such as which media is loaded into a channel or which keyers are cut up is based on tallies coming back from this device. The channels lit up white are known as 'slave' channels so any action carried out on the RCP-BR panel will be carried out on these channels but the status of these channels will not be reflected on the RCP-BR panel.

If you press a slave channel button again the channel will be deselected from the ganged channels and the button illumination will go out. If the master channel is pressed then the master channel will be dropped from the ganged group and one of the slave channels will become the master channel.

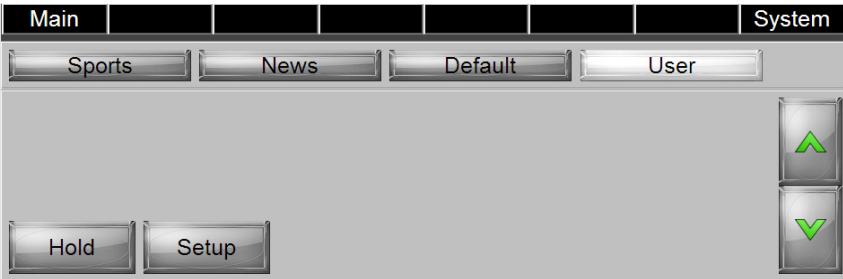


**Figure 3-5** Channel selector in ganging mode.

To come out of ganging mode press the hold button again so that the illumination of the button goes out. If channels are already ganged then this will not disable the ganging but as soon as a new channel is selected, control of all the ganged channels will be dropped and the newly selected channel will be the only channel in action.

### 3.5.2 User channels

It is possible for the user to select a subset of ‘user’ channels in the channel selector which are to be controlled by the operator. To do this press the user button as shown in figure 3-6.



**Figure 3-6** User channel selection

When the ‘User’ button is pressed the user selected channels will be displayed in the panel. To add new channels to the user list select the ‘Setup’ button. This will display all the channels from all the groups as shown in figure 3-7.



**Figure 3-7** Setup of the user channels

In user channel setup one or many channels can be selected. These channel buttons will be lit white. It is important to note that this mode has no connection to channel ganging. The indication of channels in white just indicates that these channels are being added to the user channel list. When the required channels

have been selected the OK button is pressed and the user channel selection panel will be shown with these new channels.

### 3.6 The Main panel

To get to the Main panel press on the ‘Main’ button which is always the first button on the top row of buttons above the LCD.



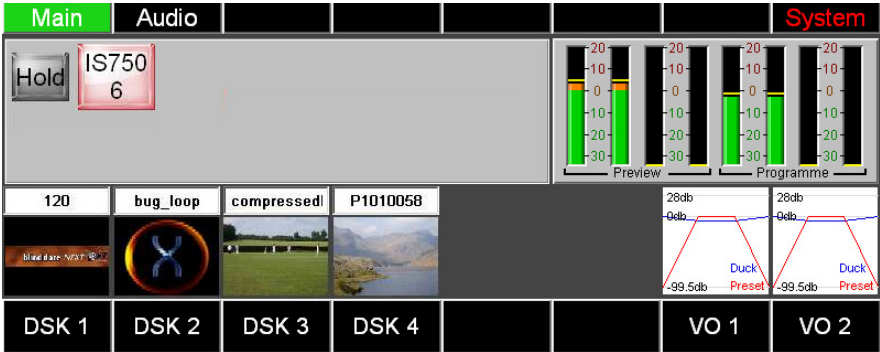
Figure 3-8 RCP-BR panel showing the Main panel

The main panel gives an overview of the status of the devices being controlled. It contains thumbnails showing the media and name of the graphic loaded into each keyer. It shows the setup of the two voice-overs and a monitor of the audio output if an Imagestore is attached to the channel.

In addition to the overview of the channel status there is another channel selector on this panel. This channel selector shows all the channels assigned to the ‘user’ channel and will also show any channels which have been selected during the operation of the RCP-BR panel which are not in the ‘user’ selected channels.



There is also a Hold button to enable channel ganging to be carried out without having to revert to the channel selector panel again.



**Figure 3-9** Main panel

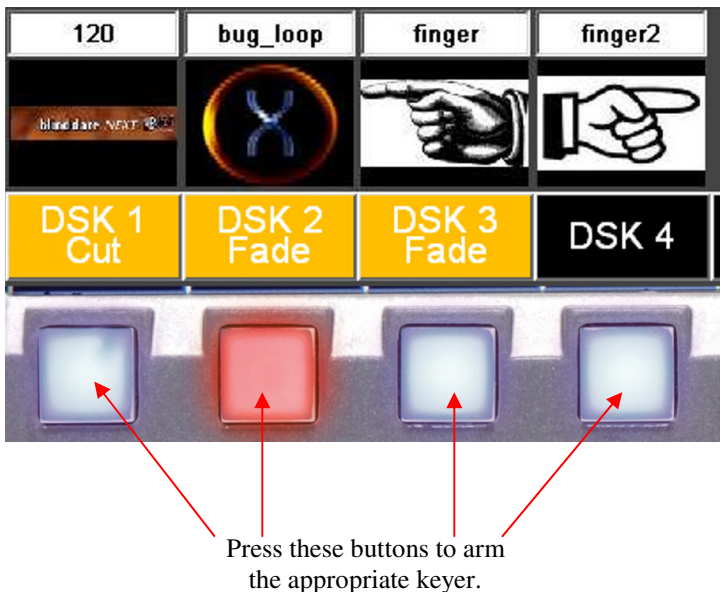
The assignment of keyers shown in this panel will change depending on the configuration of the panel. The first six positions will always be assigned to keyers and the second two positions will be assigned to voice-overs. If an Imagestore, DSK-3901 or LGK-3901 is assigned to a channel this will always take up the first keyers depending on the number of keyers in the device. If an Intuition is assigned to a channel and if there is no Imagestore, LGK-3901 or DSK-3901 the Intuition will take up all six keyer positions. Otherwise the Intuition will take the remaining keyer positions after the Imagestore keyers.

Similarly the VO information will only be shown if an Imagestore is assigned to a channel.

If you press the touchscreen in an area with the DSK label or on the image thumbnail this will move to the media selector panel for the keyer. If the touchscreen area with the VO label is pressed the VO setup panel will be displayed. Pressing on the audio meters will display the Audio Setup panel.

### 3.6.1 Cutting a keyer up or down

The RCP-BR panel utilises an arm and take mechanism for cutting keyers up or down. This means that multiple events can be triggered simultaneously. To arm a keyer press the keyer button on the middle button bar. The current arm state for the keyer is indicated in the LCD region directly above the keyer button. See figure 3-10.



**Figure 3-10** Keyer buttons with arm state indication

If the area on the LCD is lit as amber this indicates that the keyer is armed to either cut or fade up or down. Pressing the keyer button will follow the sequence:

1. Arm cut up/down
2. Arm fade up/down
3. Disarm keyer

The current state of the keyer is indicated by the button. If the button is lit red then the keyer is currently cut up.

Once the keyer is armed, to carry out the armed action, press the ‘Take’ button which will be flashing red to indicate that an item is armed.

### 3.6.2 Setting fade rates

The fade rate for the DSK transition can be set in fields from 0-100. To set the rate it is necessary to switch to the DSK Setup panel. To get to the DSK Setup panel the DSK Media panel should be selected first. To open this panel press on the DSK label above the DSK. Once in the DSK Media panel, the Setup panel can be selected by pressing the Setup button in the top row. This will open the panel shown in figure 3-11.

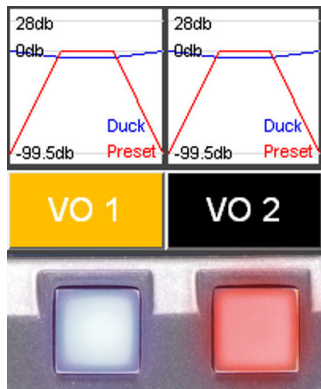


*Figure 3-11* DSK Setup panel

To adjust the DSK fade rate adjust the top right hand rotary, turning clockwise increases the delay and anti-clockwise decreases the delay.

### 3.6.3 Cutting a voice-over up or down

The RCP-BR panel utilises an arm and take mechanism for cutting up or down voice-overs. To arm a voice-over press one of the VO buttons on the middle button bar. The current arm state for the keyer is indicated in the LCD region directly above the voice-over button, see figure 3-12.



**Figure 3-12** Voice-over buttons and arm indicator

When the voice-over is armed the LCD indicator area above the button is lit amber, when the indicator is black this indicates that the voiceover is not armed. When the button is lit red this indicates that the voice-over is cut up and when the button is off this indicates that the voice-over is cut down. Having armed a voice-over to cut up or down this will be carried out when the Take button is pressed.

### 3.6.4 Macros

The RCP-BR panel utilises an arm and take mechanism for initiating the action of a macro. To arm a macro press one of the macro buttons on the bottom button bar. The current arm state for the macro is indicated in the LCD region directly above the macro button, see figure 3-13.

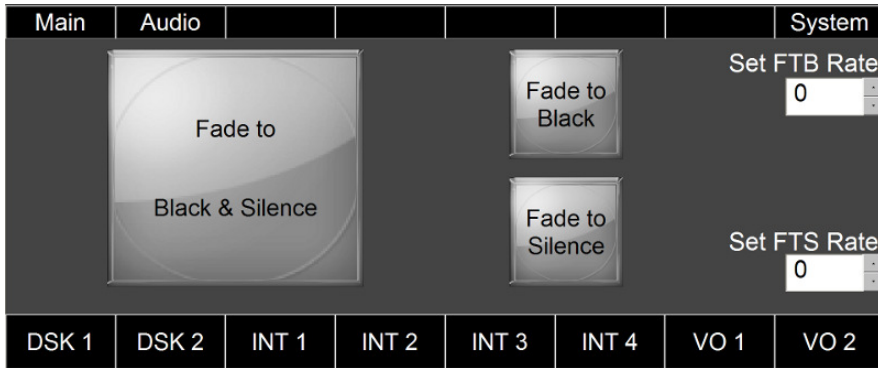


*Figure 3-13* Macro buttons and arm indicator

When the indicator area above the macro button is lit amber and the macro button is lit, this indicates that the macro is armed. When the indicator button is black and the button is off this indicates that the macro is not armed. Having armed a macro the macro action is carried on the Imagestore when the Take button is pressed.

### 3.6.5 Fade to black / silence

Pressing the Fade button to the right of the macro buttons will display the following panel.



*Figure 3-14* Fade to black / silence panel

From this panel all keyers can be faded to black and/or all voice-overs to silence. The rotaries on the right-hand side can be used to define the fade rates for the keyer and voice-over fades. A fade rate of zero indicates a cut transition. The button under the Fade label lights up red whenever keyers are faded to black.

Note: Fading to black / silence is considered to be an emergency measure and as a result these options are not part of the standard arm and take operation. Selecting these options will immediately fade the keyers to and from black, and the voice-overs to and from silence.

### 3.6.6 Arming multiple events on a Take

It is possible to arm any combination of keyers, voice-overs and macros. A complex transition effect can be created by arming these elements and pressing the Take button. This means that any arm action on any of these elements will start simultaneously.

### 3.7 Loading media into a keyer

To load media into a keyer the media browser panel must be displayed. To do this press on either the icon showing the media in the keyer or the DSK arm status label below. This will open the media browser for the appropriate keyer selected.



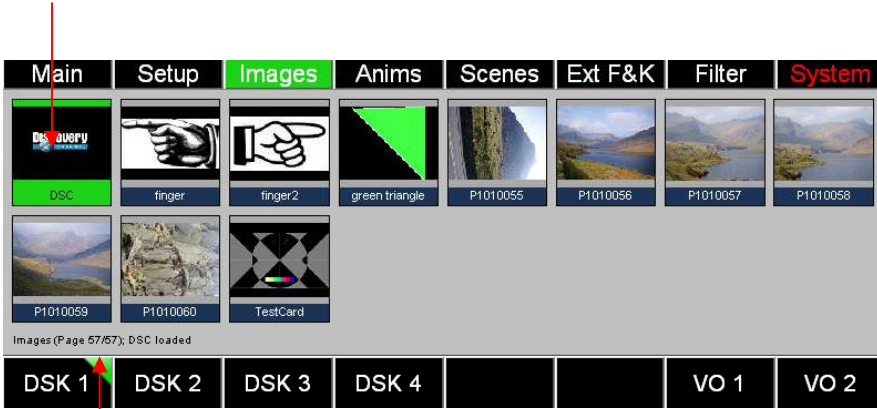
Press anywhere in this region  
to open the browser for DSK 1

**Figure 3-15** Indication of what to select to open media browser.

The media browser panel is shown in figure 3-16. When the media browser is opened, if media is loaded into the keyer, the browser will scroll to display the current icon for the media selected. The background for the icon is green to indicate that this is the media loaded into the current keyer.

Note : The media browser keeps itself up-to-date with media on a controlled device each time a channel is selected: Updating may take a noticeable amount of time for many pieces of media ( >200 ).

Indicator to show that this media is loaded into the keyer



Indicator showing which keyer the media selector is working on

**Figure 3-16** Media Browser panel

For most keyers there are three types of media which can be loaded. These are images, animations and scenes. Alternatively the 'Ext F&K' tab allows the selection of an external fill and key input for the selected keyer.

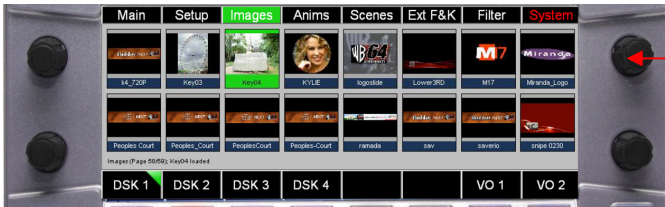
The exceptions to this are:

- An Intuition which only allows scenes to be loaded and consequently only shows the Scenes tab.
- An LGK-3901 which only allows media to be loaded into two of its keyers and for the other three keyers to be assigned to fill and key inputs, so once media is loaded into two keyers selecting another keyer will only allow the selection of fill and key inputs.
- A DSK-3901 which only allows fill and key inputs to be associated with its keyers.



With any of these exceptions only the allowed options will be accessible in the media browser.

To select an item from the media browser to load into the keyer just press on the icon on the touchscreen. The background for the icon will initially turn amber to indicate that the media is loading and then turn green to indicate that the media is loaded into the keyer. If the background turns red this indicates that the media failed to load into the keyer.



Rotary control for scrolling the media up or down

**Figure 3-17** Media browser with control

To scroll the media up or down rotate the top right hand rotary control as shown in figure 3-17.

To switch between browsing media for images, animations, scenes and external fill and key press the buttons above the labels at the top of the display.

### 3.7.1 Filter

On devices with a lot of media it is possible to enter a search string so that only the media containing this string shall be displayed in the browser. To enter the string press the button above the label marked ‘Filter’. This will display the Filter panel as shown in figure 3-18.

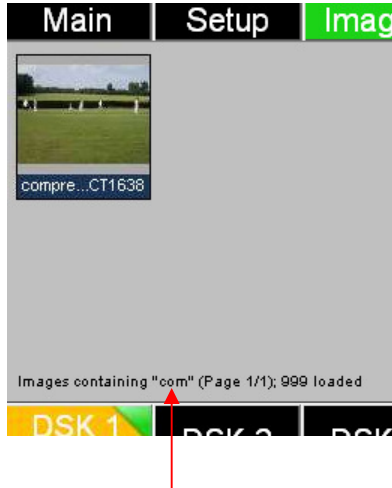


*Figure 3-18* Filter panel

To enter a filter string press the character buttons on the panel. These can only be selected by pressing the touchscreen. The text entered will be displayed in the top bar of the Filter panel. Having typed in the search string, press the OK button. This will close the Filter panel and then initiate a search for media containing the string typed in. The search string is not case sensitive and will match anywhere in the media file name.

Pressing Cancel will clear the search string and close the Filter panel. If any button on the top row of the panel is pressed whilst in the Filter panel this will have the same effect as pressing the Cancel button. The other buttons on the panel remain active whilst the Filter panel is displayed.

When a search string is active, it is shown at the bottom of the media browser panel as shown in figure 3-19.



Current filter string shown here.

**Figure 3-19** Media panel showing filter string

Once a filter string has been entered this will be retained if the media browser changes to browse media of another type. The filter string will also be retained if another panel is opened. The search string will be retained until another search string is entered or the string is cleared.

### 3.8 Modifying media in a keyer

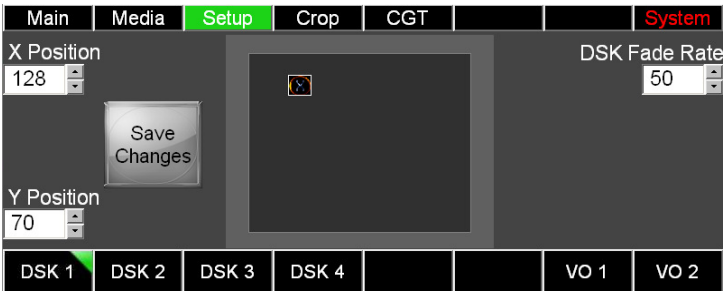
The following modifications can be made to media in a keyer:

1. Position.
2. Cropping.
3. Clip, gain and transparency.

To modify the media select the button above the ‘Setup’ label in the media browser panel. This will open the Setup panel which allows the positioning of media.

#### 3.8.1 Adjusting media position

The media in a keyer can be repositioned horizontally and vertically. Having selected the ‘Setup’ option in the Media panel, the panel shown in figure 3-20 will be displayed.



*Figure 3-20* Adjusting media positioning

To adjust the horizontal position of the media in a keyer, rotate the top left rotary control. This will adjust the horizontal positioning of the media in two pixel steps.

To adjust the vertical position of the media in the keyer, rotate the bottom left rotary control. This will adjust the vertical positioning of the media in two line steps.

The position of the media is previewed in the preview screen in the middle of the panel.

The position adjustment of the media is retained whilst the media is loaded in the keyer. If the media is reloaded into the keyer this positioning information will be lost. If it is required to retain the positioning information then the ‘Save Changes’ button must be pressed. This will permanently save the positioning information with the media so if it is subsequently reloaded into a keyer, the position information will be reused. Please note that selecting the ‘Save Changes’ button will also save any changes made to the media cropping or clip, gain and transparency.

### 3.8.2 Adjusting the media cropping

To adjust the media cropping select the button above the ‘Crop’ label in the media Setup panel. This will open the cropping panel as shown in figure 3-21.



**Figure 3-21** Adjusting the media cropping

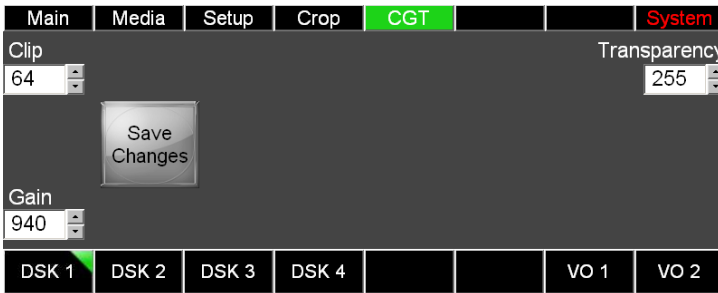
The cropping of the media can be adjusted using all of the rotary controls on the RCP-BR panel. As the cropping is adjusted using these controls, the extent of the cropping on the media will be shown in the preview screen in the middle of the panel. The cropping area will be displayed with a diagonal hatching and the colour of the media is inverted.

The media cropping in this panel is retained as long as the media is loaded into the keyer. If the media is reloaded any cropping information will be lost. If the cropping information is required to be retained when the media is loaded in the future, the ‘Save Changes’ button must be pressed. Please note that selecting this

button will also save any changes made to the media position or clip, gain and transparency.

### 3.8.3 Adjusting the media clip, gain and transparency

To adjust the clip, gain and transparency of the media press the button above the CGT label in either the Setup or Crop panels. Selecting the CGT option will display the clip, gain and transparency panel as shown in figure 3-22.



*Figure 3-22* Adjusting the media clip, gain and transparency

To adjust the clip, gain or transparency turn the appropriate rotary positioned next to the value to be changed.

Once the clip, gain or transparency has been modified these changes will be retained as long as the media is loaded into the keyer. If the media is reloaded into the keyer then these modifications will be lost. To save these changes with the media press the ‘Save Changes’ button. This will save these changes with the media. Please note in addition to saving the clip, gain and transparency values this will also save the positioning and cropping information currently setup for the media.

### 3.8 Audio

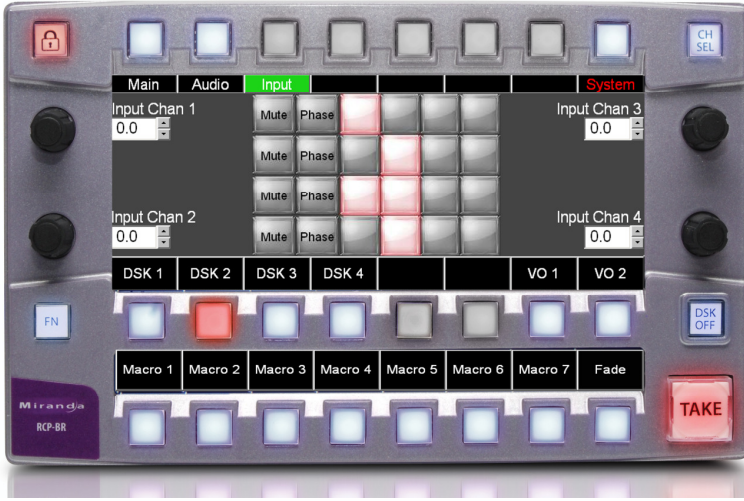
The Audio panel is displayed when the 'Audio' button is pressed or the audio meters are pressed on the touchscreen in the main panel. This Audio button will only be available if the device in the channel is an Imagestore. The audio panel is shown in figure 3-23.



*Figure 3-23* RCP audio output control

To modify the audio output level the top left rotary control can be used to increase or decrease the gain from -99.5 to +28.0dB. The current audio levels on the preview and programme outputs of the Imagestore are shown in the audio meters.

To adjust the audio input settings press the button above the Input label. This will display the audio input panel as shown in figure 3-24.



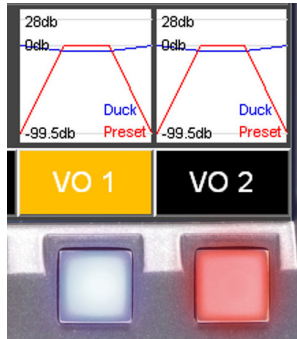
**Figure 3-24** Audio input setup

The rotaries are used to adjust the audio input levels for each of the four input channels. Each of the four input channels can be muted or have its phase changed by pressing the touchscreen. The audio input shuffle can be adjusted by selecting the appropriate shuffle settings in the audio shuffle configuration to the right of the phase buttons.



### 3.9 Voice-overs

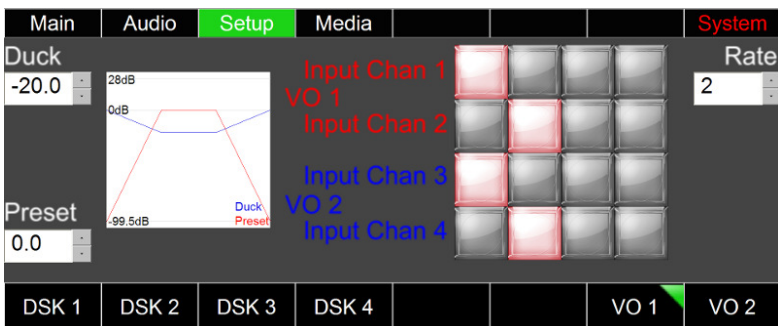
The current voice-over status is shown in the main panel as shown in figure 3-25.



**Figure 3-25** Voice-over status indications on main panel

The voice-over graph shows a representation of the preset and duck levels currently configured for each voice-over. The voice-over label shows the arm state for the voice-over. If this is amber then the voice-over is armed. The button is lit to indicate whether the voice-over is active.

To adjust the voice-over settings press the voice-over graph or label on the touchscreen. This will open the voice-over setup panel as shown in figure 3-26.



**Figure 3-26** Voice-over setup panel

To adjust the duck and preset levels for the voice-over turn the rotaries on the left hand side of the panel. To adjust the voice-over rate turn the rotary on the top right hand side of the RCP-BR panel.

As the duck, preset and rate change, the voice-over graph on the panel will be automatically updated to reflect the current settings.

The voice-over input shuffle can be adjusted using the voice-over shuffle control.

### 3.9.1 Easyplay media browsing

If the RCP-BR panel is connected to an Imagestore 750 or LGK-3901 device running software version 3.1.3<sup>2</sup> or later, then the option to browse for audio media is also available. The audio configuration on the device must be set-up appropriately to support Easyplay on Program and/or Preview outputs. Please contact Miranda support for further details. Selecting the Media option from the top menu displays the audio media on the device as shown in figure 3-27.



**Figure 3-27** Voice-over Easyplay media selection

---

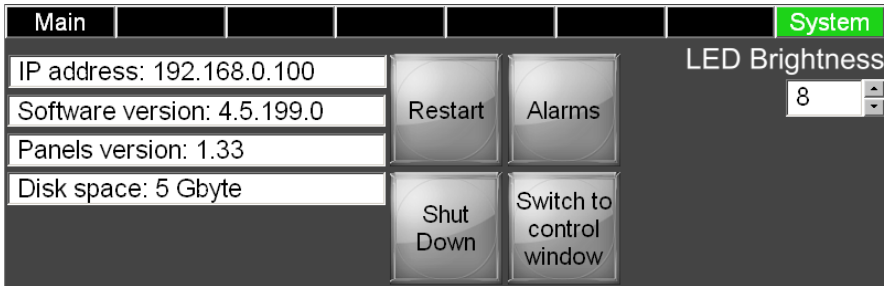
<sup>2</sup> For details about Imagestore 750 / LGK-3901 software 3.1.3, please contact Miranda support.

If Easyplay is configured to be available on both Program and Preview outputs then the “Play Preview” and “Load Preview Only” options are available. These allow media to be loaded and played only on the Preview output of the controlled Imagestore 750 / LGK-3901 device, without affecting the Program output. Media loaded into the Program output is highlighted in green, and media loaded into the Preview output is shown in blue. Media loaded into the Program output starts playing automatically whenever the voice-over is cut up. To play the selected audio on the Preview output, select the “Play Preview” button.

When browsing audio media, you can use the Setup option to return to the voice-over settings menu, and use the Filter option to search for specific media (see section 3.7.1 for further details).

### 3.10 The System panel

The System panel displays information regarding the RCP-BR panel. It also allows for the configuration of the LED brightness, access to alarms and the mechanism for restarting or shutting down the RCP-BR panel. The System panel is shown in figure 3-28 and is opened by pressing the button above the System label at the top right hand of any panel.



**Figure 3-28** System panel

If the System label is lit red, it indicates that one of the devices configured on the RCP-BR panel is alarmed. To find out which device is alarmed press the 'Alarms' button within the System panel.

To adjust the LED brightness turn the top right rotary. This will adjust the brightness of the LEDs, where 1 is the dimmest and 8 the brightest setting.

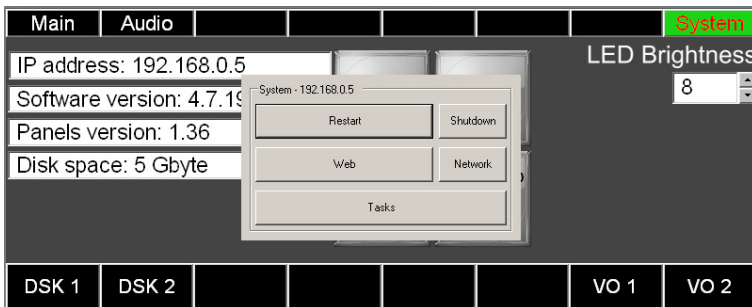
To shut down the unit press the ‘Shut Down’ button. This will then display the options to confirm or cancel the shut down as shown in figure 3-29.



**Figure 3-29** Shut down confirmation

Similarly if the Restart button is pressed it will display the Confirm/Cancel buttons and selecting the Confirm option will restart the RCP-BR panel.

Pressing the ‘Switch to control window’ button will display the control window as shown in figure 3-30.



**Figure 3-30** Control window

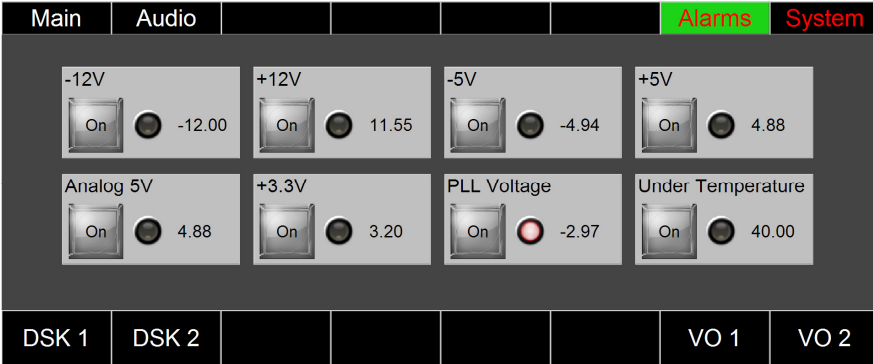
The control window allows the operator to:

1. Access the Windows task manager.
2. View the web interface connected to the RCP-BR panel.
3. Restart or shutdown the RCP-BR. Please note that these can be carried out directly from the System panel.

To close the control window press any area of the touchscreen outside the control window.

### 3.11 Alarms

Pressing the ‘Alarms’ button in the System panel will display the Alarms panel.

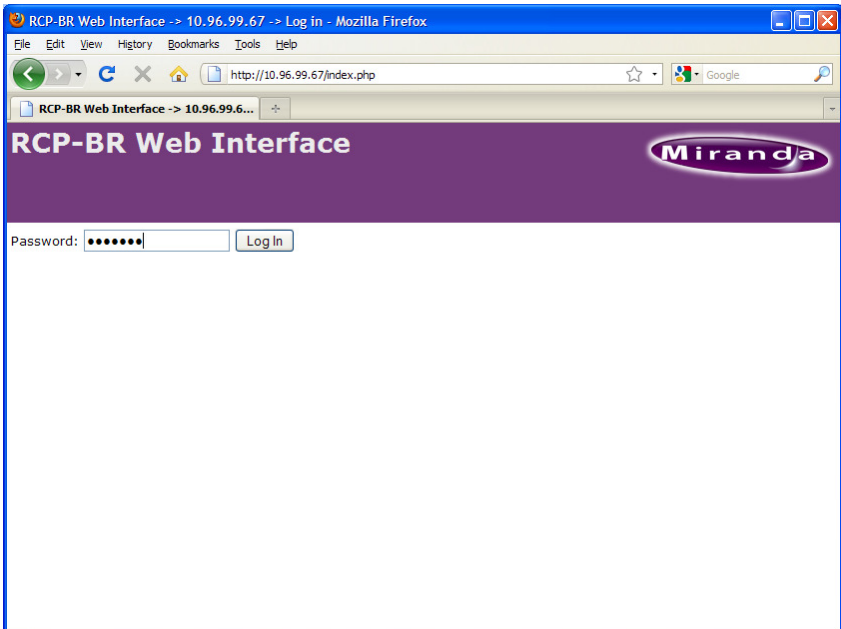


**Figure 3-31** Alarms panel

The panel shows the device alarms for the Imagestore, LGK or DSK device for the current channel. If multiple channels are ganged, then the alarms for the master channel are shown (see section on *Channel ganging* for more details). If the current channel only has an Intuition-type device, then no alarms will be shown because Intuitions currently do not provide any alarm information. If any of the device readings fall outside the expected range then a red LED will highlight the potential problem. An alarm can be turned on or off by toggling the On button within the appropriate alarm box.

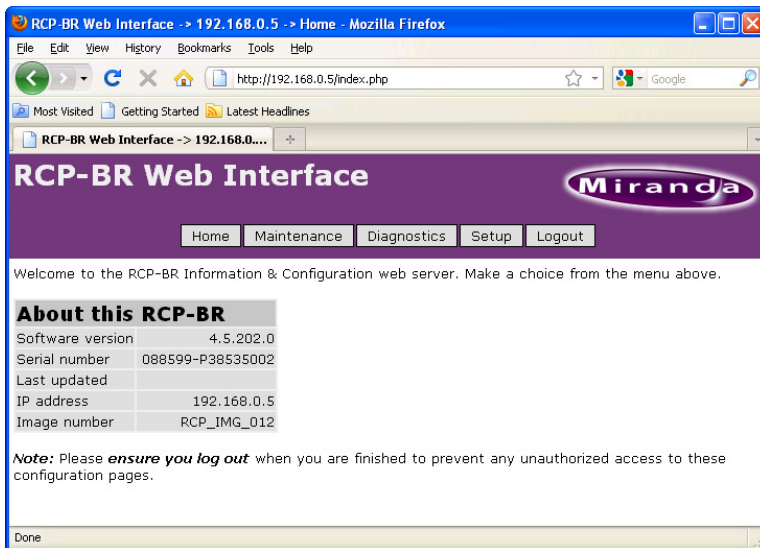
## 4 The web interface

The RCP-BR panel's web interface can be used for maintenance and setup of the unit. To access the web interface start-up a web browser on a computer that has network access to the RCP-BR panel. Type in the IP address or the hostname of the RCP-BR panel into the location bar of the browser. This will display the login page for the RCP-BR panel as shown in figure 4-1.



*Figure 4-1* Web interface log-in page

To login, type in the password 'miranda'. This will open the home page as shown in figure 4-2.



**Figure 4-2** Web interface home page

The web interface home page shows the information about the RCP-BR panel:

- The current software version.
- The serial number if one is defined.
- The date that the software was last updated.
- The IP address of the RCP-BR panel.
- Image number. Note that this refers to the original factory image number and so is not affected by software upgrades.

From the home page the following options can be selected:

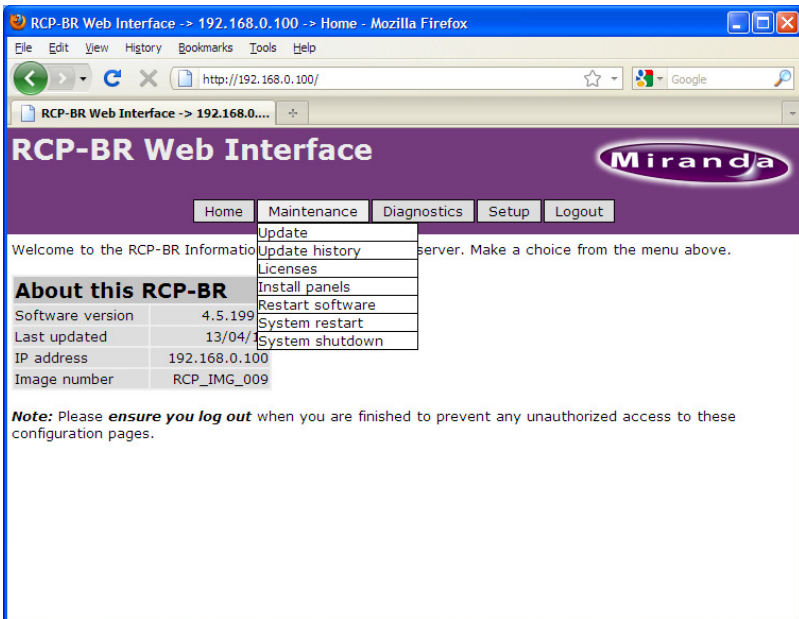
- Maintenance
- Diagnostics
- Setup
- Logout



## 4.1 Maintenance

The maintenance option in the web interface allows for the following actions:

- Update software
- Show update history
- Licenses
- Install panels
- System restart
- System shutdown

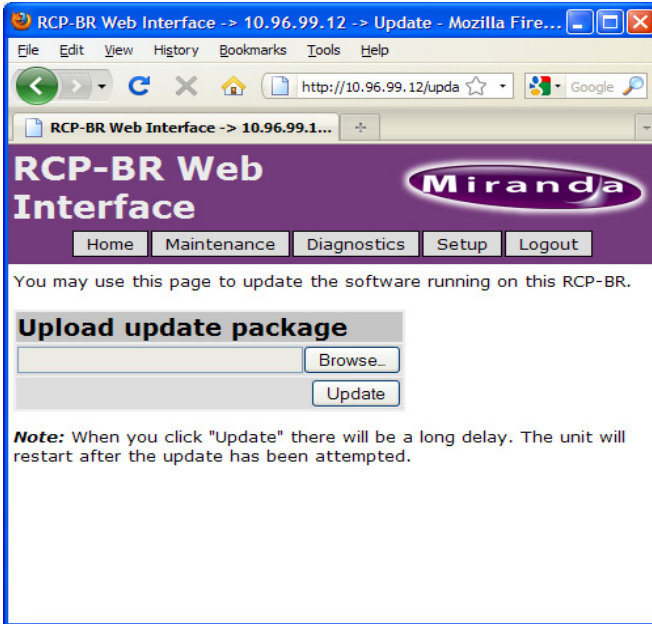


*Figure 4-3* The web interface maintenance options

To display the drop down list of options move the mouse to point to the 'Maintenance' box and the drop down list will appear. Move the mouse to the required option in the list and press the left mouse button.

### 4.1.1 Update

Having selected the update option from the maintenance drop down list the update pane for the web interface will be shown.

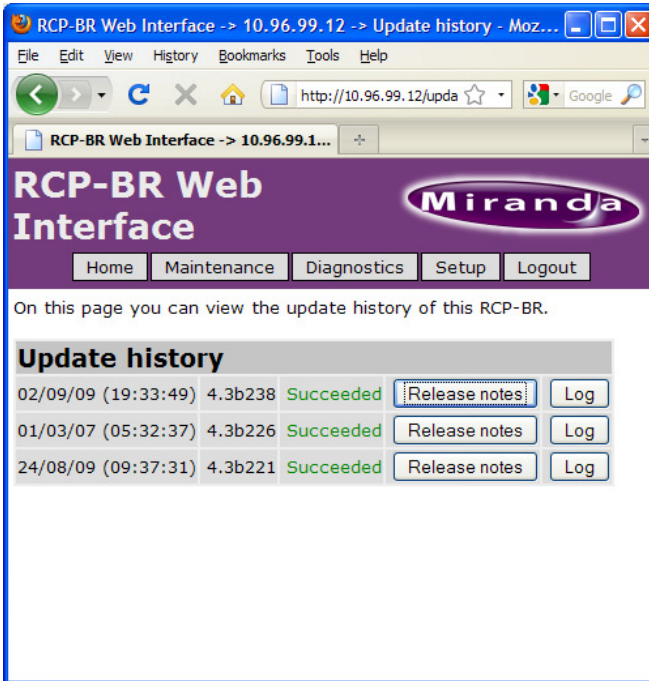


*Figure 4-4* Web interface software update

Firstly the update package needs to be selected by browsing to the file by clicking on the Browse option. Having selected the update package press the Update button. This will initiate the update of the RCP-BR panel. It is important to note that once the update button is pressed there will be a long delay whilst the process of updating the RCP-BR panel is carried out. At the end of the update process the RCP-BR panel will automatically restart.

## 4.1.2 Update history

Selecting the update history option will display the page shown in figure 4-5.



*Figure 4-5* Update history

This view will display a list of all the software updates carried out on the panel. If any of the 'Release notes' buttons are pressed then a window showing the appropriate release notes for the RCP-BR will be displayed. If the 'Log' button is pressed then the log for installation process associated with the release is shown.

### 4.1.3 Licenses

This page displays the licenses that are currently installed on the RCP-BR unit. Please contact customer support with the Customer Id displayed on this page if you require additional licenses.

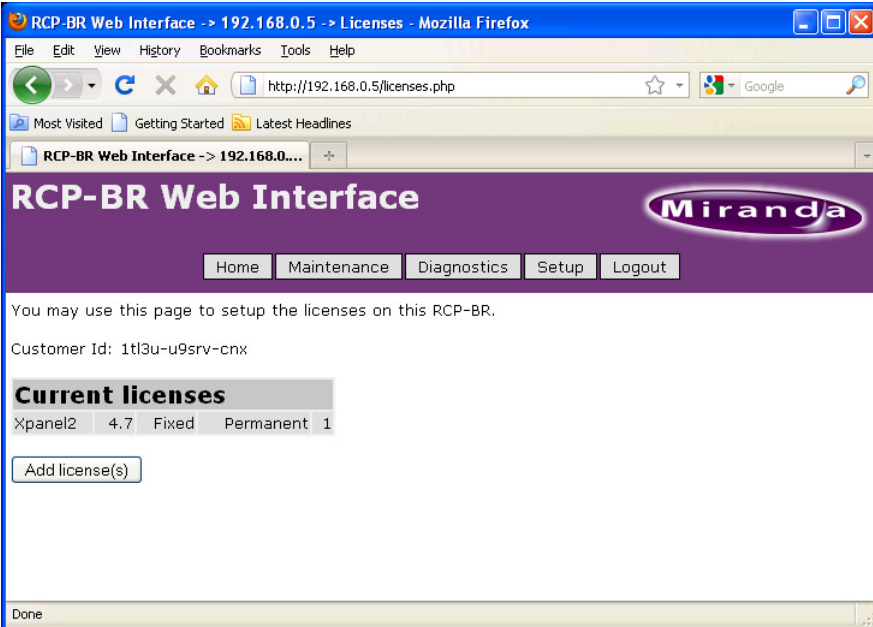


Figure 4-6 Licenses

## 4.1.4 Install panels

When an update occurs on the unit the update process will sometimes contain newer versions of the panels used on the RCP-BR panel. These panels will not automatically replace the panels on the RCP-BR panel as these have the ability to be modified by the user. To update to the latest panels installed on the RCP-BR panels select the option ‘Install panels’.



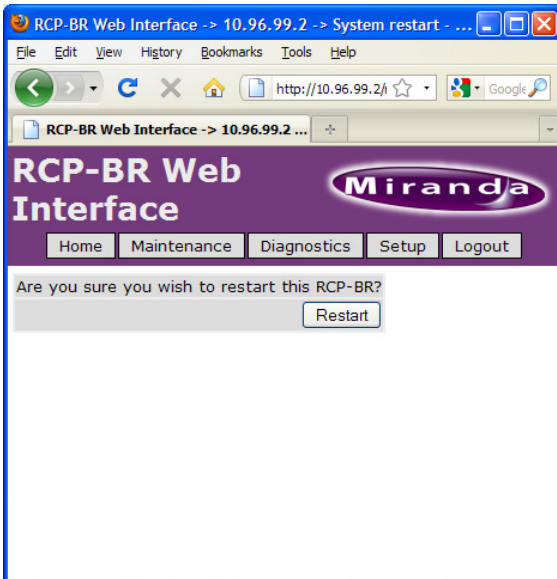
*Figure 4-7* Install panels option

To install panels check the box beside ‘Check here to confirm this is OK’ and then press the ‘Install’ button.

On the RCP-BR panel the application software will close and a progress bar will be displayed. At the end of this the unit will restart.

### 4.1.5 System restart

It is possible to restart the RCP-BR panel from the web interface. To restart the unit select ‘System Restart’ from the drop down list.

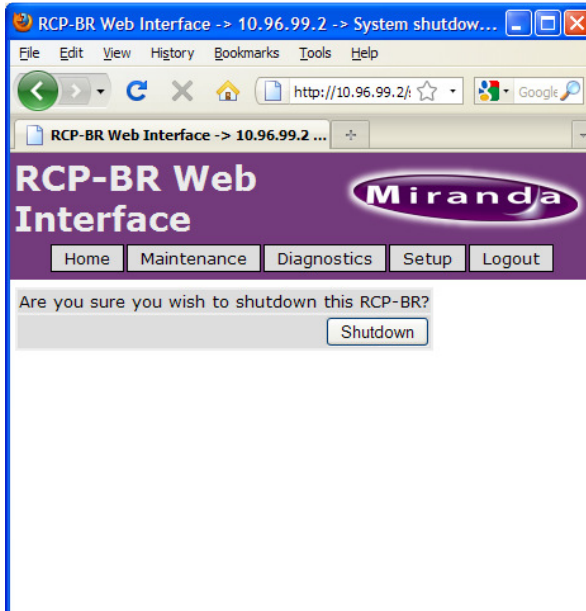


**Figure 4-8** RCP-BR panel restart

To restart the unit press the ‘Restart’ button.

## 4.1.6 System shutdown

To shutdown the RCP-BR panel from the web interface select the ‘System shutdown’ option from the maintenance drop down list. This will show the shutdown page of the web interface.



*Figure 4-9* RCP-BR panel shutdown

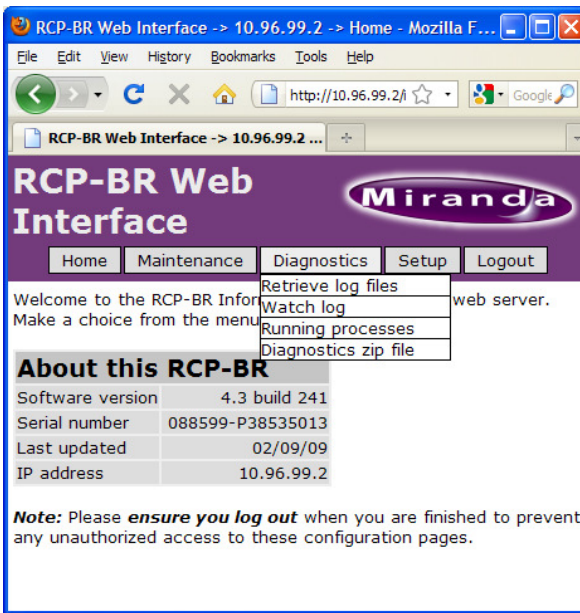
To shutdown the RCP-BR panel press the ‘Shutdown’ button.

## 4.2 Diagnostics

The diagnostics section of the web interface allows for the following diagnostic operations to be carried out:

1. Retrieve log files.
2. Watch log.
3. Show running processes.
4. Download diagnostic zip file

To select the diagnostic option point the mouse at the 'Diagnostics' box. This will show the drop down shown in figure 4-10.



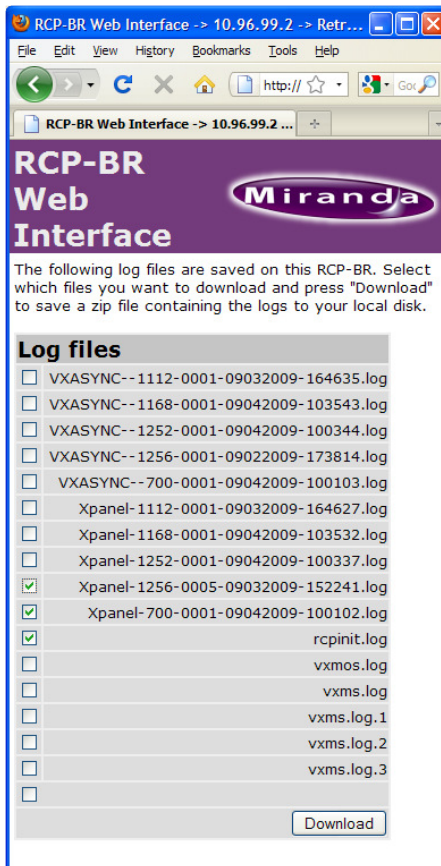
**Figure 4-10** Diagnostic option selection.

Move the mouse cursor down over the list of diagnostic options and left click to select the required option.



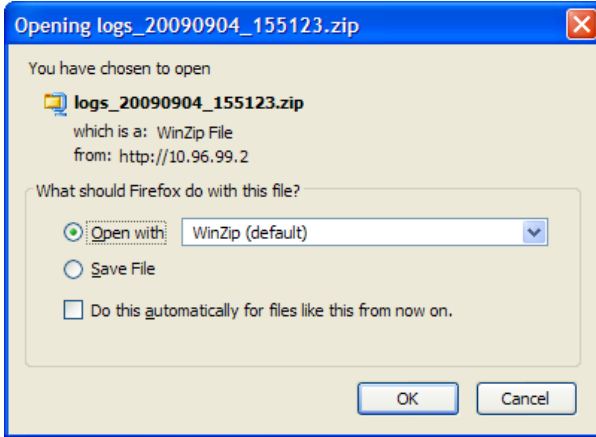
## 4.2.1 Retrieve log files

Selecting the ‘Retrieve log files’ option allows a selection of the log files on the unit to be selected for download. The log files on the RCP-BR panel are displayed in a list as shown in figure 4-11.



**Figure 4-11** Selection of log files to download

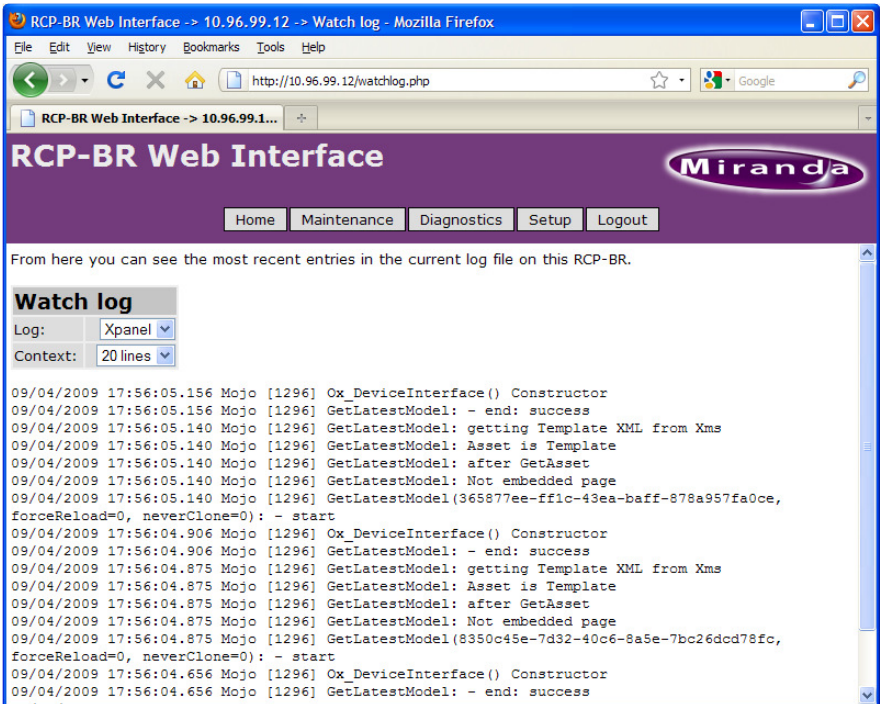
To select the log files to download click in the box at the left side of the log file name. This will display a green tick in the box. Having selected all the log files which are required for download press the 'Download' button. This will display the option to open or to save the logs.



**Figure 4-12** Downloading log files

## 4.2.2 Watch log

Selecting the ‘Watch log’ option from the diagnostic list will show a live updating list of the log file from the RCP-BR panel as shown in figure 4-13.

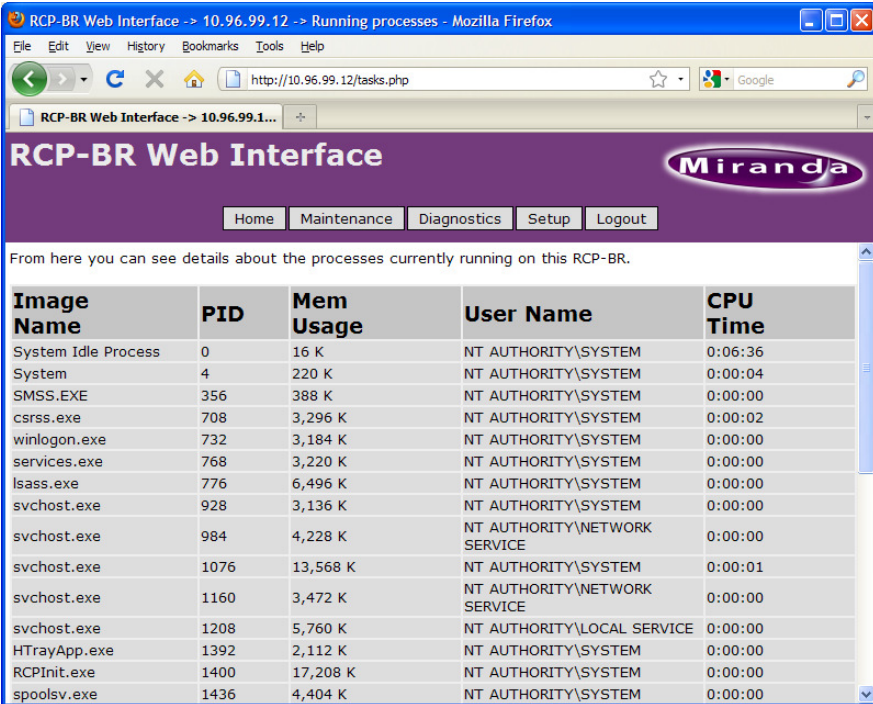


**Figure 4-13** Watch log

By default the Xpanel logs are shown, but the XMS logs can also be watched. The number of log lines can be changed from 20 to 10 or 40 lines.

### 4.2.3 Running processes

By selecting the running processes option from the diagnostics list a continuously updating display of the current processes on the RCP-BR panel is shown.



The screenshot shows a web browser window titled "RCP-BR Web Interface -> 10.96.99.12 -> Running processes - Mozilla Firefox". The address bar shows "http://10.96.99.12/tasks.php". The page header includes the "RCP-BR Web Interface" logo and the "Miranda" logo. Below the header are navigation buttons: "Home", "Maintenance", "Diagnostics", "Setup", and "Logout". The main content area contains the text: "From here you can see details about the processes currently running on this RCP-BR." Below this text is a table with the following data:

Image Name	PID	Mem Usage	User Name	CPU Time
System Idle Process	0	16 K	NT AUTHORITY\SYSTEM	0:06:36
System	4	220 K	NT AUTHORITY\SYSTEM	0:00:04
SMSS.EXE	356	388 K	NT AUTHORITY\SYSTEM	0:00:00
csrss.exe	708	3,296 K	NT AUTHORITY\SYSTEM	0:00:02
winlogon.exe	732	3,184 K	NT AUTHORITY\SYSTEM	0:00:00
services.exe	768	3,220 K	NT AUTHORITY\SYSTEM	0:00:00
lsass.exe	776	6,496 K	NT AUTHORITY\SYSTEM	0:00:00
svchost.exe	928	3,136 K	NT AUTHORITY\SYSTEM	0:00:00
svchost.exe	984	4,228 K	NT AUTHORITY\NETWORK SERVICE	0:00:00
svchost.exe	1076	13,568 K	NT AUTHORITY\SYSTEM	0:00:01
svchost.exe	1160	3,472 K	NT AUTHORITY\NETWORK SERVICE	0:00:00
svchost.exe	1208	5,760 K	NT AUTHORITY\LOCAL SERVICE	0:00:00
HTrayApp.exe	1392	2,112 K	NT AUTHORITY\SYSTEM	0:00:00
RCPInit.exe	1400	17,208 K	NT AUTHORITY\SYSTEM	0:00:00
spoolsv.exe	1436	4,404 K	NT AUTHORITY\SYSTEM	0:00:00

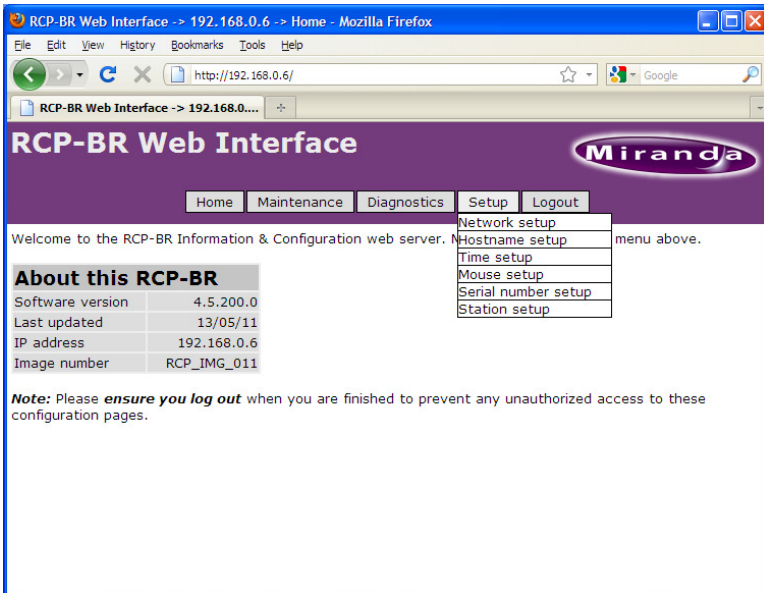
**Figure 4-14** Display of running processes on RCP-BR panel

### 4.3 Setup

The web interface Setup option allows the setup of the following features:

- Network
- Hostname
- Time
- Mouse
- Serial number
- Station

To select the Setup option point the mouse at the 'Setup' box. This will drop down the Setup list as shown in figure 4-15.

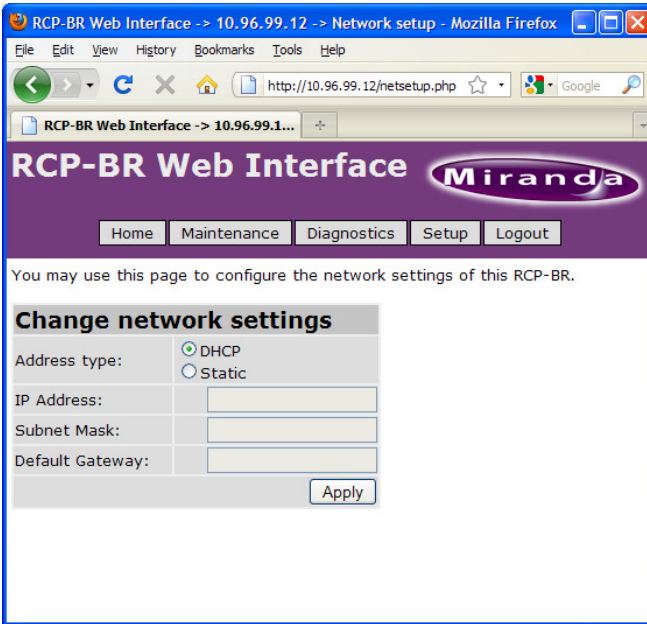


*Figure 4-15* Web interface setup selection

Move the mouse cursor down over the list of setup options and left click to select the required option.

### 4.3.1 Network setup

The network of the RCP-BR panel can be setup to either obtain its network settings automatically via DHCP or to manually enter a static IP address<sup>3</sup>. The interface for modifying the network settings is shown in figure 4-16.



*Figure 4-16* Network setup

By default the RCP-BR panel uses the DHCP setting. To change this select either the 'DHCP' or 'Static' radio buttons and then enter the IP Address, Subnet Mask and Default Gateway. Having carried out the appropriate changes press the 'Apply' button to update the network on the RCP-BR panel. It is not necessary to restart the RCP-BR panel for these settings to come into effect.

---

<sup>3</sup> Note : The Default Gateway **must not** be set to 0.0.0.0

### 4.3.2 Set hostname

Selecting the ‘Set hostname’ option from the setup list allows the hostname of the RCP-BR panel to be changed.

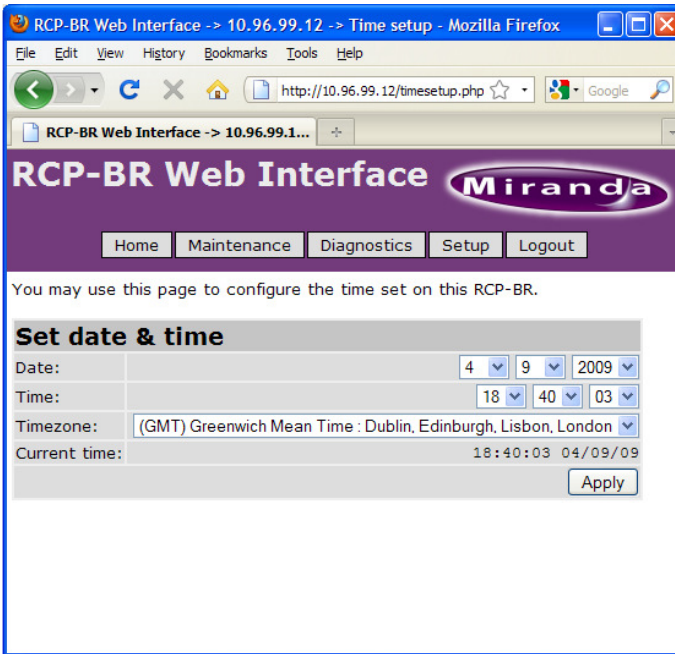


*Figure 4-17* Changing the RCP-BR hostname

The new hostname can be typed into the text box and then the ‘Apply’ button is pressed. It is important to note that selecting ‘Apply’ will automatically restart the RCP-BR panel.

### 4.3.3 Time setup

Selecting the ‘Time setup’ option on the web interface allows the time, date and time zone to be modified on the RCP-BR panel.



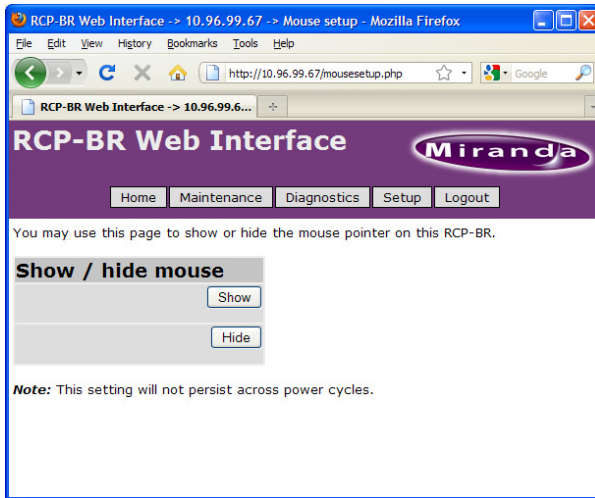
**Figure 4-18** Setup of time and date on the RCP-BR panel

When the date, time and time zone values have been setup correctly, press the ‘Apply’ button. When this change is made the time and date on the RCP-BR panel will be updated without the requirement to restart the unit.



### 4.3.4 Mouse setup

By default the mouse pointer on the RCP-BR panel is turned off. If it is required to display the mouse then this can be enabled in the 'Mouse setup' page.

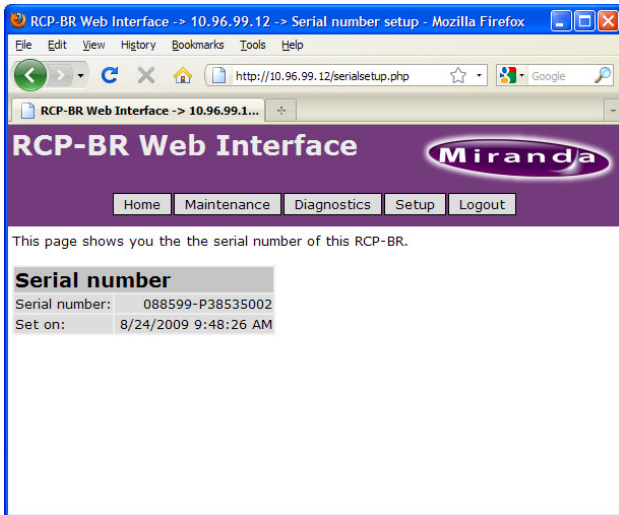


**Figure 4-19** Mouse pointer show/hide on the RCP-BR panel

The mouse pointer will be turned on or off as soon as the 'Show' or 'Hide' buttons are selected. Please note that when the unit is restarted the mouse pointer will always revert back to being hidden.

### 4.3.5 Serial number

Selecting the ‘Serial number setup’ option in the Setup list will display the current serial number and when this was setup on the RCP-BR panel.



*Figure 4-20* Display of the RCP-BR panel serial number

### 4.3.6 Station

Station setup is an essential step in getting an RCP-BR panel configured for operation. As a result, this operation is covered earlier in section 2.3.

## 5 Installation

This section outlines the electrical, mechanical and environmental aspects of the RCP-BR unit.

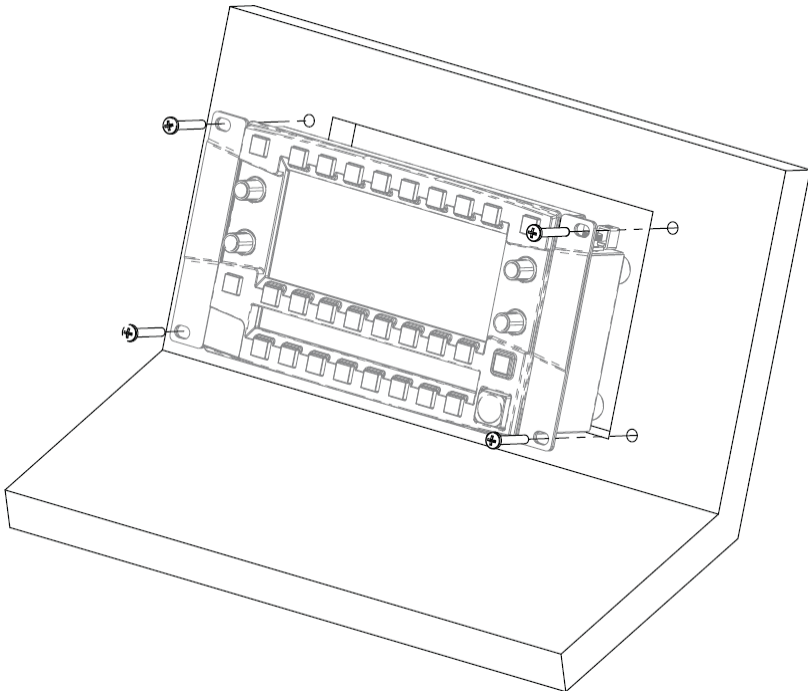
### 5.1 Mounting

RCP-BR ships with both “ears” and “30 degree desk-mounting” brackets.

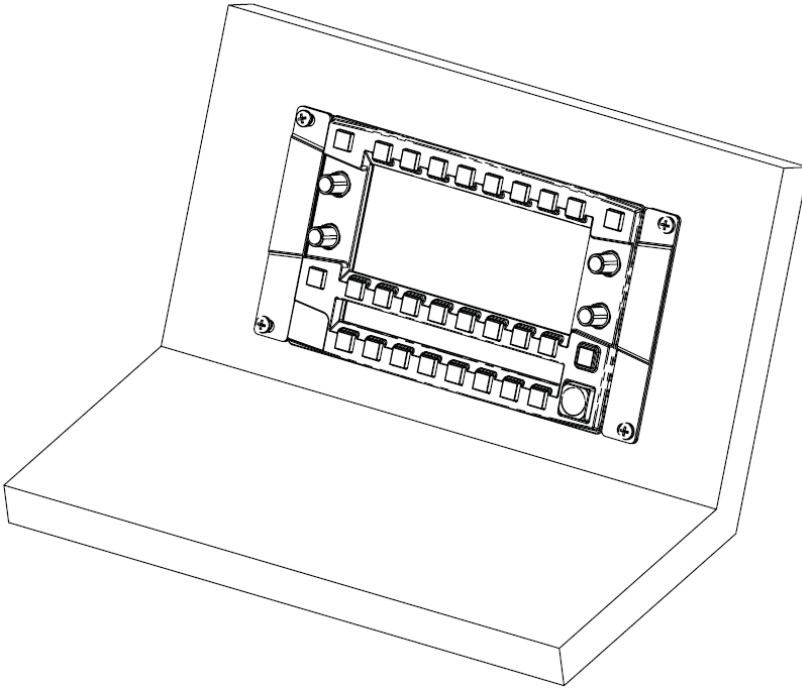
Also available and sold separately:

- Rack-mount kit ( order code RCP-BR-RM-KIT, for 19” rack mounting )
- Desk-mount kit ( RCP-BR-DM-KIT, desk-mounting 60 degree brackets)

#### 5.1.1 Mounting with ears

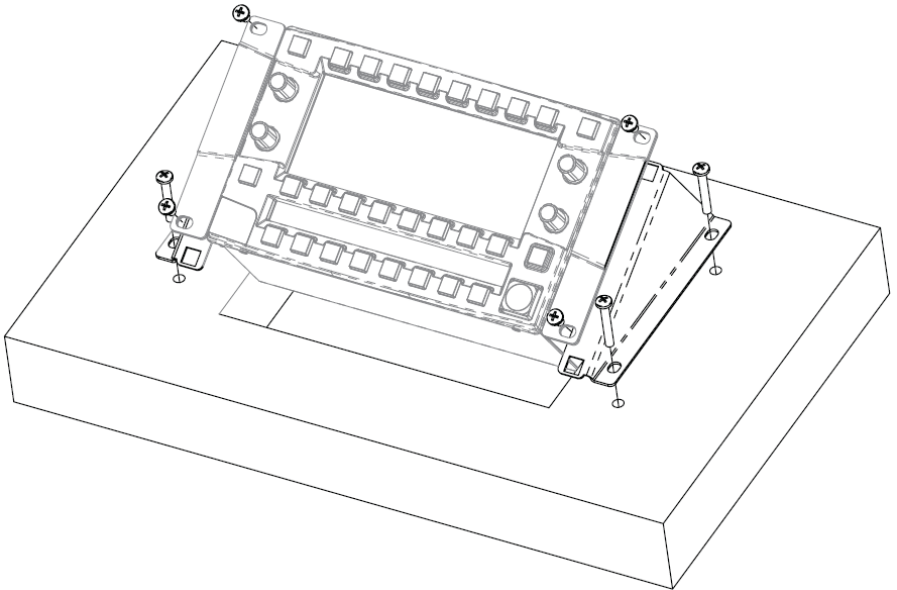


*Figure 5-5-1* Mounting with ears - assembly

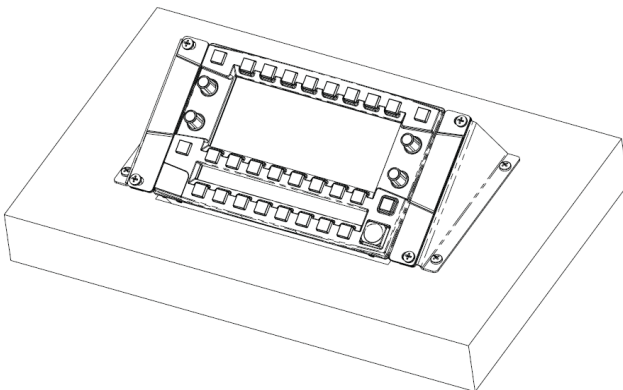


**Figure 5-5-2** Mounted with ears

### 5.1.2 Mounting with 30 degree brackets



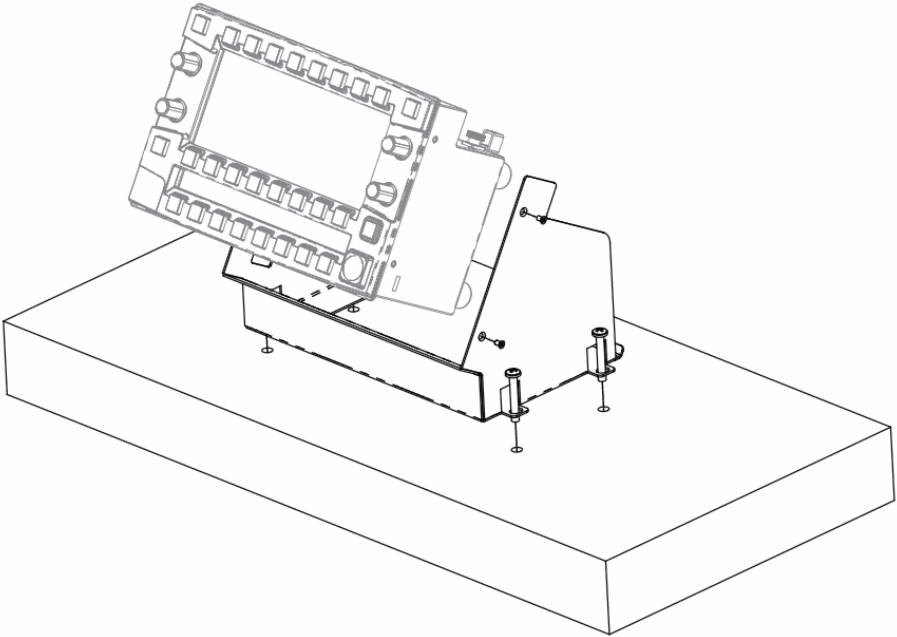
*Figure 5-5-3* Mounting with 30 degree bracket



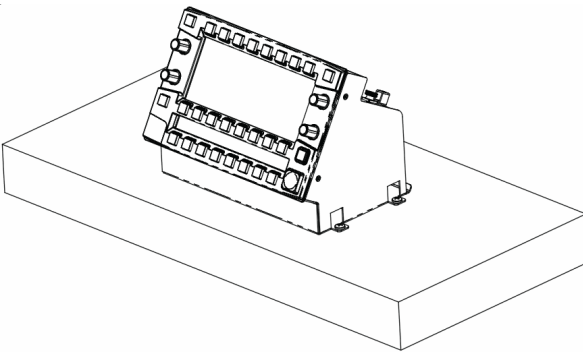
*Figure 5-5-4* Mounted with 30 degree bracket

### 5.1.3 With 60 degree Desk-Mounting kit, RCP-BR-DM-KIT

The 60 degree Desk-Mounting Kit is sold separately - order RCP-BR-DM-KIT



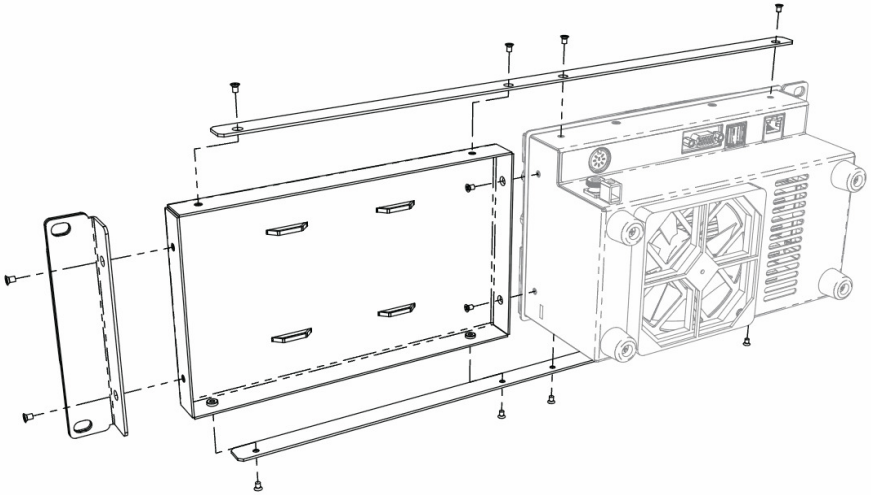
*Figure 5-5-5* Mounting with 60 degree Desk-Mounting Kit - assembly



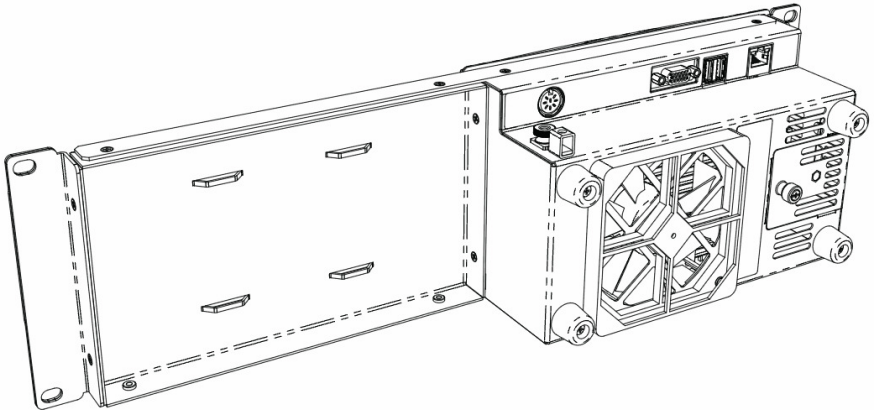
*Figure 5-5-6* Mounted with 60 degree Desk-Mounting kit

### 5.1.4 With Rack-Mounting kit, RCP-BR-RM-KIT

The Rack-Mounting Kit is sold separately – order code RCP-BR-RM-KIT



*Figure 5-5-7* Mounting with Rack-Mounting kit - assembly



*Figure 5-5-8* Rack-Mounted

## 5.2 Ventilation

The RCP-BR unit is forced-air cooled. Air is drawn into the unit through holes at the rear of the unit. Air is exhausted through holes both at the rear and along one side of the unit.

Because air is drawn in from and exhausted back out into the rear, it is important that air-space at the rear of the unit is well ventilated.

Note : It is essential that unit ventilation holes remain clear of obstruction.

Note : It is essential that the air-space at the rear of the unit is well-ventilated.

## 5.3 Power requirements

The RCP-BR unit is DC-powered via the supplied PSU AC power adapter. AC mains voltage 90V-264VAC 47Hz-63Hz.

Power consumption:

RCP-BR unit	40W DC max.
RCP-BR unit & AC adapter	50W max.



## 5.4 RCP-BR rear connections

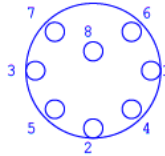
### 5.4.1 Summary

The RCP-BR rear connections are:

Name	Connector	Description
-	-	Metal earthing stud
DC power	8-pin DIN	DC power, 12V from supplied power adapter
GPIO	15 way D-type	<p><b><u>This is not a VGA connector</u></b></p> <p>4 opto-coupled GPI in/out*</p> <p>* For later implementation.</p>
USB	2-off USB-A	<p>USB 2.0 connection for:</p> <p>Upgrade stick</p> <p>Keyboard</p> <p>Mouse</p>
Ethernet	RJ45	100baseT

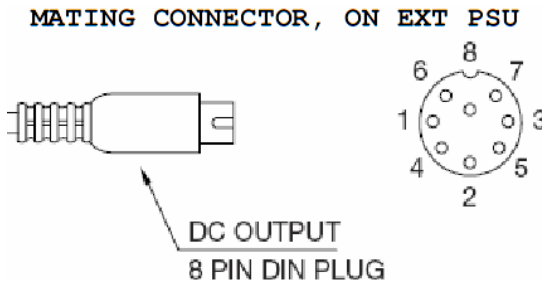
### 5.4.2 DC power connector pinout (8 pin DIN, female)

The connector on the rear of the RCP-BR unit is:



Pin Number	Pin function
1	GND
2	GND
3	+12V
4	GND
5	+12V
6	GND
7	+12V
8	+12V

Diagram of the DC power cable and cable connector of the power adapter supplied with RCP-BR is:



### 5.4.3 GPIO pinout (15-way D-type)

GPIO ports are a future feature.

An active GPIO output is pulled low, ~0.8V. A 5V supply is available, but no more than 500mA should be used. The supply is internally fused.

Pin Number	Pin function
1	GPIO 1
2	GPIO 2
3	GPIO 3
4	GPIO 4
5,6,7,8	Ground Return
9	GPI +5V power, 500mA max, internally fused
10-15	Reserved

Recommend use of Miranda NSH15M 15way terminal adapter with this connector.

**This is NOT a VGA connector**

## 5.5 Mechanical

The RCP-BR unit is a ½ rack-width, 3RU 19” rack unit. It comes with rack mounting ears and 30 degree mounting brackets.

Main unit dimensions:

- Height : 135mm approx.
- Width : 220mm approx. ( excluding “ears” )  
265mm approx. ( including “ears” )
- Depth : 115mm approx. ( maximum )
- Weight : 2.0kg approx. ( RCP-BR unit with “ears” )  
2.5kg approx. ( RCP-BR unit and AC power adapter )
- Cooling : Forced air via internal fan.  
Fan air filter removable without removing RCP-BR casing.

Panel cut-out:

- 213mm x 129mm approx. ( without “ears” )
- 215mm x 129mm approx. ( with “ears” )

## 5.6 Environment

### 5.6.1 Operating

The RCP-BR unit operates in ambient conditions of 5°C to 40°C , where the forced-air cooling temperature is 5°C to 40°C. Humidity 20%–80%, non-condensing.

Note : Temperature of air drawn into unit at rear must be 5°C to 40°C.

### 5.6.2 Storage

The RCP-BR storage temperature is -10°C to +70°C.

## **5.7 Other**

### **5.7.1 RTC battery**

The RCP-BR contains a back-up cell battery (3V CR2032 or equivalent ) for the Real Time Clock and CMOS settings. Should this need replacing, contact Miranda Customer Support and dispose of depleted battery in accordance with local regulations.

### **5.7.2 Compact Flash**

The RCP-BR contains a compact flash which stores all media and program software. This is accessible through a small door in the rear of the unit. Ensure unit is powered down before replacement of Compact Flash. Use only Miranda-supplied Compact Flash.