

Telecast
Fiber Systems, Inc.

New Viper™

Instruction Manual

Telecast Fiber Systems, Inc.
102 Grove Street
Worcester, MA 01605
Tel: 508-754-4858
Fax: 508-752-1520
www.telecast-fiber.com

Telecast Viper

Table of Contents

Laser Safety	ix
Laser Radiation	ix
FCC Part A Notice	ix
CE Warning	ix
Introduction	1
Applications	2
Unpacking	2
Components	3
Portable Mussel Shell Chassis	4
Rack Mount Chassis	4
Removing the Rack Mount Adapters	4
I/O Function Modules	4
Auxiliary I/O Board	5
Wavelength Division Multiplexer	5
WDM Installation	6
Power Systems	7
Internal	7
Battery Pack	7
Audible Alarm	8
External	8
Anton-Bauer	8
Power Connections	8
Input Power Fuse	9
Main Circuit Boards	9
Signal I/O	10
Status Indicators	10
Connector Numbering Conventions	10
Chassis Configuration	11
VIM4	11
VIM8	12
442	13
V800D	14
Signal Connections	15
Audio	15
Video	16

Optical Fiber	16
Transmission Fiber Ports	17
Military Connectors	17
Fiber Cable Runs.....	18
Connecting a Fiber.....	19
Function Modules	20
TX/RX 103: Analog Video.....	21
TX 103 Video Transmitter.....	21
RX 103 Video Receiver.....	21
Return Video	22
TX/RX 259: Digital Video	23
TX 259 Transmitter.....	23
RX 259 Receiver.....	24
TX/RX 292: High Definition Video.....	24
TX 292 Transmitter.....	25
RX 292 Receiver.....	26
TX/RX 280 and TX/RX 380: Digital Audio	26
TX 280 Transmitter.....	29
RX 280 Receiver.....	30
TX/RX 380 Audio Expansion Modules.....	30
TX 380 Transmitter.....	31
RX 380 Receiver.....	31
TX/RX 380 Address Switches	32
TR 260 Transceiver.....	32
The Auxiliary Option.....	33
Auxiliary Submodule Boards.....	33
Mounting the Auxiliary Submodule Board	34
Audio Module Removal	34
Audio Module Installation	34
DATA/CCU	34
TALLY/CALL.....	34
Intercom Modules.....	36
4-Wire.....	36
Clear-Com.....	37
RTS/Telex.....	38
Intercom Module replacement.....	38
Viper Operation	39
Viper Field Reconfiguration	40
Changing the Signal Direction	40
Video.....	40
Audio.....	41

Audio XLR Connectors	41
Module Slot Compatibility	41
Wavelength Division Multiplexing (WDM).....	42
Multiplexing Audio Signals.....	42
Transmitting Audio in One Direction:	42
Transmitting Audio to Multiple Destinations	43
Splitting Auxiliary Signals.....	43
Hardware Requirements	43
Submodule DIP Switch Configuration	44
Accessory List.....	45
Repair.....	45
Operating Characteristics.....	46
Warranty	50

List of Figures

Figure 1. Portable Application	2
Figure 2. VIM8 Internal Configuration	3
Figure 3. Removing the Rack Mount Adapters.....	4
Figure 4. WDM Application	7
Figure 5. Backup Battery Pack.....	8
Figure 6. VIM8 and 442 Main Circuit Board.....	9
Figure 7. Viper 442 Rear Panel.....	10
Figure 8. VIM4 Front Panel	11
Figure 9. VIM4 Rear Panel	11
Figure 10. VIM8 Front Panel	12
Figure 11. VIM8 Rear Panel	12
Figure 12. 442 Front Panel.....	13
Figure 13. 442 Rear Panel	13
Figure 14. V800D Front Panel	14
Figure 15. V800D Rear Panel	14
Figure 16. XLR Connectors on a 442 Rear Panel	16
Figure 17. Tac-4 Cable and Kellems Grip Interconnect	17
Figure 18. Military Connectors and Ox-Frame Reel.....	18
Figure 19. Analog Video Input Schematic.....	21
Figure 20. TX 103 Video Module	21
Figure 21. Analog Video Output Block Diagram	22
Figure 22. RX 103 Video Module.....	22
Figure 23. TX/RX 259 Digital Video Module Set Block Diagram.....	23
Figure 24. TX/RX259 Connections.....	23
Figure 25. TX 259 Digital Video Transmitter Module.....	24
Figure 26. RX 259 Digital Video Receiver Module	24
Figure 27. TX/RX292 Digital Video Module Set Block Diagram.....	25
Figure 28. TX/RX 292 Connections	25
Figure 29. TX 292 Digital Video Transmitter Module.....	26
Figure 30. RX 292 Digital Video Receiver Module.....	26
Figure 31. TX/RX 280 and 380 Module Sets Block Diagram	27
Figure 32. Configuration Options of 280/380 Modules in a 442 or VIM8	28
Figure 33. Signal Flow Schematic of 280/380 Modules	28
Figure 34. TX 280 Dual Digital Audio Transmitter Module	29
Figure 35. TX 280 Audio Transmission Switch Settings.....	30
Figure 36. RX 280 Dual Digital Audio Receiver Module Front Panel.....	30
Figure 37. RX 280 Faceplate Controls.....	30
Figure 38. TX 380 Dual Digital Audio Transmitter Module Front Panel.....	31
Figure 39. RX 380 Dual Digital Audio Receiver Module Front Panel	32
Figure 40. TX/RX 380 Address Switches.....	32
Figure 41. TR 260 Digital Audio Transceiver Front Panel.....	32
Figure 42. DB-9 Data/CCU Configurations.....	35
Figure 43. 4-Wire Intercom Module	36

Figure 44. Clear-Com Intercom Module.....	37
Figure 45. RTS Intercom Module.....	38
Figure 46. 8-Slot Configuration	42
Figure 47. Split Signal Hardware Requirements	44
Figure 48. Split Signal Path.....	45

List of Tables

Table 1. Viper Configurations	1
Table 2. Viper Applications	2
Table 3. I/O Function Modules	4
Table 4. Function Module Compatibility.....	5
Table 5. WDM Connections	7
Table 6. XLR Power Connections	8
Table 7. Audio XLR Pinout	15
Table 8. Military Connections	18
Table 9. Distance Limits by Fiber Type	19
Table 10. I/O Function Modules	20
Table 11. 280 Module Configurations	29
Table 12. TX 280 Input Signal Levels.....	29
Table 13. TX 380 Input Audio Gain.....	31
Table 14. 4-Wire Intercom Connections.....	36
Table 15. Clear-Com 3-Pin XLR Connections	37
Table 16. RTS/Telex 3-Pin XLR Connections	38
Table 17. 4-Slot Audio/Video Module Standard Configuration.....	41
Table 18. 8-Slot Audio/Video Module Standard Configuration.....	41
Table 19. Auxiliary Submodule Board Switch Settings	44
Table 20. Electro-Optical Characteristics.....	46

Laser Safety

WARNING

Some modules in this series may use a Laser Diode transmitter. This paragraph applies only to them.

Class 1 Laser. Do not stare into a connector port or fiber.

Laser Radiation

The unit is a CDRH Class 1 laser device. Although this means it is eye safe, **you must avoid** looking directly at, or staring into, the laser beam located on an ST connector or on the end of a fiber.

Infrared radiation is produced at the fiber connection port on the rear of the unit and at the end of unterminated optical fibers that are attached to this port. Avoid long, direct exposure to the light that comes from these sources.

Do not enable the laser when there is no fiber attached to the fiber connection port.

Do not attempt any type of service to this instrument other than so instructed in this manual. Refer servicing to Telecast Fiber Systems, Inc.

FCC Part A Notice

This equipment has been tested and found to comply with the limits for a Class A digital device, pursuant to Part 15 of the FCC rules. These limits are designed to provide reasonable protection against harmful interference when the equipment is operated in a commercial environment. This equipment generates, uses and can radiate radio frequency energy and, if not installed and used in accordance with the instruction manual, may cause harmful interference to radio communications. Operation of this equipment in a residential area is likely to cause harmful interference in which case the user will be required to correct the interference at his own expense.

CE Warning

This is a Class A product. In a domestic environment this product may cause radio interference, in which case the user may be required to take adequate measures.

Introduction

The Telecast Viper is a modular, user-reconfigurable fiber optic communication system for the field acquisition of video and audio signals. Plug-in I/O modules inside the Viper chassis transmit electrical signals from a remote location by converting them to optical signals and transmitting them over fiber at distances of 20 km or more. The signals are then reconverted back to standard electrical signals at a base location, such as a production vehicle or transmitter. Return signals can also be transmitted from the base site back to the remote location.

Fibers connect the transmitter (TX) module with its corresponding receiver (RX) module. A Wavelength Division Multiplexer (WDM) option, available from Telecast, combines two modules onto a single fiber, thus reducing by one-half the number of fibers needed.

Modules are housed in two factory configured modular chassis units which contain the electronics and electro-optics modules. Viper models are housed in Telecast's portable *Mussel shell* chassis or mounted in a standard 19 inch rack.

Portable and rack mount units are electrically compatible and can operate together as transmitter and receiver. Each chassis is equipped with an alarmed internal battery backup. Standard chassis configurations are listed in Table 1, and are discussed in detail beginning on page 11.

This manual describes the system's five standard chassis configurations and the internal plug-in function modules necessary for system operation.

Table 1. Viper Configurations

Chassis	Description
VIM4	Portable, 4-module: <ul style="list-style-type: none"> • 2 analog or digital video cards • 2 dual audio cards • 1 auxiliary connection (optional)
VIM8	Portable 8-module: <ul style="list-style-type: none"> • 4 analog or digital video cards • 4 dual audio cards • Auxiliary and intercom connections (optional)
442	Rack mount, 8-module: <ul style="list-style-type: none"> • 4 analog or digital video cards • 4 dual audio cards • Auxiliary and intercom connections (optional)
V800D	Rack mount, 8-module: <ul style="list-style-type: none"> • 8 analog video cards • No audio or auxiliary connections

Applications

The Viper is suitable for use in both portable and fixed applications such as those listed in Table 2.

Table 2. Viper Applications

Fixed	Portable
Campus Backbone Communications	Electronics News Gathering (ENG)
Studio-Transmitter Links (STL)	Electronic Field Productions (EFP)
CATV Video and Audio Service	Government and Military
Arenas and Stadiums	Local events

The Viper can be used in conjunction with other Telecast products. Figure 1 illustrates a typical portable application. In the figure, the Viper is combined with the Telecast Adder for a high capacity, single cable announce booth connected to an outdoor broadcasting (OB) van at the base location. This configuration supplies 4 video connections and 72 audio connections.

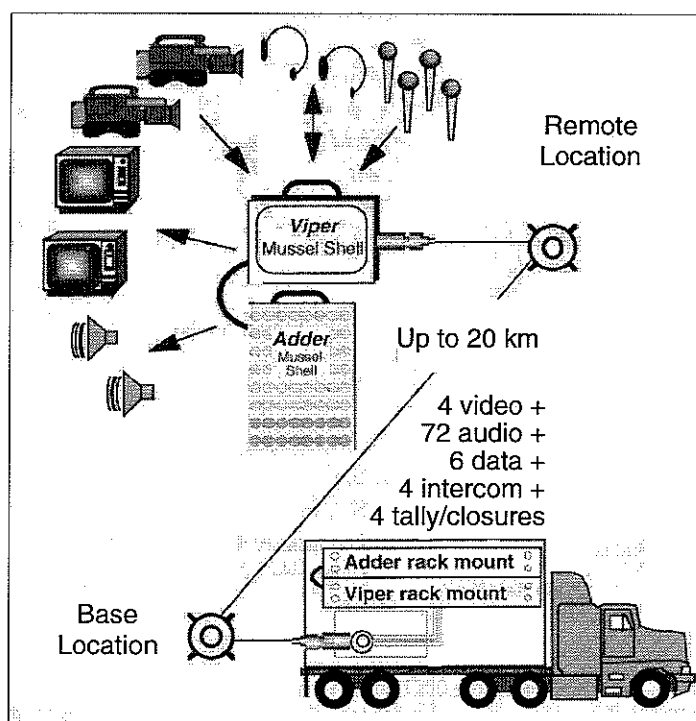

Figure 1. Portable Application

Unpacking

Inspect the units for mechanical damage, and the electrical connectors for bent or damaged pins and latches. Report any damage to the carrier and to Telecast Fiber Systems, Inc.

Note: Leave the protective caps on the optical connectors whenever the fiber is disconnected.

Components

The Viper system consists of TX and RX units involving two rack mount chassis, two portable chassis, or one of each type.

The following components are shipped with the Viper system:

- Two chassis
- External power supplies for each unit
- Protective caps for optical connectors
- Hardware kits for rack mounting the unit (removable for table-top use)

The following components are available from Telecast for use with the Viper system:

- I/O Function Modules (Table 3 on page 4 lists available plug-in modules.)
- Backup battery packs
- Wavelength Division Multiplexers (WDM)
- Optical fibers
- Portable fiber reels with fiber

Figure 2 shows the cover removed from the portable Mussel. Note the internal component assembly and the locations of external signal connectors.

Note: The Viper 442 has the same internal configuration as the VIM8, but is rack mounted.

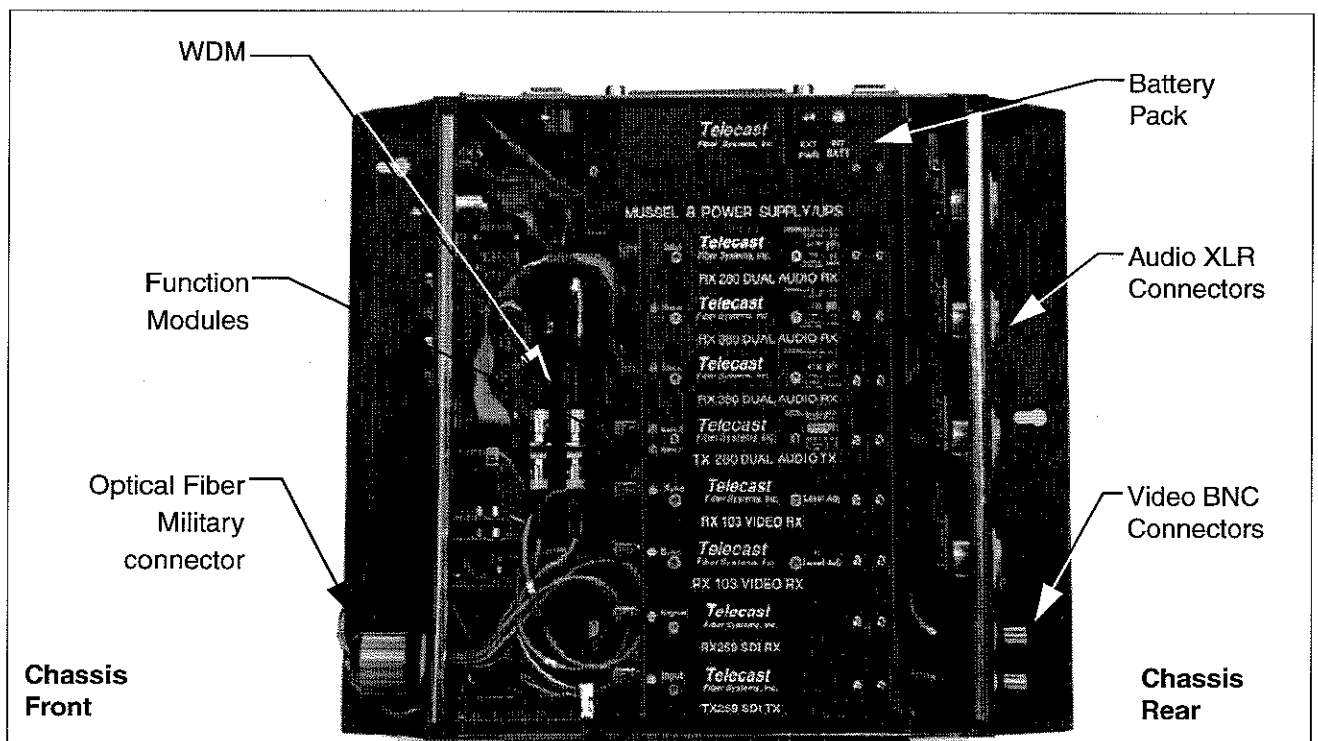

Figure 2. VIM8 Internal Configuration

Portable Mussel Shell Chassis

Models VIM4 and VIM8 are portable units housed in a durable, weather-resistant chassis — the mussel shell. A side mounted handle is provided for easy transport. Extensions on the chassis front and rear provide protection and a key hole for wall mounting. The chassis cover is opened by unlatching four fasteners.

Rack Mount Chassis

Models 442 and V800D are housed in a standard 19 inch electronics rack. To prevent damage to the cables and their connectors, install the units in the intended rack locations prior to making any cable connections.

Removing the Rack Mount Adapters

The rack mount adapters can be removed for table top use and to narrow the profile of the units by removing two #10 Phillips head screws at each adapter (see Figure 3). If you remove the flanges, be sure to store the adapters and screws for future use.

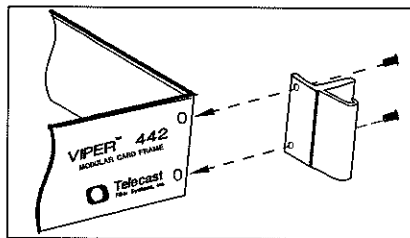

Figure 3. Removing the Rack Mount Adapters

I/O Function Modules

The Viper chassis functionality is determined by the selection of video and audio I/O modules. An auxiliary option submodule for intercom, digital data transmission and switch closure communication can be mounted onto specific audio modules. The Viper supports a number of Telecast I/O function modules and plug-ins. Signal flow is manipulated by the placement and type of I/O modules installed. Table 3 lists the modules available. Detailed descriptions of each module begin on page 20. The Viper can be custom configured offsite by altering the signal flow of the I/O function module installed.

Table 3. I/O Function Modules

Function Module	Transmission Type
TX/RX 103	Analog video module set
TX/RX 259	Digital video module set
TX/RX 292	High Definition 1.5Gb/s video module set
TX/RX 280	Dual channel 18-bit audio module set with auxiliary connection
TX/RX 380	Dual audio expansion module set
TR 260	AES/EBU Digital audio transceiver module

Table 4 provides a listing of Viper chassis and their compatible I/O function modules.

Table 4. Function Module Compatibility

Chassis	Analog Video TX/RX 103	Digital Video TX/RX 259 TX/RX 292	Dual Audio A/B Channel	Intercom	Number of Fibers*	Comments
VIM4 Musel	✓ (2) 103 video connections or ✓ (2) 259 video connections or ✓ (2) 292 video connections		(2) 280 dual audio connections	1 channel; Specify 2- or 4-wire at time of purchase	4	<ul style="list-style-type: none"> • Basic unit; 1 intercom used • Use WDM to reduce the number of fibers by half.
VIM8 Musel	✓ (4) 103 video connections or ✓ (4) 259 video connections or ✓ (4) 292 video connections		(4) 280 dual audio connections	2 auxiliary connections	6	<ul style="list-style-type: none"> • Same use as for the VIM4.
442 Rack	✓ (4) 103 video connections or ✓ (4) 259 video connections or ✓ (4) 292 video connections		(4) 280 dual audio connections	2 auxiliary connections	6	<ul style="list-style-type: none"> • 4 dual audio connections. • Electronic configuration is identical to the VIM8.
V800D Rack	✓ (8) 103 video connections or ✓ (8) 259 video connections or ✓ (8) 292 video connections		None	None	8	<ul style="list-style-type: none"> • Does not support audio or intercom functions. • Use a WDM to reduce the # of fibers by half.

* Normal use operations.

Note: WDM channel selection is made at the time of purchase.

Auxiliary I/O Board

The intercom, data transmission and switch closure are enabled by the addition of an auxiliary I/O circuit board mounted to the last audio module. The units are shipped with DB-9 data connectors on the chassis and a cover over the hole that would accommodate the intercom module, regardless of whether auxiliary functions are ordered. Refer to page 33 for more information.

Wavelength Division Multiplexer

When optical paths are limited and the requirement for signal distribution is high, multiple signals per fiber may be necessary. Fiber capacity can be expanded through the use of the *Wavelength Divisional Multiplexer*, or WDM. The WDM is a passive device that combines and transmits optical signals generated at differing wavelengths onto a single fiber.

Operation with a WDM causes two physical changes:

- Optical loss of 1 to 2 dB for each multiplexed fiber, decreasing the maximum length of fiber that can be used in a particular installation. Table 9 on page 19 lists fiber type/distance limits.
- Optical paths exhibit wavelength sensitivity.

Figure 4 shows an operation using a WDM, where the output of a TX 259 digital video module is multiplexed with the multiplexed audio outputs of a 16 channel Adder and transmitted as a combined signal over one fiber to the receiving unit.

The wavelength of light will determine the angle of refraction through a prism. Since white light is composed of different wavelengths, or *colors* of light, a prism will separate the various wavelengths into color bands. Similarly, various colors of light can be projected into a prism. The output of the prism can be projected into an identical prism to restore the original colors.

The WDM functions in a similar way. A WDM has multiple fiber ports representing the wavelength it will combine on a single fiber. The WDM is a very narrow band device so wavelengths are not interchangeable from port to port.

The WDM has the capacity to handle only two wavelengths of light used in Viper systems. The WDM has three connectors — two for the two wavelengths of light and one for the combined light.

Each leg (optical lead) is numbered, by convention, as follows:

- leg 1 Corresponds to the shorter wavelength of light
- leg 2 Refers to the combined light and serves as the input/output
- leg 3 Refers to the longer wavelength of light

For example, Telecast part number 0713-0001 is a 50 micron WDM for 1300 nm and 1550 nm signals. Leg 1 refers to 1300 nm, leg 2 refers to the combined light, and leg 3 refers to 1550 nm.

Note: Telecast recommends that one WDM port transmit and the other port receive.

Typical Viper systems that use WDMs have one video transmit path and one stereo audio receive path transported on a single fiber. Since Telecast generally manufactures its video transmitters with 1300 nm devices, the video will be sending on leg 1 and the audio (1500 nm) on leg 3 in opposite directions on the same fiber. Alternatively, the video may be received and their audio pair transmitted on a single fiber with the use of a WDM.

To include two video paths on one fiber if the two video paths are in opposite directions, outfit one TX 103 module with a 1300 nm device and outfit another TX 103 module with a 1500 nm device; one end would have a TX 103 (1300 nm) and a RX 103 (1500 nm) and the other end would have a TX 103 (1500 nm) and an RX (1300 nm).

Note: WDMs also are available with legs (optical leads) at 850 nm and 1300 nm.

WDM Installation

The WDM mounts into plastic clips installed directly onto the main circuit board in both the rack and the portable chassis.

The common fiber on the WDM that carries the combined signal is labelled **2**. Input and output fibers are separate and labelled **1** and **3**. When using the WDM, the WDM fiber **2** input yields the corresponding output on fiber **2** of the receiving WDM; see Figure 4 and Table 5.

- Connect fiber 2 (INPUT/OUTPUT) to the rear panel
- Connect fibers 1 and 3 to the modules

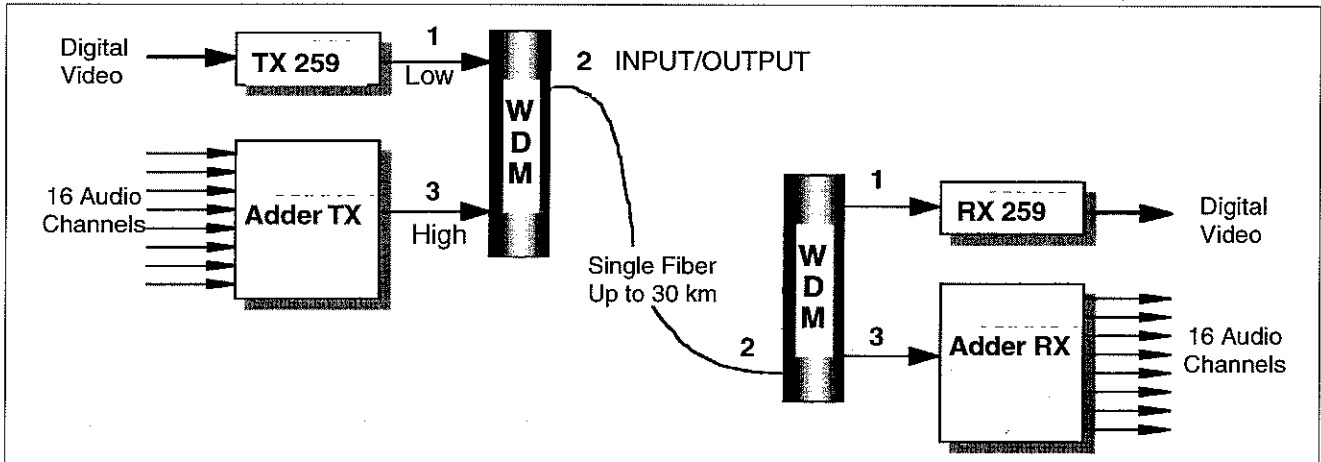

Figure 4. WDM Application

Table 5. WDM Connections

Fiber		Wavelength	
		850/1300 nm	1300/1550 nm
1	Low	850 nm	1300 nm
2	I/O	INPUT/OUTPUT	INPUT/OUTPUT
3	High	1300 nm	1550 nm

Power Systems

Internal

The power source for operation of all Viper models is from either an external unit providing 12 to 24 VDC derived from a line source, or from an external battery such as a camera or automobile battery. Each Viper model has an internal DC/DC converter that conditions and distributes power to the chassis modules. If the external source fails, the Viper draws its power temporarily from the internal battery backup. External power is input via a 4-pin XLR connector on the rear panel. The DC source input is filtered to remove RF noise and for protection from a power surge.

Battery Pack

An internal 10.8 VDC NiCad battery pack provides system power during a battery change or power failure; see Figure 5. The battery pack charges whenever the Viper is connected to an external source providing ≥ 13.8 VDC. Full charge of the battery pack takes 16 hours and provides power for up to 30 minutes in a fully loaded Viper. Viper can operate at < 12 VDC, but this low voltage level depletes the battery charge.

The battery pack is adjacent to slot 8 on all 8-module chassis, and adjacent to slot 4 on the VIM4. Refer to Figure 2 on page 3 for the location of the backup battery pack.



Figure 5. Backup Battery Pack

Two LEDs on the battery pack in a mussel shell (VIM4 or VIM8) or on the front panel of a rack unit (442 or V800D) display the system's power status. In the mussel shell, these LEDs are observable only when Viper is open.

- EXT PWR** Illuminates green when > 12 VDC external power is available to the system.
- INT BATT** Illuminates green when battery charge is sufficient for 10 minutes of emergency operating time, and red when the module is running on external power.

Audible Alarm

The audible alarm switch is the system's only internal switch, located adjacent to the Backup Battery Pack. It is mounted on the main circuit board and wired to a buzzer which sounds whenever external power is lost and the system is operating on battery power. Disable the alarm by opening the chassis cover and switching the audible alarm slide switch on the main circuit board to **OFF**. This procedure is the same for rack units and mussels.

Note: If the audible alarm is disabled prior to operation, the front panel **INT BATT** LED is the only indication that power is being drawn from the *limited power* internal battery.

External

Anton-Bauer

The Anton Bauer Snap-On® external battery pack is an optional power source for the small (VIM4) and large (VIM8) portable chassis. It supplies 12 VDC and can power the chassis for 2 to 5 hours depending on charge status, number of channels installed, and number of channels in use. The battery attaches via an Anton-Bauer Snap-On battery adaptor (model ABAT-MUSLPLATE) which mounts on the cover of the chassis. The battery pack is also available from Telecast.

Power Connections

Table 6 defines the electrical power pinouts on the XLR Switchcraft D4M receptacle located on the rear of the rack mount units and on the front of the portable units.

Table 6. XLR Power Connections

Pin	Signal
1	Ground
2 & 3	No connection
4	+ Input VDC

1. Verify that the front panel power switch is *off*.
2. Insert the 4-pin XLR connector from the Telecast power supply into the 12 to 24 VDC **INPUT POWER** receptacle.
3. Plug the supply into a 120 VAC line.

Input Power Fuse

The Viper requires a 2 Amp SLO BLO power fuse located below the **INPUT POWER** connector. Use the same fuse type if replacement is required.

Main Circuit Boards

There are four different circuit boards available for the Viper system. The main circuit board installed in the VIM8 and the 442 is shown in Figure 6. One switch, the *audible alarm switch*, mounts on the main circuit board of any model Viper. Refer to Figure 6 for its location.

- Small mussel shell main circuit board: 2 video connections and 2 audio connections.
- Large mussel shell and Viper 442 main circuit board: 4 video connections and 4 audio connections.
- V800D main circuit board: 8 video connections only. BNC video connectors require a coax assembly.

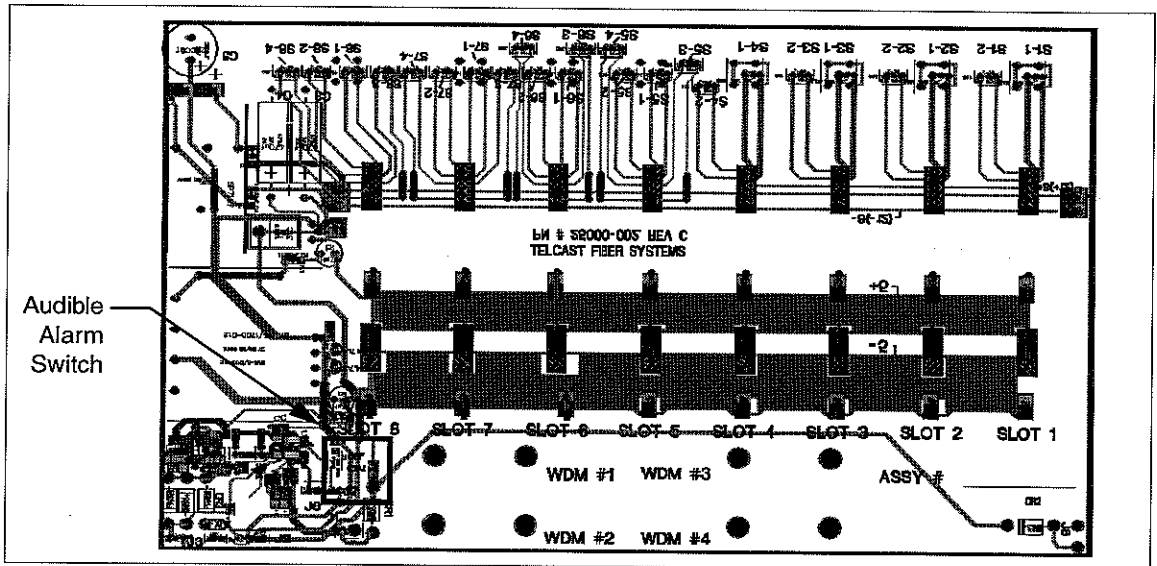

Figure 6. VIM8 and 442 Main Circuit Board

Signal I/O

Your Viper is configured with the modules and wavelengths appropriate to your purchase order.

Figure 7 shows the rear panel of a Viper 442 with the intercom module installed: 4 video channels, 4 dual audio channels and optional intercom, high speed data and contact closures.

The front and rear panels for TX and RX units are identical, except for the name of Transmitter or Receiver, and the use of male connectors on the receivers and female connectors on the transmitters. Refer to Figures 8 through 11 when making connections to the portable units, and to Figures 12 through 16 when making connections to the rack mount units.

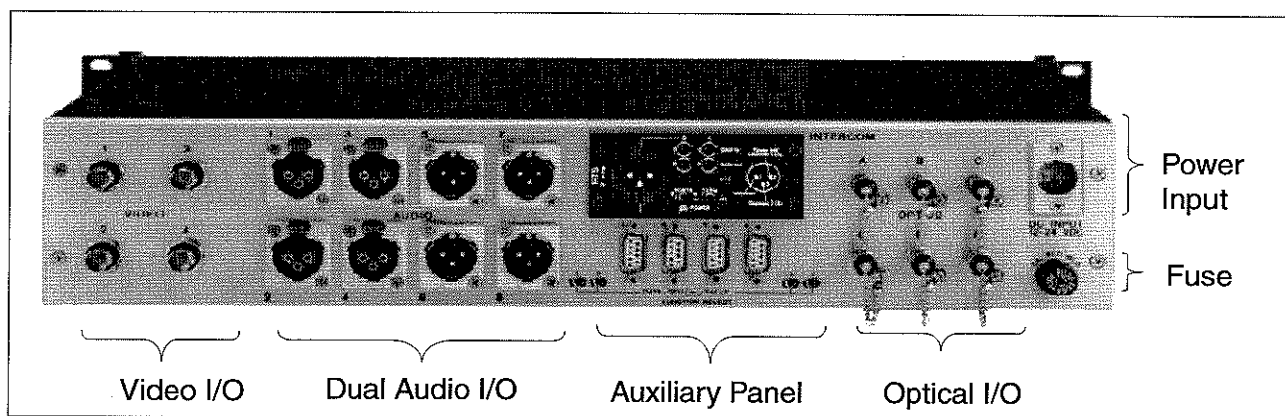

Figure 7. Viper 442 Rear Panel

Status Indicators

LEDs on the rack mount chassis are located on the front panel of all units.

LEDs on the mussel shell chassis are located on the faceplates of the internal battery pack and function modules.

Connector Numbering Conventions

The numbering convention used for the connectors on the portable units is not the same as numbering for connectors on the rack mount units. Portable mussel shell connectors are named in relation to the module slot numbers on the internal main circuit board; the VIM4 has 4 slots of two video and two audio, and the VIM8 has 8 module slots.

The video cards installed in slots 1 through 4 connect to the BNC connectors numbered **S1-S4**. Dual audio cards installed in slots 5 through 8 connect to XLR connectors numbered **S5-1** to **S8-S2**.

Rack mount video and audio connectors are numbered starting from one. The 442 has 8 module slots, with video connections numbered from 1 through 4 and audio connections numbered from 1 through 8.

Optical connections for the rack mount units are numbered alphanumerically. Portable chassis optical connectors are mounted onto the main circuit board.

Chassis Configuration

VIM4

The VIM4 is the small mussel shell, a 4-slot portable chassis which supports up to 4 fibers: 2 video cards, 2 dual audio cards and 1 auxiliary option.

The VIM4 front panel shown in Figure 8 supports the following:

- Power switch
- 2 Amp SLO BLO fuse
- DC input power
- **AUX 1**, which connects to an auxiliary board attached to the audio modules in slots 3 and 4. The **AUX 2** connector is inoperative on the VIM4, which has the capacity for only one optional interface.
- Military 4-fiber connector (Figure 8) or Kellems™ grip (Figure 10).

The most common configuration of the VIM4 specifies fibers 1 and 2 for audio and fibers 3 and 4 for video. Fiber 2 also carries the optional auxiliary signal.

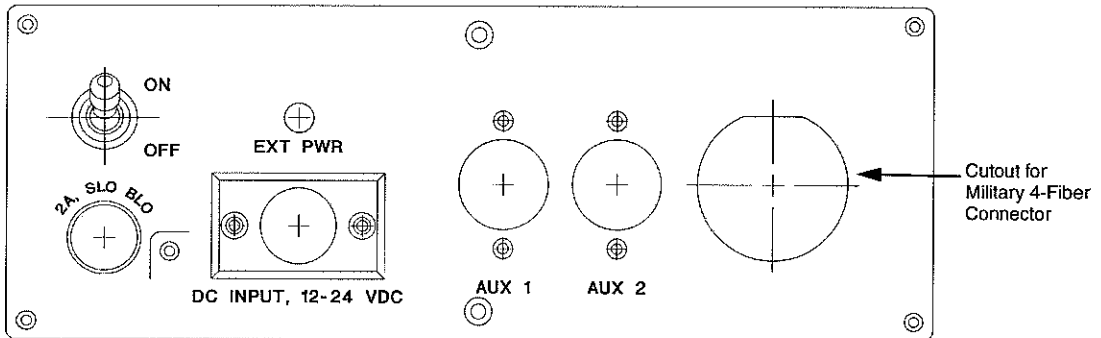

Figure 8. VIM4 Front Panel

The VIM4 rear panel is the same, regardless of the type of fiber interface used. The rear panel shown in Figure 9 supports the following:

- 2 BNC connectors, one for each video card installed in slots 1 and 2. Connect the video module in slot 1 to **S1-1**, and the video module in slot 2 to **S2-1**.
- 4 XRL connectors, two for each dual audio card installed in slots 3 and 4. Connect the dual audio module in slot 3 to **S3-1** and **S3-2**, and the module in slot 4 to **S4-1** and **S4-2**.

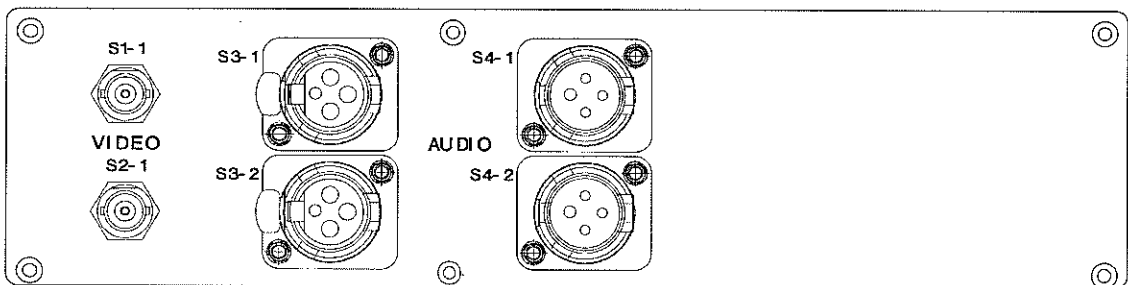

Figure 9. VIM4 Rear Panel

VIM8

The VIM8 is the large mussel shell, an 8-slot portable chassis which supports up to 6 fibers: 4 video cards, 4 dual audio cards and 2 auxiliary options. Power connects to the front panel **DC INPUT** connection; the input power fuse connection is to the left of the DC Input.

The VIM8 front panel shown in Figure 10 supports the following:

- **AUX 1**, which connects to an auxiliary submodule circuit board attached to the audio module in slots 5 through 8; refer to *Auxiliary Submodule Boards* on page 33.
- **AUX 2**, which connects to an auxiliary submodule circuit board attached to the audio module in slots 5 through 8.
- Kellems grip opening (Figure 10) or military fiber connector with 4 fibers (Figure 8).

The most common VIM8 configuration specifies fibers 1 and 2 to carry audio and auxiliary signals, and fibers 3 through 6 to carry video.

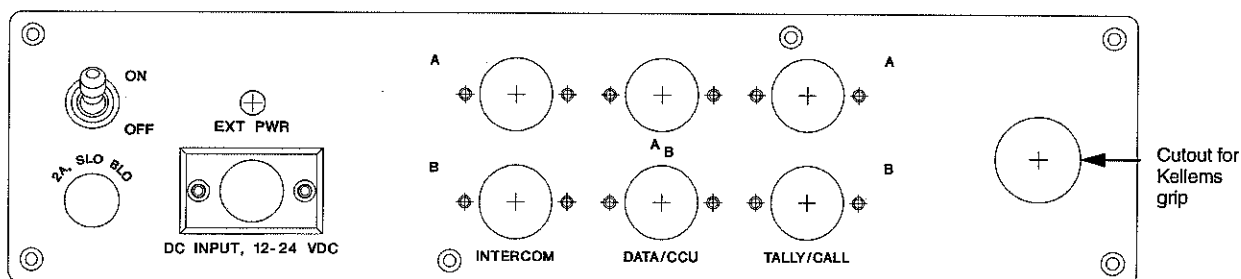

Figure 10. VIM8 Front Panel

The VIM8 rear panel shown in Figure 11 supports the following:

- 4 BNC video connectors, one for each video module installed in slots 1 to 4.
Connect the video module in slot 1 to **S1-1**, the video module in slot 2 connects to **S2-1**, the video module in slot 3 to **S3-1** and the video module in slot 4 to **S4-1**.
- 8 XLR connectors, two for each dual audio module installed in slots 5 to 8.
Connect the dual audio module in slot 5 to XLR connectors **S5-1** and **S5-2**, the module in slot 6 to XLR connectors **S6-1** and **S6-2**, the module in slot seven to XLR connectors **S7-1** and **S7-2** and the module in slot 8 to XLR connectors **S8-1** and **S8-2**.

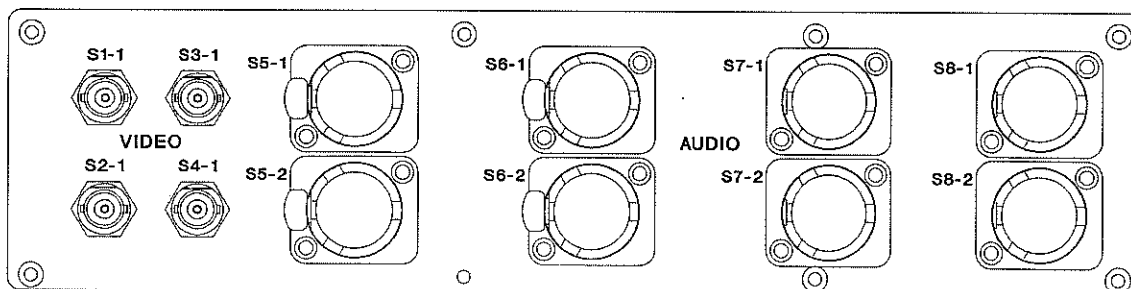

Figure 11. VIM8 Rear Panel

442

The 442 is an 8-slot rack mounted chassis which supports up to 6 fibers: 4 video cards, 4 dual audio cards and 2 auxiliary options. Power connects to the rear panel DC input connection, above the fuse holder. The rack mount 442 and the portable VIM8 have the same internal configuration and main circuit board installed and have equal capabilities.

The 442 front panel shown in Figure 12 supports the following:

- **POWER** switch, which is the only external switch on the chassis.
- **EXTERNAL POWER** LED, which is electrically in parallel with the **EXT PWR** LED on the internal battery pack.
- **INTERNAL RESERVE** LED, which is electrically in parallel with the **INT BATT** LED on the internal battery pack.
- **VIDEO 1** to **VIDEO 4** LEDs, which are electrically in parallel with the respective LED on the faceplate of installed function modules.
- **AUDIO RX STATUS** LED, which is electrically in parallel with the video receiver.

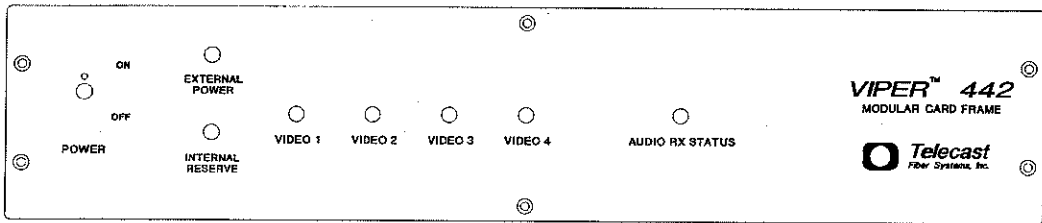

Figure 12. 442 Front Panel

The Viper 442 rear panel shown in Figure 13 supports the following:

- 4 BNC video connectors, 1 for each video module installed.
The video module installed in slot one connects to the video BNC connector labelled **1**, the video module in slot 2 connects to the connector labelled **2**, until all fibers are connected.
- 8 XLR dual audio connectors, two for each dual audio module installed.
Connect the dual audio module in slot 5 to the audio XLR connectors labelled **1** and **2**, the module in slot 6 connects to the XLR connectors labelled **3** and **4**, the module in slot 7 connects to XLR connectors labelled **5** and **6**, and the module in slot 8 to XLR connectors labelled **7** and **8**.
- Auxiliary submodule panel.
- 6 ST type optical connections, labelled **A** through **F**.

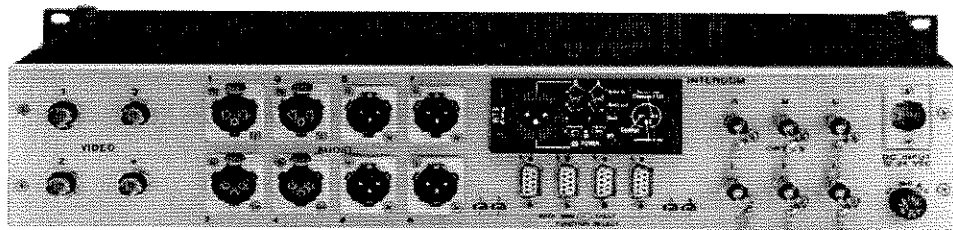

Figure 13. 442 Rear Panel

V800D

The V800D is an 8-slot chassis which transmits and receives analog and/or digital video. It supports 8 fibers and 8 video cards. Standard operation has one V800D transmitting and a second V800D receiving. Power connects to the rear panel DC input connection, above the fuse holder.

The V800D front panel shown in Figure 14 supports the following:

- **POWER** switch, which is the only external switch on the chassis.
- **EXTERNAL POWER** LED, which is electrically in parallel with the **EXT PWR** LED on the internal battery pack.
- **INTERNAL RESERVE** LED, which is electrically in parallel with the **INT BATT** LED on the internal battery pack.
- **VIDEO SYNC** LEDs 1 through 8, which are electrically in parallel with LEDs on the faceplate of installed function modules.

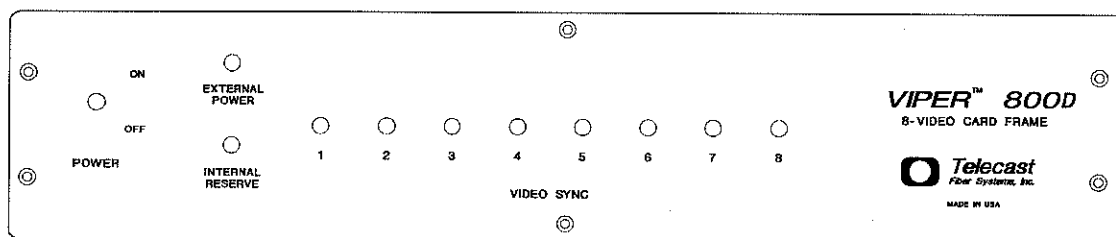

Figure 14. V800D Front Panel

The V800D rear panel shown in Figure 15 supports the following:

- 8 BNC video connectors, one for each video module installed in slots 1 to 8. Connect the module in slot 1 to the BNC connector labelled **1**, the module in slot 2 to the BNC connector labelled **2**, until all modules are connected.
- 8 ST type optical connectors, one for each video module installed in slots 1 to 8. Connect the module in slot 1 to the ST connector labelled **A**, the module in slot 2 to the ST connector labelled **B**, the module in slot 3 to the ST connector labelled **C**, until all modules are connected.

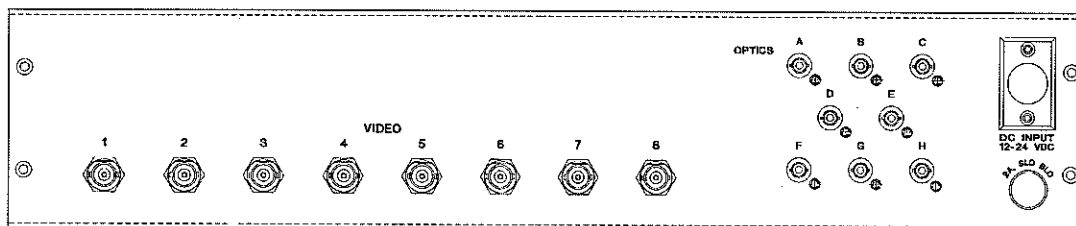

Figure 15. V800D Rear Panel

Summary

Note: All Viper units can transmit and receive video.

- When you need to transmit and receive up to 2 connections each of audio and video, use the portable VIM4.
- When you need up to 4 video connections and up to 8 dual audio connections, use either the portable VIM8 or the 442.
- When you do not need audio, but need to transmit and receive up to 8 connections of analog or digital video, use the V800D.
- When you need audio *and* up to 8 analog or digital video connections, use the V800D and a Telecast Adder.

Signal Connections

Audio

Audio I/O interface is via XLR connectors. Audio input levels are set up for each channel by switches on the I/O module faceplates. The switches set input gains of 0 or 50 dB, and input resistance of 600 Ω or 5 k Ω , also set from the module front panel.

Audio modules in the portable chassis connect to the XLR connectors labelled with the same slot number as the module, as well as to the XLR connector directly below it for dual audio capabilities. For example, the first audio module installed in a VIM8 occupies slot 5 and connects to the XLR connectors labelled **S5-1** and **S5-2**. Refer to the individual drawings for each model for the associated wiring conventions.

The industry standard wiring of this connector is shown in Table 7.

Table 7. Audio XLR Pinout

Pin	Signal
1	Ground
2	- Balanced I/O
3	+ Balanced I/O

A representative panel showing the model 442 with the TX and RX XLR connectors called out is shown in Figure 16.

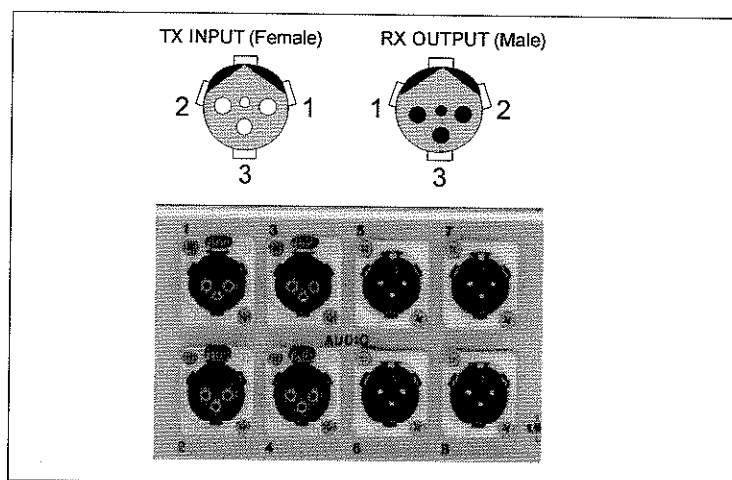

Figure 16. XLR Connectors on a 442 Rear Panel

Note: The 48 VDC phantom supply for microphone biasing is not available on any Viper model. Switches for gain and ground are set on the faceplates of the I/O modules. Refer to the I/O module discussions beginning on page 20 for specific information on setting up or adjusting audio signals. The Viper uses high frequency pre-emphasis on all audio channels. Maximum level at 1 kHz with all gain switches off (unity gain) is +18 dBm. Maximum level at 20 kHz is 10 dB lower, or +8 dBm.

Video

The video connector used for the VIM4, VIM8, 442 and the V800D is a BNC type connector with a 75 Ω video input signal.

A video module connects with the BNC port labelled with the same number as the slot in which the module is installed. For example, the first TX 259 video module installed in a VIM8 occupies slot 1 and connects to BNC port **S1-1**.

Viper model V800D have 8 LEDs on the chassis front panel that display the video connection status.

Optical Fiber

The standard connector on rack mount units is the ST type connector. The VIM4 and VIM8 portable units are supplied with either ST type connectors or with a quick-connect military connector, which connect into 4-fiber Tac-4 cable (or similar) to carry optical signals in any direction.

When connecting optical fiber to ST connectors on portable units, use a Kellems™ grip with the Tac-4 fiber to relieve fiber strain while providing a very secure connection to the ST connectors mounted on the main circuit board. The Kellems grip with Tac-4 fiber is shown in Figure 17.

Transmission Fiber Ports

The optical fiber ports transmit digitized, multiplexed video. Unless the WDM is used, each I/O module sends or receives over its own fiber port. Audio, digital data, camera control and intercom signals are transmitted on separate fibers; there is no redundancy in the Viper system. Each output has the same capacity. Distance capabilities depend on fiber choice and wavelength, as indicated in Table 9 on page 19.

The Viper RX chassis fiber ports receive multiplexed optical signals from the output of a Viper TX chassis. The signal is then demuxed and transmitted to the receiver output corresponding to the original input on the transmitting assembly.

The Viper operates with low-loss fiber optic cable. Pre-installed fiber cable (backbone) and tactical mobile field fiber optic cable are available from Telecast; consult the factory. Telecast also supplies military grade, tactical fiber.

Note: With pre-installed fiber cable, use patch cords to plug the chassis into the cable system.

The fiber is wound onto a wooden reel or on Telecast's Portable *Ox-Frame* reel (see Figure 18 on page 18) depending on cable type and size.

The Viper may be used with installed backbone cables or with other dedicated cables. Cable ends split out as a multifiber *harness* at each end and terminate with either industry standard ST type connectors or 4-pin military connectors. Consult Telecast regarding compatible fiber types.

WARNING Never look directly into the end of the optical fiber while either end of the system is operating. Eye damage can result.

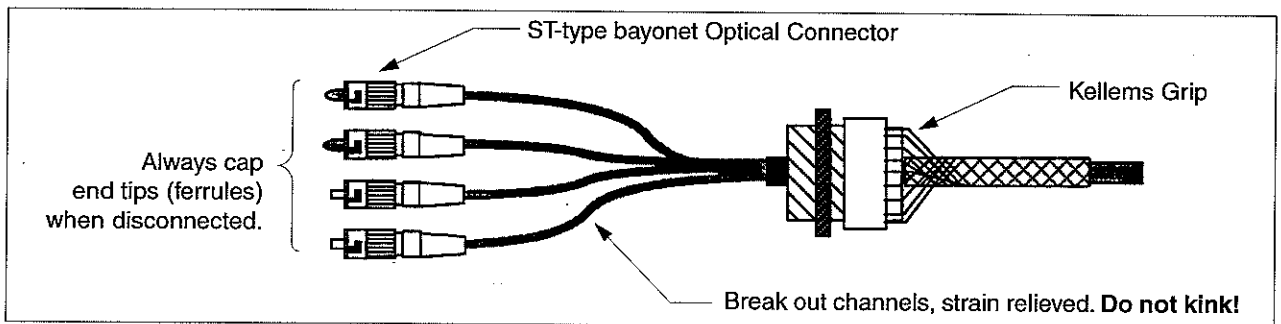

Figure 17. Tac-4 Cable and Kellems Grip Interconnect

Military Connectors

The military connector is a durable, quick release 4-fiber connector providing superior field durability and offering easier connections. This connector has a plug on the reel end and a receptacle on the chassis end. It is made of hard-coated, anodized aluminum and features Neoprene O-rings and hermaphroditic connectors (containing both male pins and female sockets), which allow the fibers to maintain their orientation along a multiple cable run. See Figure 18.

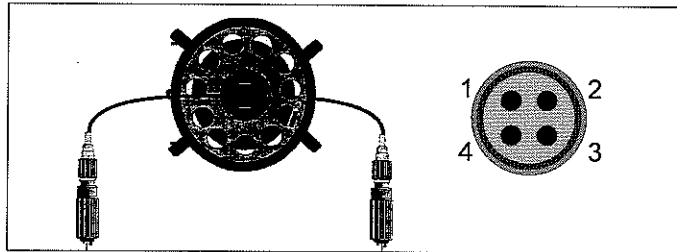

Figure 18. Military Connectors and Ox-Frame Reel

Pin assignments are configured to customer requirements at the time of purchase. In the absence of specific pinouts for your purchase, Telecast has wired the connector as shown in Table 8.

Military connectors are mated by aligning pins 1 and 2 of the first connector to pins 3 and 4 of the second connector.

Table 8. Military Connections

Reel End		Chassis End	
Pin	Signal	Pin	Signal
1	Video Out	1	Video Out
2	Audio Out	2	Audio Out
3	Audio In	3	Audio In
4	Video In	4	Video In

Fiber Cable Runs

I/O connections must be multimode (mm) and single mode (sm) compatible, with fiber distances limited by fiber losses; distance capabilities depend on fiber choice and wavelength. Fiber types must be compatible with the desired transmission range; see Table 9.

Note: When using a WDM in the TX, the transmitting fiber and the receiving WDM must match that of the transmitting WDM to assure performance to specifications.

For custom cable fabrication, use type ST connectors such as Telecast part number CONN-ST. Always follow the connector manufacturer's directions when fastening a connector to the cable. A Quick-crimp kit, part number CKIT-ST, is available from Telecast.

Connect the fibers to the Viper chassis at each port, and cap any unused fibers.

Table 9. Distance Limits by Fiber Type

Fiber Type	Maximum Distance	Wavelength	I/O Mode
N-Level	1 km	850 nm	multimode
P-Level	2 km	850 nm	multimode
L-Level	5 km	1300 nm	multimode
W-Level*	5 km	1500 nm	multimode
S-Level	20 km	1300 nm	single mode
SW-Level	20 km	1500 nm	single mode
* For use with WDM applications.			

Connecting a Fiber

1. Inspect and clean the fiber ends with clean, dry compressed air or with Kim-Wipes that have been wet with isopropyl alcohol. Fingerprints or other dirt on the optical connector end surfaces will reduce the received optical signal level.

This is especially important in single mode applications.

2. Plug the cable into the rack mounted or portable chassis directly to an ST or military connector on the rear panel, or by using intermediate patch cords.
3. Cap each unused fiber connector end and receptacle.
4. Inspect the cable harness or patch cord ends for any breakage due to kinking.
5. Thread the patch cords or multifiber harness through the portable chassis opening, ensuring that the individual fibers are not kinked.
6. Deploy the fiber cable by either carrying the reel to the remote location while dropping cable behind or by pulling the cable from a fixed-location reel.

Note: If military connections are not used, leave the free end of the portable chassis attached to the cable to protect the fiber ends.

Note: To keep the cable from twisting during reel rotation, disconnect the reel end of the portable chassis during installation; carefully wind up the short end of the cable for storage inside the reel's center hub.

Function Modules

Audio and video are transmitted via I/O function modules which plug into the Viper chassis. Function modules are available in sets, with the TX module transmitting to a respective RX module in a second Viper unit. An exception is the TR 260 Transceiver module, which has the TX and RX I/O connections together on one module. Viper systems can be field reconfigured for different signals by rearranging the I/O modules and installed options, and by installing alternate modules appropriate to your chassis. The resulting optical signal from a TX port must feed into an RX port of matching wavelength. Refer to *Viper Field Reconfiguration* on page 40 for more information on user reconfiguration.

Options include:

- Input audio and video modules in a Viper transmitter (TX)
- Output audio and video modules in a Viper receiver (RX)
- Auxiliary option
- WDM (Wavelength Division Multiplexer) to reduce the number of required fibers in half.

The **auxiliary option** provides two channels each of the following signal functions:

Intercom 2-wire RTS, Clear-Com or 4-wire balanced audio.

CCU/Data High speed (above 100,000 baud) 4-wire RS-422 data or camera control interface for Sony® RMM-7/RMM-3 hand held remote controls.

Tally/Call Switch closure interface function.

The auxiliary option consists of three components: auxiliary I/O board, auxiliary submodule receiver board and auxiliary submodule transmitter board. Refer to page 33 for more information.

Note: Analog and digital modules are compatible in any slot in any rack.

Table 10. I/O Function Modules

Function Module	Transmission Type
TX/RX 103	Analog video module set
TX/RX 259	Digital video module set
TX/RX 292	High Definition 1.5Gb/s digital video module set
TX/RX 280	Dual channel 18-bit audio module set with auxiliary connection
TX/RX 380	Dual audio expansion module set
TR 260	AES/EBU Digital audio transceiver module

TX/RX 103: Analog Video

The Viper system transmits analog video via the TX/RX 103 analog video module set, which converts electrical video input signals into an optical format for transmission from the base location to a remote site over an optical fiber. Video input and output block diagrams are shown in Figures 19 and 21.

The electrical video signal inputs through a BNC connector located on the side of the portable chassis and on the back of rack mounted systems. The transmission level is 1.0 V nominal peak to peak, terminating at 75 Ω. The optical fiber is coupled to an ST optical connector.

TX 103 Video Transmitter

The TX 103 Video Transmitter module transmits an optical signal at 30 MHz. An ultralinear frequency modulation scheme minimizes intermodulation distortion. TX 103 models are available to transmit signals at wavelengths of 850 nm, (short wavelength), 1300 nm (multi or single mode) and 1550 nm (multi or single mode).

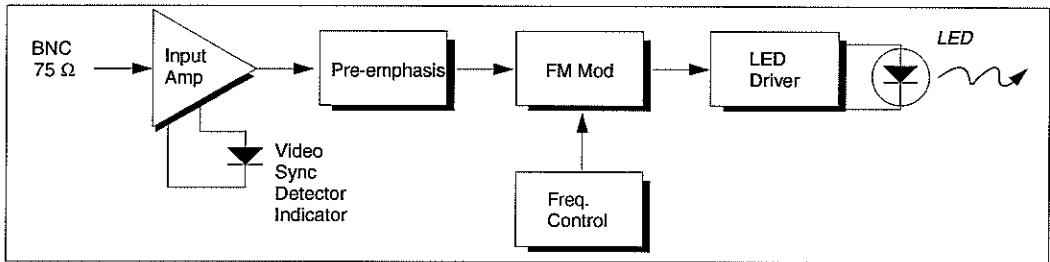

Figure 19. Analog Video Input Schematic

The **Sync** LED on the left side of the TX 103 module faceplate shown in Figure 20 illuminates green when video sync is present. There is no illumination when sync is not detected.

Information on the upper right side of the faceplate lists the wavelength the module has been configured for and the fiber type to be used, either single mode or multimode.



Figure 20. TX 103 Video Module

RX 103 Video Receiver

RX 103 video receiver module accepts the optical input signal from the transmitter and converts it to an electrical video signal. Operation is based on a positive intrinsic negative (p-i-n) detector. Video output is via BNC connectors on the appropriate front panel.

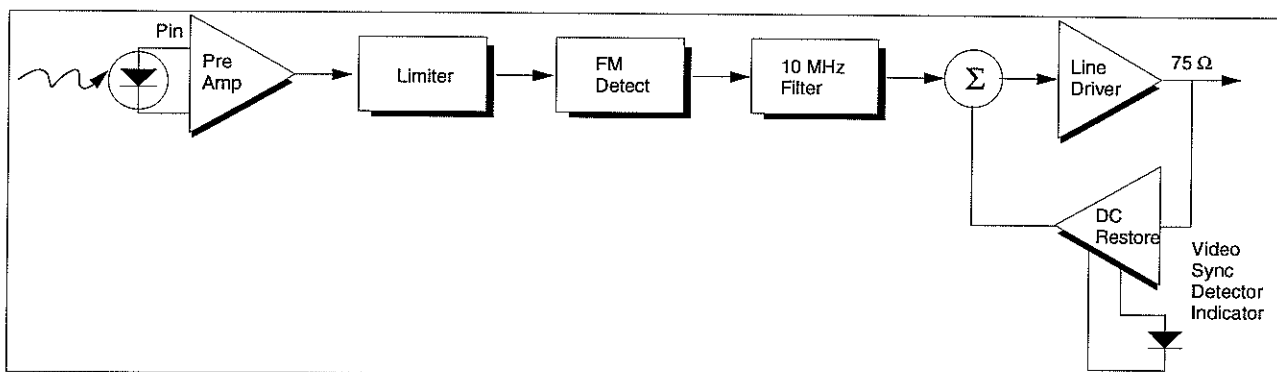

Figure 21. Analog Video Output Block Diagram

The **Sync** LED on the left side of the RX 103 faceplate shown in Figure 22 illuminates green when video sync is detected, red when an optical signal is present but sync is not present, and orange when neither an optical signal nor sync is present.

The **Level Adjust** potentiometer changes the video output voltage ± 3 dB from unity gain.

The configured wavelength is listed on the right side of the faceplate.



Figure 22. RX 103 Video Module

Return Video

Black burst, or return video, is the video image transmitted from the remote location back to the camera viewfinder or auxiliary monitor at the base location. Return video is accomplished on the Viper by connecting a second set of TX/RX 103 video modules in the opposite direction for black burst transmission.

Viewfinder displays in the video camera operate in two ways:

- The viewfinder image is developed and displayed within the camera but does not get transmitted to the base station.
- The viewfinder image is sent to the base station for development, and then transmitted back to the camera viewfinder.

Return video is used for teleprompting functions, or for program video transmission if the installation direction is reversed.

TX/RX 259: Digital Video

The TX/RX 259 video module detects the presence of serial digital video, equalizes the signal for type 8281 coaxial fiber lengths (320 meters minimum), and transmits the signal over fiber where the Viper RX reconverts the signal to an electrical CCIR 601 signal. Transmissions are sent at wavelengths of either 1300 nm or 1550 nm.

Up to four TX/RX 259 modules can plug into the Viper portable chassis and 442 rack mount chassis. Up to eight can plug into the V800D.

The TX/RX 259 serial digital video module block diagram is shown in Figure 23.

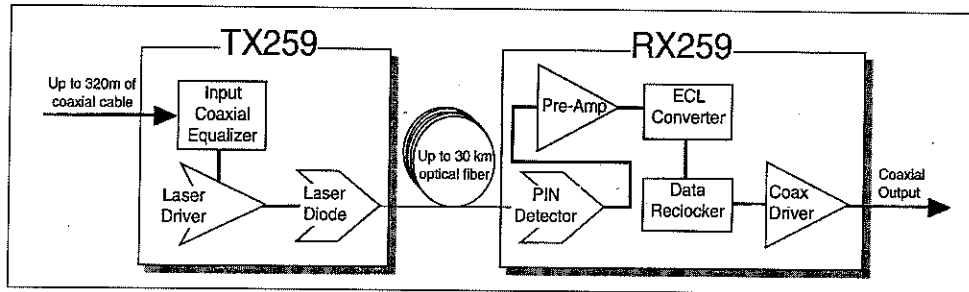

Figure 23. TX/RX 259 Digital Video Module Set Block Diagram

Installing the TX/RX259

Installing digital video cards in the Vipers (this applies to the 292's also) requires that the coaxial SMA connector be dis-connected from the main PC board and attached directly to the TX and RX card. Each video slot uses these same SMA connectors but they remain attached to the main PC board when analog 103 cards are used. Carefully unscrew the SMA connector from the main PC board and then screw it into the SMA receptacle on the 259 card. Do not overtighten. Then, plug the module into the corresponding slot and secure it to the chassis via the two screws. See Figure 24.

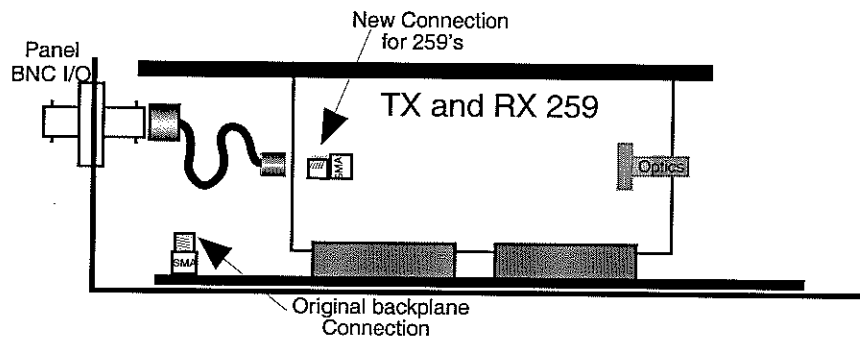

Figure 24. TX/RX 259 Connections

TX 259 Transmitter

Figure 25 illustrates the TX 259 video module faceplate. The **Input** LED on the left side of the module faceplate illuminates green when video is detected. There are no other controls at the BNC input.



Figure 25. TX 259 Digital Video Transmitter Module

RX 259 Receiver

The **Lock** LED on the left side of the RX 259 module faceplate, shown in Figure 26, illuminates green when the optical detector system has locked on a received optical signal.



Figure 26. RX 259 Digital Video Receiver Module

TX/RX 292: Up to 1.5Gb/s High Def Video

The TX/RX 292 detects the presence of serial digital video at transmission rates from 19.4 Mbps to 1.5 Gbps. The cards are completely format transparent and support numerous interfaces including SMPTE, ATSC, Bellcore and DVB standards. Up to 320 meters of 8281 coaxial cable at rates up to 540 Mbps can be equalized by the TX card using the “EQ” input. Up to 20 feet of 8281 at the higher transmission rates can be used via the “Direct” input. The TX/RX 292 serial digital block diagram is shown in figure 27.

The serial digital signal is transmitted over fiber at wavelengths of either 1300 nm or 1550 nm and is solely a single-mode device. Up to four TX/RX 292 modules can plug into the portable Viper mussels and 442 racks. Up to eight TX/RX 292’s can be used in the V800-D. Installation is the same as with the TX/RX259’s, requiring that the SMA coaxial connector be dis-connected from the main PC board and attached to the 292 module.

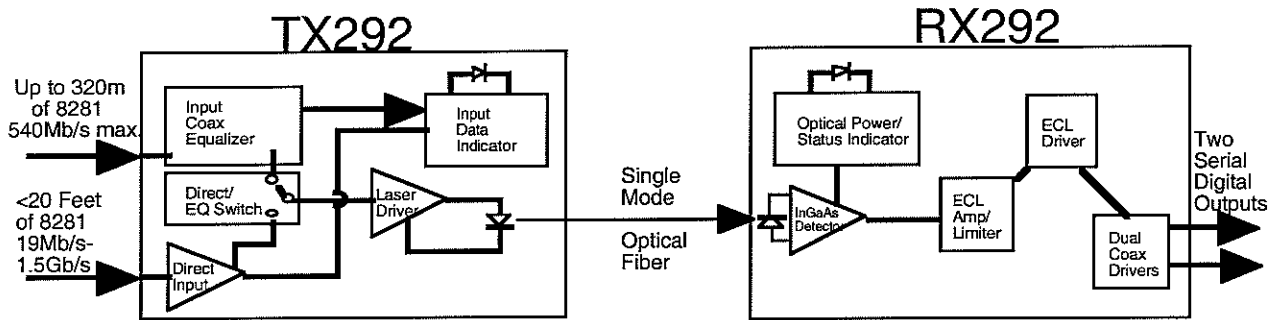

Figure 27. TX/RX 292 Serial Digital Module Sets Block Diagram

The following formats can be implemented with the TX/RX 292 module set:

- | | |
|---------------------------|----------------------------------|
| 19.4 Mb/s ATSC | 34 Mb/s E3 |
| 34 Mb/s DS3 | 143 Mb/s NTSC Composite |
| 177 Mb/s PAL Composite | 270 Mb/s Serial Component |
| 360 Mb/s Serial Component | 360 Mb/s Compressed HDTV |
| 540 Mb/s Proprietary | 1.2 & 1.5 Gb/s HDTV Uncompressed |

Installing the TX/RX292

Installing TX/RX292 cards requires that the coaxial SMA connector be dis-connected from the main PC board and attached directly to the TX and RX card. Each video slot uses these same SMA connectors but they remain attached to the main PC board when analog 103 cards are used. Carefully unscrew the SMA connector from the main PC board and then screw it into the proper SMA receptacle on the 292 card. Do not over-tighten. Then, plug the module into the corresponding slot and secure it to the chassis via the two screws. See Figure 28.

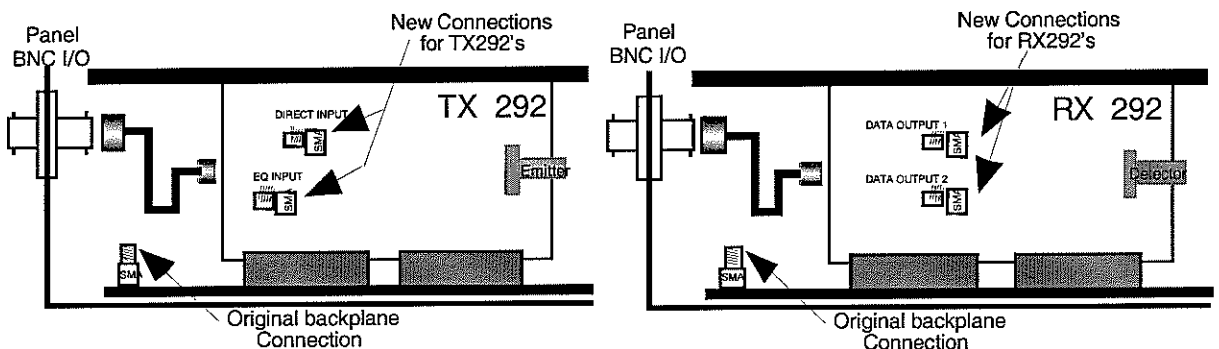

Figure 28. TX 292 and RX 292 Connections

TX 292 Transmitter

Figure 29 illustrates the TX 292 video module faceplate. The **Data** LED on the left side of the module faceplate illuminates green when data is detected. The **Input** switch allows the user to select between a **Direct** input for less than twenty feet of 8281 at transmission rates from 19 Mb/s to 1.5 Gb/s and an **Equalized** input for up to 320 meters of 8281 at transmission rates of 540 Mb/sec or less. The SMA connectors are also labelled **Direct** and **EQ**. When installing the TX 292 it is important that the switch be in the same position as SMA input used.



Figure 29. TX 292 Serial Digital Video Transmitter Module

RX 292 Receiver

Figure 30 illustrates the RX 292 video module faceplate. The **Fiber** LED illuminates green to indicate the presence of optical power. When optical power levels decrease to -23db or less, the LED begins to turn orange. When there is no longer any green color in the LED and it turns to red, the receiver mutes to prevent any bad data or noise from being received. There are two identical SMA outputs, labelled 1 and 2, on the RX 292 PC board as a convenience.



Figure 30. RX 292 Serial Digital Video Receiver Module

TX/RX 280 and TX/RX 380: Digital Audio

Balanced audio signals are transmitted by the TX/RX 280 module set and up to three TX/RX 380 module sets for a maximum of eight audio channels, two channels per module set. Two intercom channels, two high speed data/CCU channels and two relay closures are optional auxiliary functions supported by these modules. Refer to Figure 31.

The 280 module operates as a base module multiplexer and includes fiber connections. The 380 module expands the audio capabilities and functions as a slave to the 280 module. The 380 has the same A/D and D/A converters as the 280, but it uses the 280's timing signal and passes its data through the 280's fiber.

The minimum configuration is one TX/RX module set — this provides two audio channels in a single direction. Each TX/RX 380 module set increases audio capabilities. Reverse audio is provided by an additional 280 or 280/380 module set.

Two TX/RX 280 module sets support two channels of 4-wire or RTS *wet* or *dry* intercoms, two bidirectional data channels and two bidirectional relay closures. Both module sets must send and receive in both directions.

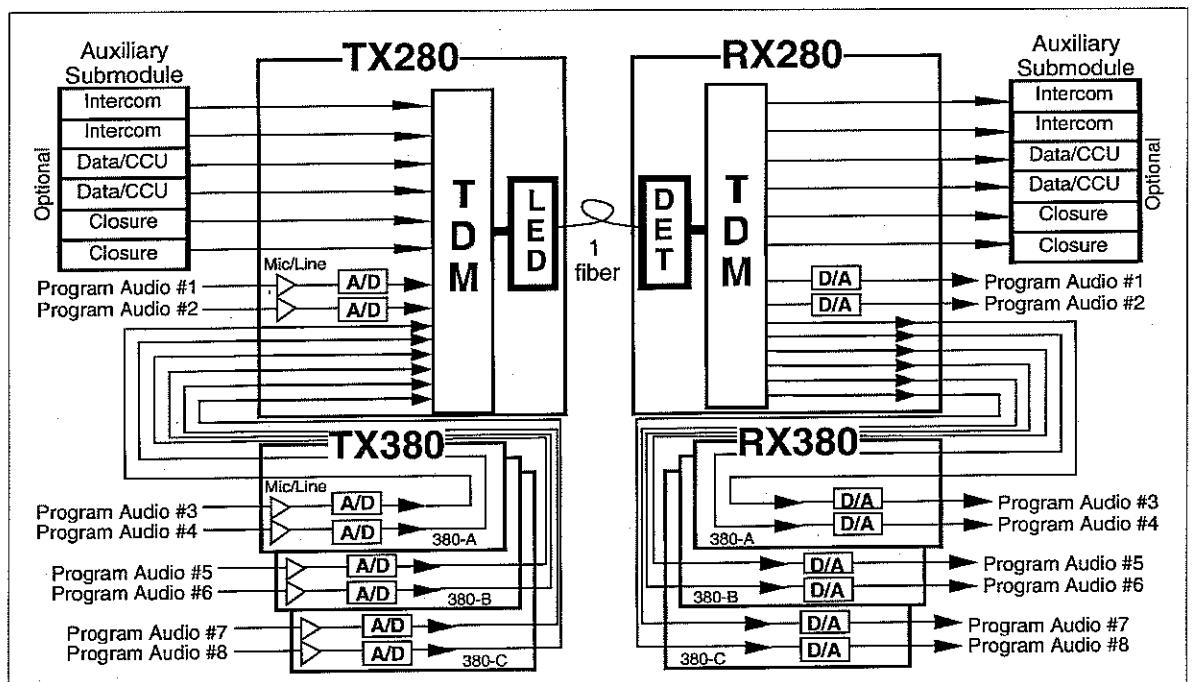

Figure 31. TX/RX 280 and 380 Module Sets Block Diagram

Signal Flow

The 280 module set provides optical circuits for all audio cards. An auxiliary I/O board connects with an auxiliary submodule *daughter board* to provide auxiliary functions (AUX). The daughter board mounts onto the last audio module in the chain — a 280 module if there are no 380 modules, or the 380 module located farthest away from the 280, as shown in Figure 31 and Figure 33. Attachment is via two screws and a ribbon cable. All auxiliary functions multiplex together on the TX 280 module optical output.

A pass-through connector on the 380 module allows up to three 380 modules to be connected.

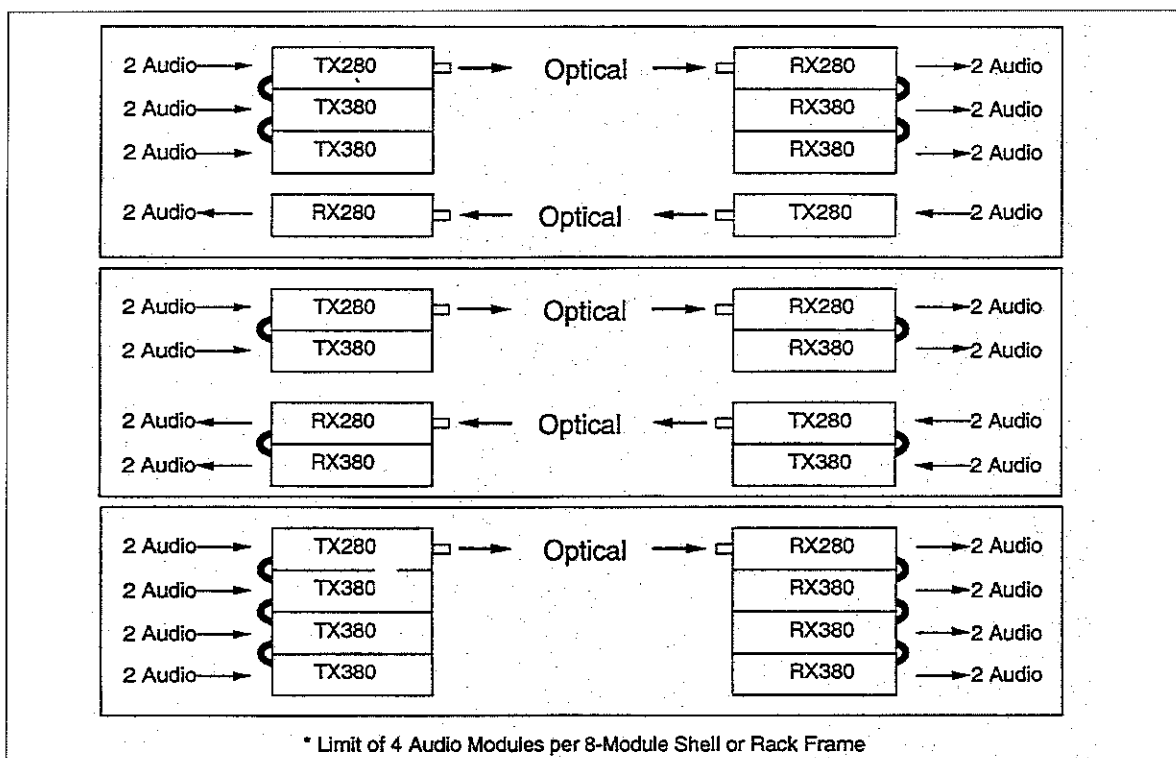

Figure 32. Configuration Options of 280/380 Modules in a 442 or VIM8

Figure 33 illustrates the signal flow of a TX/RX 280 module set with two TX/RX 380 modules attached. Note the auxiliary submodule boards mounted to the last TX/RX 380 module in the link.

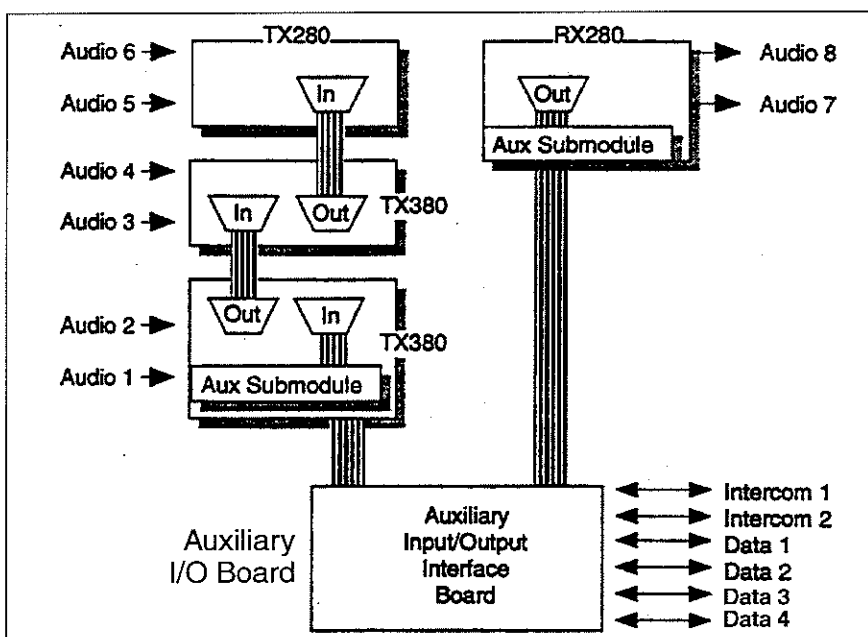

Figure 33. Signal Flow Schematic of 280/380 Modules

Possible configurations are listed in Table 11.

Table 11. 280 Module Configurations

Configuration	Audio Capacity
TX 280 → Fiber	2 Audio
AUX → TX 280 → Fiber	2 Audio + Intercom
AUX → TX 380 → TX 280 → Fiber	4 Audio + Intercom
AUX → TX 380 → TX 380 → TX 280 → Fiber	6 Audio + Intercom
TX 380 → TX 380 → TX 380 → TX 280 → Fiber	8 Audio

The receiving end must be a matched configuration using RX modules. Full duplex intercom operation requires as a minimum a return 280 and AUX set.

Note: Only the first two configurations shown above can be installed into the VIM4 chassis. To install the last two configurations into an 8-slot chassis, the XLR connections must first be modified; refer to *Audio XLR Connectors* on page 41.

TX 280 Transmitter

DIP switches on the TX 280 module faceplate toggle between high or low impedance and 10 db or 50 db of gain for each channel. High impedance input is 5 kΩ (HI), and low impedance is 600 Ω (LO). Termination switches for channel 1 and 2 can be adjusted independently for impedance and gain. See Figures 34 and 35.

Output module gain is variable. Maximum output level at 1 kHz with all gain switches off is +18 dBm; unity gain is 0 db. Maximum level at 20 kHz is 10dB lower, or +8 dBm. Clipping takes place in the A to D converter above a signal level of 18 dBm at 1 kHz.

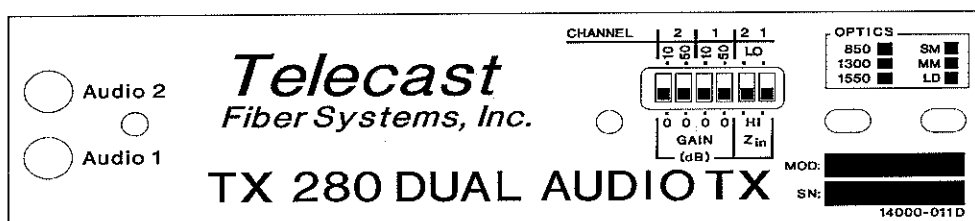

Figure 34. TX 280 Dual Digital Audio Transmitter Module

AUDIO 1 and **AUDIO 2** LEDs illuminate green when the signal is 30 dB below maximum, or when a signal of -12 dBm or greater is present at the respective channel input.

Table 12. TX 280 Input Signal Levels

LOz, 600 Ω balanced		HiZ, 5 kΩ balanced	
Unity gain	+18 dBm peak	Unity gain	+16 dBm peak
+10 dB	+8 dBm peak	+10 dB	+6 dBm peak
+50 dB	-22 dBm peak	+50 dB	-24 dBm peak

Note: High frequency pre-emphasis is used on all audio channels. Maximum level at 20 kHz is 10 dB less than at 1 kHz.

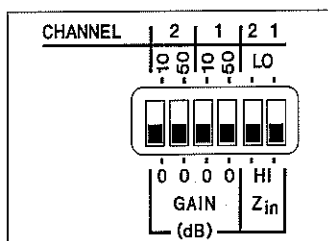

Figure 35. TX 280 Audio Transmission Switch Settings

RX 280 Receiver

The RX 280 receiver module shown in Figure 36 provides a nominal line level output of +18 dBm peak, which can be manually increased or decreased for gain adjustments. Output is to a 30 Ω balanced 3-pin XLR connector on the Viper rear panel.



Figure 36. RX 280 Dual Digital Audio Receiver Module Front Panel

The **STATUS** LED on the left side of the faceplate illuminates red when not receiving a signal from the TX 280. Two **COARSE** level control switches decrease output level for each channel by 10 dB. Two adjustable **FINE** gain control potentiometers allow a ± 3 dB output audio level adjustment for each channel; see Figure 37.

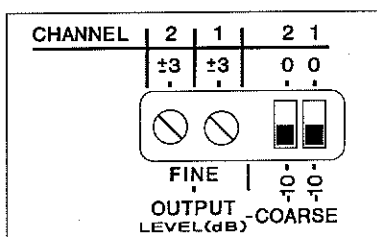

Figure 37. RX 280 Faceplate Controls

TX/RX 380 Audio Expansion Modules

TX/RX 380 modules are two channel audio expansion slave modules which use 18-bit digital encoding to expand the audio capabilities and intercom functions (2 each) in a system configured with TX/RX 280 modules. Each TX/RX 280 module supports up to three TX/RX 380 module sets. Additional fibers are not required.

Frequency response is from DC to 20 kHz ± 0.1 dB, and up to -1.0 dB to 25 kHz. Dynamic range is 95 dB (noise floor to clip). Figure 33 shows a system configured with one TX/RX 280 module set with two TX/RX 380 module sets attached at either end.

Note: All audio RX outputs are actively balanced. DO NOT ground either output pin or severe distortion will result. For use in unbalanced applications, use pins 1 and 3.

TX 380 Transmitter

The TX 380 transmitter module shown in Figure 38 has similar characteristics and controls as the TX 280, except that gain is limited to 40 dB. Since each 280 and 380 module set supports two audio channels, and up to three 380 modules can attach to one 280 module set, the maximum capacity for a single 280/380 combination is eight audio channels, with each channel individually configured for impedance and gain via a DIP switch on the right side of the faceplate. **AUDIO 1** refers to channel 1, and **AUDIO 2** refers to channel 2. A third switch on the module toggles between a high impedance input of 5 k Ω , and a low impedance input of 600 Ω ; see Table 13.

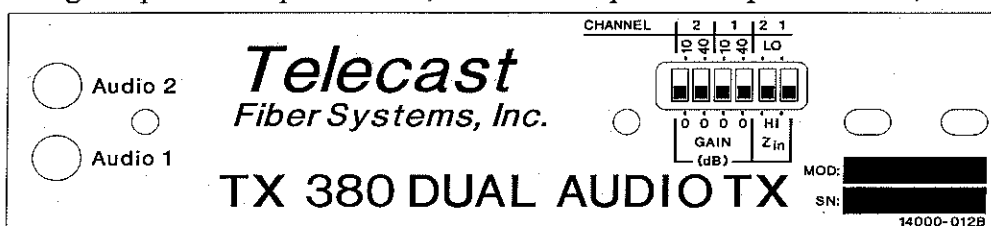

Figure 38. TX 380 Dual Digital Audio Transmitter Module Front Panel

Table 13. TX 380 Input Audio Gain

Gain	Clip Level
0 dB	+ 18 dBm
10 dB	+ 8 dBm
40 dB*	- 32 dBm
*Used for microphone input applications; nullifies the effects of the 10 dB gain selection.	

Note: Select unity gain (0 dB) to avoid clipping at high audio levels or select a lower range to reduce the noise floor and to provide a higher signal to noise ratio.

RX 380 Receiver

The TX 380 receiver module shown in Figure 39 provides a nominal line level output of +4 dBm. This output can be raised or lowered to compensate for changes in the TX 380 gain selection. Receiver output is via a 30 Ω balanced 3-pin XLR connector on the Viper rear panel.

On the right side of the faceplate shown in Figure 39 are two **COARSE** level control switches and two **FINE** level gain control potentiometers which correspond to the audio channels. When set to **COARSE**, the output level decreases by 10 dB. When set to **FINE**, the output audio level adjusts ± 3 dB for each channel.

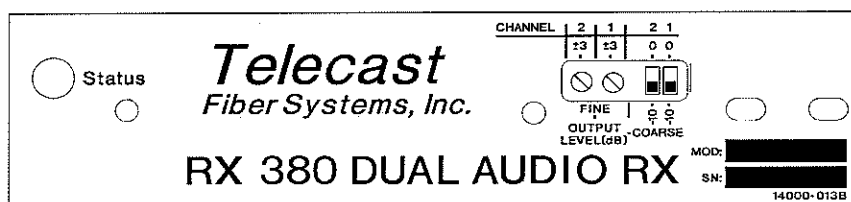

Figure 39. RX 380 Dual Digital Audio Receiver Module Front Panel

TX/RX 380 Address Switches

A DIP switch mounted on the auxiliary submodule daughter board configures each TX/RX 380 module set to a different numerical address to ensure that the transmitted signals output to the correct receiving module.

Set the address switch for the first TX/RX 380 module set to **D0**, the switch for the second module set to **D1** and the switch for the third module set to **D2**. DIP switches shown in Figure 40 are set for D0, the first TX/RX 380 module set.

Note: For each auxiliary submodule board, only one address switch can be set *on*.

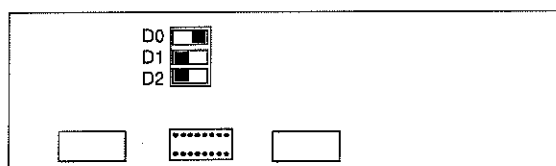

Figure 40. TX/RX 380 Address Switches

TR 260 Transceiver

The TR 260 transmits and receives digital AES/EBU audio data. This module is used in place of analog audio modules, and is compatible with any audio slot in the Viper chassis. **TX** and **RX** LEDs on the left side of the faceplate indicate module operation. The output of this module should be a male XLR attached to Molex connector #1 near the corresponding slot on the Viper mother board. The output should be a female XLR attached to Molex connector #2, just to the right.



Figure 41. TR 260 Digital Audio Transceiver Front Panel

The Auxiliary Option

The TX/RX 280 and TX/RX 380 modules optionally provide up to two channels each of the following auxiliary signal functions: two channels of 4-wire or RTS wet or dry intercoms, two bidirectional data channels and two bidirectional relay closures. Both module sets are required to send and receive in both directions.

The complete auxiliary option consists of the following components:

- 2 auxiliary I/O boards — one TX and one RX.
- 2 auxiliary submodule receiver boards, which mount to the last audio module.
- 2 auxiliary submodule transmitter boards, which mount to the last audio module.
- 14-pin ribbon cable for the connection between the auxiliary submodule and the audio module.
- Four 30-pin ribbon cables — two RX and two TX for the connection between the auxiliary I/O boards and submodule boards.

Auxiliary Submodule Boards

Auxiliary submodule boards provide analog-digital encoding/decoding and interface the signals to the 280/380 digital bus. The submodule board is programmed to utilize the last multiplexer time slot, and must mount onto the last audio module in the chain — a 280 module if there are no 380 modules, or the 380 module located farthest away from the 280. A 14-pin ribbon cable and two screws interface the auxiliary submodule board with the audio module.

A surface mount 10-position DIP switch adjacent to the 30-pin header on both the submodule transmit and receive boards enables all data and audio channels going to and from the auxiliary I/O board. To transmit a field-originated signal to two locations, split the signal — configure the switches to block signals being sent to another location.

Note: For normal operation, all 10 switches should be configured *on*.

Physical differences differentiate between the submodule transmit and receive boards.

The submodule transmitter board has two switches: an audio gain switch at the bottom of the board and a slide switch at the side of the board, towards the bottom. The gain switch adds 40 dB of gain in the intercom channels, allowing use of a microphone or other line level requirements with the 4-wire intercom boards. For unity gain, configure the switch *towards* the 30-pin header; switched away will add the additional 40 dB of gain.

The submodule receive board has a 2-reed relay located on the top of the board; it is a small black incisor, 0.75 inches long x 0.30 inches wide. The transmitter has no relay as the relay closures are a receiving function.

Mounting the Auxiliary Submodule Board

1. Carefully align and mount the submodule board with the threaded tabs below the faceplate of the 280 module.
2. Connect the 14-pin ribbon cable connector from the submodule board to the audio module.
3. Connect the 30-pin ribbon cable connector from the submodule board to the corresponding header on the auxiliary I/O board.

Audio Module Removal

Caution: To avoid damage to the fiber, protect or disconnect the cable before removing any module from the chassis.

1. Turn power *off*.
2. Disconnect the fiber from the module (280 modules only).
3. Remove the 2 screws holding the faceplate to the mounting bar.
4. Remove the desired module(s).

Audio Module Installation

1. Configure the TX/RX 380 module switches.
2. Align the module's edge connector to those on the main circuit board and push until the module is seated.
3. Secure the module's faceplate to the mounting bar with 2 screws, taking care not to damage the fiber.
4. Reconnect the RX/TX 280 module's fiber.
5. Turn power *on*.
6. Check the module indicators.

Note: When removing a 280/380 module set, the modules must be removed together — the 14-pin ribbon cable connects the modules.

DATA/CCU

Camera control interface and digital data is transmitted via the DB-9 connectors. Connection specifications are defined in . A 110 Ω terminating resistor placed across the balanced inputs may be needed if input cable lengths are in excess of 6 feet. Serial communications can be RS-232 at one end and RS-422 at the other, if desired.

This switch sets this data port to be bidirectional on a single pin or splits the signal in order to have two balanced data lines.

TALLY/CALL

Contact closure is established by an isolated, normally open, dry contact.

New Viper DB-9 Data Configurations

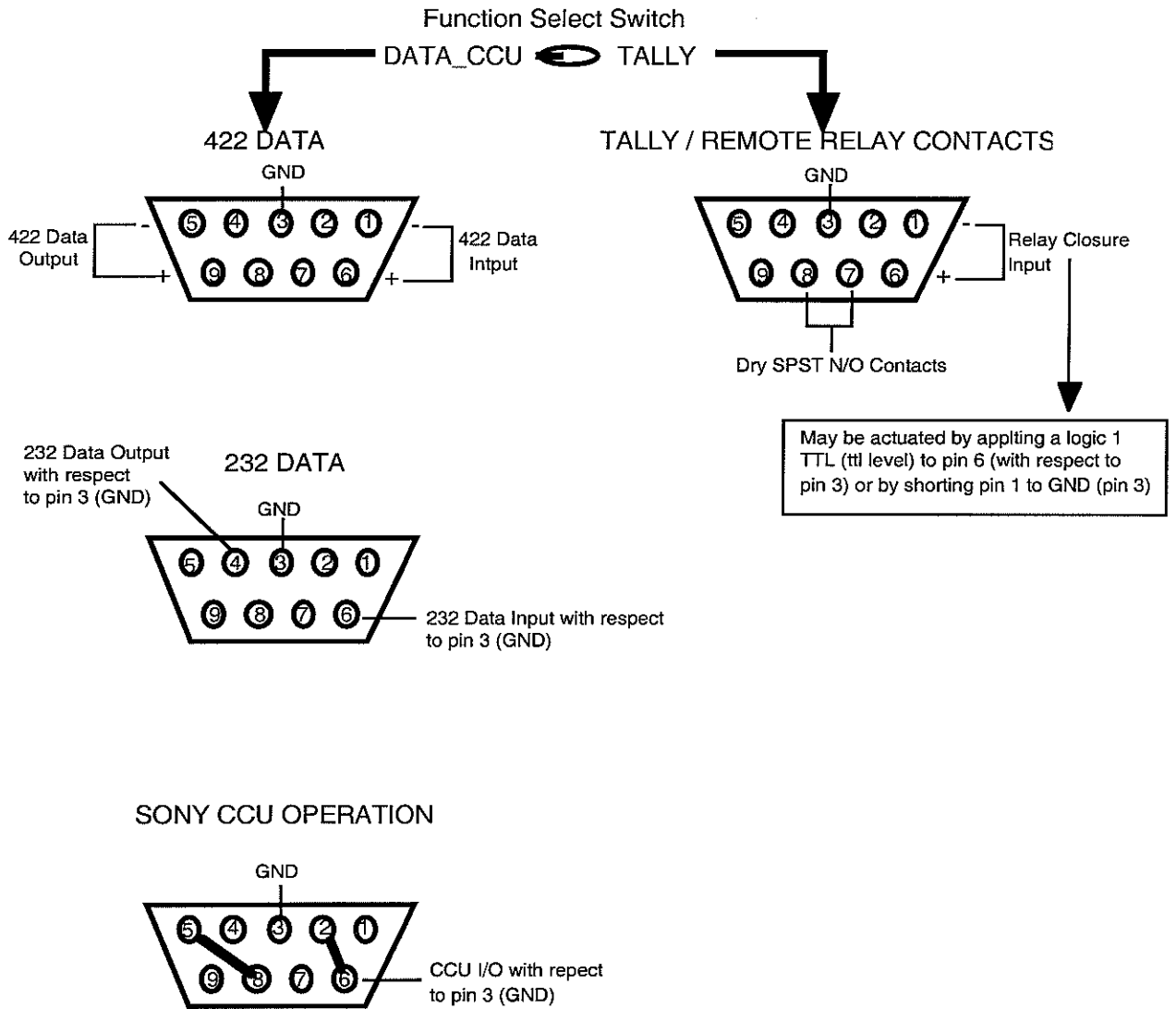

Figure 42. Data Configurations

Intercom Modules

One dual-channel intercom module can be installed into the Viper. Three types of intercom modules are available from Telecast:

- Two balanced 4-wires
- Two Clear-Com 2-wires
- RTS compatible dual-channel 2-wire

The Intercom module is located on the side panel of the Viper mussel and in the rear of the Viper 442 chassis.

Note: A 2-wire system can be interconnected with a 4-wire system or a different type of 2-wire system but not all intercom functions will work (for example, *calling*).

If an optical split is used to connect fiber to additional receiving locations, the intercom signals will be present at the receiver but transmission back to the originating unit will not be possible.

Intercom Connections

4-wire Auxiliary (balanced)

4-wire Auxiliary (balanced) intercoms use an individual 5-pin XLR on each of the two channels in each module. Refer to Figure 43. XLR pin functions are given in Table 14. Intercom Module Gain is 0 dB.

Note: 50 dB of gain may be added to 4-wire module inputs for MIC level applications via a switch on the intercom Aux-piggyback board. See *Intercom Setup Switches* on page 39.

Table 14. 4-Wire Intercom Connections

Pin No.	Function	Impedance	Signals
1	Ground		
2	Input (+)	600 Ω input	LINE : +8 dBm MIC : - 32 dBm
3	Input (-)		
4	Out (+)	$\geq 600 \Omega$ load	+8 dBm
5	Out (-)		

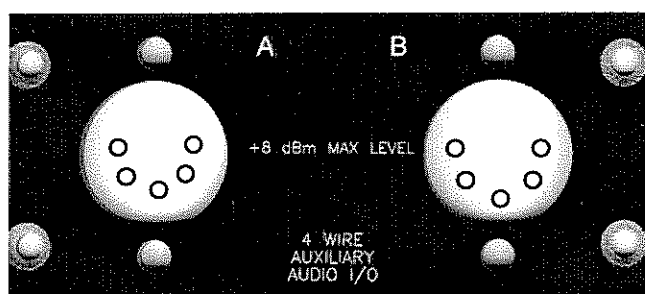

Figure 43. Intercom Panel: 4-Wire Auxiliary (balanced)

Clear-Com

Clear-Com intercom modules have a 3-pin XLR connector for each of the **A** and **B** channels. This Telecast module fully supports the Clear-Com signaling protocol and signal levels. The Clear-Com Intercom Connections are listed in Table 15.

Table 15. Clear-Com Intercom Connections

Pin No.	Function
1	Ground
2	+VDC power
3	Audio

Note: When using a Clear-Com external power supply, pin 3 termination must be lifted on the power supply to prevent motor-boating.

Clear-Com operations are optimized by the use of the front panel adjustments shown in Figure 44 and listed below:

- Input Gain, ± 10 dB
- Output Gain, ± 10 dB
- Null

Switches are also provided for:

- Dry/unpowered (**d**), or Wet/powerd (**w**) **PORTS**
- 200 Ω **on** or **off** terminations **TERM**

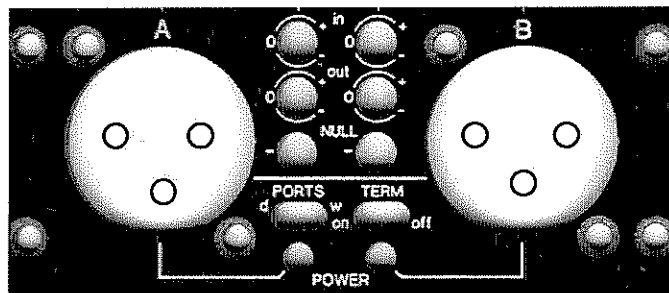

Figure 44. Intercom Panel: Clear-Com

The Telecast Clear-Com interface is compatible with powered and unpowered belt packs as well as fixed equipment. You may power 5 to 10 belt packs with each intercom module from the Viper's internal power supply. Many more belt packs can be added if powered externally. Refer to your intercom manufacturer's documentation for additional system details.

For operation with a belt pack, set the **PORTS** to **w** (wet/powerd), the **TERM** to **ON** and then center each of the **INPUT** gain, **OUTPUT** gain and **NULL** controls. Re-adjust these controls to optimize performance as required.

RTS Telex

RTS modules provide one two-channel intercom on a single 3-pin XLR connector. This Telecast module fully supports the RTS signaling protocol and signal levels.

RTS operations are optimized by the use of front panel adjustments as shown in Figure 45 and listed below.

- Input Gain, ± 10 dB
- Output Gain, ± 10 dB
- Null

Table 16 lists the RTS/Telex pin numbers and intercom connections. Switches are also provided for:

- Dry/unpowered (**d**), or Wet/powerd (**w**) **PORTS**
- 200 Ω **ON** or **OFF** terminations **TERM**

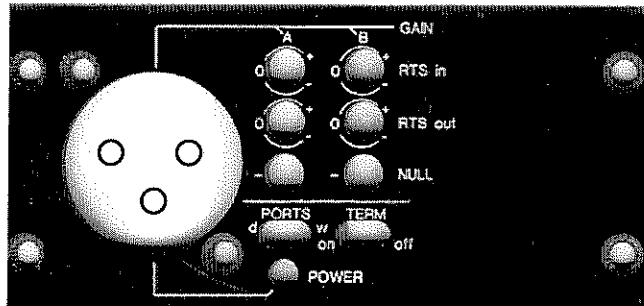

Figure 45. Intercom Panel: RTS Telex

The interface is compatible with powered and unpowered belt packs as well as fixed equipment. You may power 5 to 10 belt packs with each intercom module. Refer to the note on page 36 and to your intercom manufacturer's documentation for additional system details.

For operation with a belt pack, set the **PORTS** to **w** (powered), the **TERM** to **ON** and then center each of the **INPUT** gain, **OUTPUT** gain and **NULL** controls. Re-adjust these controls to optimize performance as required.

Table 16. RTS Telex Intercom Connections

Pin No.	Function
1	Ground
2	+VDC power & Channel 1 Audio
3	Channel 2 Audio

Intercom Module Replacement

Intercom modules within the Viper are installed by Telecast in accordance with your purchase order. Should you want to change or add modules, you may have to reset certain switches on the Aux-piggyback boards in the Viper.

Cable Harnesses

Two multi-conductor cable harnesses connect to the intercom module within the Viper. These cables connect the module to power and signal sources. The first has ten conductors and connects the data sub-assembly board to the intercom module. The second has three conductors and supplies power from the DC-DC converter mounted against the side panel of the Viper. The connectors are Amp-MTA type connectors and they fit all three module types. Use care when inserting and removing these connectors. When using a 4-Wire module, the 3-pin connector is not used since no power is required. Be careful to locate this jumper in a location where it will not cause an electrical short with other components.

Intercom Setup Switches

Switch settings relate to **MIC** or **LINE** input levels for 4-Wire intercoms only. A small switch on the underside of the TX Aux-piggyback board selects between **MIC** or **LINE** input levels. The Aux TX piggyback is attached to the last card in the audio TX module chain whether it is a TX280 or a TX380.

To change an intercom module in the assembly:

1. Turn the power OFF.
2. Remove the four screws that attach the module to the Viper frame.
3. Pull the module half-way out and disconnect the two multi-conductor cables.
4. Remove module.
5. Carefully insert the new module half-way and attach the two multi-conductor cables.
6. Re-install the four mounting screws.
7. Turn the power ON.

Viper Operation

Viper Setup

1. Set the intercom switch on the auxiliary I/O board to the desired type.
2. Deploy the cable from the base location to the remote location, taking care not to damage the fiber.
3. Connect the signal cables: audio XLR connectors, video BNC connectors and optical ST type or military 4-fiber connector.
4. Adjust all audio settings on the audio I/O module faceplates.
5. Connect the external power/battery to the portable chassis (if applicable).
6. Turn the main Power switch on the front panel *on*.

Viper Breakdown

1. Turn power to the remote Viper *off*.
2. Disconnect the external battery from the portable chassis, if applicable.
3. Disconnect all fiber cables.
4. Turn power to the base station chassis *off*.
5. Disconnect all electrical cables.
6. Disconnect the fiber from the reel; cap the connector receptacles and ferrules.
7. Respool the fiber onto the reel.

Note: Evenly spread the cable over the reel's hub to avoid cable spillage or overwrapping when retrieving.

Viper Field Reconfiguration

The Viper system can be reconfigured by the operator to meet different or changed needs, including:

- Changing the system to send or receive video or audio signals in either direction
- Splitting audio signals to be transmitted to multiple destinations
- Adding or changing the intercom/data functions of the units

Transmission wavelength (nm), distance/fiber type and mode (sm or mm) are the variables determining which modules to install during Viper configuration.

Changing the Signal Direction

Note: A familiarity with optical paths is required when attempting to alter the signal direction.

Optical fiber has no directional characteristics, and light may be inserted at either end. Signal directions are changed by removing a set of TX and RX modules and swapping their locations while maintaining slot locations and fiber path. The only physical electrical change is in each module's corresponding signal connector.

Video

Video modules are manufactured in either 850, 1300 or 1500 nm wavelength, with 1300 nm being the most common. The TX 103 video module supports a single video signal being transported on a single fiber. Each module represents a single optical path. If a TX 103 module is switched with its corresponding RX 103 module, the direction of the video signal is reversed.

To change the direction of a single video feed:

1. Remove a TX 103 module from the transmitting end.
2. Remove a RX 103 module from the receiving end and replace with the TX 103 module.
3. Plug the RX 103 module into the original slot of the TX 103 module.
4. Connect each module's ST connector to the original fiber path.

The direction of the video signal is now reversed. To verify the optical path from transmitter to receiver, shine a bright light, a flashlight, sun light or use a transmitter module at one end — and visually sense the light or measure with a power light meter.

In Viper models 442 and VIM8, slots 1 through 4 are reserved for video. In the VIM4 slots 1 and 2 are reserved for video. In the V800A and V800D, all eight slots accept video cards. The only physical electrical change is that the corresponding BNC connector changes between input and output.

Audio

The audio modules operate in the same way as the video modules, and changing the signal direction is done the same way as changing video signals. Optically, this is also true for audio modules RX/TX 280, excluding the audio module’s auxiliary capabilities.

Slots 5 through 8 are reserved for audio in the 442 and the VIM8. Slots 3 and 4 are reserved for audio in the VIM4.

Audio XLR Connectors

The location of the audio transmitter or receiver module is determined by the sex (male or female) of the slot’s audio XLR connector. The module’s function can be changed via an adaptor or a gender connector. Traditionally, the input XLR is gendered female while the output is gendered male. To maintain gender convention, exchange the XLR connectors of the swapped modules or use gender changers to correct the gender.

Note: There is no electrical difference if audio module XLR connectors are not swapped.

To change the direction of a single audio feed:

1. Remove the TX module from the transmitting end.
2. Remove the RX module from the receiving end and replace with the TX module.

To maintain gender, swap the module’s XLR connectors.

3. Plug the RX module into the original slot of the TX module.
4. Reconnect each module to the original fiber path to complete the exchange.

Module Slot Compatibility

Refer to the following tables for the audio and video slot compatibility.

Table 17. 4-Slot Audio/Video Module Standard Configuration

Slot 1	Slot 2	Slot 3	Slot 4
Video TX or RX	Video TX or RX	Audio TX	Audio TX

Table 18. 8-Slot Audio/Video Module Standard Configuration

Slot 1	Slot 2	Slot 3	Slot 4	Slot 5	Slot 6	Slot 7	Slot 8
Video TX or RX	Video TX or RX	Video TX or RX	Video TX or RX	Audio TX	Audio TX	Audio RX	Audio RX

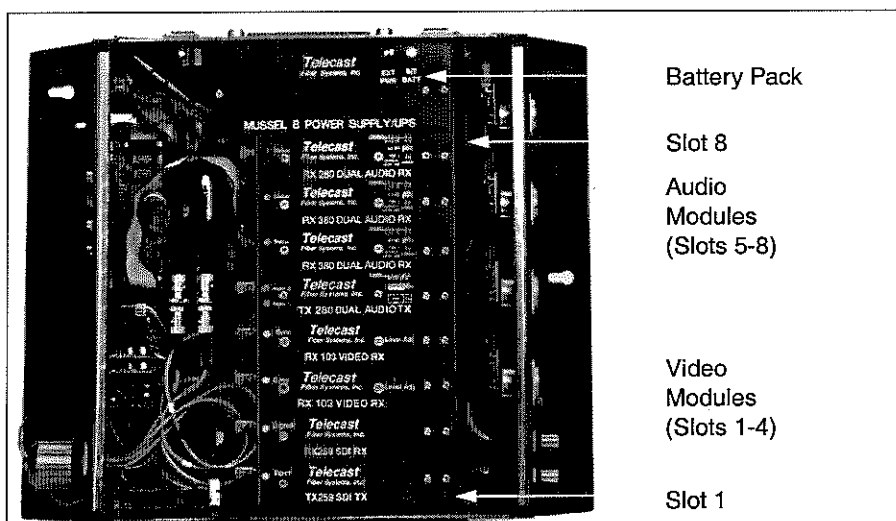

Figure 46. 8-Slot Configuration

Wavelength Division Multiplexing (WDM)

Reconfiguring a system enhanced with WDMs is difficult; remain aware of the wavelength of each device and the direction of the light path.

To change the signal direction:

- Swap the locations of both module sets operating on the single fiber.
- Reconnect the light paths through the WDM according to their wavelength — connect the lower wavelength to leg 1 and the higher wavelength to leg 3.

To determine the wavelength of a module if it is unknown, shine the output of a TX 103 or TX 280 in leg 2 of a WDM; use a light meter or visually check to see if light appears on leg 1 or on leg 3 to determine if the transmitter emits at the lower or higher wavelength.

RX modules suitable for 1300 nm or 1500 nm, single mode or multi-mode, are interchangeable. When swapping devices or adding a light path at a different wavelength, it is possible for the RX 103 (or RX 280) to be interchangeable.

Multiplexing Audio Signals

TX/RX 380 audio slave modules are used for extending the audio capacity from one stereo pair (for one TX/RX 280) to up to four stereo pairs (one TX/RX 280 master and three TX/RX 380 slave modules) without requiring additional fibers. The slave modules may be programmed in various ways, offering the user significant flexibility to distribute audio signals.

Each TX/RX 280 board may be supported by up to three 380 slave modules, maximum. The TX/RX 380 circuit board contains three DIP switches; one switch maximum may be set *on*.

Transmitting Audio in One Direction:

Maintain individual signal paths (for the individual distribution of stereo pairs) by programming each DIP switch according to its module location from the TX/RX 280.

For example, six channels (*three stereo pairs*) transmitting audio signals in one direction requires one TX/RX 280 (master) module set and two TX/RX 380 (slave) pairs.

1. Locate the first TX/RX 380 slave module in the first slot adjacent to the TX/RX 280 master and set DIP switch 1 to the *on* position.
2. Locate the second TX/RX 380 slave module in the second slot adjacent to the TX/RX 280 master (adjacent to the first slave 380 module), and set DIP switch 2 to the *on* position.

Transmitting Audio to Multiple Destinations

The output of audio signals can be split to transmit signals to more than one location, such as for a public announcing system. For example, one line level stereo pair can be input to one TX 280 module to get four line level stereo pairs outputs on the system’s receive end.

1. Set up one TX 280 module to transmit signals to the outputs of one audio RX 280 receiver and up to three RX 380 slave receivers.
2. Set the RX/TX 380 slave module’s three DIP switches to the *off* position to have the same stereo outputs as the RX 280 module.

Note: The TX 380 module functions as a slave only to a TX 280 module and cannot interface with a RX 280 receiver. In addition, an RX 380 module is only a slave to a RX 280 module and cannot interface with a TX 280 transmitter.

Splitting Auxiliary Signals

The Viper system normally consists of two end locations. In some cases, however, the user may require audio, video, intercoms, data and tally from one point to two locations. By using an additional set of TX/RX 280 cards and selecting which signals to enable on each set of cards, the signal can be split, or to take one intercom, one data, and one tally function and send them to two locations. The distribution of audio and video is physically accomplished by the distribution of the optical cables.

Hardware Requirements

To satisfy the multiple distribution points of a split signal, the following are required:

- Three Viper units, either portable or rack mount chassis or a Sidewinder*
- Four sets of TX/RX 280 audio modules
- Three auxiliary I/O boards
- Support hardware, including ribbon cables and submodule boards

The two TX/RX 280 module sets interface with the auxiliary I/O board via the ribbon cables: The ribbon cable has two 30-pin headers to jumper both TX 280s to the TX port of the auxiliary I/O board and the same for both RX 280s. Refer to Figure 47.



* Note: For split-AUX operation, the Sidewinder would need to be in the “A” location. Refer to Figure 47.

AUX DIP switches

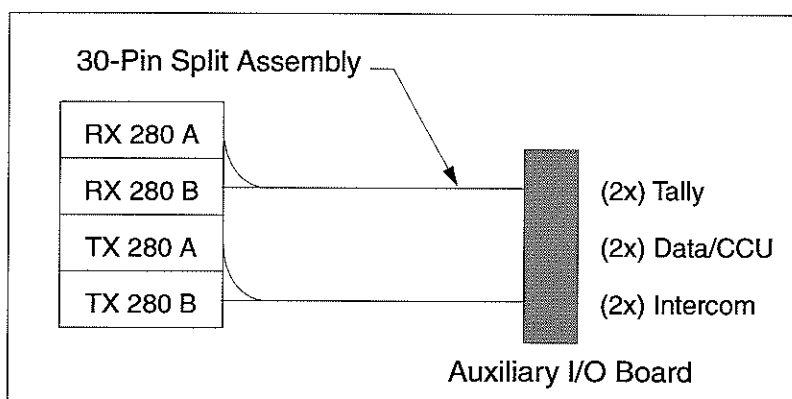

Figure 47. Split Signal Hardware Requirements

Submodule DIP Switch Configuration

Configure the 12-position DIP switch located next to the header on the auxiliary submodule daughter boards as shown in Table 19. This allows the operator to transmit one intercom, one data, and one tally function to each of two locations. All six submodule boards must be set up properly with the switch settings. For normal operations, all DIPS are set to ON.

These switch settings turn off the ports addressing half of the intercom functions and allows two sets of 280 TX/RX modules to share half of the auxiliary I/O board, using fiber to split the 280 TX/RX to two different locations.

The auxiliary submodule boards must be maintained in matched sets once the switches are configured and they have been mounted to the 280 TX/RX modules. Modules with same switch settings must be used in the same optical path or there will be no intercom functions.

Table 19. Auxiliary Submodule Board Switch Settings

DIP Switch	AUX DIP SWITCH POSITIONS			
	Regular Operation		Split Operation (Tx and Rx)	
	TX	RX	Location A	Location B
1 Data1	On	On	On	Off
2 Data1	On	On	On	Off
3 Data2	On	On	On	Off
4 Data2	On	On	On	Off
5 Data3	On	On	Off	On
6 Data3	On	On	Off	On
7 Data4	On	On	Off	On
8 Data4	On	On	Off	On
9 Icom1	On	On	On	Off
10 Icom1	On	On	On	Off
11 Icom2	On	On	Off	On
12 Icom2	On	On	Off	On

Figure 48 illustrates the fiber paths of a split signal operation.

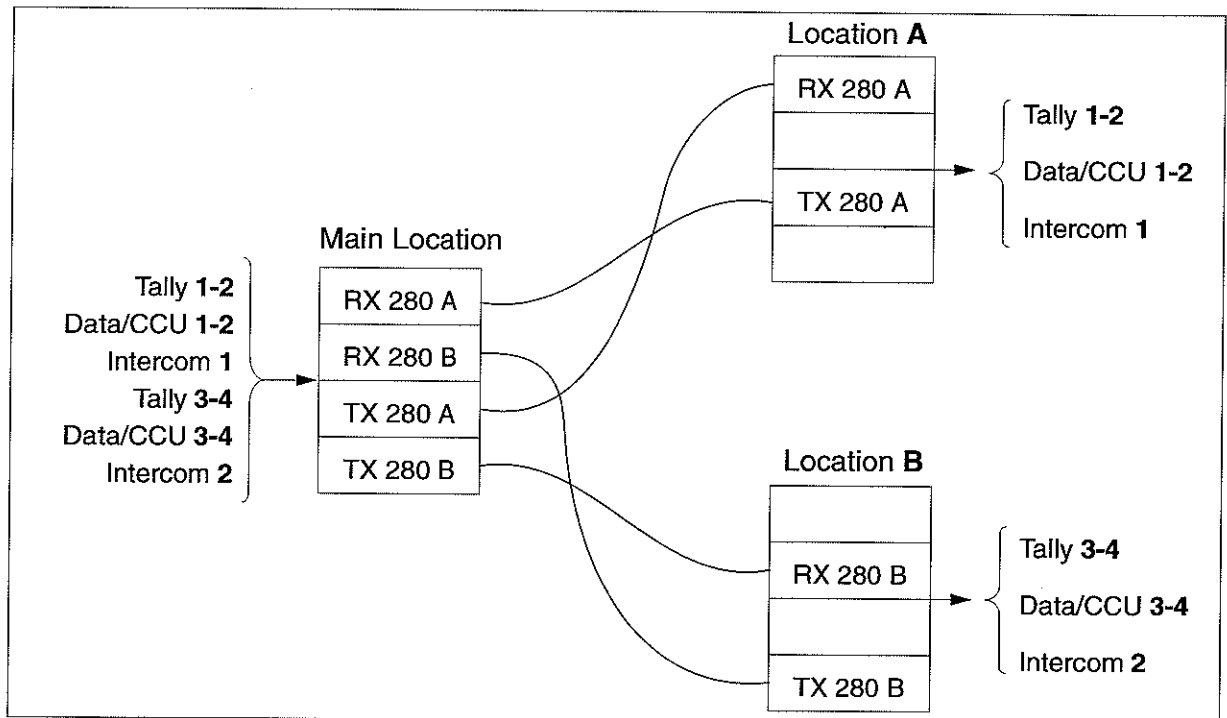

Figure 48. Split Signal Path

Accessory List

The following accessories are available from Telecast:

- Optical power meter kit
- Cable repair kit
- Loop-back cable to localize signals during installation test
- Replacement NiCad battery pack
- Quick-crimp kit to attach ST connectors to fiber optic cable, part number CKIT-ST-QC
- Prefabricated cables built to custom lengths
- Portable fiber reel

Repair

Call Telecast Fiber Systems, Inc. service department at 508-754-4858 for assistance when troubleshooting or reconfiguring the Viper system. To return a unit for repair, you must obtain a return material authorization (RMA) number from Telecast service.

Operating Characteristics

Optical

Table 20. Electro-Optical Characteristics

Operating Wavelength	850nm	1310nm	1550nm
TX Output into Cable (dBm)			
LED (TX103, TX260, TX280)	-17	-14 to -10	-10
Laser (TX280, TX103, TX259, TX 292)		-6 to 0	-10 to 0
RX Sensitivity RX103 (dBm)	-22	-25	-25
RX Sensitivity RX259 (dBm)		-25	-25
RX Sensitivity RX292 (dBm)		-22	
RX Sensitivity RX280 (dBm)	-26	-30	-30

Video

TX/RX103 Module Set (NTSC/PAL)

Interface	RS-170, NTSC, PAL
Input/Output Impedance	75 Ohms
Blanking level clamped to 0 V	1 Vp-p
Freq. Response (30Hz-5MHz)	+/- 0.15db
(-3db point, min.)	9 MHz
Signal to Noise (Wtd) Min/Typ	67db/71db
Differential Gain	< 2%
Differential Phase	< 0.7° for NTSC and 1° for PAL
Luminance Nonlinearity	< 2%
Chrom-Lum Intermod	< 1%
Delay Inequalities	< 10ns for NTSC and <15ns for PAL
Gain Inequalities	+/- 1 IRE
Line Time Distortion	< 0.5 IRE
Field Time Distortion	< 2 IRE p-p
Short Time Distortion	< 3 IRE p-p
Long Time Distortion	< 1 IRE peak
Dynamic Gain, Pict & Sync	< 1%

Viper

TX/RX259 Module Set for 270Mbps SDI Video
Conforms to SMPTE-259M specifications

TX/RX292 Module Set for up to 1.5 Gbps HDTV SDI Video
Conforms to SMPTE-292M specifications

Audio

TX/RX280 & TX/RX380 Module Sets

Digital Transmission	18-bit
Sampling rate (samples/sec)	48k
Input Impedance (balanced)	5 k Ω & 600 Ω
Output Impedance (balanced)	30 Ω
Input Levels (max, Lo Z) dBm	-22, +8 and +18
(max, Hi Z) dBm	-24, +6 and +16
Output Level, line, max.	+18 dBm
Frequency Response (@ +8)	22Hz to 22 kHz +/-0.2 db
Total Harmonic Distortion + noise	
20 Hz to 20 kHz (@ +8)	< 0.05%
1 kHz (@ +18dbm)	< 0.01%
Intermodulation Distortion (SMPTE)	
60 Hz + 3kHz mixed 4:1	<0.04%
Signal to Noise Ratio, unweighted, 20Hz to 20 kHz, RMS	
(ref. to +18 clip reference)	> 90db

Auxiliary

(Requires 2-way TX/RX280 audio paths in Vipers)

Intercom

Interface	2 ch 4-Wire (bal) or 2-Wire (RTS or Clear-Com)
S/N Ratio (ref. to +10 dBm)	70 db

CCU/Data

Interface	RS422, 232 or Sony CCU (e.g. RM-M7 or RM-P3)
Transmission Rate	0 to 150 kBits/sec

Contact Closure

Up to four in 8-module units; one in 4-module units

Port Input Normally HIGH TTL level

Logic 1 = Open remote contacts; connect to ground (Logic 0) to actuate

Port Output Form 1A SPST, "Normally Open" isolated contacts

Mechanical/Electrical/Environmental

<u>Mussel Shell Viper</u>	<u>4-Module</u>	<u>8-Module</u>
Dimensions (HxWxD)	14.5"x8.8"x3"	14.5"x14"x3"
Weight	6 lbs	10 lbs
Power Consumption (per end/loaded)	10 watts	18 watts
Number of Video Slots	2	4
Number of Audio Slots	2	4
Video Connectors	BNC	BNC
Audio Connectors	3-pin XLR, M or F	3-pin XLR, M or F
Intercom Connectors (duplex, on the intercom modules)		
RTS Module (one dual-channel)		One 3-pin XLR, M
Clear-Com (two channels)		Two 3-pin XLR's, M
4-Wire (two channels)		Two 5-pin XLR's M
Optical Connectors		
Standard	ST type or Kellums Grip opening	
Optional	4-pin Military Hermaphroditic receptacle	
Power Connector	4-pin XLR	4-pin XLR
Battery Mount	Anton/Bauer Snap-On Gold Mount Plate	
Input Voltage Range	12 to 24 VDC (30 VDC Max.)	
Operating Temperature Range	-40° to +70° C	
Humidity Range	0 - 95% Non-condensing	
 <u>Rack Mount Viper (V800 or 442)</u>		
Dimensions	16.7"x10.5"x3.5"	
Weight	8 lbs	
Power Consumption (per end/loaded)	18 watts	
Video Connectors	BNC	
Audio Connectors (442 Only)	3-Pin XLR, M or F	
Intercom Connectors (442 Only)	see Intercom Connectors, above	
Data Connectors	DB-9, F	
Power Connector	4-pin XLR	
Input Voltage Range	12 to 24 VDC (30 VDC Max.)	
Operating Temperature Range	-40° to +70° C	
Humidity Range	0 - 95% Non-condensing	

Warranty

LIMITED WARRANTY STATEMENT

Telecast Fiber Systems, Inc. ("Telecast") expressly warrants to Buyer that the Products supplied shall be free from defects in materials and workmanship for a period of 12 months following the date the Products are delivered to Buyer (the "Warranty Period"). Telecast's liability under this limited warranty shall be limited, at its option, to providing refund of purchase price for Products, or replacing or repairing Products shown to be defective either in materials or workmanship. Buyer's sole and exclusive remedy for breach of warranty shall be such refund, replacement or repair.

A claim of defect in materials or workmanship in any Product shall be allowed only when it is submitted in writing to Telecast Fiber Systems, Inc., within seven days after discovery of the defect, and in any event within the Warranty Period. No claim shall be allowed in respect of any Product which has been altered, neglected, damaged or stored in any manner which adversely affects it. In order to obtain service under the terms of this warranty, Distributor's customer or Distributor must notify Telecast of the defect prior to the expiration of the applicable warranty period and obtain a Return Authorization Number from Telecast. In no event may products be returned to Telecast or to Distributor for warranty service without having obtained from Telecast a Return Authorization Number.

This limited warranty applies only to new and unused Products delivered to Buyers located within the United States of America, or to international Buyers if sold through an authorized Distributor organization, and shall not extend to any equipment not manufactured by Telecast Fiber Systems, Inc., even though such equipment may be sold or operated with the Products. In addition, this limited warranty shall be void and of no further force or effect whatsoever if the Product is repaired or modified by any person other than an authorized representative of Telecast Fiber Systems, Inc. without the consent of Telecast Fiber Systems, Inc. This warranty shall not apply to any defect, failure or damage caused by improper use or inadequate maintenance and care. Nor shall this warranty apply to any damage caused in whole or in part by attempts by personnel other than Telecast's personnel, as approved in advance in accordance with the foregoing provisions, to open, install, repair, or service the Product; nor to damage resulting from improper connection with incompatible equipment; nor to damage to a unit which has been modified by personnel other than Telecast personnel.

Products returned to Telecast for warranty service shall be shipped, freight prepaid to Telecast. Telecast will return the repaired product or ship a replacement, freight prepaid, to either Distributor or Distributor's customer, as requested by Distributor's customer, at a location within the United States or, at Telecast's option, to Distributor's location in the case of international sales.

This limited warranty shall also apply to Products that replace defective Products and Products that have been repaired by authorized representatives of Telecast Fiber Systems, Inc., but only for the original Warranty Period. The Warranty Period shall not be extended by reason of defect, or any period of time during which the Product is not available to Buyer because of defects or repairs, without the express written consent of Telecast Fiber Systems, Inc.

EXCEPT FOR THE EXPRESS LIMITED WARRANTY AGAINST DEFECTS IN MATERIALS AND WORKMANSHIP CONTAINED HEREIN, TELECAST FIBER SYSTEMS, INC. MAKES NO WARRANTY OF ANY KIND WHATSOEVER, EXPRESS OR IMPLIED, AND ALL WARRANTIES OF MERCHANTABILITY, FITNESS FOR A PARTICULAR PURPOSE, AND OTHER WARRANTIES OF WHATEVER KIND ARE HEREBY DISCLAIMED BY TELECAST FIBER SYSTEMS, INC. THIS LIMITED WARRANTY SETS FORTH EXCLUSIVELY ALL OF TELECAST FIBER SYSTEMS, INC.'S LIABILITY IN CONTRACT OR OTHERWISE IN THE EVENT OF A DEFECTIVE PRODUCT.

WITHOUT LIMITATION ON THE FOREGOING, TELECAST FIBER SYSTEMS, INC. EXPRESSLY DISCLAIMS ANY LIABILITY WHATSOEVER FOR ANY DAMAGES INCURRED DIRECTLY OR INDIRECTLY IN CONNECTION WITH THE SALE OR USE OF, OR OTHERWISE IN CONNECTION WITH, THE PRODUCT, INCLUDING WITHOUT LIMITATION, LOSS OF PROFITS AND SPECIAL, INCIDENTAL OR CONSEQUENTIAL DAMAGES, WHETHER CAUSED BY NEGLIGENCE OR OTHERWISE, REGARDLESS WHETHER TELECAST HAS BEEN GIVEN ADVANCE NOTICE OF THE POSSIBILITY THEREOF.

THIS WARRANTY IS GIVEN BY TELECAST IN LIEU OF ANY OTHER WARRANTY EXPRESSED OR IMPLIED.

