

DENSITÉ series

DCO-1741 / DCO-1781 2/4 AES Changeover Guide to Installation and Operation

M879-9900-100

16 Sep 2008



Miranda Technologies Inc.

3499 Douglas-B.-Floreani
St-Laurent, Québec, Canada H4S 1Y6

Tel. 514-333-1772

Fax. 514-333-9828

www.miranda.com

© 2008 Miranda Technologies Inc

Safety Compliance Information

Safety Compliance

This equipment complies with:

- CSA C22.2 No. 60950-1-03 / Safety of Information Technology Equipment, Including Electrical Business Equipment.
- UL 60950-1 (1st Edition) / Safety of Information Technology Equipment, Including Electrical Business Equipment.
- IEC 60950-1 (1st Edition) / Safety of Information Technology Equipment, Including Electrical Business Equipment.

CAUTION

These servicing instructions are for use by qualified service personnel only. To reduce the risk of electric shock, do not perform any servicing other than that contained in the operating instructions unless you are qualified to do so. Refer all servicing to qualified service personnel. Servicing should be done in a static-free environment.

Electromagnetic Compatibility

- This equipment has been tested for verification of compliance with FCC Part 15, Subpart B, class A requirements for Digital Devices.
- This equipment complies with the requirements of:
EN 55022 Class A, Electromagnetic Emissions,
EN 61000-3-2 & -3-3, Disturbance in Supply Systems
EN 61000-4-2, -3, -4, -5, -6, -8 & -11 Electromagnetic Immunity

How to contact us:

For technical assistance, please contact the Miranda Technical support centre nearest you:

Americas

Telephone:

+1-800-224-7882

e-mail:

techsupp@miranda.com

Asia

Telephone:

+852-2539-6987

e-mail:

asiatech@miranda.com

Europe, Middle East, Africa, UK

Telephone:

+44 (0) 1491 820222

e-mail:

eurotech@miranda.com

China

Telephone:

+86-10-5873-1814

e-mail:

asiatech@miranda.com

France (only)

Telephone:

+33 (0) 1 55 86 87 88

e-mail:

eurotech@miranda.com

Visit our web site at www.miranda.com

Table of Contents

1	DCO-1741/DCO-1781 2/4 AES Changeover	5
1.1	Introduction	5
1.2	Features	5
1.3	Applications	6
1.4	Block Diagram	8
1.5	Front Card-edge Interface	8
2	Installation	9
2.1	Unpacking	9
2.2	Installation in the Densité frame	9
2.3	Rear Panels	9
2.4	Connections	9
2.5	Using the GPI interface	11
3	Operation	12
3.1	Control options	12
3.2	Card-Edge Status LED	12
3.3	Local control using the Densité frame control panel	13
3.3.1	Overview	13
3.3.2	Menu for local control	13
3.4	Remote control using iControl	14
3.4.1	The iControl graphic interface window	14
3.4.2	The <i>Switch</i> panel	16
3.4.3	The <i>Alarms</i> panel	19
3.4.4	The <i>Reference</i> panel	27
3.4.5	The <i>Status</i> panel	28
3.4.6	The <i>Test Signals</i> panel	28
3.4.7	The <i>C-Link</i> panel	29
3.4.8	The <i>RALM</i> panel	30
3.4.9	The <i>Rear Type</i> panel	31
3.4.10	The <i>Factory / Presets</i> panel	32
3.4.11	The <i>Options</i> panel	35
3.4.12	The <i>Info</i> panel	36
3.4.13	The <i>Alarm Config</i> panel	37
4	Specifications	40
	ANNEX – Local Control Panel User Interface	42

1 DCO-1741/DCO-1781 2/4 AES Changeover

1.1 Introduction

The DCO-1741/1781 is a 2/4 AES changeover. The switch is performed electronically by an internal router. In the event of a power failure, the signal is protected by the relays fitted on the rear module, and this maintains the integrity of the selected signal at the output. The DCO-17n1* card allows switching as a regular router, or alternatively the module can perform an audio silent switch between sources using the silent switch option (software option).

** In this manual, the terminology DCO-17n1 refers to both the DCO-1741 and the DCO-1781. Any text that applies to only one of them will refer to that product specifically*

Input selection can be performed manually or automatically. In automatic mode, the card will perform input selection based on internal signal analysis with alarm parameters, and the status of the inputs. In manual mode, channel selection can be undertaken from the Densité Controller, the iControl software, or simply by using a GPI. A GPI can be connected to an automation system or another device to control input selection. The GPI outputs give status of the selected source, and this can be used to trigger Tallies.

The module provides audio level metering so that an operator can remotely and effectively monitor the signal path using Miranda's iControl facility monitoring and control system.

Finally, the DCO-17n1 cards can work in conjunction with the HCO-1821 (HD/SD/ASI changeover). In multiple card operation, the DCO-17n1 can operate in "audio follow video" mode where the video and audio changeovers are seen as a unique 2x1 switching system

1.2 Features

- DCO-1741 has 2 AES on each input
- DCO-1781 has 4 AES on each input
- Electronic switching with relay backup (on rear module)
- Automatic mode using internal signal analysis with alarm parameters
- Manual change over by local frame controller, iControl, iControl Solo, GPI or RCP-100
- Alarm reporting to iControl facility monitoring and control system
- GPI in & out (IN 1, IN2, AUTO, BYPASS)
- Optional silent switch function
- Frame reference input
- Monitoring Switching Bridge (MSB) compatible
- Audio level meter streaming
- Can work with the HCO-1821 video changeover

1.3 Applications

Application 1a: Master Control

In this application, the DCO-17n1 is used upstream of the master control switcher. It is switching between the main audio feed and an audio apology slide. This configuration has been seen several times, particularly in Europe (France 5...)

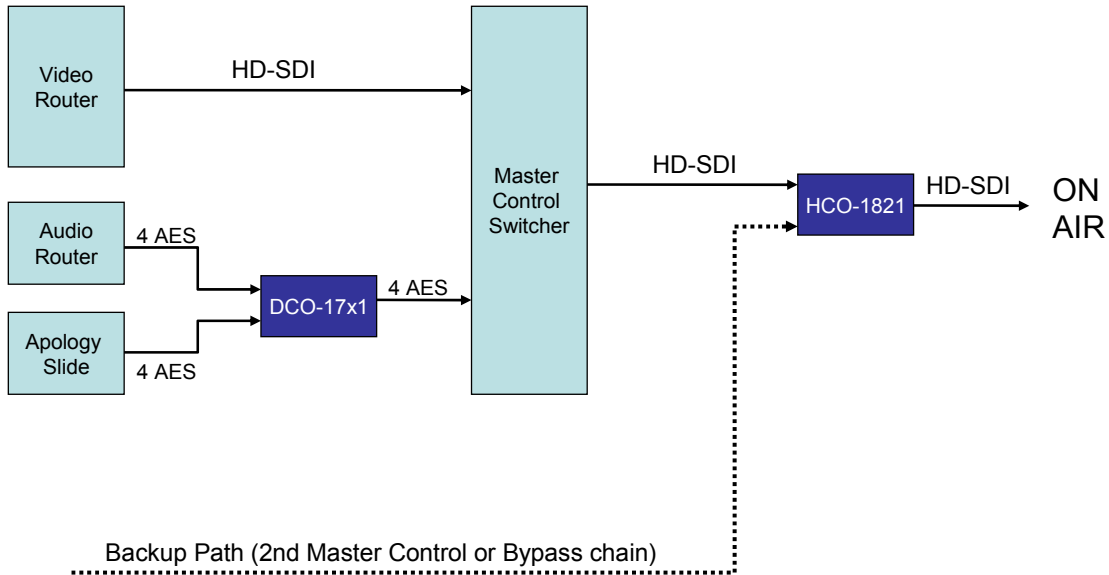

Application 1b: Master Control (AC3 encode)

In this variant, the DCO-17n1 is used to switch between main and backup audio to feed the station output AC3 encoder.

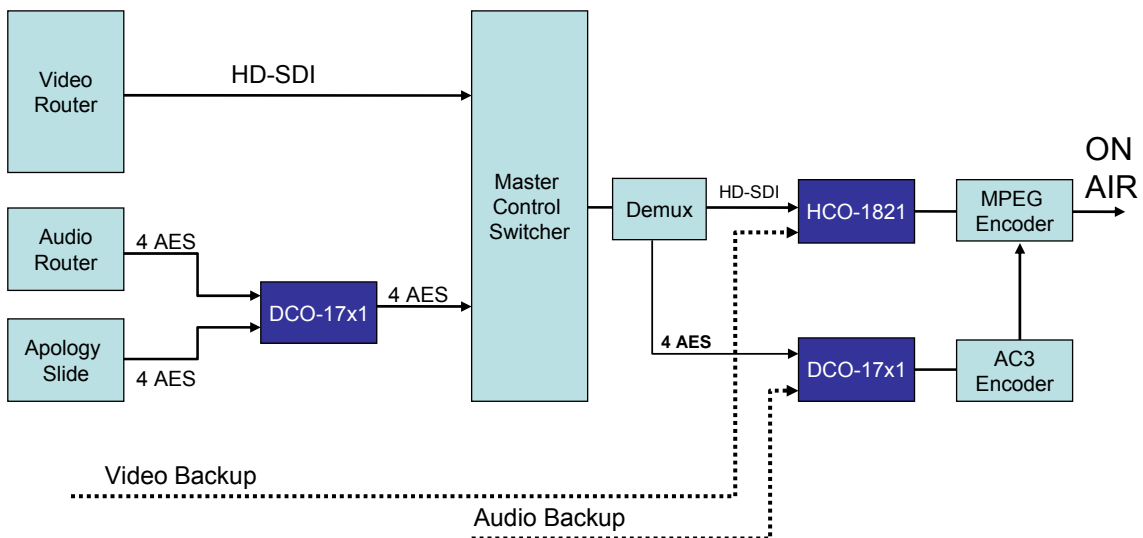

Application 2a: Incoming feeds

Some IRDs work with discrete audio. The DCO-17n1 is used to switch between the main and backup audio feeds. The resulting audio is then muxed with the main video, before feeding the station router.

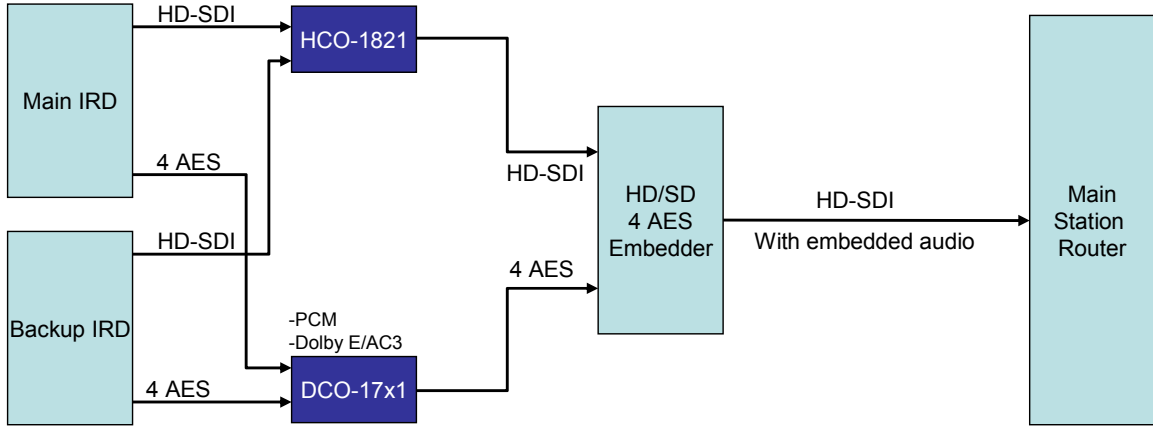

Application 2b: Incoming feeds (Dolby E decode)

In this variant, the DCO-17n1 is used to switch between main and backup audio to feed the station input Dolby E decoder.

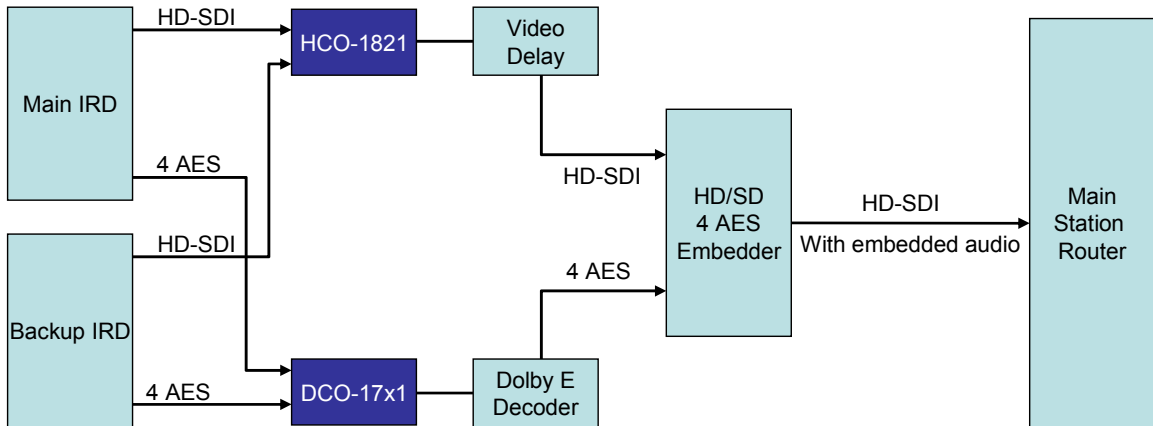

Application 3: Audio only

Radio stations can use this card in an audio only environment with the sale functions.

1.4 Block Diagram

The following block diagram shows the functionality of the DCO-17n1.

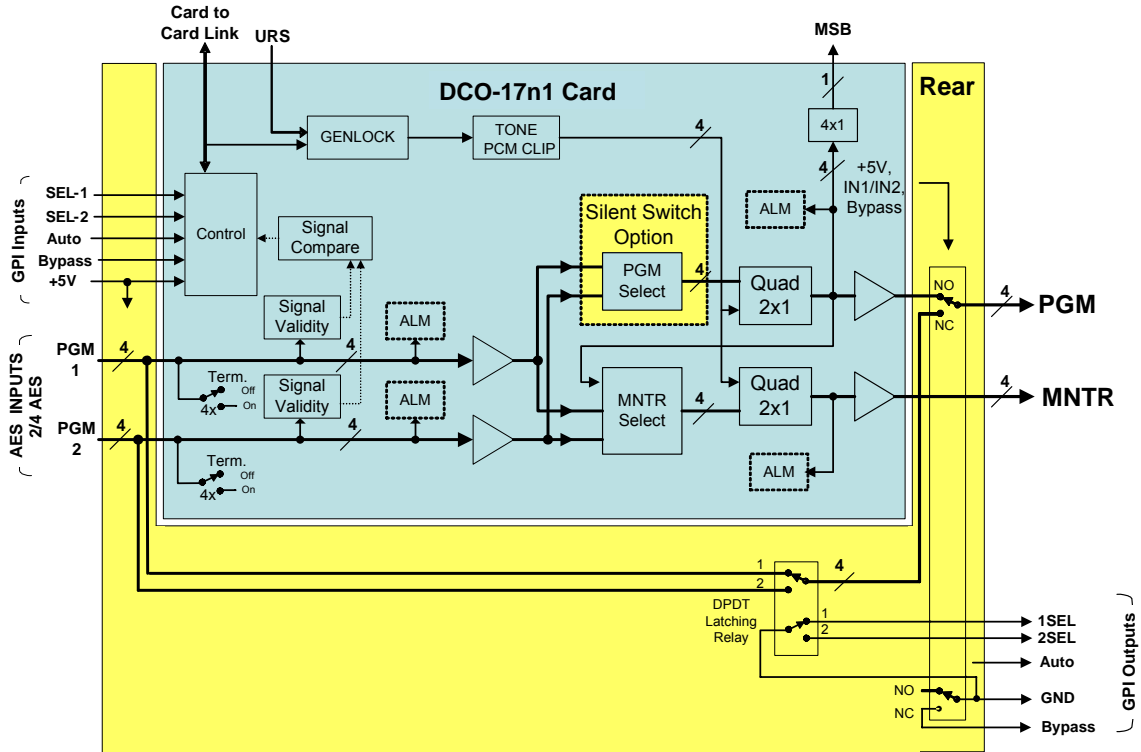

Figure 1-1 Functional block diagram of the DCO-17n1 and its Rear Panel

1.5 Front Card-edge Interface

The front card-edge of the DCO-17n1 incorporates three elements:

- Status LED (see section 3.2)
- Select Button (see section 3.3)
- C-LINK connector (see section 3.4.7)

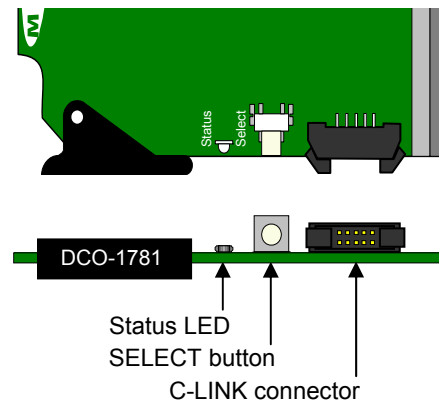

Figure 1.2 Front card-edge layout

2 Installation

2.1 Unpacking

Make sure the following items have been shipped with your DCO-17n1. If any of the following items are missing, contact your distributor or Miranda Technologies Inc.

- DCO-1741 or DCO-1781 Integrated Receiver and Decoder
- DCO-17n1-75-DRP-R or DCO-17n1-110-DRP-R Rear Panel (see figure 2.1)

2.2 Installation in the Densité frame

The DCO-17n1 and its associated rear connector rear panel must be mounted in a Densité 2 frame. It is not necessary to switch off the frame's power when installing or removing the card. See the Densité 2 frame manual for detailed instructions for installing cards and their associated rear panels.

Extender panels for Densité 2 rear module and card are needed to fit the card in a Densité 3 frame.

2.3 Rear Panels

The DCO-17n1 has multiple inputs and outputs, and making space for all the necessary connectors at the rear of the frame requires a double-width rear panel.

With the double-width rear panel installed, the DCO-17n1 must be installed in the right-most of the two slots covered by the panel in order to mate with the panel's connectors.

If it is placed in the wrong slot, the front panel LED will flash red. Move the card to other slot for correct operation. No damage will result to the card should this occur.

2.4 Connections

The rear panel connections are as follows:

- **PGM 1 & PGM 2 AES Inputs** – Signal inputs on a 26-pin connector
- **PGM & PVW AES Outputs** - Signal outputs on a 26-pin connector

The DCO-17n1-110-DRP-R is AES3 compatible and offers balanced connections for inputs and outputs. An optional terminal block adaptor exists under the reference Miranda **#NSH26M**.

The DCO-17n1-75-DRP-R is AES3-id compatible and offers unbalanced connections for inputs and outputs. An optional break-out cable adaptor exists under the reference Miranda **#BOC-DA26-8BNC-1**.

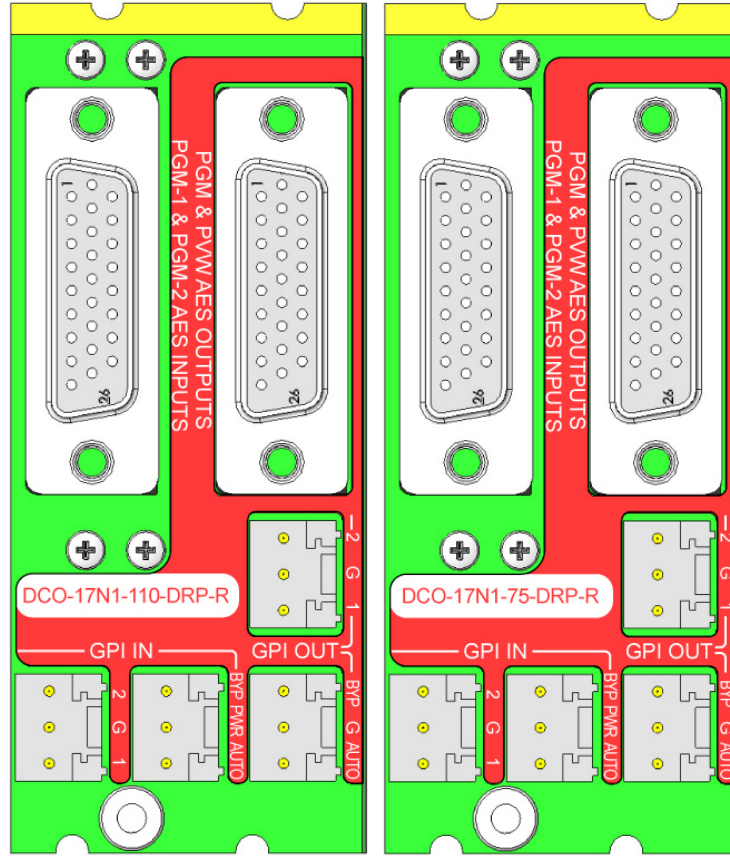

Figure 2.1 DCO-17n1 Rear Panels

GPI IN and GPI OUT connectors

The rear panel of the DCO-17n1 includes a GPI interface that allows control of the switch process.

When constructing and using an external GPI box, be aware of the following:

1. The DCO-17n1 card monitors the external power supply voltage on the GPI input. If the voltage is less than 4V (per relay datasheet), an alarm will be raised.
2. When a GPI INPUT is triggered while the card is operating in auto mode, the card changes to manual mode and switches to the input selected by the GPI.
3. DO NOT TRIGGER BOTH GPI INPUTS AT THE SAME TIME OR ALLOW THE TRIGGER PULSES TO OVERLAP, AS DAMAGE TO THE RELAY MAY RESULT.
4. A GPI trigger pulse should have a duration of at least 40 ms.

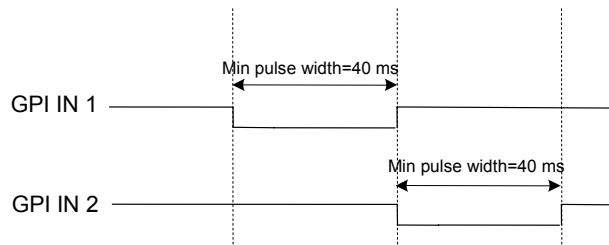

Figure 2.2 GPI trigger pulse timing

2.5 Using the GPI interface

The following functions are available using the GPI interface:

- Trigger the GPI-IN-1 or GPI-IN-2 pin to select that input.
- Trigger the AUTO-IN or BYPASS-IN pin to select that mode
- Read the GPI-OUT-1 and GPI-OUT-2 pins to identify which output is selected
- Read the AUTO-OUT and BYPASS-OUT pins to determine whether either of these modes is in operation. The BYPASS-OUT pin will also indicate the Passive Audio Path.

Table 1 Rear Panel GPI Connectors – Pin Assignment and Functionality

WECO connector	Pin label	GPI direction	GPI function	Trigger
GPI-IN	1	IN	IN-1 select	Edge; contact closure to ground
	G	GND		
	2	IN	IN-2 select	Edge; contact closure to ground
GPI-IN	AUTO	IN	AUTO mode select	Edge; contact closure to ground
	PWR	External +5V		
	BYP	IN	BYPASS mode select	Edge and level
GPI-OUT	1	OUT	OUT-1 selected	
	G	GND		
	2	OUT	OUT-2 selected	
GPI-OUT	AUTO	OUT	AUTO mode selected	
	G	GND		
	BYP	OUT	BYPASS mode or Passive Audio Path selected	

External GPI power box

An external GPI box is available. This box provides power to the rear module in case of power loss to the frame, or card removal.

- Using this box, the relays in the rear module can be operated to switch the audio feeds in either of these cases

3 Operation

3.1 Control options

The DCO-17n1 can be controlled in two different ways:

- The local control panel and its push-buttons can be used to move through a menu of parameters and to adjust parameter values (see section 3.3).
- Miranda’s iControl system can be used to access the card’s operating parameters from a remote computer, using a convenient graphical user interface (GUI). (see section 3.4)

3.2 Card-Edge Status LED

The status monitor LED is located on the front card-edge of the DCO-17n1, and is visible through the front access door of the DENSITÉ frame. The chart shows how the various error conditions that can be flagged on the DCO-17n1 affect the LED status.

- If a cell in the chart is gray, the error condition cannot cause the LED to assume that status
- If more than one LED status is possible for a particular error condition, the status is configurable. See Section 3.4.13 for details.
- The factory default status is shown by a ⚙, and forced status by an X

The LED will always show the most severe detected error status that it is configured to display, and in the chart error severity increases from left to right, with green representing no error/disabled, and flashing red the most severe error.

Alarm Name/Error Report	Green	Yellow	Red	Flashing Red	Flashing Yellow	Description
Card booting		X				After power-up, the led becomes yellow for a few seconds.
Hardware/System Failure				X		Major hardware or system failure. In some cases, the error log will show the reason
No Rear Detect				X		As per Densité standard
AES Carrier			⚙			No Lock, Parity, CRCC, Validity, Not 48 KHz.
PCM / Non PCM		⚙				PCM, Dolby-E, AC-3, Others
Audio Alarms		⚙				Overload, Max Level, Min Level, Silence, Low Dynamics, Imbalance, Phase, Stereo Width.
Metadata Alarms		⚙				Dialnorm, PGM Config, ACMod
Switch alarms		⚙				Backup input, Bypass mode
GPI Power box		⚙				External +5 V DC
Card system			⚙			Multiple card configuration.
Test Signal		⚙				With the Densité frame’s control panel.
Local control					X	

3.3 Local control using the Densité frame control panel

3.3.1 Overview

Push the SELECT button on the DCO-17n1 card edge (Section 1.5) to assign the local control panel to operate the DCO-17n1. Use the control panel buttons to navigate through the menu, as described below.

All of the cards installed in a Densité frame are connected to the frame's controller card, which handles all interaction between the cards and the outside world. There are no operating controls located on the cards themselves. The controller supports remote operation via its Ethernet ports, and local operation using its integrated control panel.

The local control panel is fastened to the controller card by a hinged connector, and when installed is located in the front center of the frame, positioned in front of the power supplies. The panel consists of a display unit capable of displaying two lines of text, each 16 characters in length, and five pushbuttons.

The panel is assigned to operate any card in the frame by pushing the SELECT button on the front edge of that card.

- Pushing the CONTROLLER button on the control panel selects the Controller card itself.
- The STATUS LED on the selected card flashes yellow.

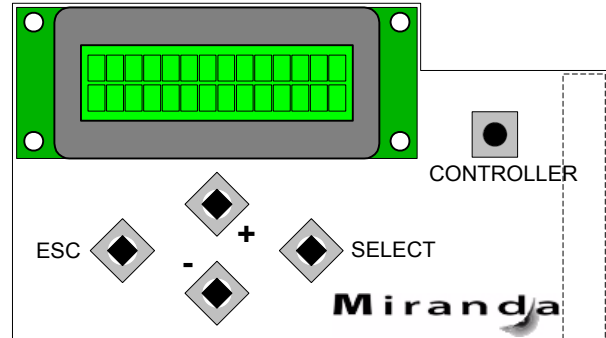

Figure 3.1 Densité Frame local control panel

The local control panel displays a menu that can be navigated using the four pushbuttons located beneath the display. The functionality of the pushbuttons is as follows:

[+] [-] Used for menu navigation and value modification

[SELECT] Gives access to the next menu level. When a parameter value is shown, pushing this button once enables modification of the value using the [+] and [-] buttons; a second push confirms the new value

[ESC] Cancels the effect of parameter value changes that have not been confirmed; pushing [ESC] causes the parameter to revert to its former value.

Pushing [ESC] moves the user back up to the previous menu level. At the main menu, [ESC] does *not* exit the menu system. To exit, re-push the [SELECT] button for the card being controlled.

If no controls are operated for 30 seconds, the controller reverts to its normal standby status, and the selected card's STATUS LED reverts to its normal operating mode.

3.3.2 Menu for local control

The DCO-17n1 has operating parameters which may be adjusted locally at the controller card interface.

- Press the SELECT button on the DCO-17n1 front card edge to assign the Densité frame's local control panel to the DCO-17n1
- Use the keys on the local control panel to step through the displayed menu to configure and adjust the DCO-17n1.

The complete menu structure is shown in the Annex to this document, beginning on page 42.

3.4 Remote control using iControl

The operation of the DCO-17n1 may be controlled using Miranda's iControl system.

- This manual describes the control panels associated with the DCO-17n1 and their use.
- Please consult the iControl User's Guide for information about setting up and operating iControl.

In iControl Navigator or iControl Websites, double-click on the DCO-17n1 icon to open the control panel.

3.4.1 The iControl graphic interface window

The basic window structure for the DCO-17n1 is shown in figure 3.2. The window identification line gives the card type (DCO-1741 or DCO-1781) and the slot number where the card installed in its Densité frame.

There are three main sections in the window itself, identified in figure 3.2:

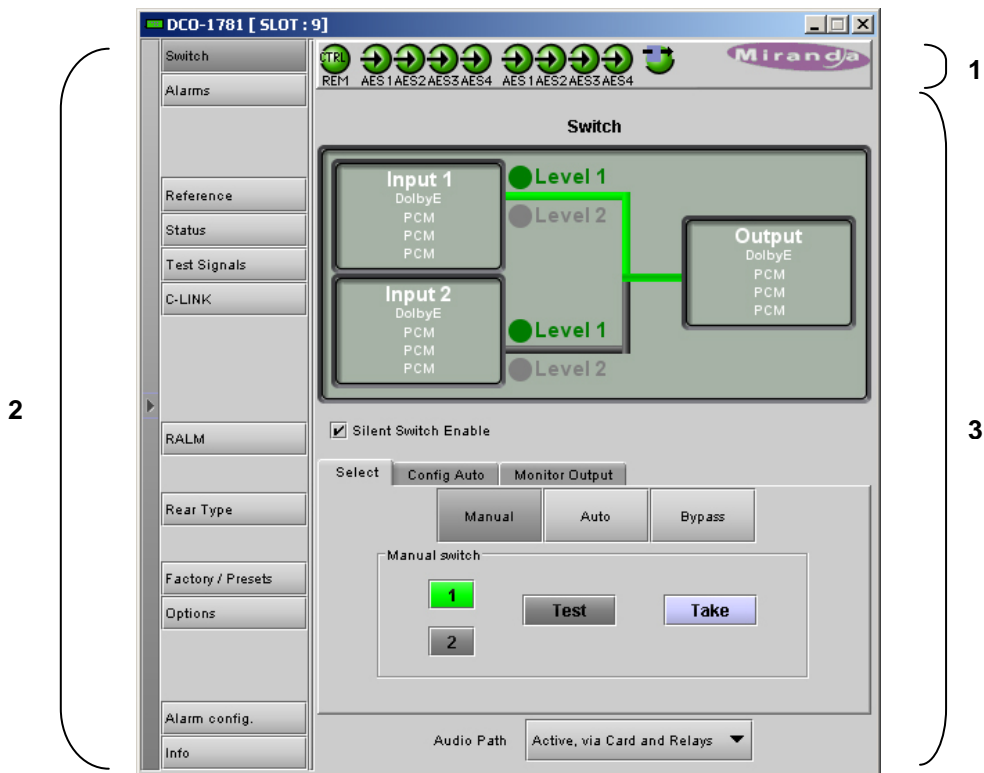









Figure 3.2 DCO-1781 iControl graphic interface window

1. The Status Icon area shows a series of ten icons that report the status of some card parameters. The table shows the various forms that may appear.

Icon #1 – Manual Card Configuration	
 (green)	Remote card control activated. The iControl interface can be used to operate the card
 (yellow)	Local card control active, The card is being controlled using the Densité frame control panel, as described in section 3.3. Any changes made using the iControl interface will have no effect on the card.
Icon #2 through #5 – Input 1: AES 1 through 4 status	
 (green)	Status OK.
 (red)	Any enabled alarm; this icon is not Alarm level dependant.
Icon #6 through #9 – Input 2: AES 1 through 4 status	
 (green)	Status OK
 (red)	Any enabled alarm; this icon is not Alarm level dependant.
Icon #10 – Audio Path Status	
 (green)	Active, via card and relays
 (yellow)	Passive, via relays only

Move the mouse over an icon and a status message appears below the icon providing additional information. If there is an error, the error status message appears in the message area without mouse-over.

- If there are multiple errors, the error messages cycle so all can be seen
 - The icon whose status or error message is shown is highlighted with a mauve background
2. The left-hand side of the panel contains a series of buttons that control the contents of the main window (section 3). Click on one to access the indicated controls. The selected button is highlighted (darker) and the main panel heading matches the button name.

- This section contains the main operating controls and displays for managing the DCO-17n1's feature set. The contents are selected by clicking a button on the left-hand side of the screen.

The left side of the window, containing section 2, can be hidden or revealed by clicking the arrow icon at the center of the left side border.

Each of the panels associated with the groups accessed from the buttons in Section 2, and shown in Section 3, is described individually in the following sections.

3.4.2 The Switch panel

The graphic at the top of the panel identifies the input that is currently selected, and indicates the validity of both inputs by the color of their icons. Some details of each input's AES contents are shown

Silent Switch Enable

Select this checkbox to enable the Silent Switch feature of the DCO-17n1, allowing clean transitions between the two audio inputs.

- The Silent Switch option must be activated in order for this feature to be available.
- See Section 3.4.8 for more details.

The DCO-17n1 has three modes of switch operation, selected from the Select tab in the Switch control panel.

Two different signal paths exist: "Active, via Card and Relays" or "Passive, via Relays only", selected using the pulldown at the bottom of the panel.

- Some features like Output Test signals or use of the Reversion mode are reserved to the Active Audio Path.
- The choice of the Passive Audio Path allows the DCO-17n1 to behave like a probe, with minimum interaction between the audio signals and the card.

1. Manual switch

Manually switches the DCO-17n1 output between three possible sources: input 1, input 2, or Test.

The Audio Path can be active or passive.

- Click the Manual button. The three possible sources are shown on the left, with the current source in green.
- Click on a different source. The selection shows flashing red, and the Take button is activated, appearing solid red.

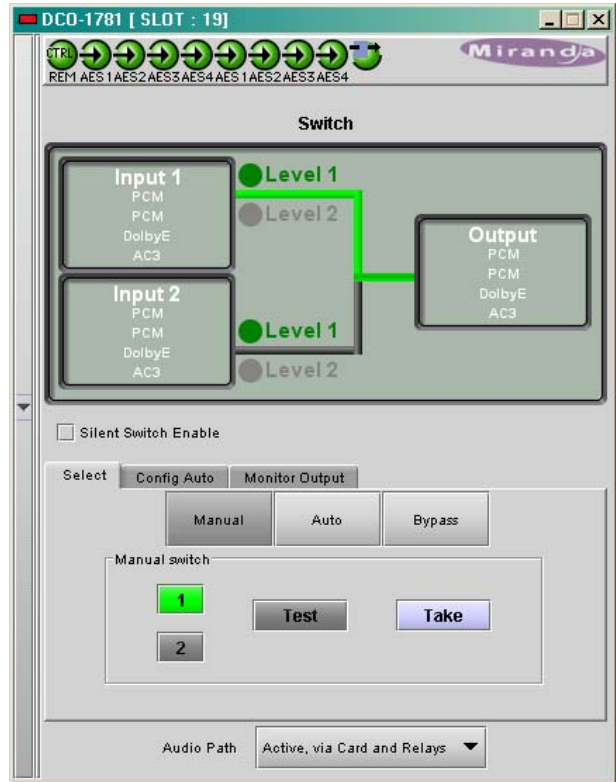

Figure 3.3 The Switch panel



Figure 3.4 The Manual Switch Controls

- A countdown (from 10 seconds) underneath the Take button shows how long the Take button will remain active before it times out.
- Click the Take button while it is active to switch the DCO-17n1 output over to the new source

To remove the Test, just click on the Test button. Access the Test Signals panel to configure the test signals, they will be routed to the card outputs only in Manual mode and Active audio Path. The other choice for the audio path is “Passive, via relays only”.

2. Auto switch

Auto switch uses Alarms based on the status of both inputs to determine whether the other input or a programmed failure response should be selected.

The Audio Path can be active or passive.

- Click the Auto mode button in the *Select* tab to activate the Auto mode.

Auto mode operation:

- If Input 1 fails with an alarm level of higher priority than input 2, the DCO-17n1 will automatically switch over to Input 2
- If both inputs have an AES Carrier alarm level of 1, the DCO-17n1 will play an Apology message, or revert to Silence. The failure response is set in the Test Signals panel (Section 3.4.6), Reversion Mode section.

Select the *Config Auto* tab to select the Auto Mode functionality:

In the *Switch Mode* box, select:

- *Switch To*: switches to the input 2 (if it is valid) when the alarm conditions trigger a switch, and remains there until a manual reconfiguration.
- *Switch and Return*: switches to input 2 (if it is valid) when the alarm conditions trigger a switch, and then switches back to input 1 after a predetermined interval, counted from the time the input 1 returns to a valid state. Use the slider at the bottom of the tab to set this interval (0 to 59 seconds, 1 to 10 minutes)
- *Toggle*: Switches to the other input (if it is valid), each time an error is detected on the current input.



Figure 3.5 The Auto Mode

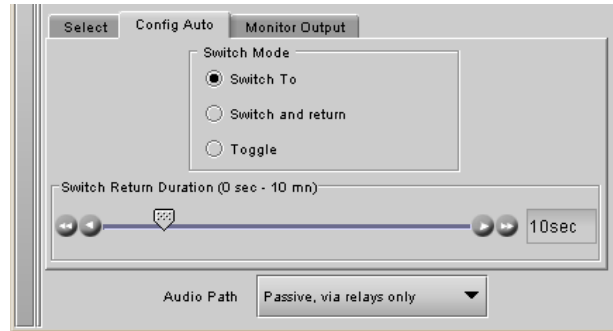

Figure 3.6 The Config Auto Controls

3. Bypass

Bypass triggers relays located on the rear panel to connect the selected inputs directly to the outputs. The bypassed DCO-17n1 card is electrically disconnected from the signal system, and can be removed from the frame with no discontinuity in the signal path. The Audio Path is forced to *Passive, via relays only*.

When the DCO-17n1 is in Bypass:

- The audio analyses are valid for both channels.
- No signal is sent to the MSB in the frame
- The audio Path is forced to “passive, via relays only”

NOTE: Setting the DCO-17n1 in BYPASS mode or in Passive Audio Path ensures no disruption in the signal when the card is removed and reinserted in the *Densité* frame.

Monitor Output tab

Use this tab to select the source for the Monitor output

Auto: opposite input from that selected for the Program output

Input 1: input 1

Input 2: input 2

Program: the same as the Program output

Monitor Test: This checkbox acts as a master for the four outputs. When checked, the selected Test signals will be routed to the Outputs. The Test signals may be assigned for each Monitor Output (Test signals page, under the Monitor Output section).

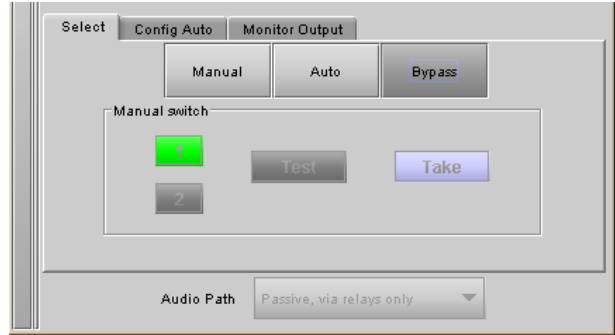

Figure 3.7 The Bypass mode

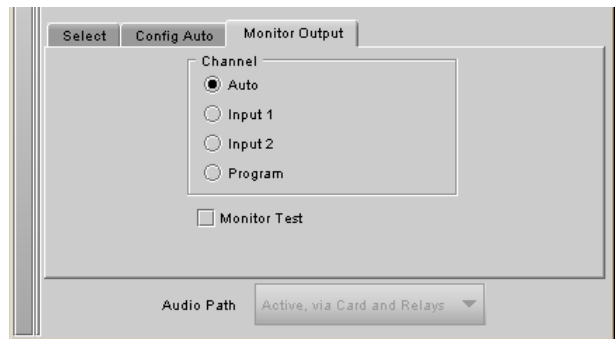

Figure 3.8 Switch panel - Monitor Output tab

3.4.3 The Alarms panel

The DCO-17n1 continuously monitors the condition and status of the input signals it is processing. The information is used to decide whether the input must be switched in Auto mode. It is also used to flag the status of the card in the iControl system.

In general:

- A number of parameter values are continuously tested against user-defined thresholds or for presence/absence.
- Each parameter test is assigned a Level, to determine the extent to which it contributes to the changeover decision.

Many alarms can be enabled or disabled using the *Enable* checkbox in their control panel (see below).

An alarm that is enabled:

- Contributes to the switch decision process based on its LEVEL.
- Is reflected in the device status as reported to iControl (LEVEL has no bearing on this)

Each alarm is assigned a LEVEL that determines its contribution to the switch decision process. Possible levels are:

- 1 – highest significance
- 2 – lower significance
- OFF – not used in the switch decision process

Some alarms are arbitrarily assigned as Level 1 and cannot be changed by the user (e.g. No Carrier present is always a Level 1 alarm). Their Enable checkbox is ticked, and greyed-out.

Other alarms have a pulldown in their control panel that allows the user to set the level.

The DCO-17n1 uses the most significant alarm detected for an input as the alarm level for that input, and then uses the truth table on the right to decide whether to switch from input 1 to input 2 and back.

The various tabs in the Alarms panel give access to all alarm-related settings.

- Each tab shows a list of the parameters for which alarms exist, and show the current settings for each, for both inputs.
- Click on one to select it, and the control panel for adjusting that parameter appears at the bottom of the screen.

INPUT 1		INPUT 2		OUTPUT:
Alarm level		Alarm level		SELECT INPUT #
1	2	1	2	
<input type="radio"/>	<input type="radio"/>	<input checked="" type="radio"/>	<input checked="" type="radio"/>	1
<input type="radio"/>	<input checked="" type="radio"/>	<input type="radio"/>	<input type="radio"/>	2
<input type="radio"/>	<input checked="" type="radio"/>	<input type="radio"/>	<input checked="" type="radio"/>	1 or last
<input type="radio"/>	<input checked="" type="radio"/>	<input checked="" type="radio"/>	<input checked="" type="radio"/>	1
<input checked="" type="radio"/>	<input checked="" type="radio"/>	<input type="radio"/>	<input type="radio"/>	2
<input checked="" type="radio"/>	<input checked="" type="radio"/>	<input type="radio"/>	<input checked="" type="radio"/>	2
<input checked="" type="radio"/>	<input checked="" type="radio"/>	<input checked="" type="radio"/>	<input checked="" type="radio"/>	1 or last

= Alarm at this level
 = No Alarm at this level
 = Don't care

INPUTS – Enable Channels

Click on a checkbox to enable or disable the whole Input/AES channel.

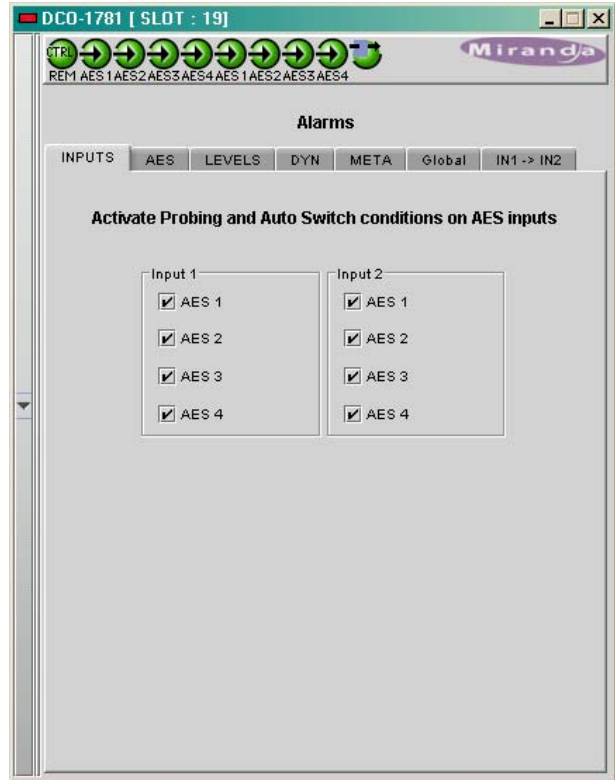

Figure 3.9 Alarms panel – Inputs tab

AES – AES Carrier alarm

This error is always ENABLED.

The LEVEL may be set to 1, 2 or OFF. The factory default value is level 1.

Use the checkboxes to select the AES Carrier parameters that will be checked to determine whether an error is present:

- No Lock – always enabled
- Parity
- CRCC
- Validity
- Not 48 KHz.

When “Apply To All” is checked, any modification of a parameter will be applied to the same parameter of all other channels. This checkbox is common to all Alarms tabs.

Use the slider to set the duration for which the error must continuously exist before the alarm is flagged.

Use the LED Color pull-down to choose the color that will be displayed by the status LED on the card edge when an AES Carrier error is detected.

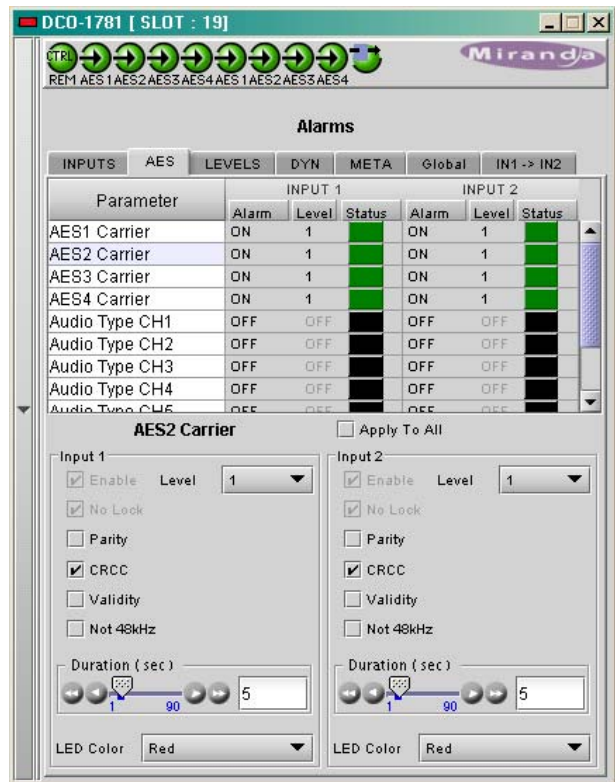

Figure 3.10 AES Carrier alarm configuration

AES – Audio Type alarm

The user sets the expected format(s) for each input using the checkboxes in the control panel. The DCO-17n1 compares this with the actual format detected at the input, and flags an error if they do not match.

Formats that can be checked are:

- PCM
- Dolby-E
- Dolby Digital AC3
- Non PCM

This error can be Enabled using the checkbox, and the level set to 1, 2 or OFF.

Use the *Duration* slider to set the duration for which the error must continuously exist before the alarm is flagged.

Use the LED Color pull-down to choose the color that will be displayed by the status LED on the card edge when a Format Mismatch error is detected.

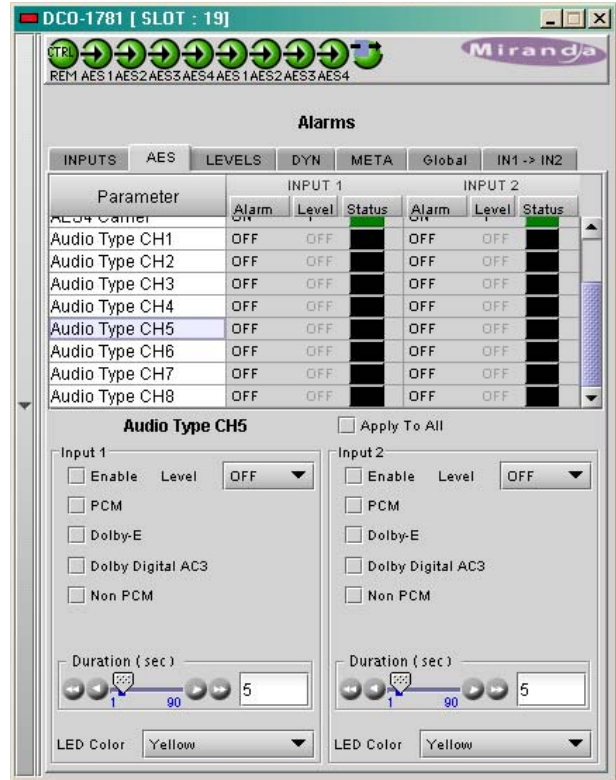

Figure 3.11 AES Audio Type alarm configuration

Levels – Overload alarm

This error is generated if signal peaks are detected greater than a threshold value over a specified duration. The integration time is 10 ms and the peak value is latched for 1 s.

This alarm is generally used to avoid signal clipping. In that case, the threshold is set a few dB under the maximum level of signal path and the duration is set to the minimum.

- Use the two sliders, or type values directly into the data boxes.

This error can be Enabled using the checkbox, and the level set to 1, 2 or OFF.

Use the LED Color pull-down to choose the color that will be displayed by the status LED on the card edge when an Overload error is detected

NB – this error applies only to PCM audio.

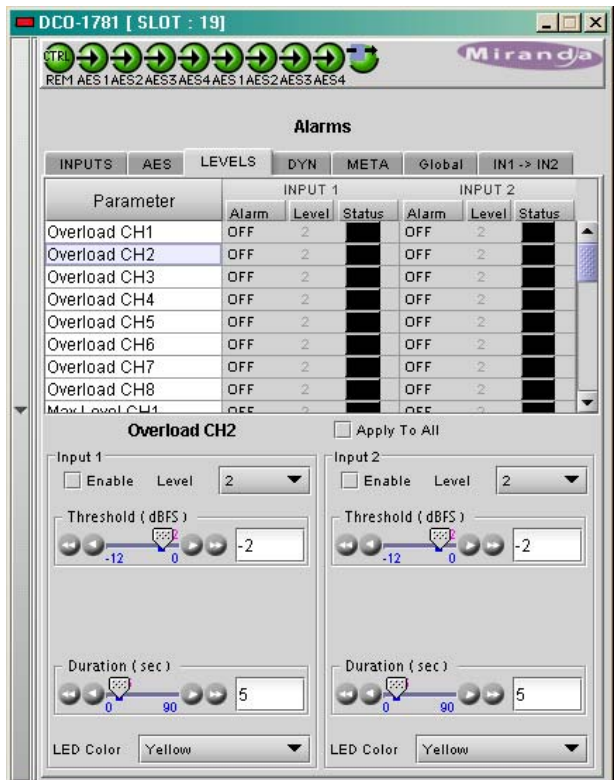

Figure 3.12 Levels Overload alarm Configuration

LEVELS – Max Level alarm

This error is generated if the signal level in the channel is continuously greater than a threshold value over a specified duration. The integration time is 300 ms.

This error can be Enabled using the checkbox, and the level set to 1, 2 or OFF.

This alarm is generally used to detect too high an average level. In that case, the threshold is set a few dB above the nominal level and the duration is set to a medium time:

- Threshold (dBFS) – sets the signal level (between -20 and 0 dBFS) above which a MAX LEVEL error will be considered to have been detected.
- Duration (sec) – sets the time interval over which MAX LEVEL must be continuously detected before the error is flagged.

Use the LED Color pull-down to choose the color that will be displayed by the status LED on the card edge when a Maximum Level error is detected.
NB – this error applies only to PCM audio.

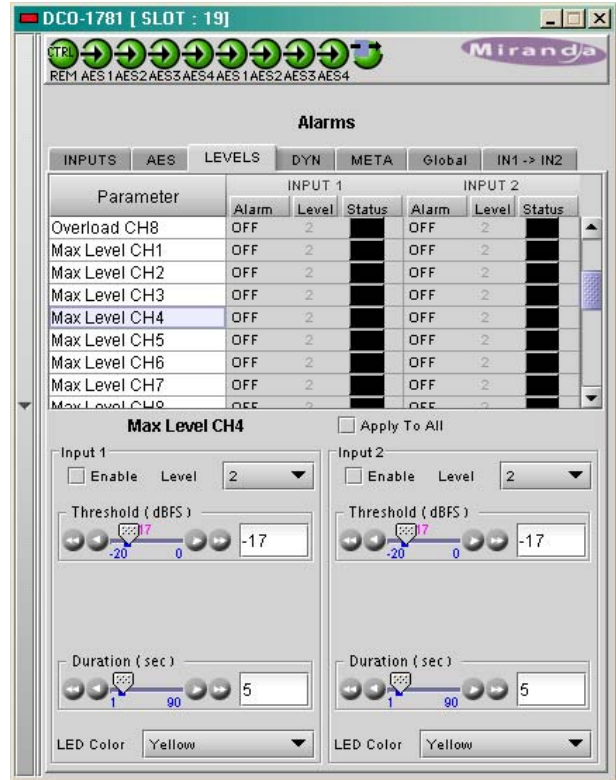

Figure 3.13 Maximum Level alarm Configuration

LEVELS – Min Level alarm

This error is generated if the signal level in the channel is continuously lower than a threshold value over a specified duration. The integration time is 300 ms.

This error can be Enabled using the checkbox, and the level set to 1, 2 or OFF.

This alarm is generally used to detect too low an average level. In that case, the threshold is set a few dB under the nominal level and the duration is set to a medium time:

- Threshold (dBFS) – sets the signal level (between -40 and -20 dBFS) below which a MIN LEVEL error will be considered to have been detected.
- Duration (sec) – sets the time interval over which MIN LEVEL must be continuously detected before the error is flagged.

Use the LED Color pull-down to choose the color that will be displayed by the status LED on the card edge when a Minimum Level error is detected.
NB – this error applies only to PCM audio.

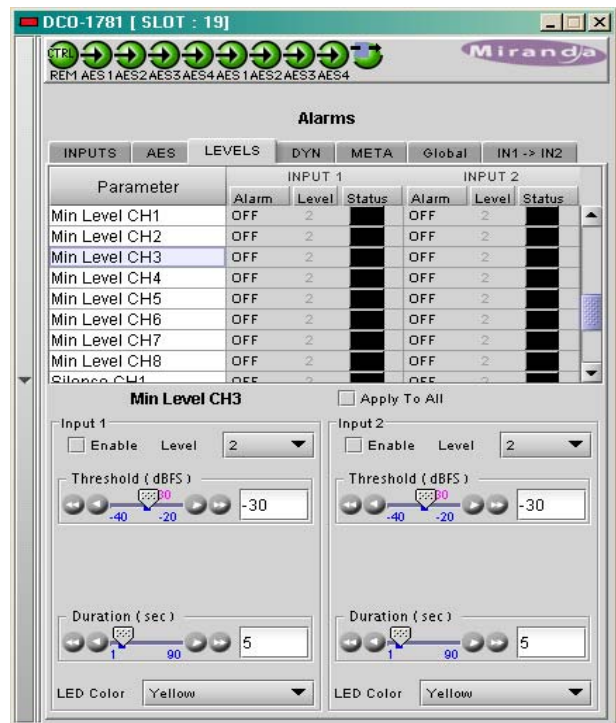

Figure 3.14 Minimum Level alarm Configuration

LEVELS – Silence alarm

This error detects that the level of the signal remains under a fixed threshold for longer than a specified duration. The integration time is 10 ms.

This error can be Enabled using the checkbox, and the level set to 1, 2 or OFF.

This alarm is generally used to detect a signal absence. In that case, the threshold is set a few dB below the expected minimum level and duration is set according to the sort of program, a few seconds for radio, a few tens of seconds for TV:

- Threshold (dBFS) – sets the signal level (between -80 and -40 dBFS) below which a SILENCE error will be detected.
- Duration (sec) – sets the time interval over which SILENCE must be continuously detected before the error is flagged.

Use the LED Color pull-down to choose the color that will be displayed by the status LED on the card edge when a Silence error is detected.

NB – this error applies only to PCM audio.

DYN – Low Dynamics alarm

This error is generated if the difference between the maximum and the minimum average levels is less than a fixed threshold for longer than a specified duration. It may be used to detect a signal with a fixed level, like a test tone. The integration time is 300 ms.

This error can be Enabled using the checkbox, and the level set to 1, 2 or OFF.

This alarm is generally used to detect a low value, or the absence, of dynamics often related to a broadcasting problem. A strong noise, a constant test signal or a heavy compressed modulation is detected by this analysis. In that case, the threshold is set to a few dB and the duration is set to a medium time (ex: 8 dB, 30 sec):

- Threshold – sets the value between 1 and 20 dB below which Low Dynamics will be detected.
- Duration (sec) – sets the time interval over which Low Dynamics must be continuously detected before the error is flagged.

Use the LED Color pull-down to choose the color that will be displayed by the status LED on the card edge when a Low Dynamics error is detected.

NB – this error applies only to PCM audio.

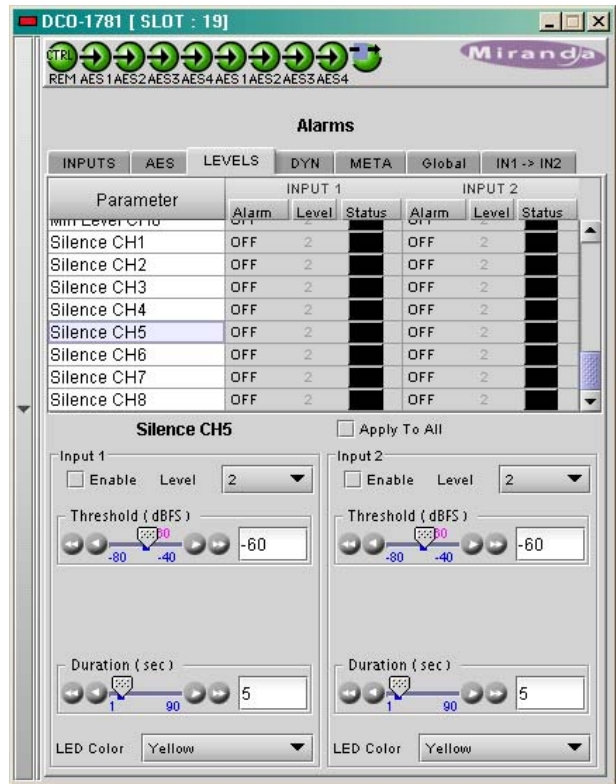

Figure 3.15 Silence alarm configuration

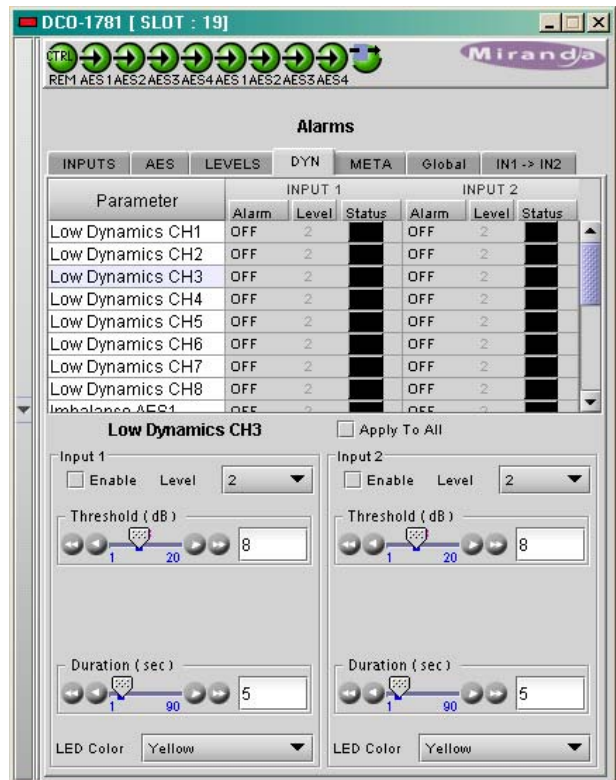

Figure 3.16 Low Dynamics alarm configuration

DYN –AES Imbalance alarm

This error is generated if the difference in level between two channels remains above a fixed threshold for longer than a specified duration. The integration time is 300 ms.

This error can be Enabled using the checkbox, and the level set to 1, 2 or OFF.

This alarm is generally used when the source is stereo to detect an imbalance between the two channels. This problem is often related to a defective wiring or an incorrect level adjustment. In that case, the threshold is set to a few dB and the duration is set to a medium time (ex: 5 dB, 10 sec):

- Threshold – sets the signal level difference (between 0 and 10 dB) above which an AES Imbalance will be considered to have been detected.
- Duration (sec) – sets the time interval over which an AES Imbalance must be continuously detected before the error is flagged.

Use the LED Color pull-down to choose the color that will be displayed by the status LED on the card edge when an Imbalance error is detected.

NB – this error applies only to PCM audio.

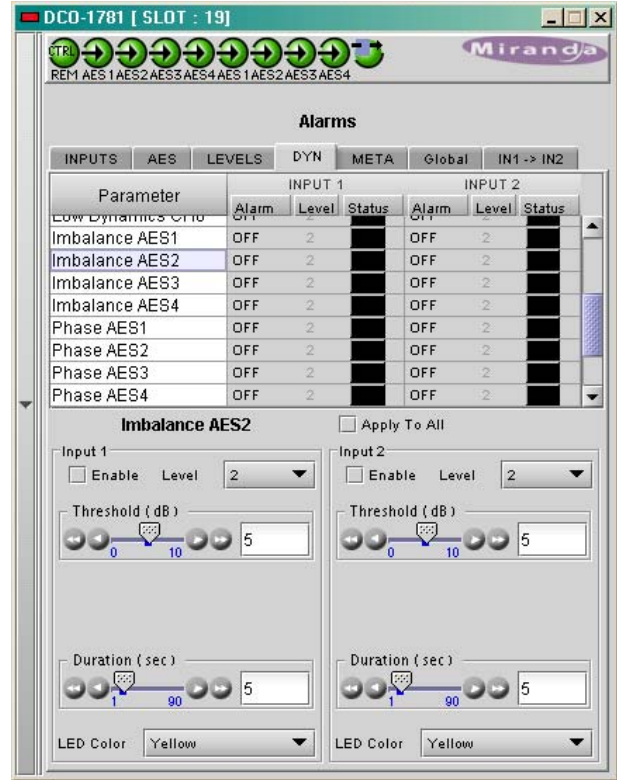

Figure 3.17 Imbalance alarm configuration

DYN – AES Phase alarm

This error is generated if the phase difference between two channels remains above a fixed threshold for longer than a specified duration.

This error can be Enabled using the checkbox, and the level set to 1, 2 or OFF.

This alarm is generally used to detect a phase error often related to a wrong wiring or to a recording problem. The threshold is set according to the sort of program and the duration is set to a medium time (ex: - 0.6, 10 sec).

- Threshold – sets the phase difference (between 95 and 180 degrees) above which a Phase error will be considered to have been detected.
- Duration (sec) – sets the time interval over which a Phase error must be continuously detected before the error is flagged.

Use the LED Color pull-down to choose the color that will be displayed by the status LED on the card edge when a Phase error is detected.

NB – this error applies only to PCM audio.

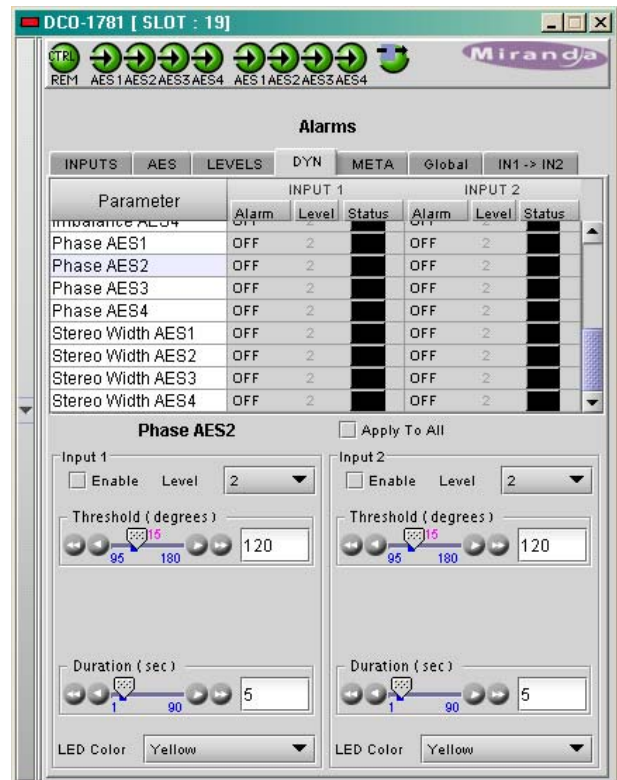

Figure 3.18 Phase alarm Configuration

DYN – AES Stereo Width alarm

This error is generated if the stereo width remains below a fixed threshold for longer than a specified duration. The integration time is 10 ms.

This error can be Enabled using the checkbox, and the level set to 1, 2 or OFF.

This alarm is used to detect a monophonic program when the signal is supposed to be stereo. As a noisy channel can add some extra width to the signal, the threshold allows adjusting the precision of the analysis. With a low-noise signal, use a low threshold value (e.g. 2, 15 sec), and with a noisy signal use a high threshold value (e.g.: 8, 15 sec).

- Threshold – sets the value (between 0 and 10) above which an AES Stereo Width error will be considered to have been detected.
- Duration (sec) – sets the time interval over which a Stereo Width error must be continuously detected before the error is flagged.

Use the LED Color pull-down to choose the color that will be displayed by the status LED on the card edge when a Stereo Width error is detected.

NB – this error applies only to PCM audio.

META – Program Config alarm

This error can be generated under two circumstances:

- If a Dolby-E stream is detected, its Program Configuration parameter is compared to the selected value and an error is generated if they are different.
- If an AC-3 program is detected, its Channel Mode parameter is compared to the selected value and an error is generated if they are different.

This error can be Enabled using the checkbox, and the level set to 1, 2 or OFF.

- Program – the pull-down selects the Dolby-E Program Configuration or the AC-3 Channel Mode to be used as a reference.
- Duration (sec) – the slider sets the time interval over which a Program Config error must be continuously detected before the error is flagged.

Use the LED Color pull-down to choose the color that will be displayed by the status LED on the card edge when a Program Config error is detected.

NB – this error applies only to Dolby-E or AC-3 (Dolby Digital) programs.

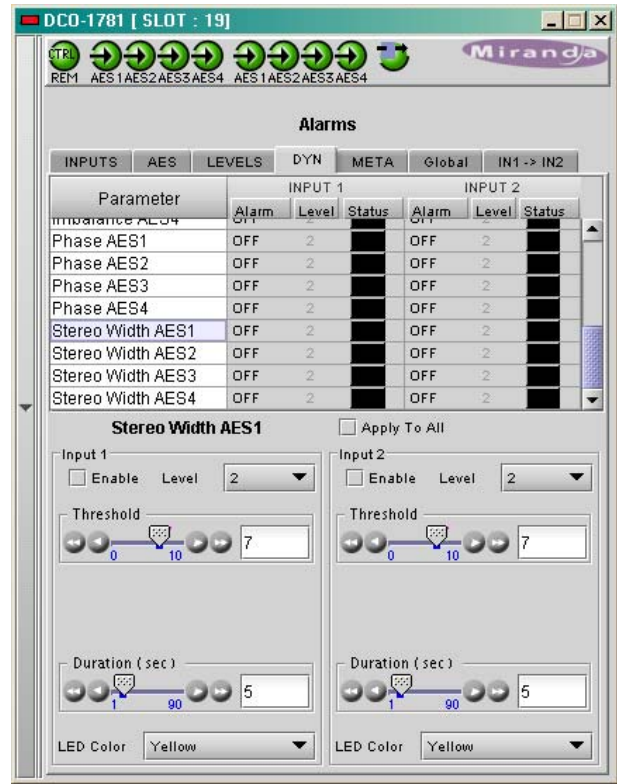

Figure 3.19 Stereo Width alarm Configuration

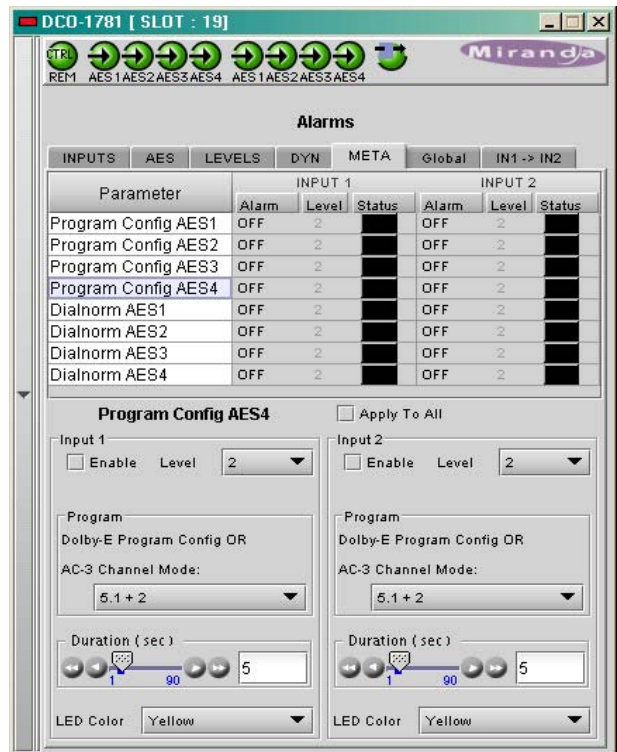

Figure 3.20 Program Config alarm Configuration

META – Dialnorm alarm

This error can be generated under two circumstances:

- If a Dolby-E stream is detected, an error is generated if the Dialnorm of the first program parameter falls outside a range of values defined by upper and lower thresholds.
- If an AC-3 program is detected, an error is generated if its Dialnorm parameter falls outside a range of values defined by upper and lower thresholds.

This error can be Enabled using the checkbox, and the level set to 1, 2 or OFF.

The user sets the detection parameters for this error using three sliders:

- Lower Threshold – set the lowest value in the allowable range of values for the Dialnorm parameter
- Upper Threshold – set the highest value in the allowable range of values for the Dialnorm parameter
- Duration (sec) – sets the time interval over which a Dialnorm error must be continuously detected before the error is flagged.

Use the LED Color pull-down to choose the color that will be displayed by the status LED on the card edge when a Dialnorm error is detected.

NB – this error applies only to Dolby-E or AC-3 (Dolby Digital) program

Global alarms

The parameters found under the Global tab do not have individual control panels.

These alarms DO NOT CONTRIBUTE to the switch decision process, but are included in the card status.

Five parameters are included in the Global Alarms list:

- Backup input – LED remains Red as long as the backup input (input 2) is selected – valid in AUTO MODE only
- Bypass Mode – indicates whether the DCO-17n1 is in *Bypass* mode
- GPI Power Box – detects whether a GPI box is supplying power to the GPI connector on the rear panel. Displays an error when the alarm is enabled and no power is detected.
- Card System – indicates a CLINK problem; the detected multiple card configuration does not correspond to the selected.
- Test Signal – indicates that at least one of the output channels is in Test mode, with the output selected as Silence, Test or Apology.

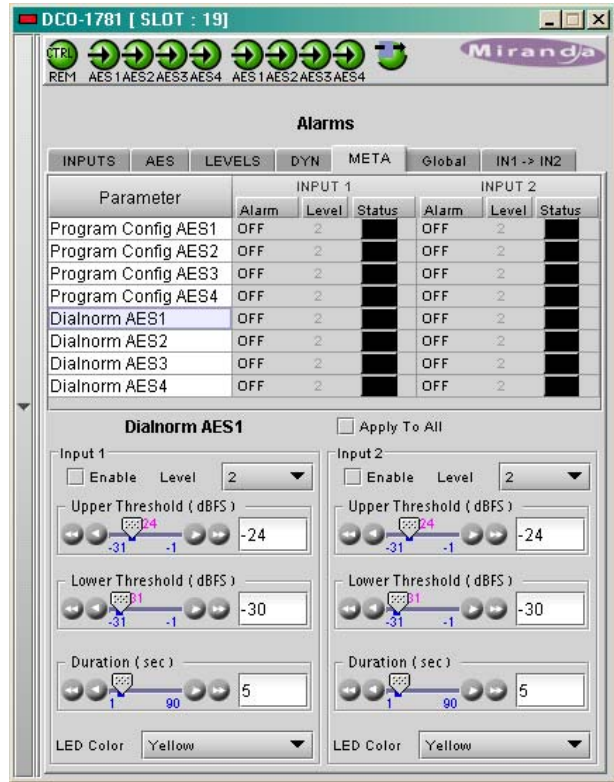

Figure 3.21 Dialnorm alarm Configuration



Figure 3.22 Global alarms Configuration

Each parameter has two configurable features:

- *Enable* – click in the *Enable* check box to include the alarm in the card status
- *LED Color* - click on the color name in the LED Color column and a pulldown will appear offering the choice of Green, Yellow, Red or Flashing Red. The current status is shown by the colored icon in the right-hand column

In1->In2

Click the checkbox to force all alarm parameters for input 2 to match those set for input 1.

- When this is selected, only one set of alarm parameters is displayed for both inputs.
- When the checkbox is deselected, the alarm parameters for input 2 revert to their previous values, i.e. as they were before the checkbox was selected.

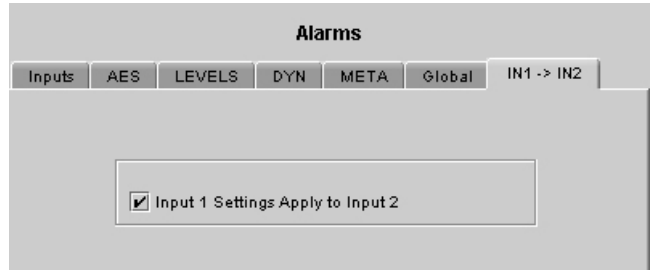

Figure 3.23 IN1 →IN2 alarm configuration

3.4.4 The Reference panel

The reference panel displays the status of the various reference signals that may be used by the DCO-17n1, and provides a means to select the desired reference.

This reference is used to time the output signals in case of loss of inputs when the card generates test tones or apology signals.

The Reference grid shows the references that may be available on the vertical axis:

- 48 KHz AES input:
- URS – slot 10
- URS – slot 20
- Free Run

Beside each are three items:

- *Current* – the icon is green if this reference is currently selected as the card reference
- *Presence* – the icon is green if this reference is currently present and valid (Free Run is always a valid option, so there is no icon here)
- *Desired* – use the radio buttons to select an individual reference, or to select Auto at the top of the column. Auto selects the first reference it detects in the Presence column, beginning at the top. In the absence of an external reference or URS, it will place the card in Free Run mode.

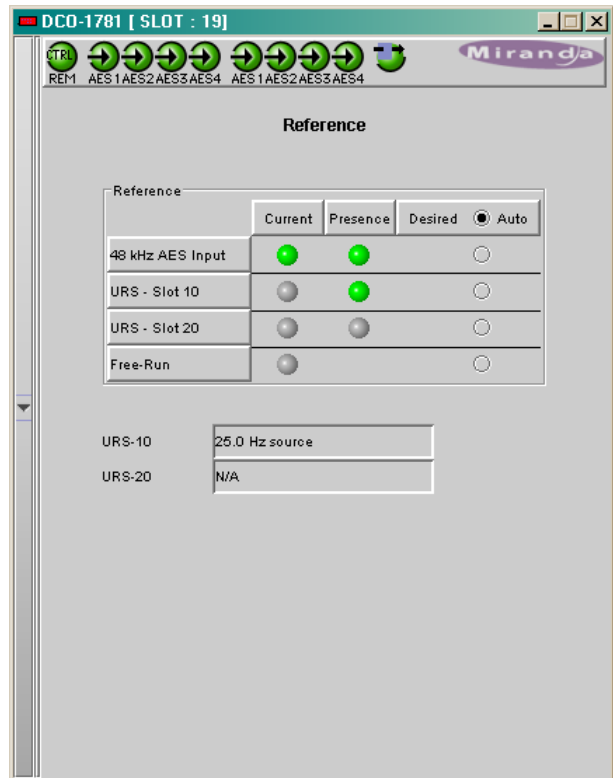

Figure 3.24 The Reference Panel

3.4.5 The Status panel

This panel reports the status of the audio inputs to the DCO-17n1 card.

For each of the eight inputs, it reports:

- Audio Type (color coded highlight for easy identification):
- Carrier Status:
- Mode: if relevant
- Dialnorm value: if relevant

Enable checkboxes:

- Click on a checkbox to enable or disable the Input/AES channel.

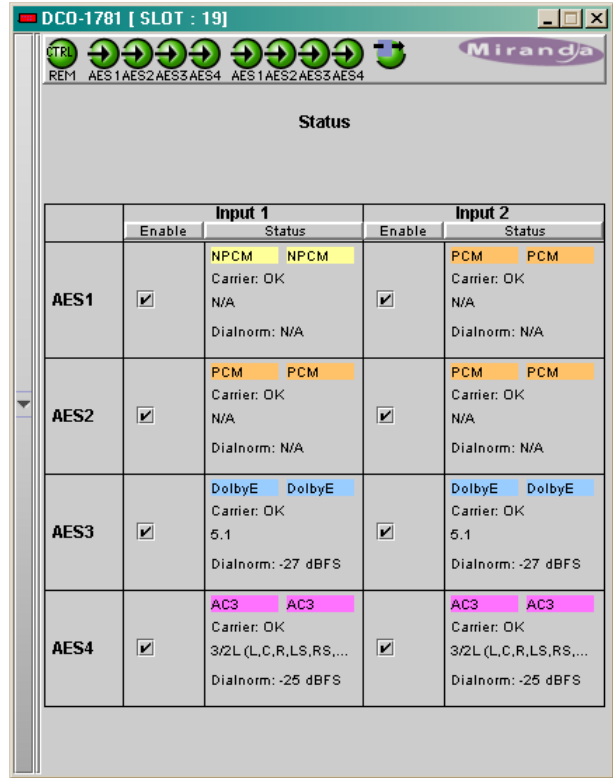

Figure 3.25 The Status Panel

3.4.6 The Test Signals panel

This panel allows choice and selection of a Test audio signal for each output.

Reversion Mode:

Click in the checkbox to enable/disable the reversion mode of each of the four program outputs.

Use the radio buttons to select the output that will be triggered in the event that a valid audio program is not available:

- Silence
- Apology 1
- Apology 2

Test Channels Selection:

Use the pull-downs to select the audio that will be output on the four Program Outputs, and the four Monitor Outputs, when TEST is selected as the output in the switch panel:

- OFF
- EBU
- Apology 1
- Apology 2

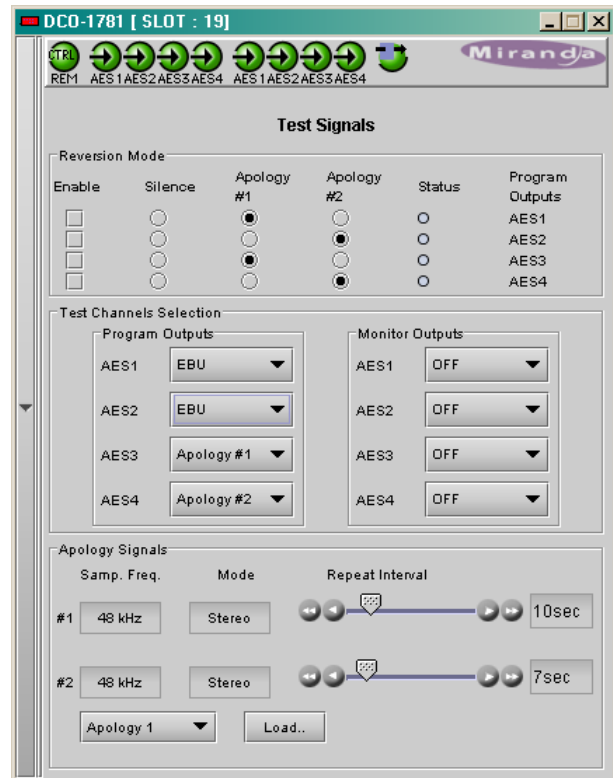

Figure 3.26 The Test Signals Panel

Apology Files

Each of the two Apology Signals is provided with status boxes that report its sampling frequency and mode (mono / stereo), and a slider / data box that allows the repeat interval to be set (seconds from 0 to 59, then minutes from 1 to 10).

To load an Apology Signal, use the pulldown to select either *Apology 1* or *Apology 2*, then click the *Load...* button. An *Open* window will appear; browse to select an appropriate audio file and click *Open* to load it onto the DCO-17n1.

- The format for the Apology audio file should be: uncompressed Wave, 24 kHz or 48 kHz sample frequency, 16 bits word length. The file should be smaller than 2.162 Mbytes.

The duration of an apology message will be between 11 s, for a 48 KHz stereo signal, and 44 s for a 24 KHz mono signal.

3.4.7 The C-Link panel

This feature is not implemented with firmware 100 and will be part of a later release.

C-LINK Config:

Click on a radio button to select the operating configuration of this DCO-17n1 card.

- **Not connected to C-LINK Bus** – when the **C-LINK** is disabled, it is not possible to detect other attached cards in the system.
- **Slave 1 of Video Card** – used for a two-card system when the other card is an HCO.
- **Slave 1 of Video Card, Slave 2 is present** – used for a three-card system, with a HCO and another DCO-17n1 configured as Slave2.
- **Slave 2 of Video Card, Slave 1 is present** – used for a three-card system, with a HCO and another DCO-17n1 configured as Slave1.
- **Master** – the card is standalone, or used as a master for another DCO-17n1 configured as Slave. This mode is not available when a video card is attached to the **C-LINK**.
- **Slave of Audio Master Card** – used for a two-card system when the other card is a DCO-17n1 configured as Master.

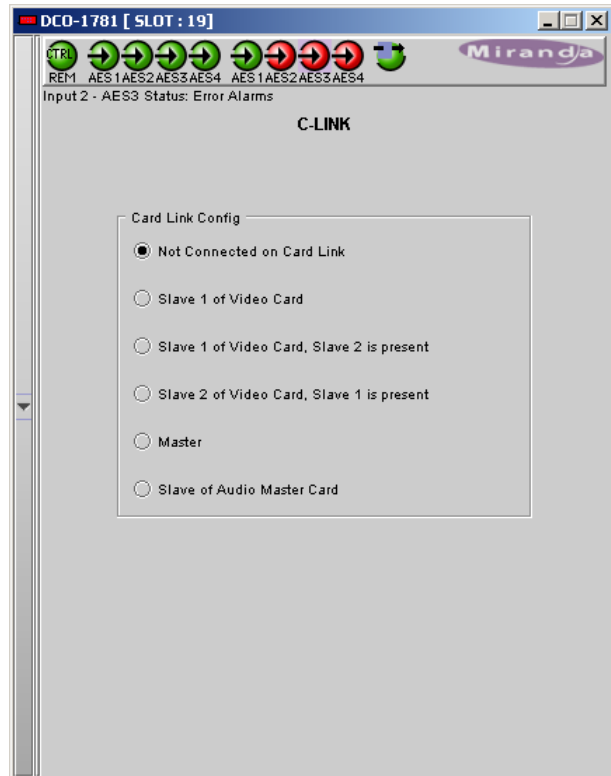

Figure 3-27 C-LINK panel configuration

3.4.8 The RALM panel

This Remote Audio Level Meters (RALM) feature allows distant supervision of 16 audio levels. The 8 AES pairs are selectable amongst the input and output signals of the DCO-1781. This feature is limited to 4 AES pairs for a DCO-1741.

RALM tab

Player (AES x) – each checkbox turns the local player ON or OFF for the pair of channels.

Reset Counters – reset the overload counters to zero. The counters are located on top of each meter. See Overload Cursor in the Meter Ballistics section for more information.

Input selectors – the 16 channels are split in two groups with an input selector for each group. It is possible to display simultaneously either both inputs, both outputs, or one input and one output.

Moreover, any group of meters can be affected to the monitoring of a Dolby-E signal. They will display the VU or Peak metering information included in the AES without Dolby-E decoding; the phase is not available in this case.

Streams (AES x) – To limit the data flow required by the meters, each pair of meters can be turned ON and OFF independently. Each checkbox controls the transmission for 2 channels of RALM data to the iControl server.

The **Speed** pull-down affects the refresh rate, the default value is fast.

The **Metering** pull-down has an effect only with a VU meter ballistics selected. The Loudness selection adds an A-weighting filter to the measurement process and modifies the integration time to 600 ms instead of 300 ms for the standard VU meter.

Note that the Loudness selection is not applicable for Dolby-E metering.

RALM – Meter Ballistics Config tab

Type – select a type of meter from the pull-down list.

The “Test” mark of the scale “Analog Peak Meter - EBU-PPM” and the “4” mark of the scale “Analog Peak Meter – UK PPM” correspond to -24 dBFS.

The “0” mark of the VU meter corresponds to -20 dBFS.

Upper Zone Limits – select the crossover level between the upper and middle zones of the meter (the

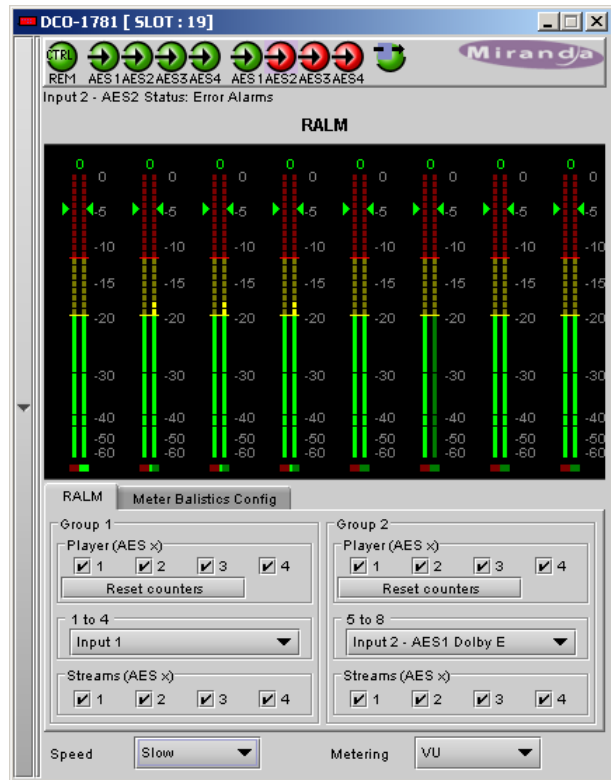

Figure 3.28 RALM panel



Figure 3.29 RALM - Meter Ballistics config.

range of values shown in the pull-down list depends on the meter type). The zone limits are in dBu for analog meters and in dBFS for digital meters

Lower Zone Limits – select the crossover level between the middle and lower zones of the meter (the range of values shown in the pull-down list depends on the meter type). The zone limits are in dBu for analog meters and in dBFS for digital meters

Color samples – the three samples show the currently-selected color for the upper, middle and lower zones of the meter.

Overload Counter - The overload cursor appears on the meter as an arrowhead in the meter scale. The two pull-down boxes set the position of the overload cursor on the left and right meters. If the audio level on that channel goes above the cursor, the Overload Counter at the top of the meter is incremented. The **Reset Counter** box is available on the **RALM** tab.

Phasemeter – this is a small meter that represents the phase correlation factor. Nominal position is in the center, which indicates also the absence of signal. The red side, up to the left end of the meter indicates the level of phase opposition and the green side, up to the right end indicates the level of phase amplitude.

3.4.9 The *Rear Type* panel

This panel identifies the type of rear currently installed for this card in the Densité frame.

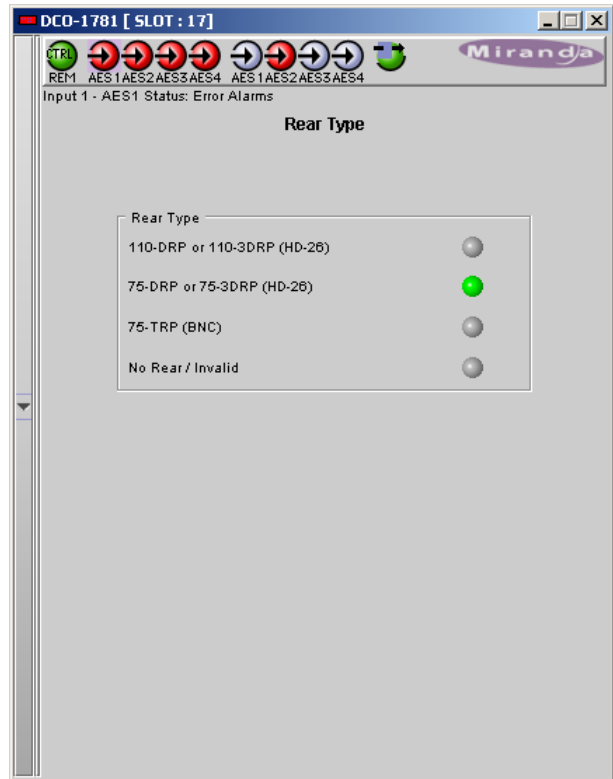

Figure 3-10 *Rear Type* panel

3.4.10 The *Factory / Presets* panel

This panel provides resources for saving, restoring and transferring the configuration settings of this DCO-17n1.

Factory Settings

The DCO-17n1 maintains a “Factory Default” alignment in its memory, to which it can be restored at any time.

- Click the *Load Factory* button to restore the card to its Factory default alignment.

User Presets

The User Preset controls allow the user to save and recover all configuration settings on the card.

Select any one of the five presets using the pulldown list. The name of the currently-selected User Preset is shown on the on the pulldown icon (e.g. *User1*, *User2*,... *User5*)

- Click *Load* to load the contents of the selected User Preset into the DCO-17n1. All parameter settings and values will be replaced by the contents of the selected User Preset.
- Click *Save* to store the current parameter settings and values from the DCO-17n1 into the selected User Preset. The existing contents of the preset will be overwritten.

Profiles

This section provides the option to save and recover the entire card configuration (including user presets if desired) on an external disk, or to copy it to another DCO-17n1 card.

Click on *Profiles* to open the Profile Copy window.

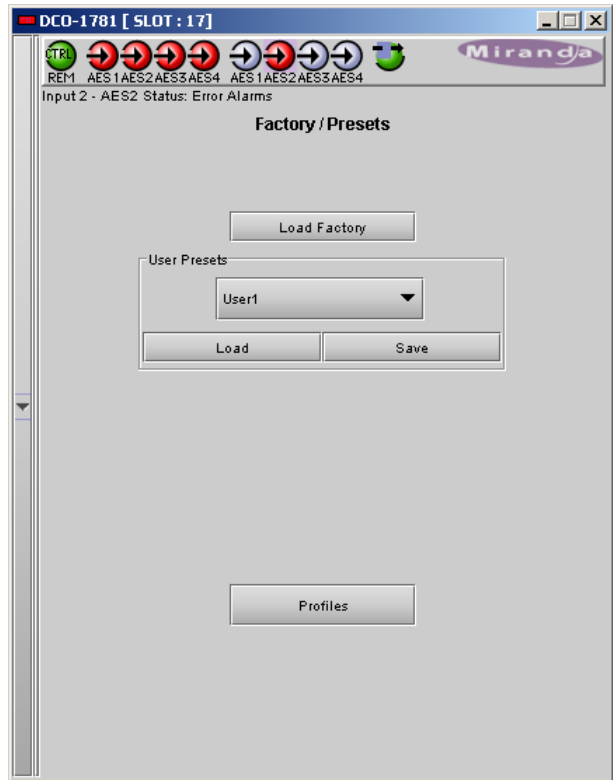

Figure 3.31 *Factory / Presets* panel

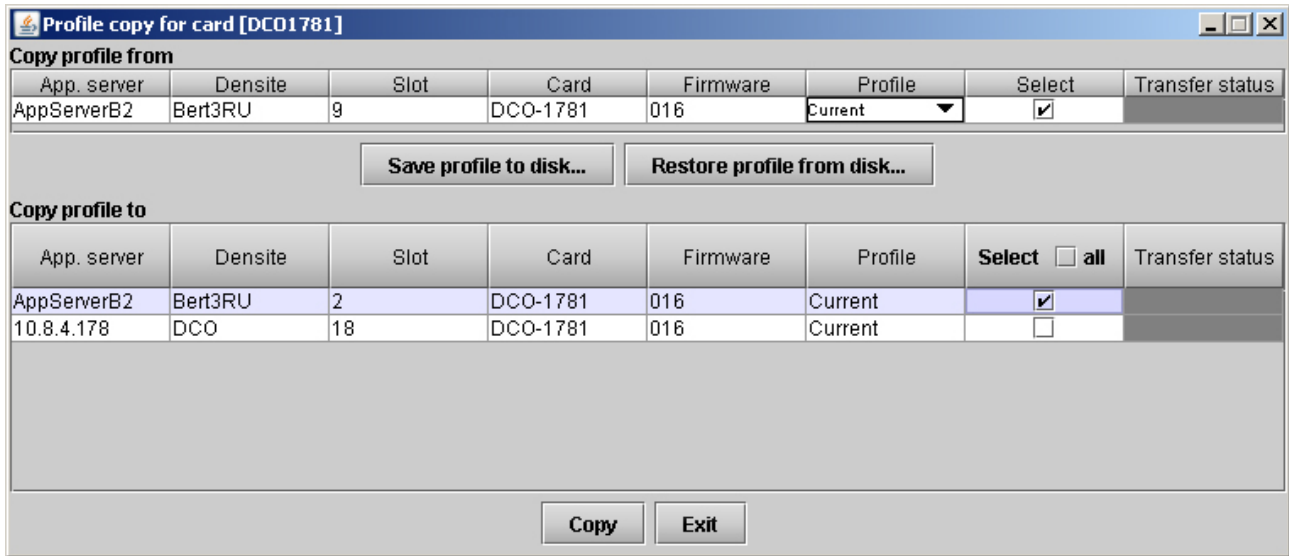

Figure 3.32 Profile Copy Window

Copy Profile From:

This line shows this DCO-17n1 card, and identifies it by App server, Densité frame and slot number, card type and firmware version.

The *Profile* column has a pulldown that allows you to select which profiles you will work with, and gives these choices:

- Current, User1, User2, User3, User4, User5

The *Select* column includes a checkbox, preselected as checked, to confirm that you want to work with the current card.

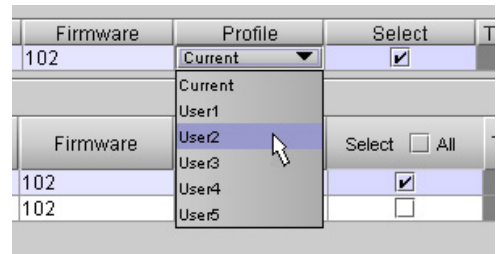

Figure 3.33 Select Profile to copy

Save Profile to Disk...

Click this button to open a Save dialog allowing you to specify a file name and location to which the selected profiles for this card will be saved.

Hint - It is a good idea to create a folder for these files, because they are not explicitly identified as DCO-17n1 profiles, and will be difficult to find and identify if not clearly named and conveniently located.

- Click the save button once the name and location have been identified in the Save box
- If the file is saved correctly, the Transfer Status box on the right of the *Copy profile from* line will indicate *Succeeded* against a green background
- If the file was not saved for some reason, the Transfer Status box to the right of the *Copy profile from* line will indicate *Failed* against a red background

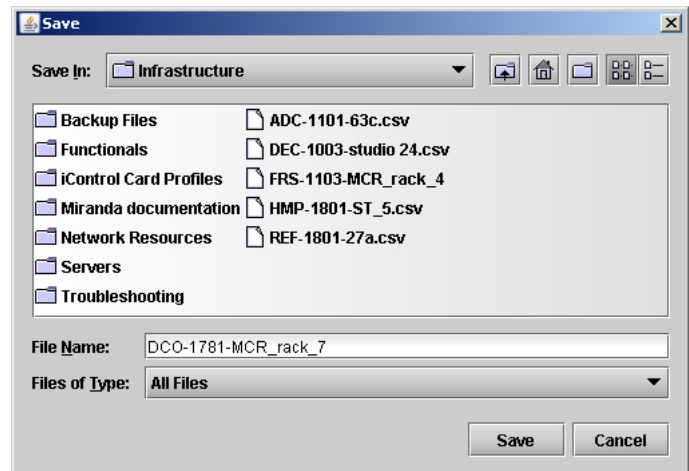

Figure 3.34 Save Profile to Disk window

Restore profile from disk...

Click this button to open an *Open* dialog box within which you can locate and select a valid DCO-17n1 profile file.

- Click Open to read the contents of the file and to reconfigure this DCO-17n1's profiles according to its contents
- While the reconfiguration is in progress, the Transfer Status box on the right of the *Copy profile from* line will indicate *Working* against a yellow background
- When the reconfiguration is complete, the Transfer Status box on the right of the *Copy profile from* line will indicate *Succeeded* against a green background

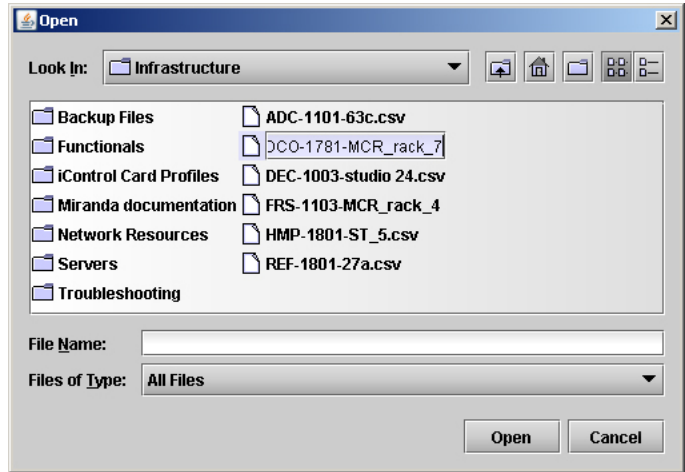

Figure 3.35 Open a profile file to restore profiles

Note: There is no need to select a profile using the Profile pulldown (e.g. Current, User1, etc.) when restoring a profile from disk. The profile selection is stored within the file.

Copy profile to section

This line shows other DCO-17n1 cards that are available on the iControl network, each identified by App server, Densité frame and slot number, card type and firmware version.

The *Profile* column shows the same information as is shown for the current card in the *Copy profile from* line, i.e.

- Current, User1, User2, User3, User4, User5

The *Select* column includes a checkbox to identify which DCO-17n1 cards you wish to copy profiles into from the current card.

- For convenience, a *Select all* checkbox is provided in the column header

Click *Copy* to copy the selected profiles from this card into the selected other DCO-17n1 cards

- While the profile copy operation is in progress, the Transfer Status box on the right of the *Copy profile to* line will indicate *Working* against a yellow background
- When the profile copy operation is complete, the Transfer Status box on the right of the *Copy profile to* line will indicate *Succeeded* against a green background

3.4.11 The *Options* panel

The Options panel describes the options available for the DCO-17n1. Each option is shown in its own tab. Miranda supplies an activation key when the option is purchased. Each option's tab includes a data entry box "Enter Key" where the activation key can be entered.

- Enter the Key in the data box, and click the *Enable Option* button to activate the feature.

Silent Switch option

The DCO-17n1 card allows switching as a regular router, or alternatively the module can perform an audio silent switch between sources using the "Silent Switch" option (software option). This option is named "DCO-17x1-OPT-SS".

About the Silent Switch Option

The Silent Switch Option (SSO) provides the possibility of a clean transition on the audio output, provided that the inputs are 48 kHz and properly timed.

- If a reference signal is present, it will be used only to generate test tones and apology signals. The SSO does not need a video-related reference signal.

During a switch, the SSO performs a fade out/fade in audio switch to prevent any pops or clicks.

- The switch will be free of any glitches, providing that the switch is not due to loss of input or to a detected format or reference mismatch.

The DCO-1781 automatically detects the format of an audio channel:

- If it detects that a channel is non-PCM, the switch will be a straight cut
- The transitions between two Dolby-E signals will be placed between the Dolby-E packets.
- The transitions between two AC-3 signals will be placed between the AC-3 packets.

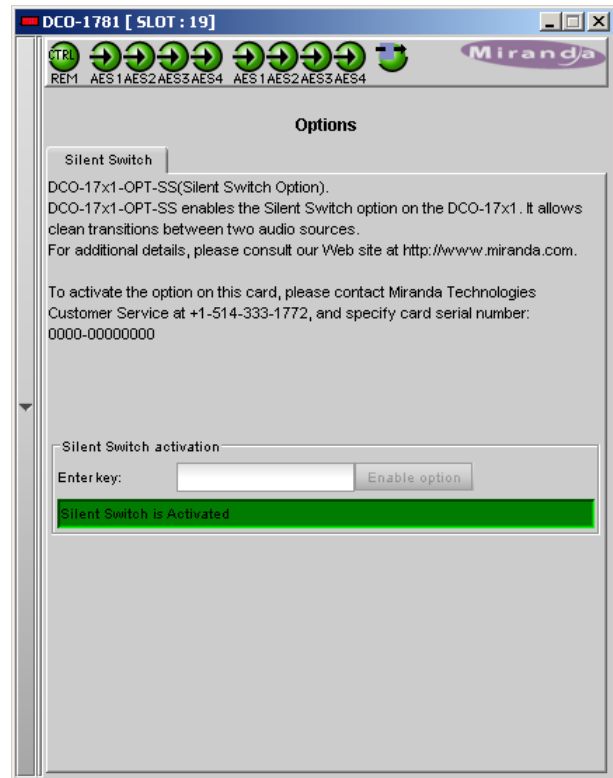

Figure 3.36 Options panel

3.4.12 The *Info* panel

When the DCO-17n1 is included in an iControl environment, certain information about the card should be available to the iControl system. The user can enter labels and comments that will make this card easy to identify in a complex setup. This information is entered via the Info control panel. This panel also shows other information about the card.

Label: enter a label to represent this DCO-17n1 when it appears in iControl applications.

Short Label type the short-form label that iControl uses in some cases (8 characters)

Source ID type a descriptive name for this DCO-17n1

Comments: type any desired text



Figure 3.37 Info panel

The remaining data boxes show manufacturing information about this card.

- **Details...:** Reports the Firmware version, service version, and panel version for this card

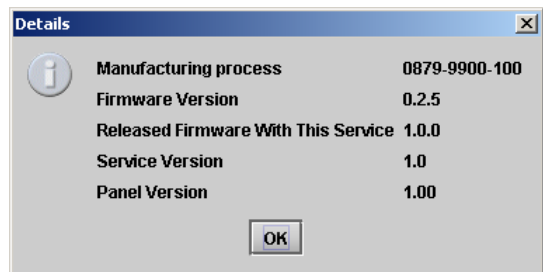

Figure 3.38 Details window

- **Advanced...:** Shows the Miranda LongID for this card. The Miranda LongID is the address of this DCO-17n1 in the iControl network.

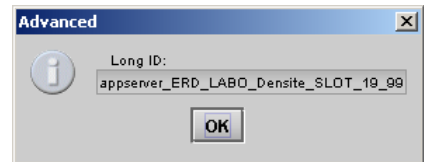

Figure 3.39 Advanced window

- Remote System Administration – opens the Joining Locators data box, which lists remote lookup services to which this DCO-17n1 is registered.

Add: Force the iControl service for this DCO-17n1 to register itself on a user-specified Jini lookup service, using the following syntax:

jini://<ip_address>

where <ip_address> is the ip address of the server running the lookup service

Remove: select one of the services listed in the window by clicking on it, and click *Remove* to delete it from the window.

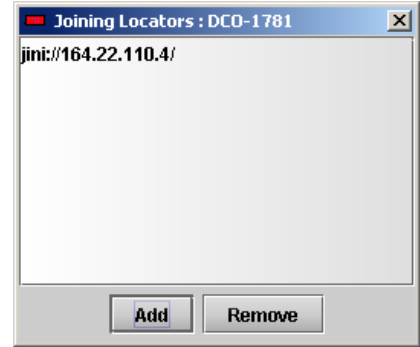

Figure 3.40 Joining Locators

3.4.13 The Alarm Config panel

This panel allows the alarm reporting of the DCO-17n1 to be configured. The panel opens in a new window when the button is clicked, and can be resized if needed.

The panel is organized in columns.

Status/Name

This contains an expandable tree listing all the alarms reported by this DCO-17n1 card.

- Each alarm name includes an icon that shows its current status
- Some alarms may be text-only and the alarm status is shown in the name and not by a status icon, e.g.

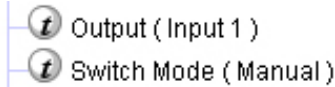

The **Overall alarm** and **GSM contribution** columns contain pulldown lists that allow the level of contribution of each individual alarm to the alarm named in the column heading to be set.

- If there is no arrowhead in the box, there is no pulldown and the alarm is not user-configurable

Overall Alarm

This column allows configuration of the contribution of each individual alarm to the Overall Alarm associated with this card. The Overall Alarm is shown in the upper left corner of the iControl panel, and also appears at the bottom of the Status/Name column.

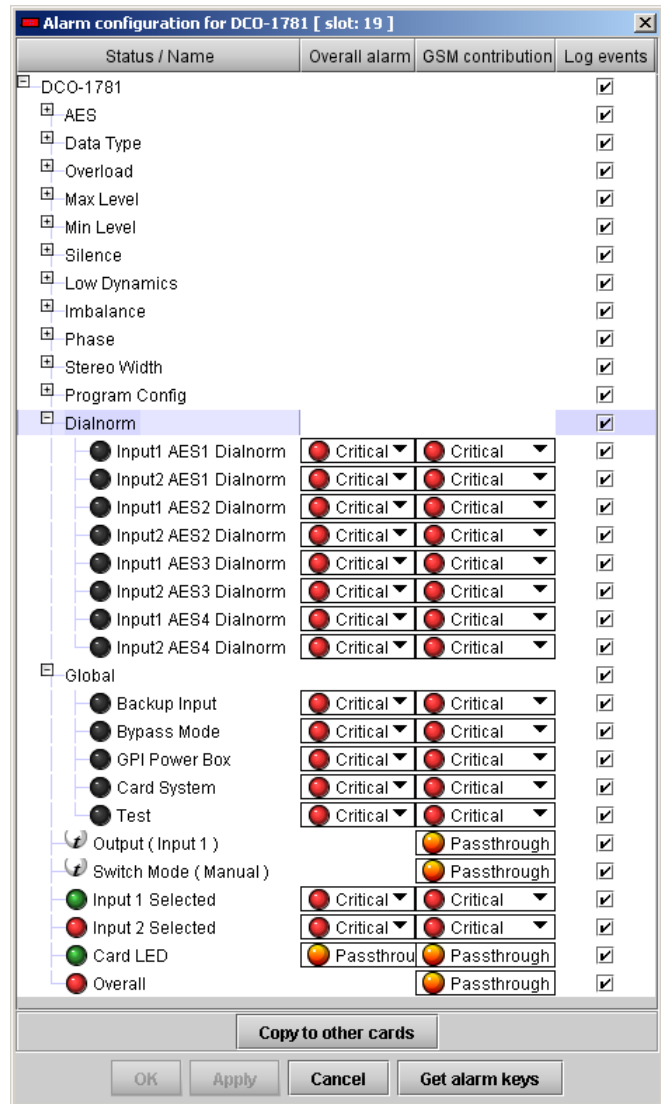

Figure 3.41 Alarm Config window

GSM Contribution

This column allows configuration of the contribution of each individual alarm to the GSM Alarm Status associated with this card. GSM is a dynamic register of all iControl system alarms, and is also an alarm provider for external applications. The possible values for this contribution are related to the Overall alarm contribution:

- If the Overall alarm contribution is selected as Disabled, the GSM alarm contribution can be set to any available value
- If the Overall alarm contribution is selected as any level other than disabled, the GSM contribution is forced to follow the Overall Alarm.

Levels associated with these alarms:

The pulldown lists may contain some or all of the following options:

- Disabled ▼ The alarm makes no contribution (black icon)
- Minor ▼ The alarm is of minor importance (yellow icon)
- Major ▼ The alarm is of major importance (orange icon)
- Critical ▼ The alarm is of critical importance (red icon)
- Passthrough ▼ The alarm exists but has no effect (used for text and composite alarms)

Shortcut: if you click in one of the columns beside a major heading in the Status/Name column (where there is no pulldown shown), you will open an “invisible” pulldown that lets you assign a level to all alarms in that section of the column simultaneously.

Log Events

iControl maintains a log of alarm events associated with the card. The log is useful for troubleshooting and identifying event sequences. Click in the checkbox to enable logging of alarm events for each individual alarm.

At the bottom of the window are several other controls:

Copy to other cards

Click this button to open a panel that allows the alarm configuration set for this card to be copied into another DCO-17n1 card.

- Select one or more destination cards from the list in the window by clicking in the checkboxes, or all of them by clicking in the All checkbox
- Note that when you do a Copy Profile for this card (see Sect.3.4.10), the alarm configuration is copied along with all the other settings.

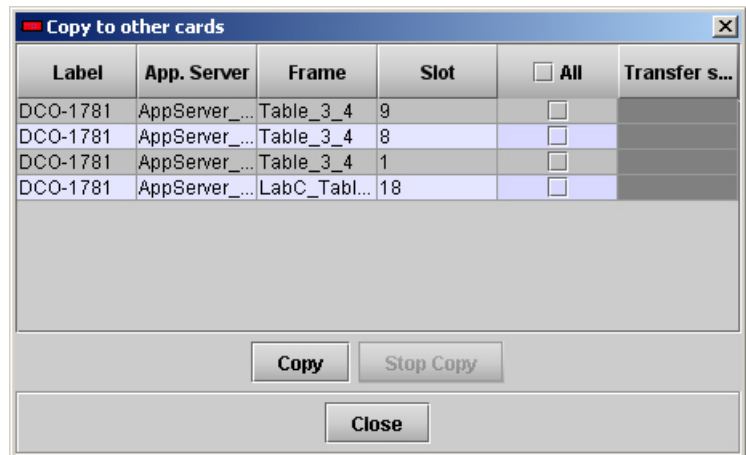

Figure 3.42 Copy to other cards

Get alarm keys

Click this button to open a save dialog where you can save a file containing a list of all alarms on this card and their current values, along with an Alarm Key for each. The alarm keys are useful for system integration and troubleshooting.

- The file is saved in Excel.csv format

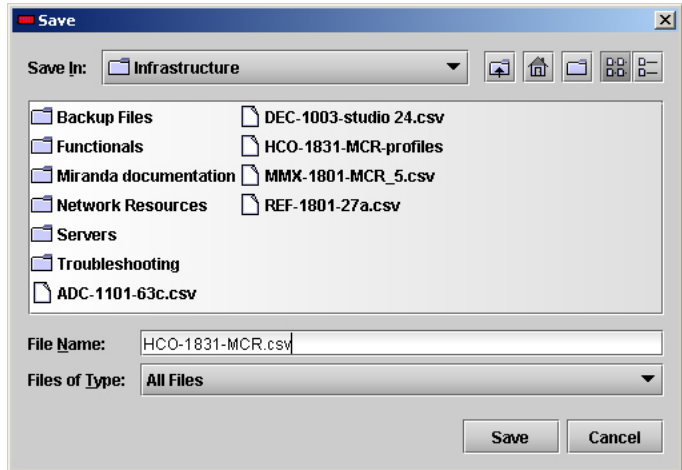

Figure 3.43 Get alarm keys save dialogue

OK, Apply, Cancel

- **OK** accepts the settings and closes the window.
- **Apply** accepts the settings, but leaves the window open.
- **Cancel** closes the window without applying any changes, and leaves the previous settings intact.

4 Specifications

ACTIVE MODE

DIGITAL INPUTS

AES-3:

Level:	0.3 to 7.0 Vpp
Impedance:	110 Ω balanced
Common mode:	7 V peak DC to 20 kHz (transformer inputs)
Equalization:	>250 m (800') with DRAKA Ref. KFB AUDIO PBG 110 >100 m (300') with Belden 1800B
Jitter tolerance:	AES3 jitter template is respected

AES-3id:

Level:	0.3 to 2 Vpp
Impedance:	75 Ω
Equalization:	450 m (150 m cable clone + 300 m Belden 8281)
Return loss:	-21 dB @ 12.288 MHz
Jitter tolerance:	AES3 jitter template is respected

DIGITAL OUTPUTS

AES3:

Level:	3.8 Vp-p nominal
Impedance:	110 Ω balanced
Rise time:	13 ns
Fall time:	13 ns
Overshoot:	0%

AES-3id:

Level:	1.0 Vpp
Overshoot:	0%
Rise time:	32 ns
Fall time:	28 ns
Impedance:	75 Ω
Return loss:	-18 dB @ 6.144 MHz

Processing:

Sampling Frequency	48 kHz only
Tone generator	1 kHz sine wave interrupted on left channel (250 ms / 3 s) EBU R49.
Latency delay:	62.5 μ s (3 samples) with Silent Switch option.

PASSIVE MODE

AES-3id:

Return loss:	-23 dB @ 12.288 MHz with DCO-17n1 -29 dB @ 12.288 MHz with Rear Panel only
--------------	---

Processing:

Sampling Frequency	32 to 96 kHz only
Latency delay:	0 samples.

MISCELLANEOUS**GPI inputs**

Auto, Byp, 1, 2
Power input

opto-isolated, contact closure to ground, trigger for 40 ms minimum.
external +5 V DC +10/-20 %, 70 mA for the latching relays activation.

GPI outputs

Auto
Byp, 1, 2

75 mA, 30 V max
150 mA, 28 V max

Silent Switch option

(inputs must be synchronous)

PCM
AC-3
Dolby-E

Fade in/out 10 ms, no AES error
no AC-3 error, no AES error
no Dolby error, no AES error

POWER:

DCO-17n1-75-DRP

Active Mode (Manual/Auto)
Passive Mode

2.5 W nom. (104 mA), 2.7 W max. (112 mA)
1.6 W nom. (67 mA), 1.8 W max. (75 mA)

DCO-17n1-110-DRP

Active Mode (Manual/Auto)
Passive Mode

3.4 W nom. (139 mA), 3.7 W max. (151 mA)
1.9 W nom. (77 mA), 2.2 W max. (89 mA)

ANNEX – Local Control Panel User Interface

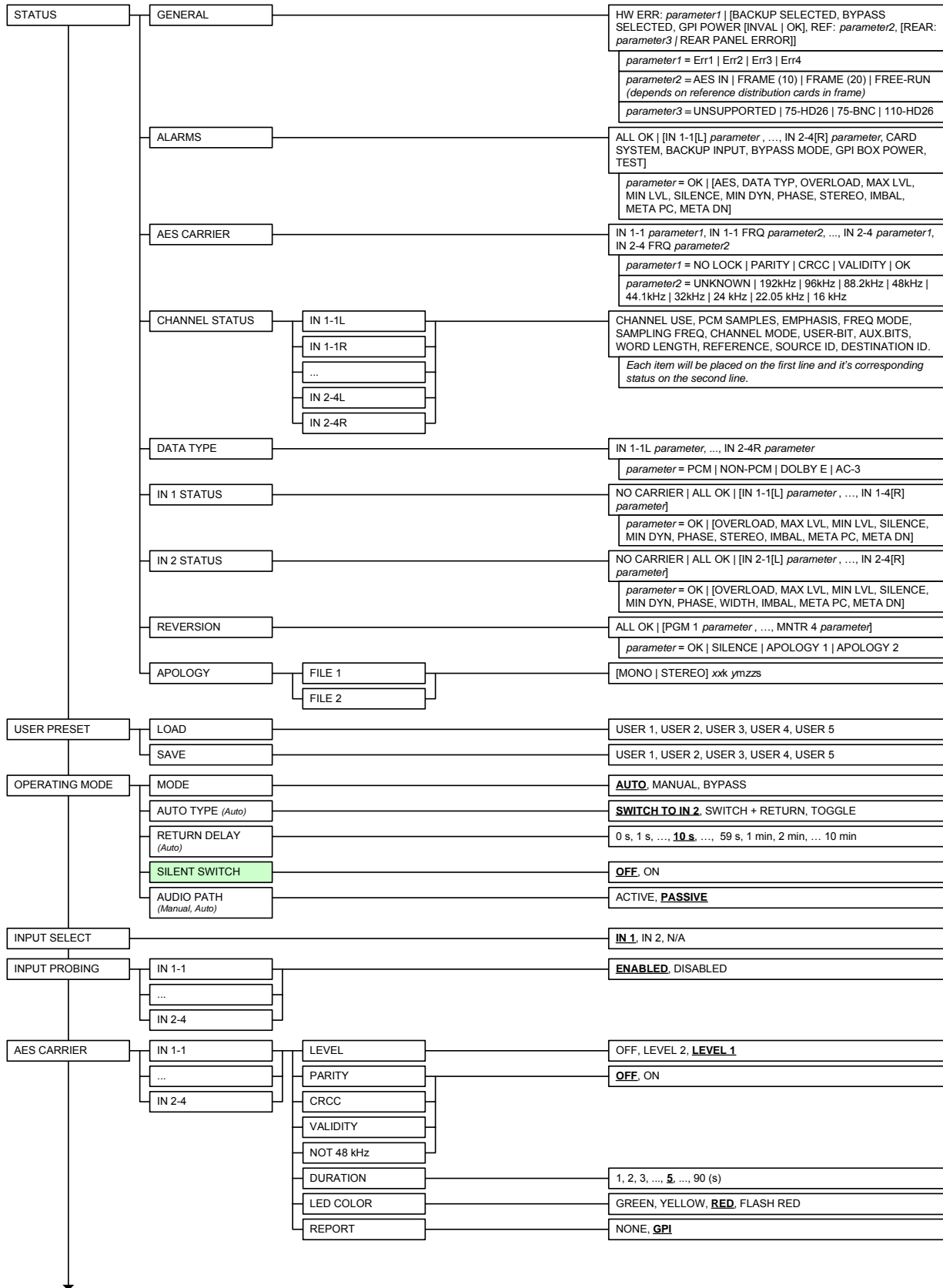

GUIDE TO INSTALLATION AND OPERATION

