

DENSITÉ series

LNS-3901 **3Gbps/HD/SD Line Synchronizer** Guide to Installation and Operation

M932-9400-112

24 December 2014



3499 Douglas-B.-Floreni
St-Laurent, Québec, Canada H4S 2C6

Tel. 514-333-1772
Fax. 514-333-9828
www.grassvalley.com

© 2014 Grass Valley A Belden Brand

Electromagnetic Compatibility



This equipment has been tested for verification of compliance with FCC Part 15, Subpart B requirements for Class A digital devices.

NOTE: This equipment has been tested and found to comply with the limits for a Class A digital device, pursuant to part 15 of the FCC Rules. These limits are designed to provide reasonable protection against harmful interference when the equipment is operated in a commercial environment. This equipment generates, uses, and can radiate radio frequency energy and, if not installed and used in accordance with the instruction manual, may cause harmful interference to radio communications. Operation of this equipment in a residential area is likely to cause harmful interference in which case the user will be required to correct the interference at his own expense.



This equipment has been tested and found to comply with the requirements of the EMC directive 2004/108/CE:

- EN 55022 Class A radiated and conducted emissions
- EN 55024 Immunity of Information Technology Equipment
- EN 61000-3-2 Harmonic current injection
- EN 61000-3-3 Limitation of voltage changes, voltage fluctuations and flicker
- EN 61000-4-2 Electrostatic discharge immunity
- EN 61000-4-3 Radiated electromagnetic field immunity – radio frequencies
- EN 61000-4-4 Electrical fast transient immunity
- EN 61000-4-5 Surge immunity
- EN 61000-4-11 Voltage dips, short interruptions and voltage variations immunity

Table of Contents

1	LNS-3901 3Gbps/HD/SD Line Synchronizer	1
1.1	Introduction	1
1.2	Features	1
1.3	Functional Block Diagram	1
1.4	Front Card-edge Interface.....	2
2	Installation.....	3
2.1	Unpacking	3
2.2	Installation in the Densité frame.....	3
2.3	Rear Panels and Connectors.....	3
3	User Interface	5
3.1	Control options	5
3.2	Card-Edge Status LED	5
4	Local control using the Densité frame control panel	6
4.1	Overview	6
4.2	Menu for local control.....	6
5	Remote control using iControl.....	7
5.1	The iControl graphic interface window.....	7
5.2	Video Input / Output panel	9
5.2.1	Line synchronizer operation.....	10
5.2.2	Operational Setup	10
5.3	Reference panel.....	12
5.4	Factory / Presets panel	13
5.5	Alarm Config panel	13
5.6	Info panel	16
6	Specifications.....	18
7	Grass Valley Technical Support.....	19
	ANNEX 1 – LNS-3901 Local User Interface	20
	ANNEX 2 – Updating the LNS-3901	21

1 LNS-3901 3Gbps/HD/SD Line Synchronizer

1.1 Introduction

The LNS-3901 is a 3G/HD/SD line synchronizer capable of handling hot switches between sources of the same format and phased by less than 10 lines compared to the reference. The output timing will be programmed from $\frac{1}{2}$ to $10 \frac{1}{2}$ lines after the 0H of the reference. The reference signal is an analog black burst reference, tri-level sync, or the internal URS frame reference signal.

The LNS-3901 is a very high density card. Up to 20 cards can fit in a Densité 3 frame. It is also a low cost solution to synchronize video signals at the output of a router and prevent downstream video glitches. Using the appropriate rear module, a bypass relay is available to automatically bypass the card's processing when the card loses power or if it is removed from the frame.

All card parameters and statuses can be controlled or monitored through iControl.

1.2 Features

- 3Gbps/HD/SD input
- Supports 3Gbps level A and level B (dual link)
- Automatic detection of video input format.
- Flexible external reference or internal URS frame reference input
- Clean output on video input "hot switches" within a 10-line window.
- Output timing can be adjusted from $\frac{1}{2}$ to $10 \frac{1}{2}$ lines after reference.
- Automatic pass-through of all ancillary data, VBI and embedded audio.
- Removes high and low frequency jitter out of the video signal
- Bypass relay on the -R rear module

1.3 Functional Block Diagram

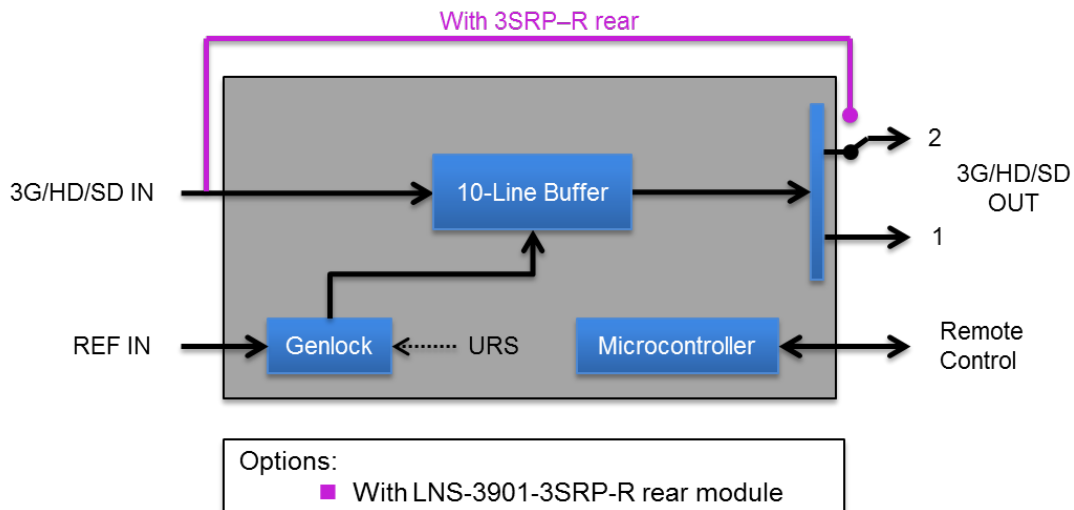

Figure 1.1 LNS-3901 Functional Block Diagram

1.4 Front Card-edge Interface

The front card-edge of the LNS-3901 incorporates two elements:

- Status LED (see section 3.2)
- Select Button (see section 4)

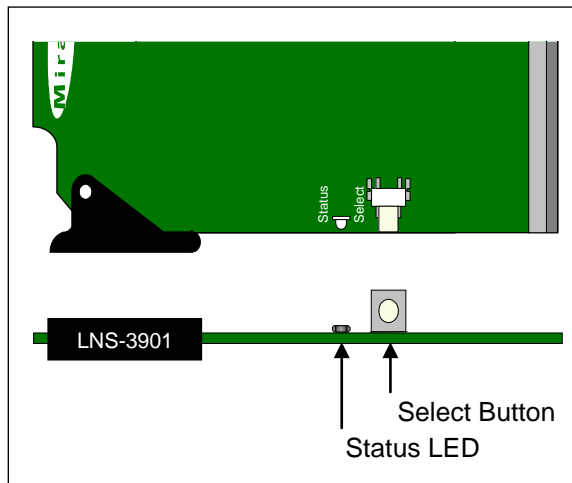

Figure 1.2 Front card-edge layout

2 Installation

2.1 Unpacking

Make sure the following items have been shipped with your LNS-3901. If any of the following items are missing, contact your distributor or Miranda Technologies Inc.

- LNS-3901 3G/HD/SD Line Synchronizer
- A rear panel. (see Section 2.3 below for details)

2.2 Installation in the Densité frame

The LNS-3901 and its associated rear connector rear panel must be mounted in a DENSITÉ 3 RU frame. It is not necessary to switch off the frame's power when installing or removing the card. See the DENSITÉ Frame manual for detailed instructions for installing cards and their associated rear panels.

2.3 Rear Panels and Connectors

Two different rear panels are available for the LNS-3901:

- LNS-3901-3SRP Rear panel
- LNS-3901-3SRP-R Rear panel with integral bypass relay

These rear panels are shown in the figure below, and their various inputs and outputs are described.

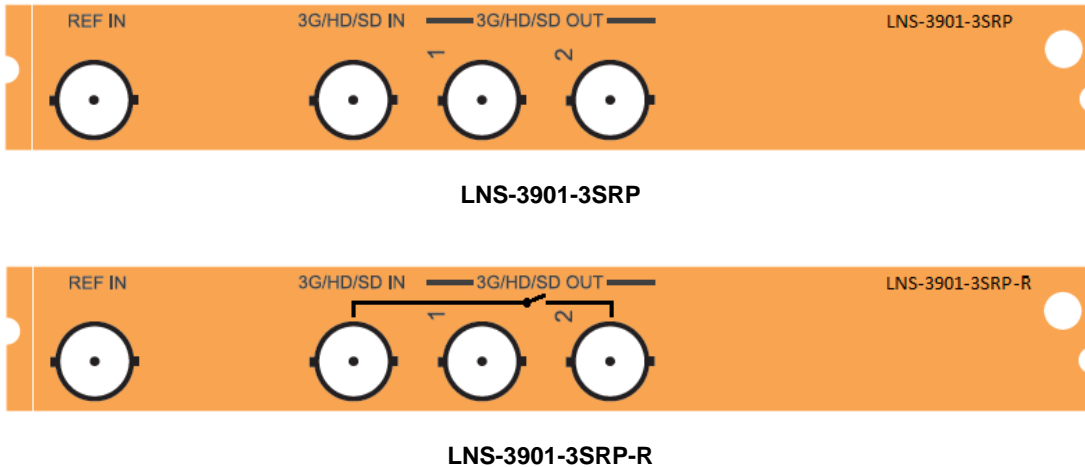

REF IN – Studio reference input

For external synchronization, connect a black studio reference signal to the BNC labeled **REF IN**.

The reference input must conform to SMPTE 170M/SMPTE 318M/ITU 624-4/BUT 470-6 for standard definition signals and SMPTE 274M / SMPTE 296M for high definition signals and is used to phase the HD/SD SDI outputs to

the studio. A reference mismatch error will occur if there is a difference between the input video format's frame rate and the reference format's frame rate. When a reference mismatch occurs, the LNS-3901 output will be undefined and unstable. The error will be reported by the card-edge status LED (see section 3.2) and by the [Input Status Icon](#) in the iControl panel (see section 5.1).

Note that in the case of HD signals of the same frame rate, any reference signal may be used to genlock any output signal, regardless of scan type (progressive or interlaced). When a 720p/tri-level sync reference signal is used with an interlaced output, the output is synchronized but there may be a delay of one field depending on when the synchronization started.

In the case of HD 1080p23 and 1080p23SF input signals, it is recommended to use a REF-1801 card connected to a black burst analog reference that has SMPTE 318M signaling. The card must be configured to use the intra frame URS signal. This is the only way to ensure proper output alignment and clean switch.

3G/HD/SD IN – Serial digital 3G/HD/SD input

Connect a serial digital video signal, conforming to the SMPTE 425M standard for 3G input signals, SMPTE 292M standard for HD input signals or SMPTE 259M standard for SD input signals, to the BNC labeled **3G/HD/SD IN**. The LNS-3901 will automatically switch to the detected line/frame rate format.

- NOTE - The input signal must be locked to the reference in use (either the external reference or the URS)

3G/HD/SD OUT – Serial digital video outputs

The LNS-3901 provides two 3G/HD/SD SDI video outputs on BNC connectors, labeled **3G/HD/SD OUT 1** and **2**. The SDI video signal conforms to the SMPTE 425M, SMPTE 292M or SMPTE 259M-C standard. The same signal is carried on all outputs.

- NOTE – When the bypass relay on the LNS-3901-3SRP-R rear panel is activated, output 2 is connected directly to the 3G.HD/SD IN input connector, bypassing the card.

3 User Interface

3.1 Control options

The LNS-3901 can be controlled in two different ways:

- The local control panel and its push-buttons can be used to move through a menu of parameters and to adjust parameter values (see section 4).
- Miranda’s iControl system can be used to access the card’s operating parameters from a remote computer, using a convenient graphical user interface (GUI) (see section 5).

3.2 Card-Edge Status LED

The status monitor LED is located on the front card-edge of the LNS-3901, and is visible through the front access door of the DENSITÉ frame. This multi-color LED indicates the status of the LNS-3901 by color, and by flashing/steady illumination.

The chart shows how the various error conditions that can be flagged on the LNS-3901 affect the LED status.

- If a cell is gray, the error condition cannot cause the LED to assume that status.
- If more than one LED status is possible for a particular error condition, the status is configurable. See Section 5.16 for details.
- The factory default status is shown by a ⚙️

The LED will always show the most severe detected error status that it is configured to display, and in the chart error severity increases from left to right, with green representing no error/disabled, and flashing red the most severe error.

If the LED is Flashing Yellow, it means that the card is selected for local control using the Densité frame’s control panel. See Section 4 for details.

Error Condition	LED Status			
	Green	Yellow	Red	Flashing Red
Cooling Fan 1 error				⚙️
FPGA error				⚙️
Dataflash Error				⚙️
No Rear				⚙️
Reference missing			⚙️	
Reference mismatch			⚙️	
Carrier 1 detect error			⚙️	
Input timing outside range			⚙️	

4 Local control using the Densité frame control panel

4.1 Overview

Push the SELECT button on the LNS-3901 card edge (see Section 1.4) to assign the local control panel to operate the LNS-3901. Use the control panel buttons to navigate through the menu, as described below.

All of the cards installed in a Densité frame are connected to the frame's controller card, which handles all interaction between the cards and the outside world. There are no operating controls located on the cards themselves. The controller supports remote operation via its Ethernet ports, and local operation using its integrated control panel.

The local control panel is fastened to the front of the CPU-ETH2 controller card, and when installed can be accessed by opening the front door of the frame. The panel consists of a display unit capable of displaying two lines of text, each 16 characters in length, and five pushbuttons.

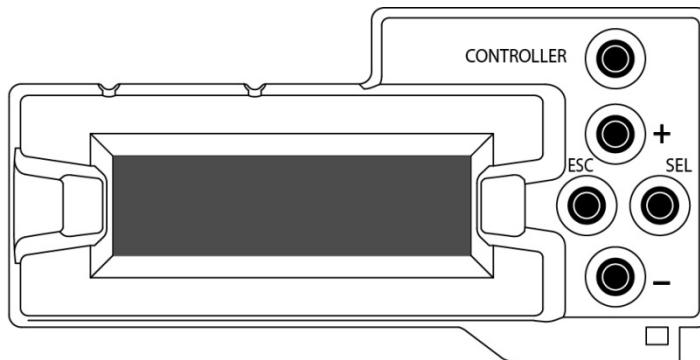

Figure 4-1 Densité Frame local control panel

The panel is assigned to operate any card in the frame by pushing the SELECT button on the front edge of that card.

- Pushing the CONTROLLER button on the control panel selects the Controller card itself.
- The STATUS LED on the selected card flashes yellow.

The local control panel displays a menu that can be navigated using the four pushbuttons located beside the display. The functionality of the pushbuttons is as follows:

[+] [-] Used for menu navigation and value modification

[SELECT] Gives access to the next menu level. When a parameter value is shown, pushing this button once enables modification of the value using the [+] and [-] buttons; a second push confirms the new value

[ESC] Cancels the effect of parameter value changes that have not been confirmed; pushing [ESC] causes the parameter to revert to its former value.

Pushing [ESC] moves the user back up to the previous menu level. At the main menu, [ESC] does *not* exit the menu system. To exit, re-push the [SELECT] button for the card being controlled.

If no controls are operated for 30 seconds, the controller reverts to its normal standby status, and the selected card's STATUS LED reverts to its normal operating mode.

4.2 Menu for local control

The LNS-3901 has operating parameters which may be adjusted locally at the controller card interface.

- Press the SELECT button on the LNS-3901 front card edge to assign the Densité frame's local control panel to the LNS-3901
- Use the keys on the local control panel to step through the displayed menu to configure and adjust the LNS-3901.

The complete menu structure is shown in Annex 1 to this document, beginning on page 20.

5 Remote control using iControl

The operation of the LNS-3901 may be controlled using Miranda's iControl system.

- This manual describes the control panels associated with the LNS-3901 and their use.
- Please consult the iControl User's Guide for information about setting up and operating iControl.

In iControl Navigator or iControl Websites, double-click on the LNS-3901 icon to open the control panel.

5.1 The iControl graphic interface window

The basic window structure for the LNS-3901 is shown in figure 5.1. The window identification line gives the card type (*LNS-3901*) and the slot number where the card is installed in its Densité frame.

There are three main sections in the window itself, identified in figure 5.1:

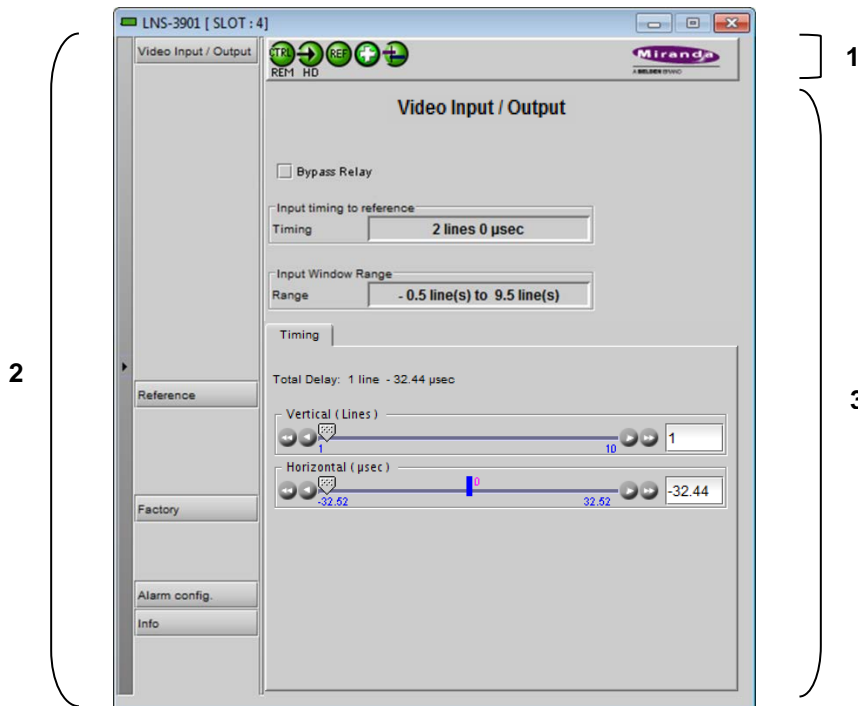

Figure 5-1 LNS-3901 iControl graphic interface window

Section 1. The top section displays five icons on the left. These icons report different statuses such as card communication status, input signal and reference signal format and statuses. In some instances, they relate to conditions defined through parameters settings.











Icon # 1 2 3 4 5



Move the mouse over an icon and a status message appears below the icon providing additional information. If there is an error, the error status message appears in the message area without mouse-over.

- If there are multiple errors, the error messages cycle so all can be seen
- The icon whose status or error message is shown is highlighted with a mauve background

The table below describes the various status icons that can appear, and how they are to be interpreted.

- In cases where there is more than one possible interpretation, read the error message in the iControl window to see which applies.

Icon #1 – Manual Card Configuration	
	Remote card control activated. The iControl interface can be used to operate the card
	Local card control active, The card is being controlled using the Densité frame control panel, as described in section 4. Any changes made using the iControl interface will have no effect on the card.
Icon #2 – Input status	
	Signal detected and valid. <ul style="list-style-type: none"> • Beneath the icon, the format will be indicated as 3G, HD or SD, and the specific format details will be listed if the cursor is moved over the icon.
	Signal absent No rear Reference mismatch Video/TRS error
Icon #3 – Reference	
	Reference OK. Mouse over to see the source of the reference, and its format, e.g. External, NTSC
	Reference missing. The reference is required for correct line synchronizer operation.
	Reference absent
Icon #4 – Hardware Health	
	Hardware OK
	Hardware Health Monitoring (Fan1, Fan2, Hardware fault detected) If this icon appears red, return the card to Miranda and specify the error code.

Icon #5 – Input Window	
 (green)	Input timing within range
 (red)	Input timing outside range

Section 2. The left portion of the window contains all the parameter groups, which become highlighted when they are selected; the main panel (3) then displays the group’s set of parameters. Each of the groups is described in detail below.

Section 3. The main panel contains all the parameters specific to the group selected. It may contain several tabs to help manage the different parameters.

Each of the panels associated with the groups accessed from the buttons in Section 2, and shown in Section 3, is described individually in the following sections.

5.2 Video Input / Output panel

This panel monitors the status of the input timing compared to the reference, and sets up the synchronizer timing.

Bypass Relay: select the checkbox to activate the bypass relay in the LNS-3901-3SRP-R rear panel

- This connects the rear panel input directly to the output, bypassing the card.
- The checkbox will not appear if a rear panel with no bypass relay is installed.

Input timing to reference: the databox shows the measured horizontal timing of the current input signal compared to the selected timing reference for the LNS-3901.

Input window range: the databox shows the positioning of the 10-line window with respect to the selected reference for the LNS-3901. This is adjusted using the *Input Window* slider below.

Timing

The *Total Delay* shows the current output timing with respect to the timing reference selected for the LNS-3901 card. This is the sum of the timing adjustments selected using the two sliders.

Vertical (lines): sets the offset of the 10-line input window with respect to the reference over the range 1 to 10 lines.

Horizontal (µsec): sets the fine timing at the LNS-3901 output.

See the following description for an explanation of the functionality of these adjustments.

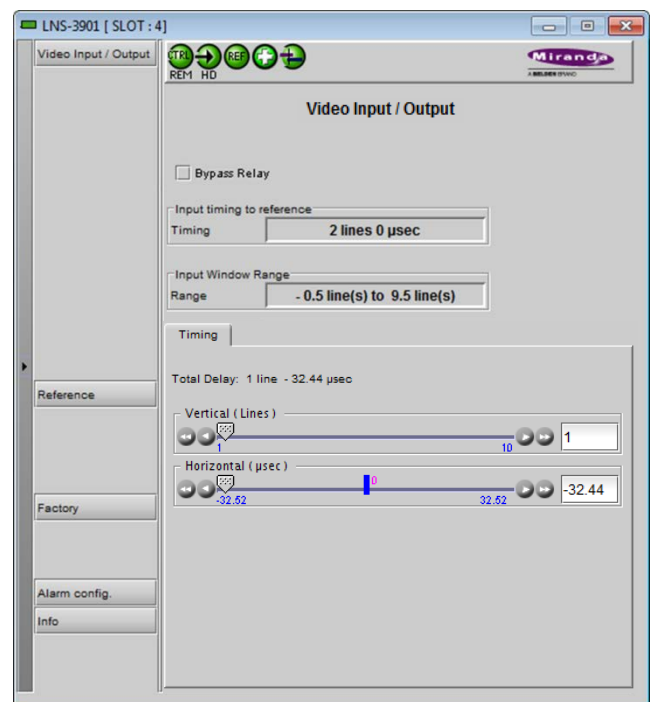

Figure 5-2 Video Input / Output panel

5.2.1 Line synchronizer operation

The Line synchronizer in the LNS-3901 can conceal a hot-switch occurring in the input signal without producing artifacts on the output, under specific conditions.

- In order to enable the line synchronizer, a valid external reference signal must be installed or the URS signal must be selected as the reference in the Reference panel (see section 5.3).
- If the reference is missing when the line synchronizer is activated, the Input timing to reference box will indicate “Missing reference” in red, and the reference status icon at the top of the iControl window will turn red and show the message “Reference missing”.

For the line synchronizer to function correctly, the following requirements must be met:

- All input signals must be synchronized to the reference.
- The signals on both sides of a hot switch must fall within a ten-line window that also contains the reference.

If the two signals are more than 10 lines apart, the output will be glitchless, but the output image content will be shifted up or down by 10-plus lines.

When a reference is present, the LNS-3901 reports the difference in timing between the input and the reference in the *Input timing to reference* window, expressed in lines plus microseconds.

- If the signal is inside the 10-line input window, the timing will be shown in black
- If the signal is outside the 10-line input window, the timing will be shown in red

In order to provide maximum flexibility in configuring the LNS-3901, the position of the input window with respect to the reference is user-adjustable. The effect is to adjust the overall delay between the input reference and the output, in one line increments. This is accomplished using the *Vertical (lines)* slider, over a range of 1 to 10 lines. The actual position of the window is offset from the reference by $\frac{1}{2}$ H, and is shown in the *Input Window Range* databox.

A further $\pm \frac{1}{2}$ line fine adjustment of the output timing is provided by the *Horizontal (μ sec)* slider

5.2.2 Operational Setup

In operation, the objective is to set up the line synchronizer timing so that all possible inputs that might undergo a hot switch fall within the input window, while keeping the overall delay as low as possible.

Select each input signal in sequence, and adjust the *Vertical* slider to the lowest value that shows all of their timing values in the *Timing* databox above in black.

Note that signals falling into the very upper edge of the 10-line window cannot be compensated directly if they fall within the processing delay of the LNS-3901, so another full line of delay must be added.

The diagram on the next page (Figure 5.3) illustrates the various possible set-ups of the LNS-3901, based on the *Vertical* slider setting:

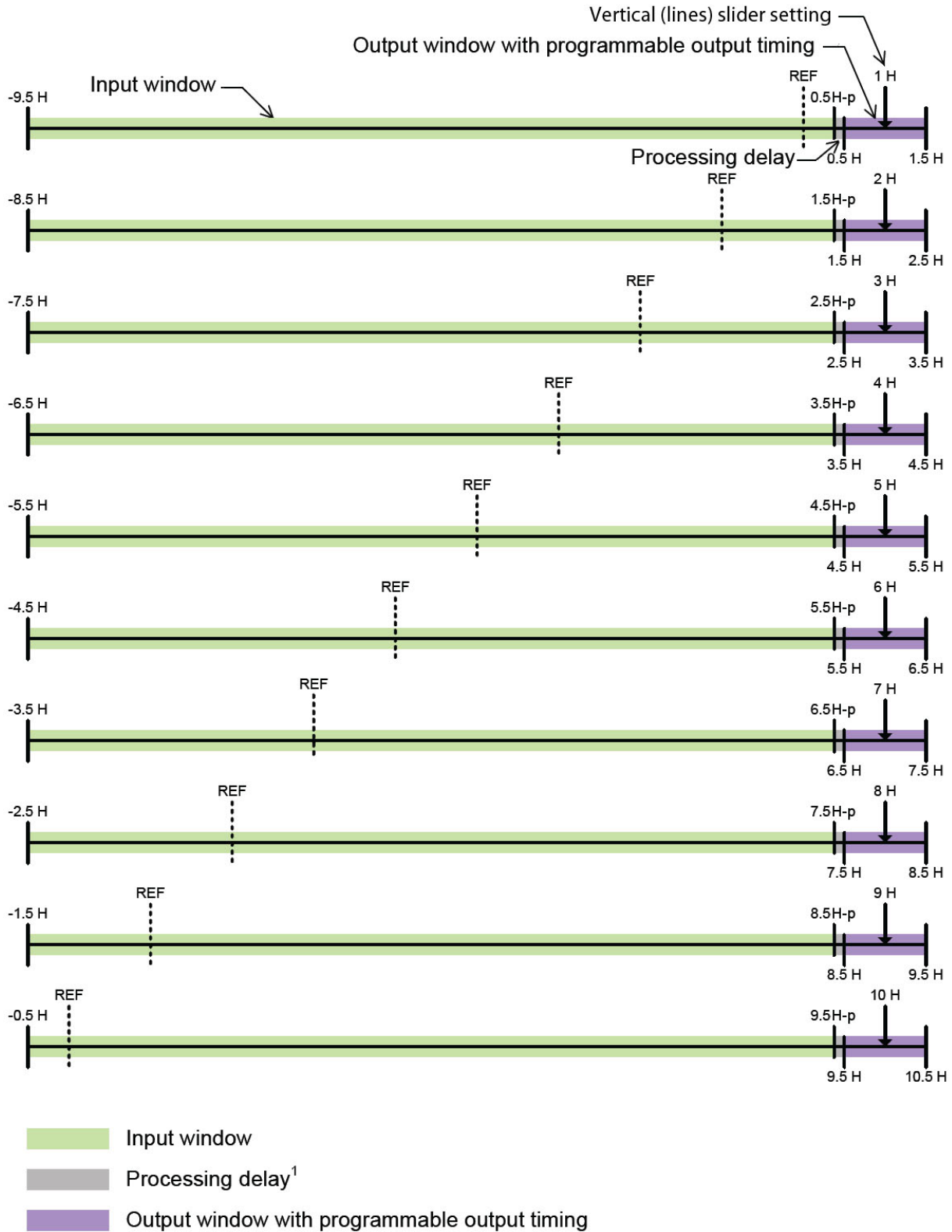

Note 1 :
For SD, HD, 3G-LA and 3G-LB SDI modes, the processing delay (p) is less than 200 pixels.

Figure 5-3 LNS-3901 timing

5.3 Reference panel

This panel allows the selection of the reference to be used by the LNS-3901. **Icons in the Reference Presence area indicate which references are available to this LNS-3901.**

Use the radio buttons in the Reference Source area to select from the following options:

- Auto – this mode selects the first source detected in this order of priority:
 - External reference from the rear panel REF IN
 - URS
 - Selected Input signal
- URS (Universal Reference Signal) – selects the internal reference from the backplane
- Input – uses the currently-selected input signal. **Note that, in this case, the LNS-3901 cannot provide glitch-free hot switch correction, because the reference timing changes with the input.**

URS Format – use the radio buttons in the URS Format area to select whether the URS is OFF, 29.97 Hz or 25 Hz.

- When URS is OFF, the URS reference format source cannot be selected, and will also be ignored by the automatic detection mode.

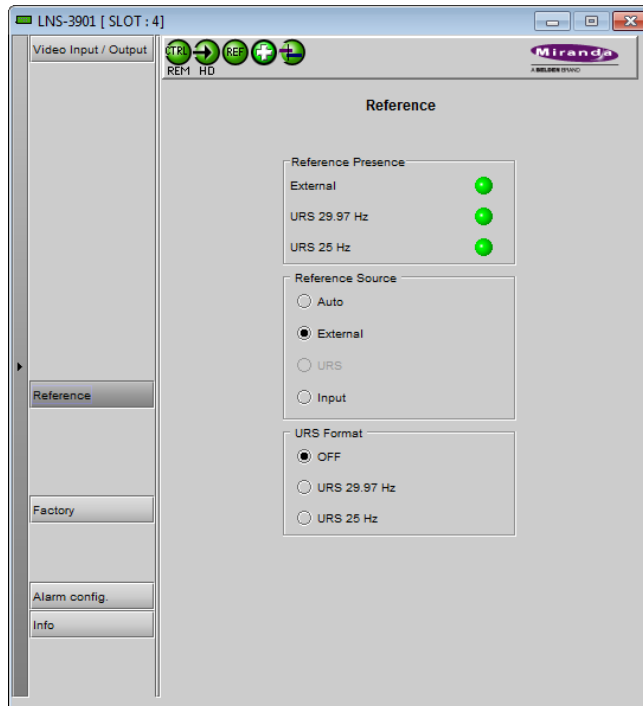

Figure 5-4 Reference panel

Note: Make sure the input signal is, at all times, locked to the selected reference signal.

The table shows which reference formats are suitable for all possible input video formats.

		Reference							
		NTSC	1080i59	720p59	URS-29	PAL	1080i50	720p50	URS-25
Video Formats	NTSC	X	X	X	X				
	720p59	X	X	X	X				
	1080i59	X	X	X	X				
	1080p23sf	X	X	X	X				
	1080p23	X	X	X	X				
	1080p29	X	X		X				
	1080p59 Level A	X	X	X	X				
	1080p59 Level B	X	X	X	X				
	PAL					X	X	X	X
	720p50					X	X	X	X
	1080i50					X	X	X	X
	1080p25					X	X		X
	1080p50 Level A					X	X	X	X
	1080p50 Level B					X	X	X	X

5.4 Factory / Presets panel

Load Factory: Clicking this button will restore the card to a factory default state. Two checkboxes enable the user to choose whether to include Parameters and/or Alarms in the restoration process

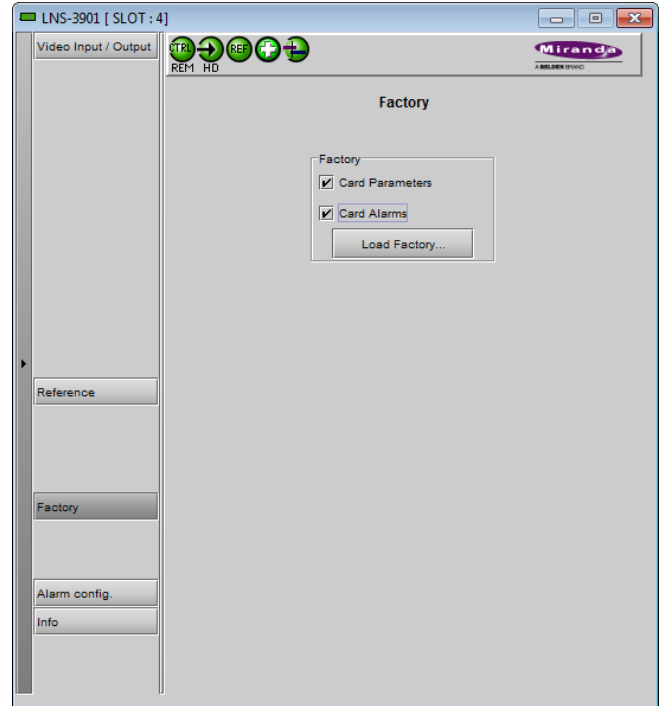

Figure 5-5 Factory / Presets panel

5.5 Alarm Config panel

This panel allows the alarm reporting of the LNS-3901 to be configured. The panel opens in a new window when the button is clicked, and can be resized if needed.

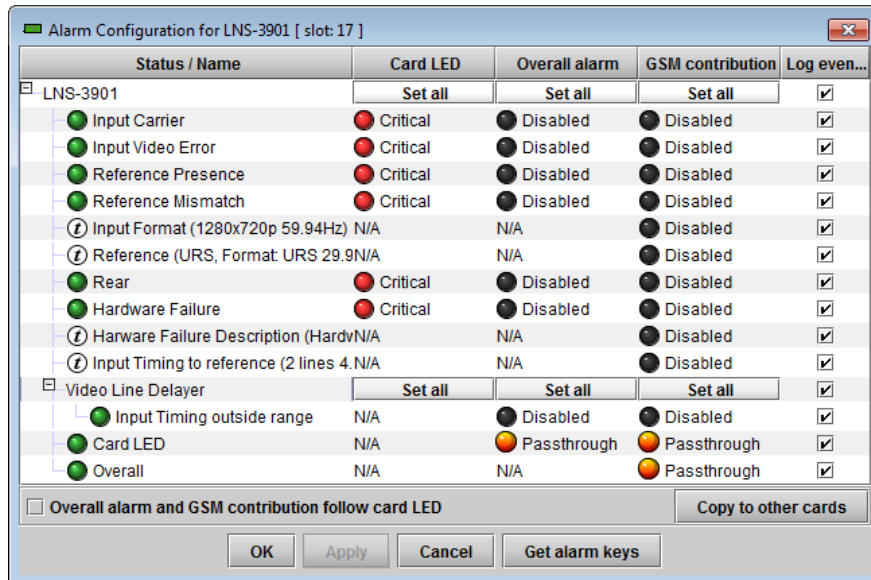

Figure 5-6 Alarm Configuration panel

The panel is organized in columns.

Status/Name

This contains an expandable tree listing all the alarms reported by this LNS-3901 card.

- Each alarm name includes an icon that shows its current status
- Some alarms may be text-only and the alarm status is shown in the name and not by a status icon

The **Card LED**, **Overall alarm** and **GSM contribution** columns contain pulldown lists that allow the level of contribution of each individual alarm to the alarm named in the column heading to be set.

- If there is no arrowhead in the box, there is no pulldown and the alarm is not user-configurable

Card LED

This column allows configuration of the contribution of selected individual alarms to the status LED located on the front card edge. The Card LED status is shown at the bottom of the alarm tree in the Status/Name column.

Overall Alarm

This column allows configuration of the contribution of each individual alarm to the Overall Alarm associated with this card. The Overall Alarm is shown in the upper left corner of the iControl panel, and also appears at the bottom of the Status/Name column.





GSM Contribution

This column allows configuration of the contribution of each individual alarm to the GSM Alarm Status associated with this card. GSM is a dynamic register of all iControl system alarms, and is also an alarm provider for external applications. The possible values for this contribution are related to the Overall alarm contribution:

- If the Overall alarm contribution is selected as Disabled, the GSM alarm contribution can be set to any available value
- If the Overall alarm contribution is selected as any level other than disabled, the GSM contribution is forced to follow the Overall Alarm.

Levels associated with these alarms:

The pulldown lists may contain some or all of the following options:

- | | |
|---|---|
|  Disabled | The alarm makes no contribution (black icon) |
|  Minor | The alarm is of minor importance (yellow icon) |
|  Major | The alarm is of major importance (orange icon) |
|  Critical | The alarm is of critical importance (red icon) |
|  Passthrough | The alarm exists but has no effect (used for text and composite alarms) |

Shortcut: if you click on “Set All” in one of the columns beside a major heading in the Status/Name column, you will open a pulldown list that lets you assign a level to all alarms in that section of the column simultaneously.

Once the alarms are configured, you may accept the changes or discard them:

Log Events

iControl maintains a log of alarm events associated with the card. The log is useful for troubleshooting and identifying event sequences. Click in the checkbox to enable logging of alarm events for each individual alarm.

At the bottom of the window are several other controls

Overall alarm and GSM contribution follow card LED

Click in the checkbox to force the Overall alarm and GSM contribution to be identical to the Card LED status

- All Overall alarms and GSM contributions for which there is a Card LED alarm will be forced to match the Card LED alarm
- All Overall Alarms and GSM contributions for which there is no Card LED alarm will be forced to Disabled

A warning box will open allowing you to confirm the action, since it will result in changes to the configuration and there is no *undo* function.

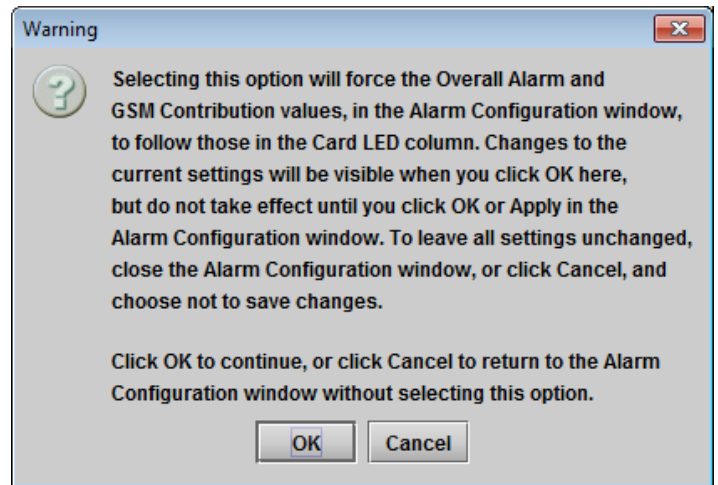

Figure 5-7 Warning for Follow LED change

Copy to other cards

Click this button to open a panel that allows the alarm configuration set for this card to be copied into another LNS-3901 card.

- Select one or more destination cards from the list in the window by clicking in the checkboxes, or all of them by clicking in the *All* checkbox

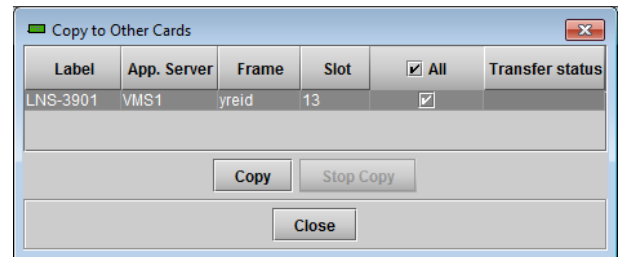

Figure 5-8 Copy to Other Cards window

Get alarm keys

Click this button to open a save dialog where you can save a file containing a list of all alarms on this card and their current values, along with an Alarm Key for each. The alarm keys are useful for system integration and troubleshooting.

- The file is saved in .csv format

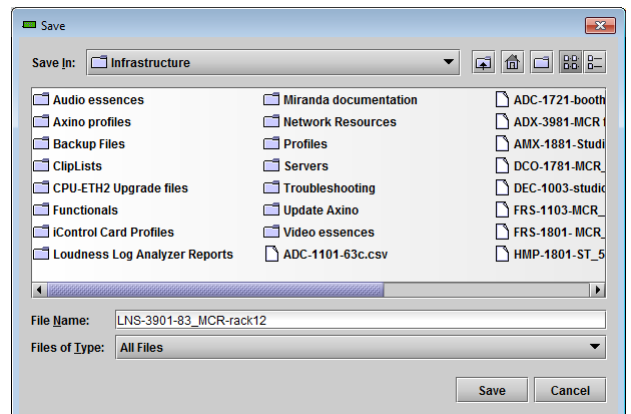

Figure 5-9 Get Alarm Keys dialog

OK, Apply, Cancel

- **OK** accepts the settings and closes the window once the card confirms that there are no errors.
- **Apply** accepts the settings, but leaves the window open
- **Cancel** closes the window without applying any changes, and leaves the previous settings intact.

5.6 Info panel

The top two lines in this panel identify the model of this LNS-3901, and the rear panel that is currently installed.

When the LNS-3901 is included in an iControl environment, certain information about the card should be available to the iControl system. The user can enter labels and comments that will make this card easy to identify in a complex setup. This information is entered into data boxes in the Info control panel.

- Rear Type:** specifies the rear module currently installed.
- Label:** type the label that is shown for this LNS-3901 when it appears in iControl applications
- Short Label** type the short-form label that iControl uses in some cases (8 characters)
- Source ID** type a descriptive name for this LNS-3901
- Comments:** type any desired text

The remaining data boxes show manufacturing information about this card.

Three buttons in the panel give access to other information.

- **Details...:** Reports the Firmware version, service version, and panel version for this card

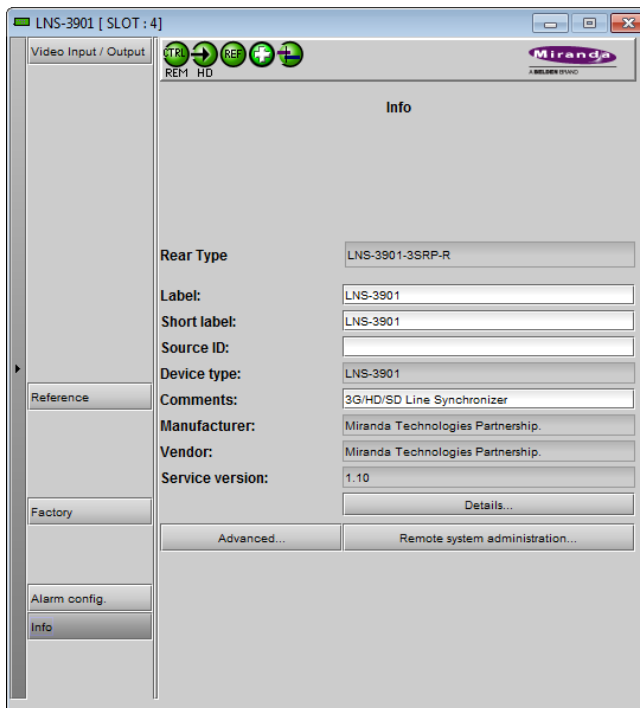

Figure 5-10 Info panel

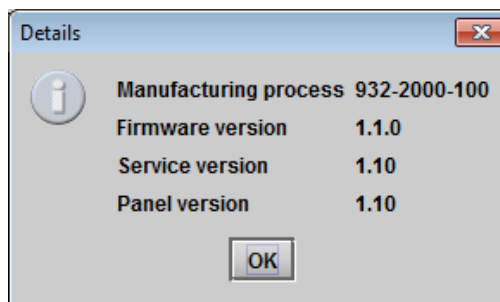

Figure 5-11 Details window

- **Advanced...**: Shows the Miranda LongID for this card. The Miranda LongID is the address of this LNS-3901 in the iControl network.

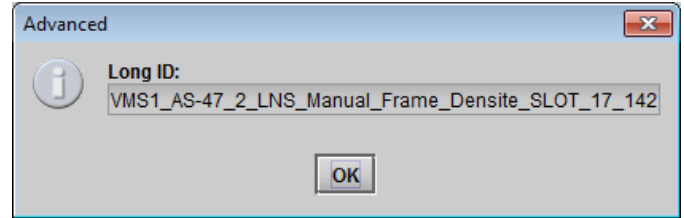

Figure 5-12 Advanced window

- **Remote System Administration** – opens the Joining Locators window, which lists remote lookup services to which this LNS-3901 is registered

Add: Force the iControl service for this LNS-3901 to register itself on a user-specified Jini lookup service, using the following syntax in the data box:

jini://<ip_address>

where <ip_address> is the ip address of the server running the lookup service, e.g.:

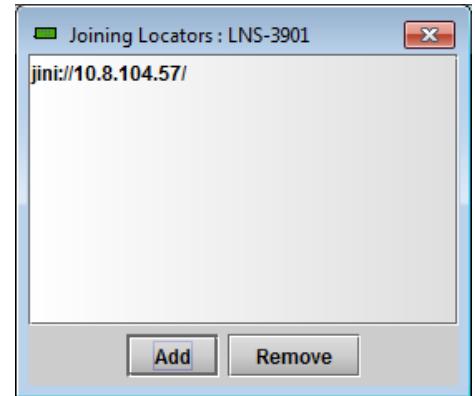
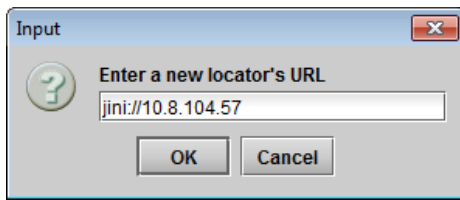
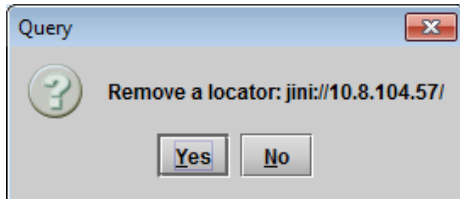

Figure 5-13 Joining Locators window



Remove: select one of the services listed in the window by clicking on it, and click *Remove* to open a query box allowing you to delete it from the window.



6 Specifications

VIDEO INPUT/OUTPUT

Signal (1):	SMPTE-259M-C (270 Mbps), SMPTE-292M (1.485, 1.485/1.001 Gbps), SMPTE-424M (2.970, 2.970/1.001 Gbps)
Supported formats:	SD: 480i59.94, 576i50 HD: SMPTE-274M: 1080i59.94, 1080i50 HD: SMPTE-296M: 720p59.94, 720p50 HD: 1080p23.98SF 3G: 1080p59.94, 1080p50, SMPTE-425M level A, level B (dual link)
Cable length *:	300 m Belden 1694A at 270 Mbps, 150 m Belden 1694A at 1.485 Gbps, 120 m Belden 1694A at 2.970 Gbps
Return loss *:	>15 dB up to 1.5 GHz >10 dB up to 3 GHz
Jitter:	<0.2 UI HD/SD <0.3 UI 3G

REFERENCE INPUT

External - Signal (1)	SMPTE 170M/SMPTE 318M/ITU 624-4 black burst SMPTE 274M / SMPTE 296M tri-level sync
-----------------------	---

VIDEO PROCESSING PERFORMANCE

Signal path:	10 bits
Processing delay:	SD: 7.4 μ s HD: 2.7 μ s 3G: 1.4 μ s
Output timing relative to reference:	From $\frac{1}{2}$ line to 10 $\frac{1}{2}$ lines, user selectable

ELECTRICAL

Power:	11 W
--------	------

* Cable length and return loss specifications will be reduced when using the LNS-3901-3SRP-R rear connector

7 Grass Valley Technical Support

For technical assistance, please contact the Grass Valley Technical Support Center nearest you:

Americas

Office hours: 9:00 a.m. – 9:00 p.m. (EST)
 Telephone: 1-800-547-8949
 +1 530 478 4148
 Fax: +1 514 335 1614
support@grassvalley.com

Asia

Office hours: 9:30 a.m. – 6:00 p.m. (GMT+8)
 Telephone: +852 2539 6987
 Fax: +852 2539 0804
asiatech@grassvalley.com

Europe, Middle East, Africa, UK

Office hours: 9:00 a.m. – 6:00 p.m. (GMT)
 Telephone: +44 118 952 3444
 Fax: +44 118 952 3401
eurotech@grassvalley.com

China

Office hours: 9:30 a.m. – 6:00 p.m. (GMT+8)
 Telephone: +86 10 5873 1814
asiatech@grassvalley.com

Playout Automation – Europe, Middle East, Africa, UK

Office hours: 9:00 a.m. – 5:30 p.m. (GMT)
 Telephone: +44 870 500 4350
 Fax: +44 870 500 4333
automationsupport@grassvalley.com

Malaysia

Telephone: +60 3 2247 1808
asiatech@grassvalley.com

France

Office hours: 9:00 a.m. – 5:00 p.m. (GMT+1)
 Telephone: +33 1 55 86 87 88
 Fax: +33 1 55 86 00 29
eurotech@grassvalley.com

EMERGENCY After Hours (Global)

Toll Free: 1-800-547-8949 (US and Canada)
 Telephone: +1 514 333 1772
 +1 530 478 4148

Corporate Head Office

Grass Valley
 3499 Douglas-B.-Floreani
 St-Laurent, Quebec H4S 2C6
 Canada

Telephone: +1 514 333 1772
 Fax: +1 514 333 9828
www.grassvalley.com

ANNEX 1 – LNS-3901 Local User Interface

Menu level	LEV1	LEV2	LEV3	VALUES
Card Status	STATUS	GENERAL STATUS VIDEO STATUS TIMING		REAR TYPE / FAN ERROR / CRITICAL HEALTH (XXXX XXXX) IN NO CARRIER/ IN FORMAT / IN TRS ERROR / REF FORMAT / REF MISMATCH INPUT IN WINDOW / INPUT TO REF / OUTPUT TO REF
Reference Source	REFERENCE	SOURCE URS		[<u>AUTO</u> , REF, URS, IN] [<u>OFF</u> , URS-29.97, URS-25]
Timing	TIMING	VERT HOR HOR FINE ADJUST		[1,2,3,4,5,6,7,8,9,10] [-1/2 H to 0 to +1/2 H] [-1/2 H to 0 to +1/2 H]
Alarms	CONFIG ALARMS	CARD LED	REF MISSING REF MISMATCH CD ERROR VIDEO ERROR IN OUT OF WINDOW	[FLASHING RED, <u>RED</u> , YELLOW, GREEN] [FLASHING RED, <u>RED</u> , YELLOW, GREEN] [FLASHING RED, <u>RED</u> , YELLOW, GREEN] [FLASHING RED, <u>RED</u> , YELLOW, GREEN] [FLASHING RED, <u>RED</u> , YELLOW, GREEN]
Firmware Version	VERSION			[LNS-3901: XXX, CPU BUILD: XXX, FPGA BUILD: XXX]
Factory Card Parameters	FACTORY RESET	CARD PARAMETERS CARD LED ALARMS		[NO, YES] [NO, YES]

ANNEX 2 – Updating the LNS-3901

If an upgrade of the LNS-3901 software and firmware is required, use the **Densité Upgrade Manager** available through iControl 5.0 and higher to install the upgrade package.

See the iControl User Guide (available under “Documentation” in the iControl Startup page) for detailed instructions.