

IQOTXS Dual-Channel Single-Mode Fibre Optic Transmitter for SDI

Module Description

The IQOTXS is a dual-channel Single-mode (SM) fibre optic transmitter for SDI. The unit takes two inputs of SDI at 270 Mbits/s and provides an optical output for each input in accordance with

SMPTE297M. An equalized monitor output for each of the SDI inputs is also provided.

RollCall provides remote input monitoring and unit identification.

REAR PANEL VIEW

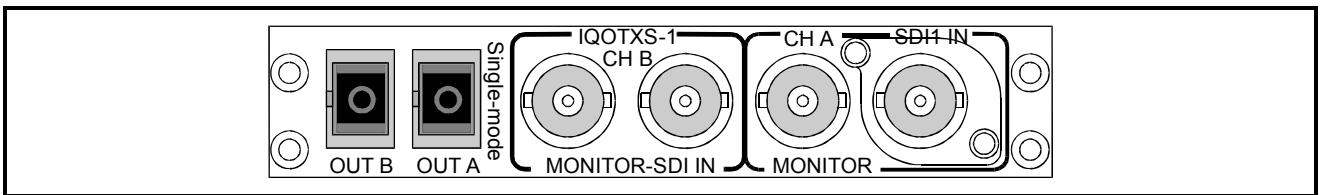

Versions of the module cards available are:

IQOTXS-1	SDI dual-channel fiber optic transmitter (Single-Mode)	Single width module
----------	--	---------------------

IMPORTANT NOTICE

When this module is fitted into a 3U enclosure it is very important to ensure that the card-retaining bar is fitted and fully secured.

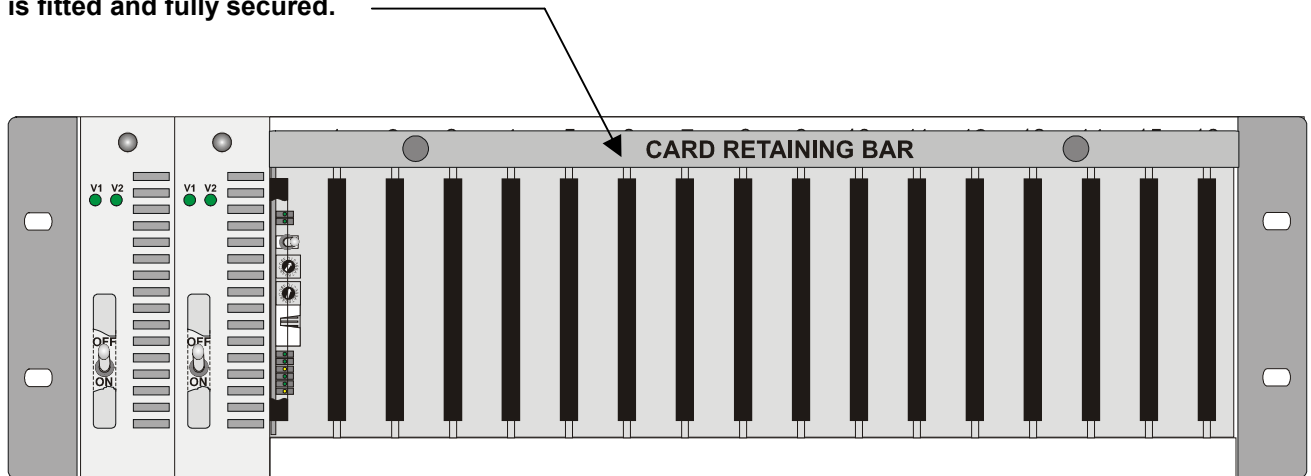

This will make sure that the fiber optic connections at the rear of the module are made correctly.

BLOCK DIAGRAM

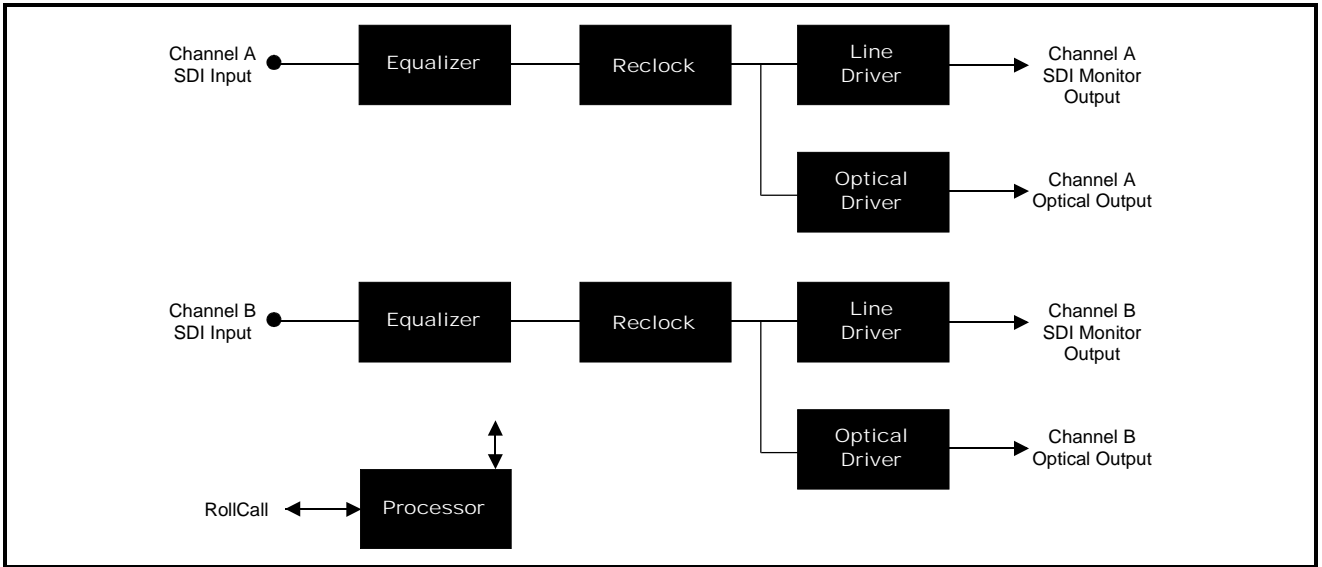

Features

- Dual Single-mode fiber optic transmitter for serial 4:2:2/ASI Signals.
- Single-mode Optical outputs in accordance with SMPTE297M
- Monitor output for each of the serial 4:2:2 inputs.
- RollCall reporting of status
- Freedom from electromagnetic interference
- Freedom from crosstalk
- Complete electrical isolation
- Absence of ground loops
- Increased bandwidth and lower losses than coaxial cables
- Lower weight and higher density compared with copper cables

TECHNICAL PROFILE

Features

Signal Inputs

SDI Channel A Via BNC Connector

SDI Channel B..... Via BNC Connector

Signal Outputs

Optical Channel A..... Via Single-Mode SC Connector with Shutter

Optical Channel B..... Via Single-Mode SC Connector with Shutter

SDI Monitor Channel A Via BNC Connector

SDI Monitor Channel B..... Via BNC Connector

Controls

None

Additional Controls via RollCall™ Remote Control System

Logging Input Loss

Indicators

Power Supplies

Input Loss

Specifications

Optical Output Power -8 dBm Typical

Optical Output Wavelength..... 1310 nm ±40 nm

SDI Output 270 Mbits/s

SDI Output Return Loss..... Better than -15 dB to 270 MHz

Operating Distance 20 km typical with high quality cable

INPUTS AND OUTPUTS

CHANNEL A AND CHANNEL B SDI INPUTS

These are the two inputs of SDI for each of the two channels via BNC connectors.

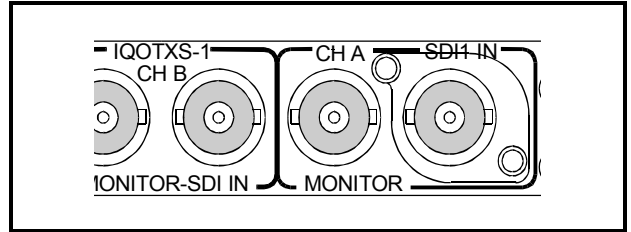

MONITOR

These are the channel A and channel B monitor outputs which provide equalized monitor outputs for each of the SDI input channels via BNC connectors.

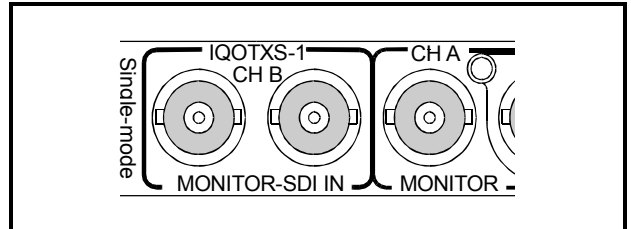

OUTPUT A and OUTPUT B

These are the channel A and channel B optical outputs from the unit that are made via SC Connectors with Shutters.

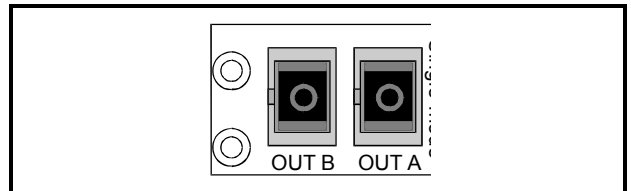

CARD EDGE CONTROLS



LED INDICATORS

+Pwr and -Pwr

When illuminated these LED's indicate that the positive and negative power supplies are present.

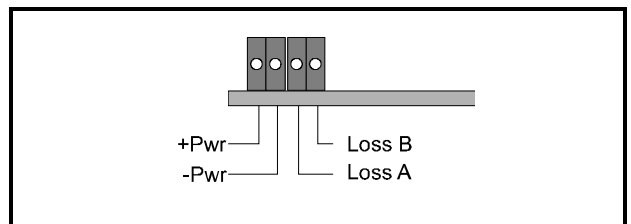

Loss A

This LED will be continuously illuminated when Input A is not receiving an input signal.

Loss B

This LED will be continuously illuminated when Input B is not receiving an input signal.

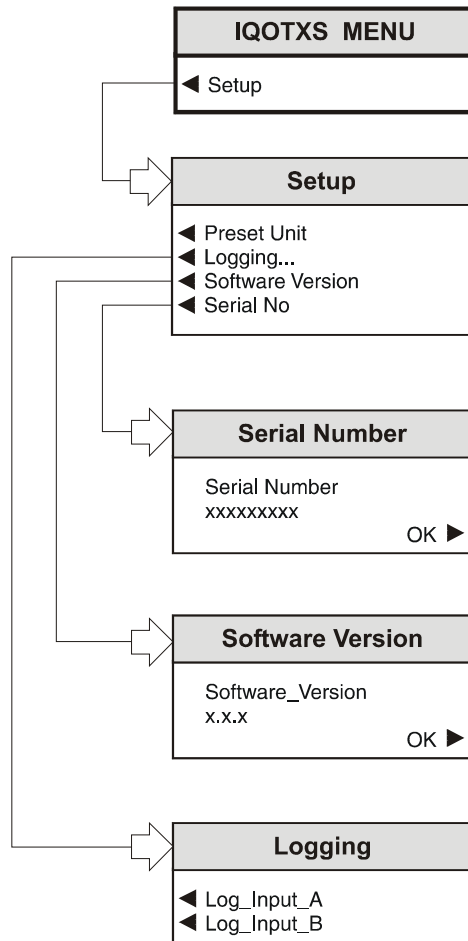

***IQOTXS
Menu System***

OPERATION FROM AN ACTIVE CONTROL PANEL

The card may be operated with an active control panel via the RollCall™ network. The menus available for this card are shown opposite and will appear in the Control display window.

Operational details for the remote control panel will be found in SECTION 1 of the Modular System Operator's Manual.

MENU DETAILS

(see IQOTXS Menu System on previous page)

MAIN MENU

The main, or top level menu allows various sub-menus to be selected by pressing the button adjacent to the required text line.

Note that where a menu item is followed by three dots (...) this indicates that a further sub-menu may be selected.

Whenever a menu item is selected the parameters of that selection will be displayed in the **Information** window of the front panel. Where the selection is purely a mode selection and does not enable a sub-menu, the text will become reversed (white-on-black) indicating that the mode is active. If the mode is not available for selection the text will remain normal.

◀ Setup

This selection reveals a sub-menu that allows various functions to be set.

◀ Preset Unit

Selecting this item sets all adjustment functions that include a preset facility, to their preset values.

Note that this is a momentary action and the text will not become reversed

◀ Logging

If a logging device is attached to the RollCall™ network, information about various parameters will be reported to the logging device assigned in the Remote Control Interface system. (See Section 1, The RCIF Menu System)

The parameters that may be selected for logging are as follows:

- ◀ Log_Input_A
- ◀ Log_Input_B

When activated, a loss of input signal condition for the two inputs will be available for the logging device.

◀ Software Version

Selecting this item reveals a display showing the version of the software fitted in the module. Select OK to return to the Setup Menu.

◀ Serial Number

Selecting this item reveals a display showing the serial number of the module. Select OK to return to the Setup Menu.

THE INFORMATION WINDOW

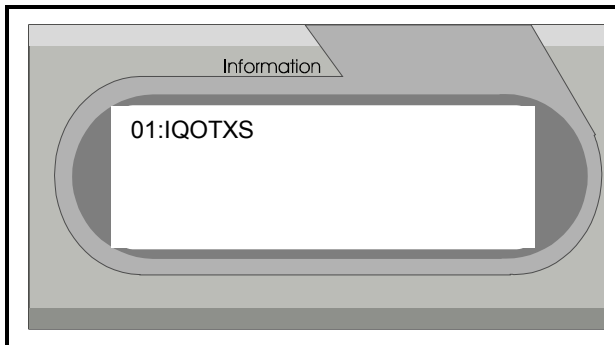

The Information window has four lines of text indicating current selections and various information messages.

The first line will contain the name of the module that is currently being controlled.

The second, third and fourth lines provide specific information about the operating conditions of the module.

Example of text displayed

Line 1 01:IQOTXS
 Line 2 INPUT_A:OK or **
 Line 3 INPUT_B:OK
 Line 4 Not used

Text Line Details

Line 1

This line contains the name of the module and Gateway code data.

Line 2

This line gives information about the state of the input channel A.

INPUT_A : OK *Input Signal Present*
 or
 INPUT_A : ** *Input Signal not Present*

Line 3

This line gives information about the state of the input channel B.

INPUT_B: OK *Input Signal Present*
 or
 INPUT_B: ** *Input Signal not Present*

Line 4

This line is not used and will be blank.

