

RPAN

Router Control Panel

Operator's Manual

© June 2006

www.snellwilcox.com

Snell & Wilcox Ltd., Southleigh Park House, Eastleigh Road, Havant, Hants, PO9 2PE, United Kingdom.

For technical assistance contact: Tel: +44 (0)23 9248 9000 Fax: +44 (0)23 9245 1411

For general and sales assistance contact: Tel: +44 (0)20 8917 4300 Fax: +44 (0)20 8607 9466

About this Manual

This manual covers the following products:

- RPAN RollCall Remote Control Pod

Packing List

The unit is supplied in a dedicated packing carton provided by the manufacturer and should not be accepted if delivered in inferior or unauthorised materials. Carefully unpack the carton and check for any shipping damage or shortages.

Any shortages or damage should be reported to the supplier immediately.

Enclosures:

- RPAN Router Control Panel
- Switch cap removal tool (part number H9 SS6697) 1 piece
- Mains Adapter Power supply
- Operator's Manual

Software Version Amendments

Notes about Versions Fitted

Software. This unit is fitted with Version 1.2.1 Issue of the Software

Manufacturers Notice

Copyright protection claimed includes all forms and matters of copyrightable material and information now allowed by statutory or judicial law or hereinafter granted, including without limitation, material generated from the software programs which are displayed on the screen such as icons, screen display looks etc.

Reproduction or disassembly of embedded computer programs or algorithms prohibited.

Copyrighted names: Microsoft Windows™

Information in this manual and software are subject to change without notice and does not represent a commitment on the part of Snell & Wilcox Ltd. The software described in this manual is furnished under a licence agreement and may not be reproduced or copied in any manner without prior agreement with Snell & Wilcox Ltd. or their authorised agents.

Safety Standard

Pending



EMC Standards

This unit conforms to the following standards:

BS EN 55103-1 : 1997

Electromagnetic Compatibility, Product family standard for audio, video, audio-visual and entertainment lighting control apparatus for professional use. Part 1. Emission

BS EN 55103-2 : 1997

Electromagnetic Compatibility, Product family standard for audio, video, audio-visual and entertainment lighting control apparatus for professional use. Part 2. Immunity

Federal Communications Commission Rules Part 15, Class A :1998

EMC Environment

The product(s) described in this manual conform to the EMC requirements for, and are intended for use in, *either*

The commercial and light industrial environment (including, for example, theatres) E2

or

The controlled EMC environment (for example purpose-built broadcasting or recording studios), and the rural outdoor environment (far away from railways, transmitters, overhead power lines, etc.) E4

The applicable environment is stated in the Technical Profile section of the product operation manual under "*EMC Performance Information/Environment.*"

EMC Performance Information

Please refer to the *Technical Profile/Specifications* section of the product operation manual.

EMC Performance of Cables and Connectors

Snell & Wilcox products are designed to meet or exceed the requirements of the appropriate European EMC standards. In order to achieve this performance in real installations it is essential to use cables and connectors with good EMC characteristics.

All signal connections (including remote control connections) shall be made with screened cables terminated in connectors having a metal shell. The cable screen shall have a large-area contact with the metal shell.

COAXIAL CABLES

Coaxial cables connections (particularly serial digital video connections) shall be made with high-quality double-screened coaxial cables such as Belden 8281 or BBC type PSF1/2M.

D-TYPE CONNECTORS

D-type connectors shall have metal shells making good RF contact with the cable screen. Connectors having "dimples" which improve the contact between the plug and socket shells, are recommended.

Table of Contents

SECTION

1	Introduction	
	Description and Features	1.1
2	Specifications	2.1
3	Installation	
	Unpacking	3.1
	Power Connections	3.1
	Communication Connections	3.2
4	Operation	
	General Description.....	4.1
	Software Description	4.3
	General Principles of Operation	4.3
	Front Panel Operation	4.4
	Button States	4.8
	Panel Configuration.....	4.9
	Setup Page/Menus	4.11

Description

The RPAN provides button per source or global x-y control of routers over the RollCall network.

RPAN Router Control Panels are for use with any RollCall-compatible routers, such as the IQDRT8, (8 by 8 SDI video router), IQDRT6, (6 by 4 SDI video router), the IQBRT8, (8 by 8 AES audio router), the IQDMX8, (8 by 1 SDI multiplexor), the IQDMX4, (4 by 1 SDI multiplexor), and the HD1132 HD SDI router family.

Various button layouts, to control between 1 and 8 destinations, between 1 and 8 sources, and between 1 and 2 levels. All buttons can carry user-inserted legends to identify the source, destination, or level for that button. Illuminated buttons provide tally information to confirm selection or indicate problems.

Connection to router is via RollNet coax or RS485 network. Connection to configuration client is via RollNet coax or RS485 network, or RollCall RS422.

Features

- Single button per Source
- Single button per Destination (optional)
- Single button per Level (optional)
- In button LED tally including input signal status
- RollNet high speed connection
- Dual redundant power supply option
- Ideal for Control of any RollCall compatible router products such as the S&W IQDRT, IQBRT, or IQDMX series
- Can control any serially interfaced router via an IQCSPi serial interface module (available separately)

MODELS AVAILABLE

RPAN-8-1-1 Button per source. 8 x 1 x 1



RPAN-8-8-1 Global x-y. 8 x 8 x 1



RPAN-8-1-2 Button per source for Video and Audio. 8 x 1 x 2



RPAN-8-8-2 Global x-y for Video and Audio. 8 x 8 x 2

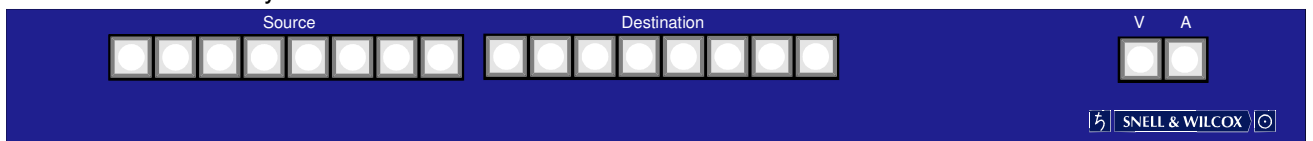

Rear Panel View

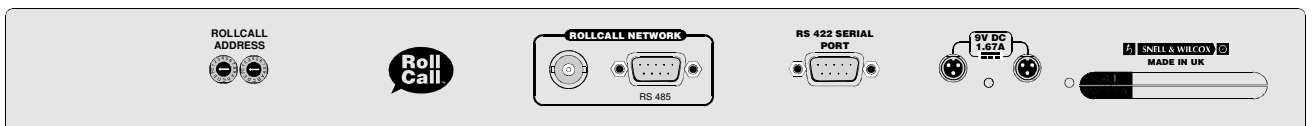

Specifications

Features

Control Interface

RollNet Coaxvia BNC connector
 RollNet RS485.....via 9 way D type connector
 RollCall RS422via 9 way D type connector
 Controls
 Hard Keys.....Up to 18
 Indicators

Hard Keys..... Multi colored
 Additional Controls via RollCall™ Remote Control System

Target router(s) configuration

Hard button LED brightnessAdjustable
 Power and temperature monitoring

Specifications

PowerVia dual redundant mains operated external adapters
 Input 100-240V AC @ 47 to 63 Hz
 1A max
 Output + 9V DC at 1.67 A
 Power Consumption5.4VA max

Temperature Range..... 0° to 40° C operating
 Case Type 1U rack mounting steel case
 Dimensions..... 483 mm x 198 mm x 44.4 mm (w, d, h)
 Weight Approximately 1kg.

Installation

Unpacking the RPAN

The unit is packed in a single carton. The contents are as follows:

- RPAN unit
- 1 Switch cap removal tool (part number H9 S6697)
- 2 Power cables
- 1 Mains adapter
- 1 Operating Manual

Unpack the carton carefully and check for any shortages or shipping damage. Immediately report any shortages or damage to Snell and Wilcox Limited.

POWER CONNECTIONS

Mains power is supplied to the mains adapter via an IEC connector.

Power Supply

Power is provided for the unit via the supplied mains adapters. Two mains adapters are provided and both may be connected to the unit using the 3-pin connectors. This provides power supply redundancy so that if one supply fails the unit will continue to operate normally.

Supply Voltage

The power supplies are auto switching for input voltages in the range of 100 V to 250 V nominal.

No voltage adjustment procedure is required.

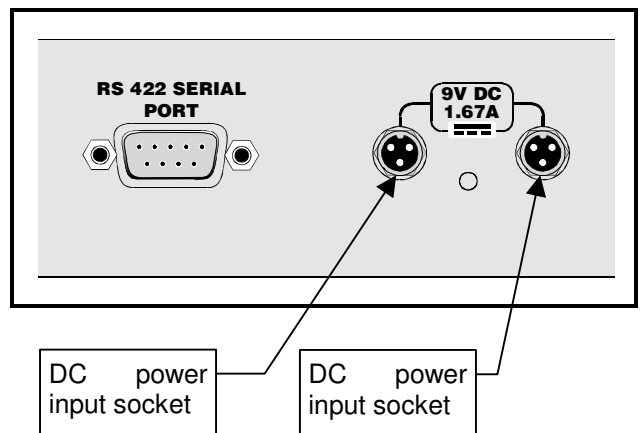
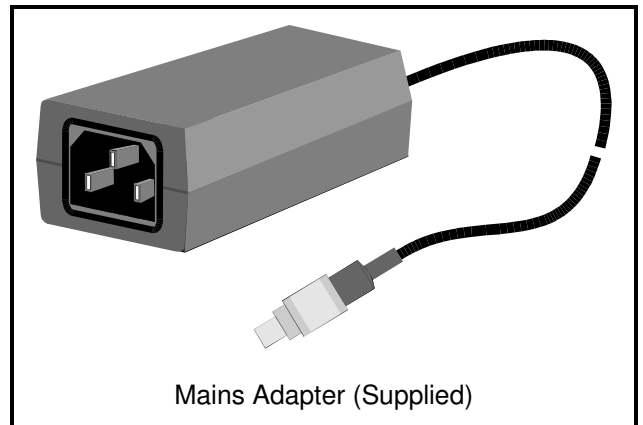

COMMUNICATION CONNECTIONS

RollCall Network

The single BNC connector allows the unit to be connected to the RollCall™ network communications system.

The 9 pin `D' connector on the rear panel allows the unit to be connected to the RollCall™ 485 network communications system.

The RS485 communications runs at 2.5 Mbit/s (high speed).

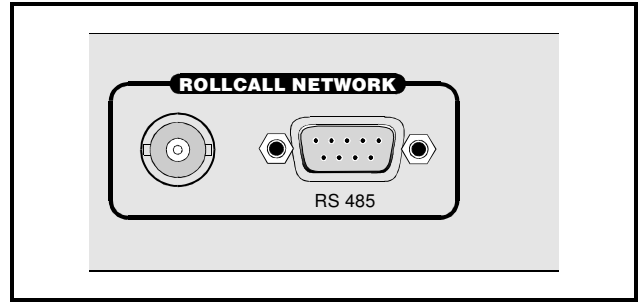

RollCall Address

Both of these switches are used to define the Unit Address code for the equipment. The settings of these switches are read continuously and a new address will be registered within a few seconds.

Position `0' on the left-hand switch will disable the RollCall function on the unit; all other positions on these switches may be used to set the Unit Address code in Hex.

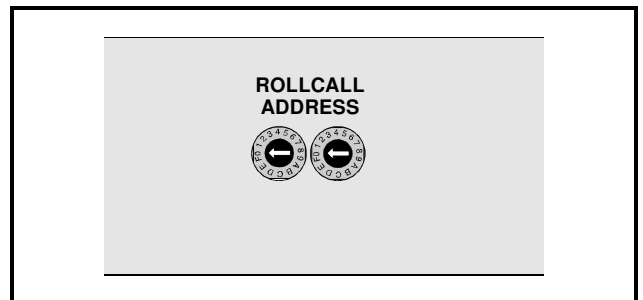

Note that in a RollCall local network, all units must have different unit address codes.

RS 422 Serial Port (RollCall Control Only)

This 9 pin `D' connector on the rear panel allows the unit to be connected to an RS422 RollCall controller such as a personal computer.

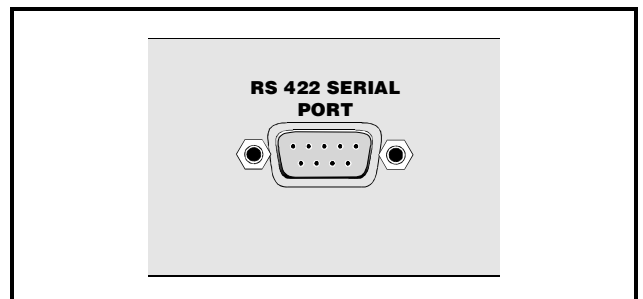

Operation

GENERAL DESCRIPTION

The RPAN provides button per source or global x-y control of routers over the RollCall network.

RPAN Router Control Panels are for use with any RollCall-compatible routers, such as the IQDRT8, (8 by 8 SDI video router), IQDRT6, (6 by 4 SDI video router), the IQBRT8, (8 by 8 AES audio router), the IQDMX8, (8 by 1 SDI multiplexer), the IQDMX4, (4 by 1 SDI multiplexer), and the HD1132 HD SDI router family.

Various button layouts are available to control between 1 and 8 destinations, between 1 and 8 sources, and between 1 and 2 levels. All buttons can carry user-inserted legends to identify the source, destination, or level for that button. Illuminated buttons provide tally information to confirm selection or indicate problems.

Connection to router is via RollNet coax or RS485 network. Connection to configuration client is via RollNet coax or RS485 network, or RollCall RS422.

REAR PANEL VIEW

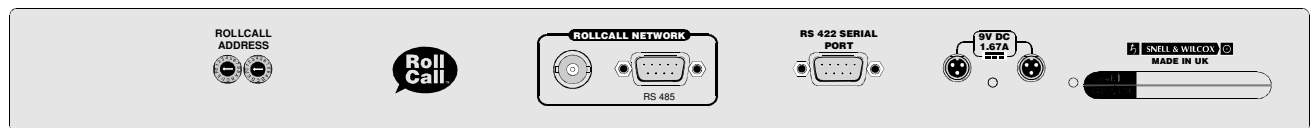

MODELS AVAILABLE

- RPAN-8-1-1 Button per source control panel, single destination, and single level.
- RPAN-8-8-1 XY control panel, single level.
- RPAN-8-1-2 Button per source control panel with Audio and Video selection.
- RPAN-8-8-2 XY control panel with Audio and Video selection.

DESCRIPTION FOR SPECIFIC MODELS

RPAN-8-1-1



For use as a button per source control panel with a single router level. 8 buttons are provided to select sources to the assigned destination and level.

RPAN-8-8-1

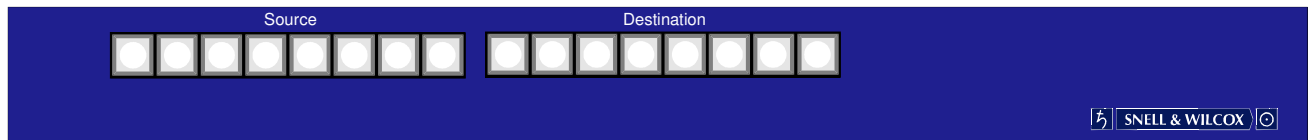

For use as a XY control panel with a single router level. 8 buttons are provided to select sources to the assigned destination. Another 8 buttons are provided to select the destination of interest.

RPAN-8-1-2



For use as a button per source control panel with 2 router levels. 8 buttons are provided to select sources to the assigned destination. Separate buttons select level control, i.e. Video control only, Audio control only, both Video and Audio control, or no control.

RPAN-8-8-2



For use as a XY control panel with 2 router levels. 8 buttons are provided to select sources to the assigned destination. Another 8 buttons are provided to select the destination of interest. Separate buttons select level control, e.g. Video control, Audio control or both Video and Audio.

GENERAL PRINCIPLES OF OPERATION

Cross point control

No user action will result in cross point changes except pressing a source button. Specifically, no cross point change will ever occur when the level or destination buttons are pressed, or when any configuration menus are changed.

Cross point display

At any time, the display of cross points on the panel will agree with the actual router cross point status. If the panel is unable to show cross points reliably for any reason, then the error-state of flashing red will be used to indicate this. This applies to both true connected and simulated-connected polled-blind connections.

Button colour usage

Flashing Red

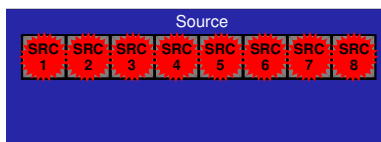

This indicates the system is mis-configured or broken. Red always flashes, and can be bright or dim.

Green.

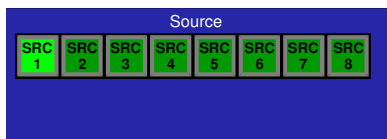

This indicates the system configured and working OK

Bright green/orange

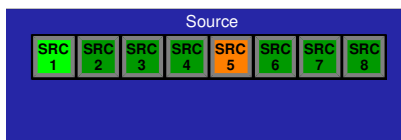

This indicates the currently selected source, destination, and/or level.

Dim green

This indicates a NOT currently selected source, destination, and/or level.

Off indicates not available, whether source, destination, or level.

Flashing indicates a problem.

Green/orange flashing means communication are OK, but signal path problem.

Red flashing means system/communication error.

Orange means levels are split, i.e. for the current destination, the 2 routers being controlled by the two levels have different source selections.

The level 1 button and level 1 source will be shown green, while the level 2 button and level 2 source will be shown orange.

FRONT PANEL OPERATION

Based on the general principles of operation, this section shows a non-exhaustive list of typical operation conditions, and the LED display that would be seen.

1 Power Up

At power up the LED's in all buttons will flash red until communication is established with the router.

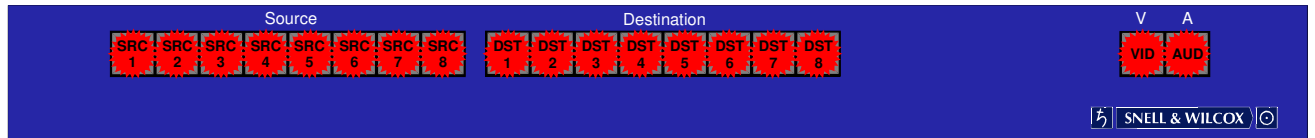

1.2 Interrogate at power up.

Once the panel is connected to the router, it will send an Interrogate message. At this stage, with no button press, the XY panel will remember the last destination before powering down. The router will reply with a Tally, which will update the status of the panel. Setting the LED in the button of the Source selected to Destination 0, to bright green, all other buttons to the background colour, (defined to be dim green).

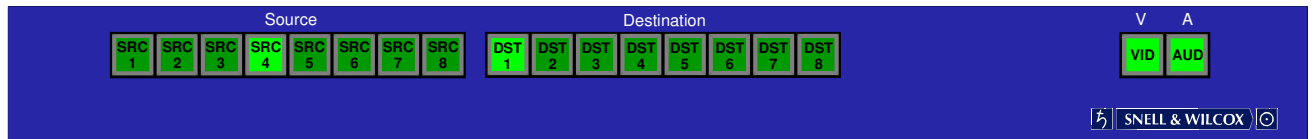

2.1 Interrogate at user request.

If the user changes Destination by pressing a button, in this case changing from TX1 to TX2. The panel will send an Interrogate message to find which Source is connected to Destination TX2. The router will reply with a Tally, which will update the status of the panel. Setting the LED in the button of the Source selected to Destination TX2, to bright green, all other Source buttons to the background colour.



2.2 Interrogate video and audio non tracking.

If the Video and Audio Routers have different Sources selected to the same Destination then the LED in the button for the Video Source will be bright Green and the LED in the buttons for the Audio Source & Audio Level will be Bright Orange.



3.1 Selection Audio follow Video.

When a new Source is selected, by pressing a button, the panel will send a Connect message to both Video and Audio routers, requesting the source selected to be routed to that destination.



3.2 Selection Audio only.

Press the button marked Video on the right hand side of the panel. This will turn from Green to background colour to indicate the panel is no longer making selections on the Video Router. When a new Source is selected, by pressing a button, the panel will send a Connect message to Only the Audio router, requesting the source selected to be routed to that destination.



3.3 Selection Video only.

Press the button marked Audio on the right hand side of the panel. This will turn from Green to background colour to indicate the panel is no longer making selections on the Audio Router, ensure the Video button is bright green. When a new Source is selected, by pressing a button, the panel will send a Connect message to Only the Video router, requesting the source selected to be routed to that destination.

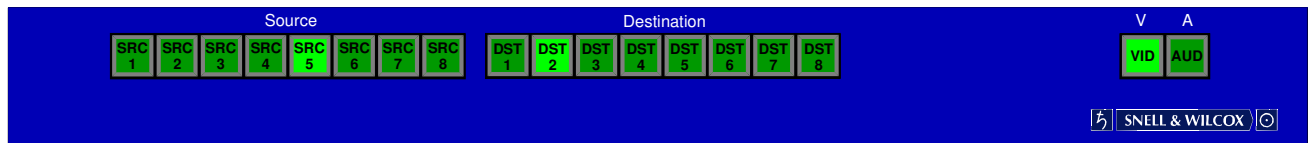

4 Good Connection

When the router establishes the requested path it will generate a Connected message. This contains details of the routed path and the status of the selected input. If the path was connected and the selected source had a valid input the LED in the last Source will be switched off and the LED in the new Source will be switched on.



5.1 Bad Connection Video.

When the router establishes the requested path it will generate a Connected message. This contains details of the routed path and the status of the selected input. If the path was connected and the selected Video source did not have a valid input the LED in the last Source will be switched off and the LED in the new Source and the Video level button would flash.

Where the router supports monitoring the input status independent of cross point selection, (true for IQDRT and IQBRT, but not true for IQDMX), then additionally the other source buttons would flash from their background colour of dim green if the corresponding router input does not have a valid input. However, the flashing of the level buttons will match only the current source selection, and will not be affected by the signal status of the other sources.



5.2 Bad Connection Audio.

When the router establishes the requested path it will generate a Connected message. This contains details of the routed path and the status of the selected input. If the path was connected and the selected Audio source did not have a valid input the LED in the last Source will be switched off and the LED in the new Source and the Audio button would flash.



6.1 No Connection Video.

If communication with the Video router is lost, the panel will time out after waiting for the Connected message. Because the path was not connected, the LED in the last Source will be switched to flashing red, to indicate this was the last selected Source and beyond that system status is unknown. All other sources will show flashing dim red. The Video button will flash red to indicate it is the Video router that has lost communication. The destination button will flash red to show this is the destination that has the communication problem.



6.2 No Connection Audio.

If communication with the Audio router is lost, the panel will time out after 0.5 second waiting for the Connected message. Because the path was not connected LED in the last Source will be switched to flashing red, to indicate this was the last selected Source and beyond that system status is unknown. The Audio button will flash red to indicate it is the Audio router that has lost communication.



7 Connection From Another Control Unit

If another controlling unit changes a source connected to this destination the panel will receive the Connected message, output by the router on all control ports. This contains details of the routed path and the status of the selected input. If the path was connected and the selected source had a valid input the LED in the last Source will be switched off and the LED in the new Source will be switched on. . If the path was connected and the selected source did not have a valid input the LED in the last Source will be switched off and the LED in the new Source would flash.



BUTTON STATES

Based on the general principles of operation, this section shows a non-exhaustive list of typical operation conditions, and the LED display that would be seen.

Terminology for these tables: "Connection"/ "connected" refers to RollCall connection, whether true connected or simulated polled blind connection. Routed refers to target router cross point. "Bad" signal means that the panel is set to read the input status from the router, and has read that the signal is missing. "Not bad" signal means that either the panel has read from the router that the signal is OK, or that the panel is not set to read the input status from the router. N.B. if the panel is set to read the input status, but is unable to read it, then this counts as failed connection, and the system error state of flashing red would over-ride the green signal presence display.

State of Source buttons	Colour	Brightness	Flash
This source routed to current destination at all current levels, not-bad signal, (either good or unknown)	Green	High	No
Source routed at all current levels, bad signal on at least 1 active level	Green	High	Yes
Source not routed to current destination at any current levels, or no levels active, not-bad signal	Green	Low	No
Source not routed at any current levels, or no levels active, bad signal on at least 1 active level	Green	Low	Yes
Source routed at level 1 only with both levels active, not-bad signal on level 1	Green	High	No
Source routed at level 1 only with both levels active, bad signal on level 1	Green	High	Yes
Source routed at level 2 only with both levels active, not-bad signal on level 2	Orange	High	No
Source routed at level 2 only with both levels active, bad signal on level 2	Orange	High	Yes
Unknown, i.e. RollCall connection failed, but last known source is this one	Red	High	Yes
Unknown, i.e. RollCall connection failed, but <i>not</i> last known source	Red	Low	Yes
Source not configured for current destination and level, or no destination/level selected	Off	Off	No

State of Destination buttons	Colour	Brightness	Flash
Active destination, connection OK at all current levels where configured, at least 1 level configured	Green	High	No
Inactive destination, connection OK at all current levels where configured, at least 1 level configured	Green	Low	No
Active destination, connection failed at some current levels	Red	High	Yes
***Inactive destination, connection failed at some current levels	Red	Low	Yes
Destination not configured at any current level, or no levels selected	Off	Off	No

State of Level buttons	Colour	Brightness	Flash
Level active, and connection OK at current destination for this level	Green	High	No
Level inactive, and connection OK at current destination for this level	Green	Low	No
Level active, and connection failed at current destination for this level	Red	High	Yes
Level inactive, and connection failed at current destination for this level	Red	Low	Yes
(Level 2 only:) Level active, and connection OK at current destination for this level, but source for this destination/level is different to source for same destination on level 1.	Orange	High	No

STATE OF ALL BUTTONS

User has selected "WhereAmI" feature from RollCall Control. This allows the user to physically identify which panel they are remote controlling. Colour: Orange, Brightness: High, Flash: Yes.

RollCall address clash detected. This network configuration error is detected on power up or on address change, if another unit on the network is currently using the chosen address for this unit. Colour: Alternating Red/Orange, Brightness: High, Flash: Yes.

RollCall Control Templates for RPAN

Control Local

This section shows how the control panel is configured to control modules.

The default configuration is for:

IQDRT8/IQBRT8/QSRT00/QSRT10.

Other examples are shown on pages 11 and 12.

The user needs to set the address of each module and also the command number and value offset that will switch the appropriate source for each destination. The RollCall Control Panel screens are shown below.

The RollCall command value sent to the router will be equal to "Offset + Source Number - 1". E.g. if value offset is 0, then for inputs 1 to 8, the values 0 to 7 will be sent.

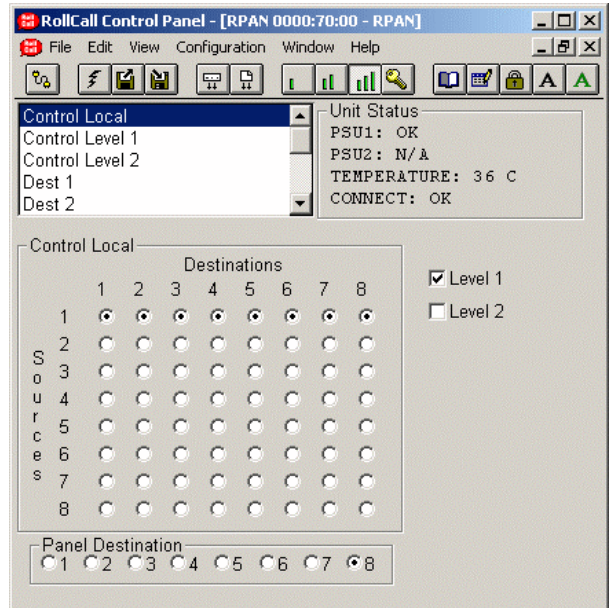

8 Button Panels Configuration

In this case only Level one is used as only one module is to be controlled per destination. The destination is selected by **Panel Destination** function.

Information Window

PSU1 and PSU2 status. Temperature. Voltages. Connection(s) status as either all OK, or not. Where all detail doesn't fit, display menu line show more details, e.g. individual connection statuses for each of the 16 connections. (See destination setup menus.) PSU, temp, and voltage display can be modelled on new 3U gateway.

Crosspoint Matrix

Show column and row headers, i.e. Inp 1 2 3 4 etc.

Control Level 1, Level 2

Non-configured destinations are greyed out, corresponding to button LED off and not selectable. It is allowed to have no active destinations, or exactly 1 active destination.

Cross point source buttons for non-configured destinations are greyed out, (corresponding to button LED off and not selectable), and so are source buttons beyond the specified source count. It is allowed to have no active destinations, or 1 active destination, or 2 active destinations in the split dual-level case.

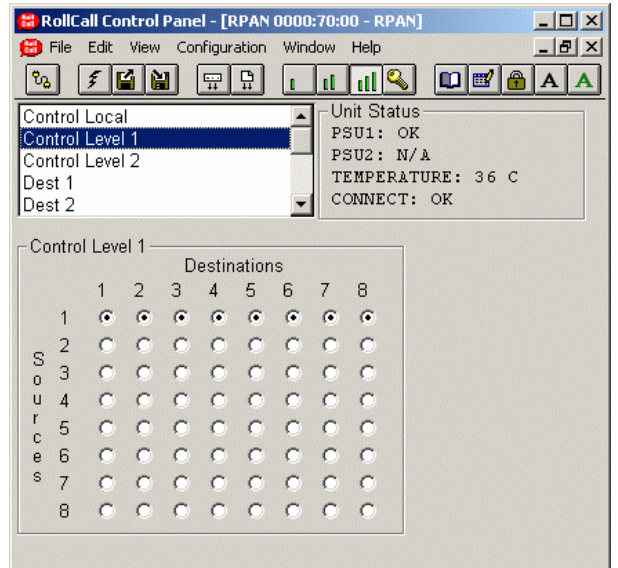

Dest 1 to Dest 8

For each destination and level, the following parameters are set:

Destination 1 to 8 Level 1 and 2

This section allows the parameters for the 8 destinations to be set.

Enable When selected the parameters will be enabled. Default is to selected.

Connection Status
This will show the connection status. Blind or Connected, default is to Connected

Address (RollCall)
This function allows the address of the RollTrack compatible module to be entered for each of the router outputs.

The full network address has three sets of numbers.

The first set (0000) is the network segment code number.

The second set (00) is the number identifying the (enclosure/mainframe) unit.

The third set (00) is the slot (Port) number in the unit.

To change the address, type the new destination in the text area and then select  (return)

 (Preset) returns to the default destination 0000:00:00.

Command (RollCall)
This is the RollCall command number.
The default as per IQDRT8
For details of the RollCall command numbers for specific units please contact your local Snell & Wilcox agent.

Take Command
This is the RollCall Take command number.
default as per DRT8

Enable
When selected the Take Command will become enabled. Default is to not selected.

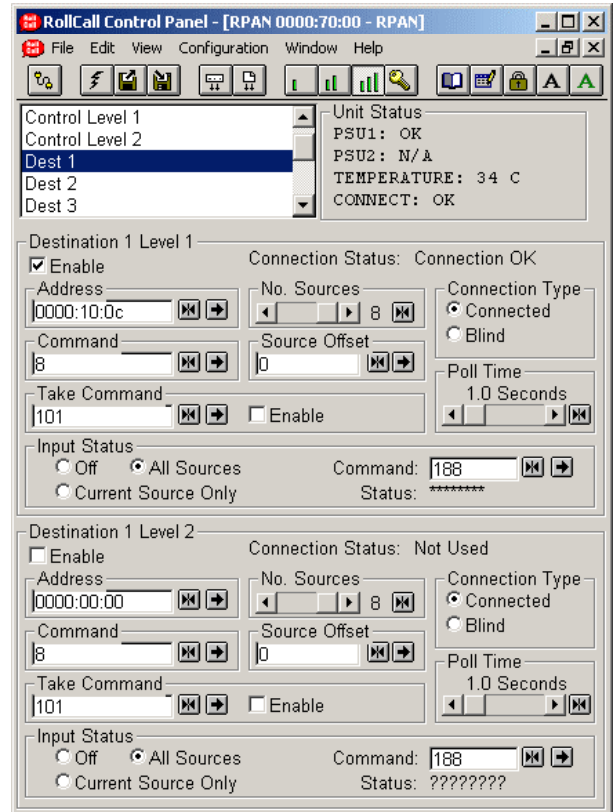

RPAN connected to BRT8/DRT8/SRT00/SRT10.

No. Sources
This shows the number of valid sources available to be selected for this destination. It may be set from 1 to 8 and preset is to 8.

For example, if there are only 4 valid sources available they should be grouped together as a block and this function set to 4. This will prevent an invalid source from being selected. Used in conjunction with the Source Offset a particular number of grouped sources may be defined.

Source Offset
This shows the number of contiguous valid sources starting from source offset. The scrollbar allows numbers from 2 to 8 to be selected. e.g. if Offset = 0, and Number = 3, then sources 1, 2, 3 will be enabled, corresponding to command values 0, 1, 2.

Default is to 0.

Connection Type
This function allows the connection to be either Connected or Blind.

Dest 1 to Dest 8 (cont)

Poll Time (applies to blind connection only)

The scrollbar allows the Poll Time to be adjusted over the range of 1 second to 10 seconds in 0.1 second steps. Default is to 1 second.

Status display:

“Blind poll OK/Failed” or “Connection OK/Failed” or “Not Used”. The latter indicates no or incomplete configuration, e.g. zero rUnit, empty or 0 command numbers, or control check box disabled.

Input Status

This function allows various types of information concerning, the input status, to be selected.

Read Input Status mode radio buttons:

Off

This is the default selection and when selected the function will not be active.

All Sources

When enabled all sources will be selected.

Current Source Only

When enabled only the current source will be selected.

Command

This reads the Input Status Command Number,

In “All Sources” mode, a contiguous block of command numbers will apply to inputs 1 to n, e.g. 188,189.... In “Current Source Only” mode, only the specified command number will be read. default as per DRT:188.

Status

This shows one character per input.

Character “*” indicates this input is read as lost.

Character “?” indicates there is no information for this input, (e.g. Current Source Only mode, or not configured, or connection failed.)

Character n for source number indicates this input is read as OK.

Examples: “123**6*8”, “???4????”, “***4”, “????????”.

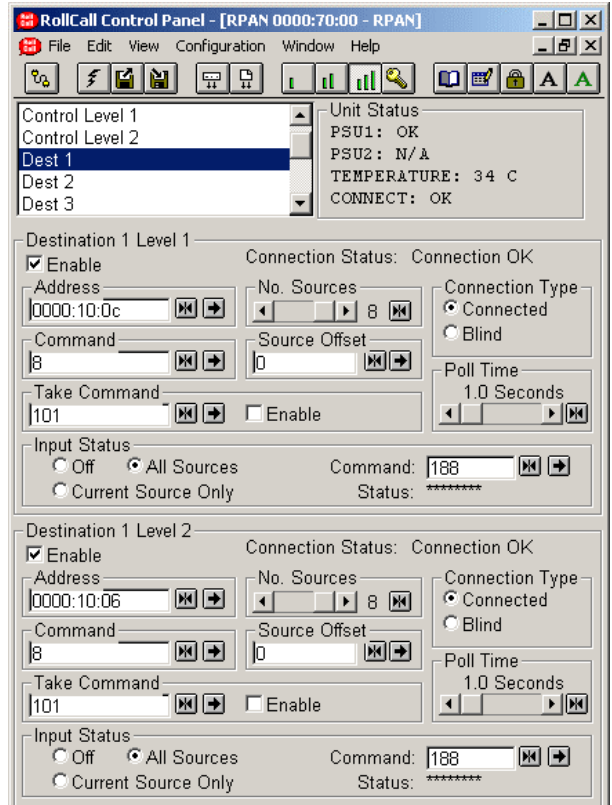

RPAN connected to BRT8/DRT8/SRT00/SRT10 in multi level configuration.

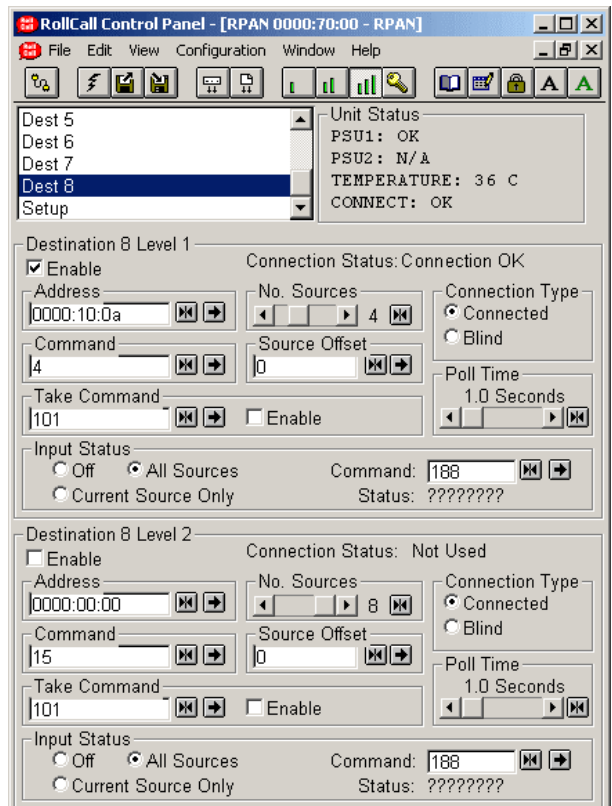

RPAN connected to DMX4. Similar for DMX8/SRT20/SRT21.

Setup

This function allows various system functions to be set up.

Logging

If a logging device is attached to the RollCall network, certain information may be made available for logging.

Server

This item allows the Logging Server to be chosen and set up.

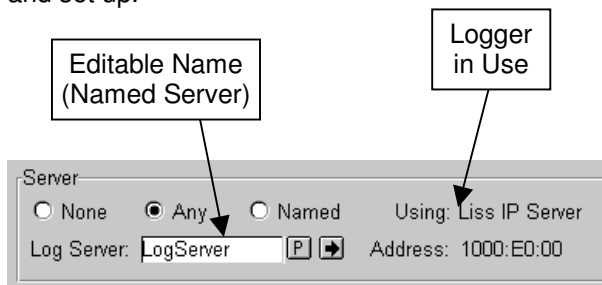

None

If this item is checked the Logging function will be disabled.

Any

If this item is checked Logging information will be sent to any Logger on the system. *It is suggested that if there is only one server on the system, this option should be chosen.*

Named

If this item is checked Logging information will only be sent to the server named in the name window.

Log Server

The Logging Server may be named by editing the text string in the text window.

The **P** symbol represents the Preset function and will return the name to the default name.

Selecting the  symbol will save the new name.

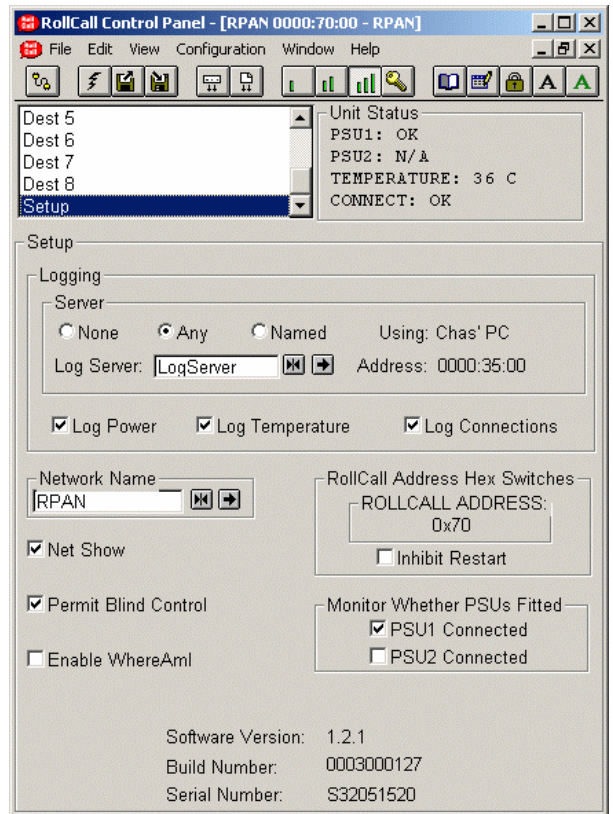

Logging Options

Log Power

If this item is checked the status of the power supplies will be sent to the selected Logger.

Log Temperature

If this item is checked the temperature status of the unit will be sent to the selected Logger.

Log Connections

If this item is checked Source/Destination connection data will be sent to the selected Logger.

Network Name

The Network may be given a name by typing in the text box.

The **P** symbol represents the Preset function and will return the name to the default name.

Selecting the  symbol will save the new name.

Setup (cont)

RollCall Address Hex Switches

When this function is enabled the settings of the Hex switches of the Gateway card will be read and the value shown in the information window.

Inhibit Restart

When this item is checked it will prevent the unit from being restarted whenever the Hex switch settings for the RollCall address are changed.

Netshow

This function allows a unit to be 'hidden' from the network system.

When the box is checked the previously selected unit will not appear in the Module List displayed on other control panels in the system.

When the box is unchecked the unit will appear in the Module List displayed on other control panels in the system.

Note that if a unit is 'hidden' and control is required the unit's address should be changed using the Hex switches on the Remote Control Interface Card.

Permit Blind Control

Blind Control is the ability to control a unit without a connection. Active Front Panels and RollCall PC programs use a RollCall connection to control a module. RollTrack (used for setting, for example, audio delay times to track video delays) does not use a connection, but just sets the delay.

If a chassis fitted with modules which will be controlled by Blind Control (RollTrack and some third party remote control systems) then Permit Blind Control must be enabled.

If Blind Control is not be used then Permit Blind Control may be disabled, giving protection against incorrectly set-up RollTrack source modules.

Enable WhereAml?

When this function is checked the LED indicator on the front panel of the enclosure will flash.

This is useful in a system where there could be a large number of enclosures in a particular area. Sometimes it may be necessary to locate a specific enclosure; this function allows visual identification of the box to be made.

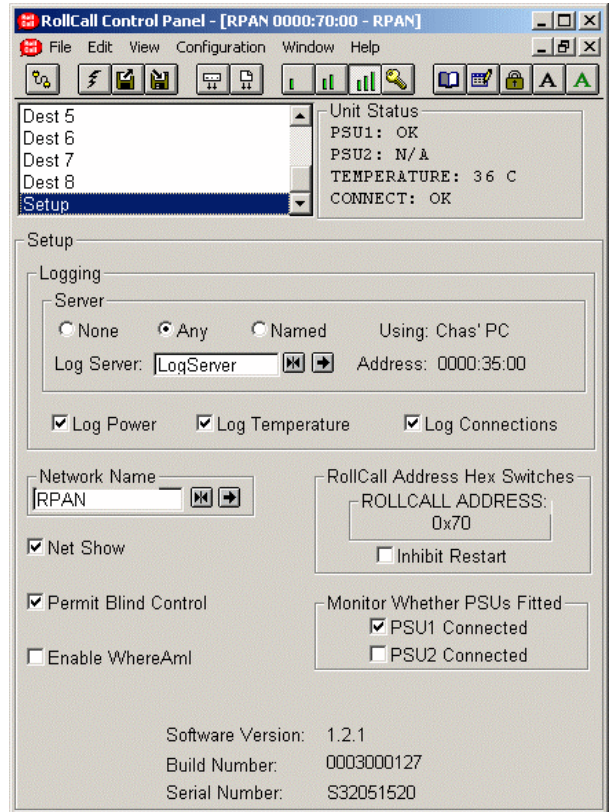

Monitor Whether PSU's Fitted

If two power supply units are fitted (dual redundancy supply configuration) the Left PSU and the Right PSU items should be checked.

If for some reason one of the power supplies is removed a warning will be displayed, indicating which power supply is missing.

If only one power supply is fitted only the corresponding checkbox should be selected and the other cleared.

Software version

This reveals the version number of the software used.

Build Number

This reveals the build number of the hardware used.

Serial Number

This item shows the serial number of the unit.